

ELECTRO SURGICAL



NAWROOZ SURGICAL



**SINGLE USE & REUSABLE
ELECTROSURGICAL INSTRUMENTS**

Email: nawroozsurgical72@gmail.com

Contact: +92 3137879420

ELECTRO SURGICAL



1



2



3



4

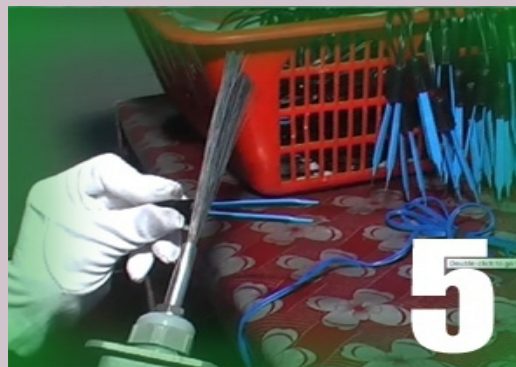

5



6

Company Profile

NAWROOZ SURGICAL is a world leader in development and manufacturing of electro surgical instruments accessories. Our products offering European Bipolar Forceps, US Bipolar Forceps, Mono polar Forceps, Gynecology Instruments Electrodes, Bipolar Cable and other related electro surgical Products.

Our All Instruments are made with high quality stainless steel and coated with special unbreakable and nontoxic nylon material. Our fine instruments are hand crafted for precision and durability.

NAWROOZ SURGICAL Have established a position in the electro surgical arena by offering high quality bipolar, mono-polar instruments and accessories introducing cost effective, single use products, These single use items offer reliable products every time, eliminate processing and repair.cost and provide a forward thinking innovation in electro surgery .

We maintain our mission "to provide our customers with products and services in a timely manner, ".that meets their needs for performance, reliability and safety, at a competitive cost

All Our Electro surgical Instruments are Handmade, why measurements and the best appearance in this catalogue may differ slightly. This catalogue is to the best of our knowledge accurate and correct; however NAWROOZ SURGICAL denies all liabilities are subject to risk due to misprints and/or inaccuracy. All articles in this catalogue are subject to change without notice.

Table of Contents

● European Bipolar Forceps.....	1-6
● European Irrigation Bipolar Forceps.....	7-7
● European Non-Stick Bipolar Forceps.....	8-10
● US Bipolar Forceps.....	11-16
● Monopolar Forceps.....	17-17
● US Irrigation Bipolar Forceps.....	18-18
● US Non-Stick Bipolar Forceps.....	19-20
● Hand-Switch Bipolar Forceps.....	21-21
● Hand-Switch Monopolar Forceps.....	22-22
● Diathermy Instruments.....	23-24
● Disposable Bipolar Forceps.....	25-26
● OB/Gyn Leep Instruments.....	27-29
● OB/Gyn Laser Surgery Instruments.....	30-31
● Laparoscopic & Arthroscopic Electrode.....	32-33
● Electrosurgical Pencil & Electrode.....	34-38
● Electrosurgical Cable.....	39-41
● Bipolar Artery Sealer.....	42-42

01



The NAWROOZ bipolar forceps are available in various lengths and shapes for different surgical and anatomical requirements. The reusable bipolar forceps make it easy to coagulate tissue. Sticking effects on the tips of the forceps are reduced to a minimum.

Advantages of Reusable European Bipolar Forceps

- *Highly polished tips reduce tissue adherence.*
- *Light closing force causes less fatigue over time.*
- *Nylon coating resists abrasion and provides superb insulation.*
- *Precision tip alignment aids fine control.*
- *Reusable, durable, and designed for multiple uses.*
- *The Instruments is autoclavable.*
- *Compatible with all common electrosurgery unit.*

02



381-100

McPherson



381-102

McPherson Ang.



381-104

Jeweller #5 Str



381-106

Jeweller #5 Ang



381-108

Jeweller #7



381-110

Adson

Tip Chart

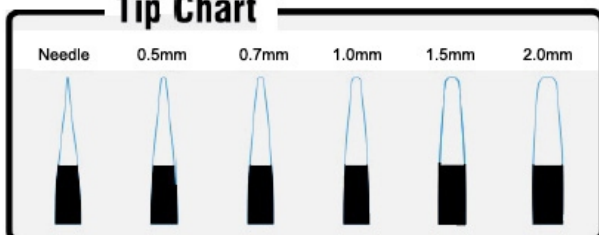

Tip size can be changed as per your requirement, just add the following extensions
fit tip size at the end of Ref #: **TIP**- Needle, 05, 0.7mm, 1.0mm, 1.5mm & 2.0mm

Ref	Item Name	Tip Size (mm)	Length Size (cm)
381-100	McPherson	0.5	10.2
381-102	McPherson Angled	0.5	10.2
381-104	Jeweller #5	0.5, 0.7	11.5
381-106	Jeweller #5 Angled	0.5, 0.7	11.5
381-108	Jeweller #7	0.5, 0.7	11.5
381-110	Adson	1.0	12.0
381-112	Adson	1.0	15.0

03

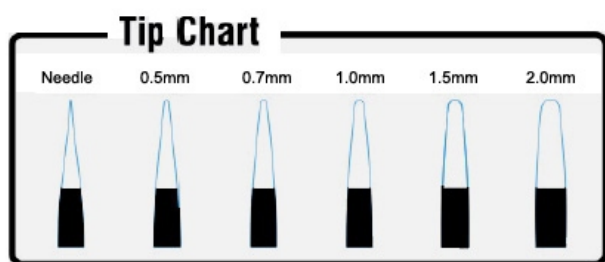
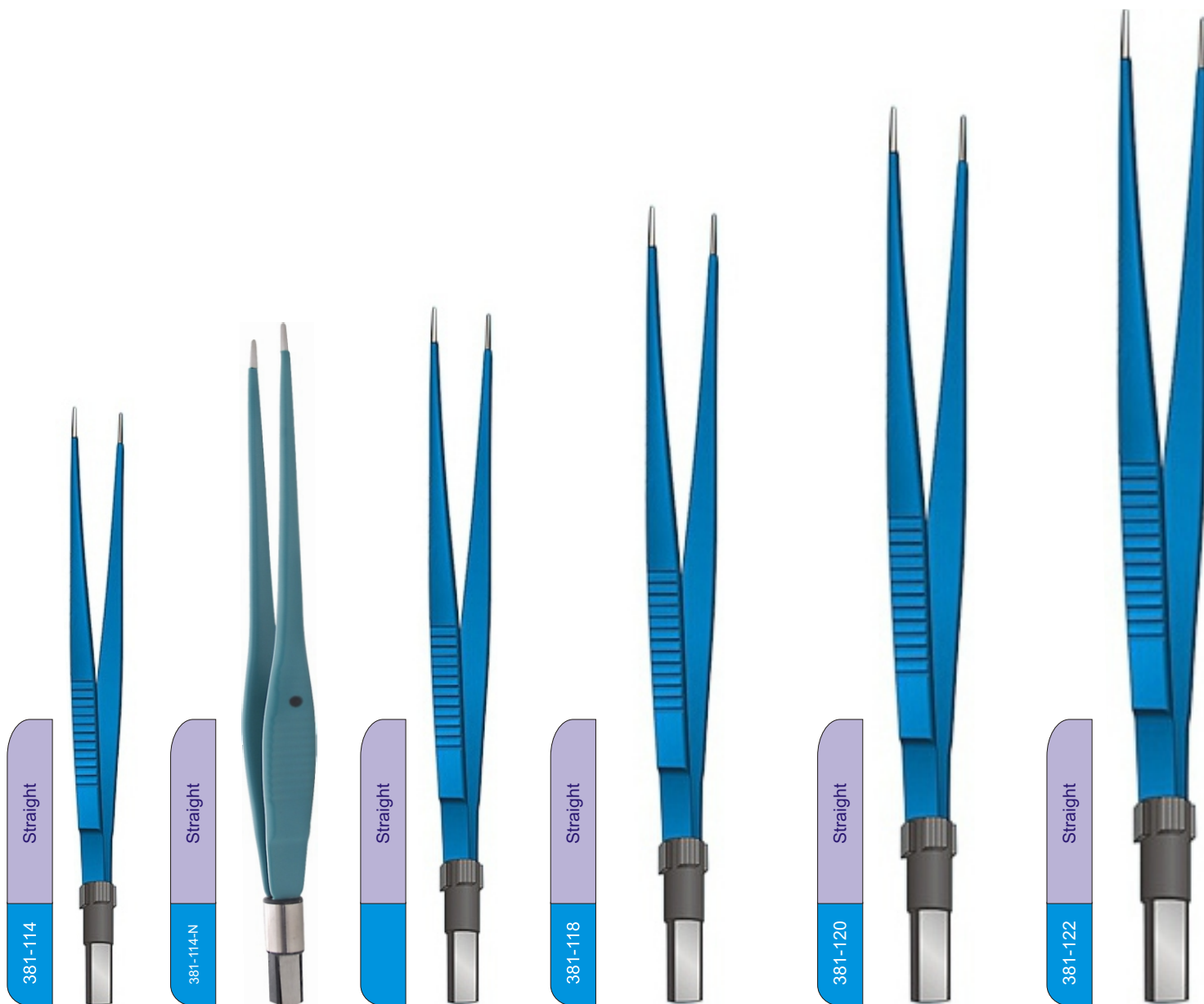

Tip size can be changed as per your requirement, just add the following extensions
fit tip size at the end of Ref #: **TIP-** Needle, 05, 0.7mm, 1.0mm, 1.5mm & 2.0mm

Ref	Item Name	Tip Size (mm)	Length Size (cm)
381-114	Straight	0.5, 1.0, 2.0	15.0
381-114-N	Straight	0.5, 1.0, 2.0	15.0
381-116	Straight	0.5, 1.0, 2.0	18.0
381-118	Straight	0.5, 1.0, 2.0	20.0
381-120	Straight	0.5, 1.0, 2.0	22.0
381-122	Straight	0.5, 1.0, 2.0	24.0

04

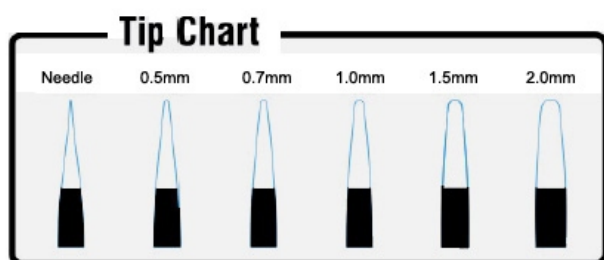

Tip size can be changed as per your requirement, just add the following extensions
fit tip size at the end of Ref #: **TIP**- Needle, 0.5, 0.7mm, 1.0mm, 1.5mm & 2.0mm

Ref	Item Name	Tip Size (mm)	Length Size (cm)
381-124	Straight Angled	0.5, 1.0, 2.0	15.0
381-126	Straight Angled	0.5, 1.0, 2.0	18.0
381-128	Straight Angled	0.5, 1.0, 2.0	20.0
381-130	Straight Angled	0.5, 1.0, 2.0	22.0
381-132	Straight Angled	0.5, 1.0, 2.0	24.0

05



Tip Chart

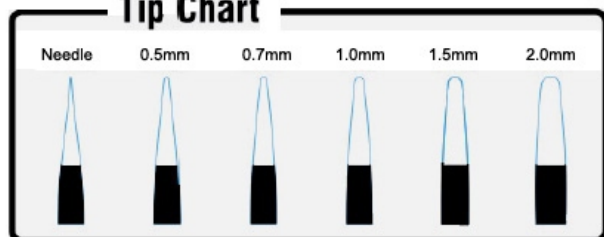

Tip size can be changed as per your requirement, just add the following extensions
fit tip size at the end of Ref #: **TIP**- Needle, 05, 0.7mm, 1.0mm, 1.5mm & 2.0mm

Ref	Item Name	Tip Size (mm)	Length Size (cm)
381-134	Bayonet	0.5, 1.0, 2.0	16.5
381-134-N	Bayonet	0.5, 1.0, 2.0	16.5
381-136	Bayonet	0.5, 1.0, 2.0	18.0
381-138	Bayonet	0.5, 1.0, 2.0	20.0
381-140	Bayonet	0.5, 1.0, 2.0	22.0
381-142	Bayonet	0.5, 1.0, 2.0	24.0

06

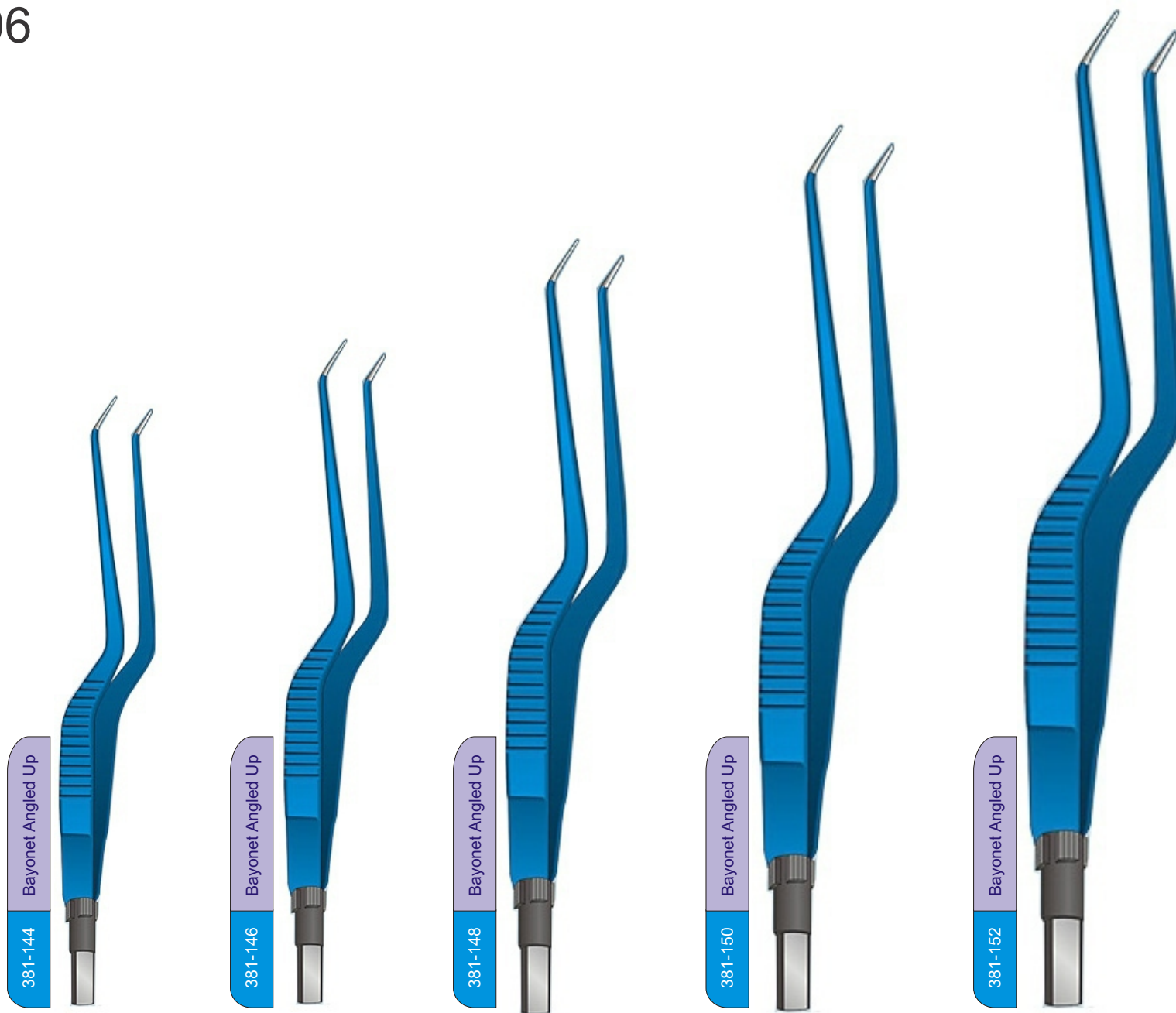

Tip Chart

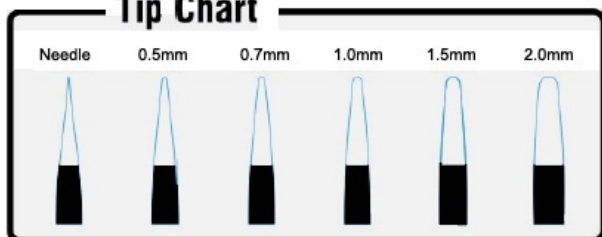

Tip size can be changed as per your requirement, just add the following extensions
fit tip size at the end of Ref #: **TIP**- Needle, 05, 0.7mm, 1.0mm, 1.5mm & 2.0mm

Ref	Item Name	Tip Size (mm)	Length Size (cm)
381-144	Bayonet Angled Up	0.5, 1.0, 2.0	16.5
381-146	Bayonet Angled Up	0.5, 1.0, 2.0	18.0
381-148	Bayonet Angled Up	0.5, 1.0, 2.0	20.0
381-150	Bayonet Angled Up	0.5, 1.0, 2.0	22.0
381-152	Bayonet Angled Up	0.5, 1.0, 2.0	24.0

07



Tip Chart

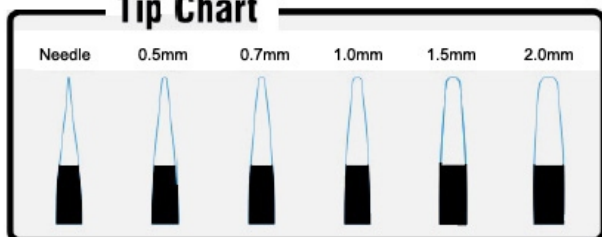

Tip size can be changed as per your requirement, just add the following extensions
fit tip size at the end of Ref #: **TIP**- Needle, 05, 0.7mm, 1.0mm, 1.5mm & 2.0mm

Ref	Item Name	Tip Size (mm)	Length Size (cm)
381-154	Bayonet Angled Down	0.5, 1.0, 2.0	16.5
381-156	Bayonet Angled Down	0.5, 1.0, 2.0	18.0
381-158	Bayonet Angled Down	0.5, 1.0, 2.0	20.0
381-160	Bayonet Angled Down	0.5, 1.0, 2.0	22.0
381-162	Bayonet Angled Down	0.5, 1.0, 2.0	24.0

It is well known that depending on the generator and the surface quality of the forceps jaws, coagulated tissue tends to more or less stick to the instrument jaw. This unwanted effect can occur particularly often with liver tissue and is critical in neurosurgery. For these applications in particular, we have designed our Bipolar Forceps with integrated irrigation channel. The coagulation area is irrigated through a built-in irrigation channel inside the forceps branch which can be connected to a standard irrigation hose. By means of this irrigation the sticking of the tissue is substantially reduced and surgical work is made easier.



Advantages of Reusable European Irrigation Bipolar Forceps

- *A universal hub connector allows irrigation tubing to be connected easily.*
- *The ergonomically designed handle provides less fatigue and a well balanced instrument.*
- *Nylon coating resists abrasion and provides superb insulation.*
- *For high visibility our irrigation tube can be recessed into the forceps blank (buried irrigation).*
- *Compatible with all common electrosurgery unit.*

ELECTRO SURGICAL

09

381-170-IR-N

Bayonet Irrigation



381-170-IR

Bayonet Irrigation



381-168-IR

Bayonet Irrigation



381-166-IR

Straight Irrigation

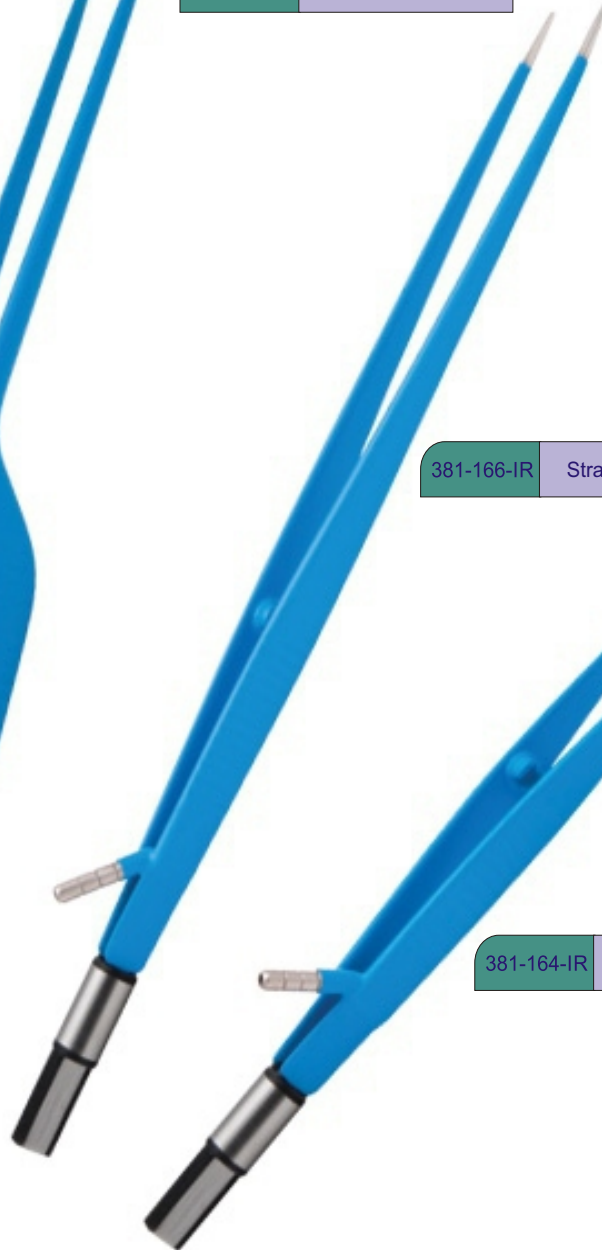

381-164-IR

Straight Irrigation

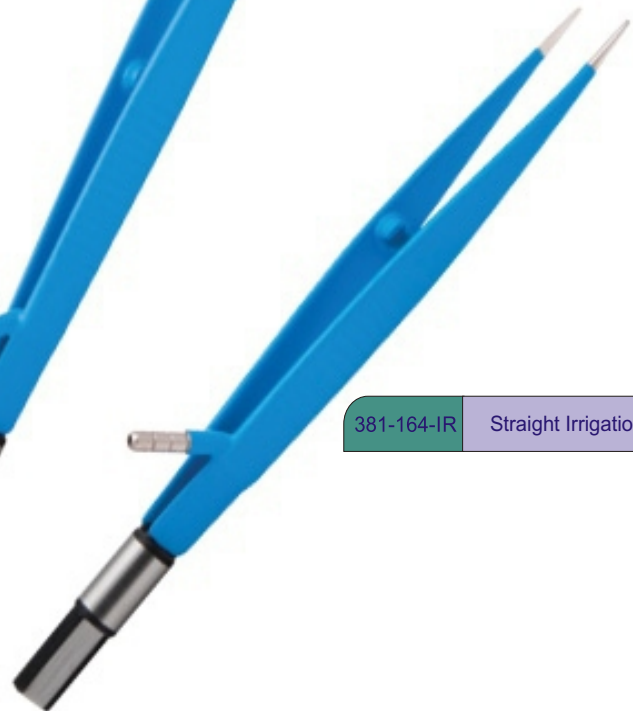

Tip Chart

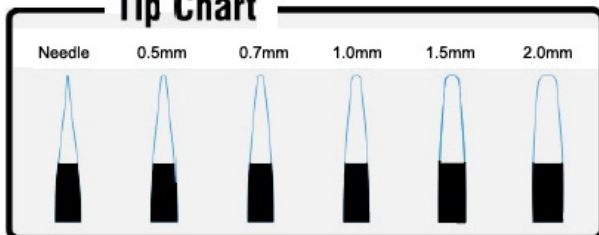

Tip size can be changed as per your requirement, just add the following extensions fit tip size at the end of Ref #: **TIP**- Needle, 0.5, 0.7mm, 1.0mm, 1.5mm & 2.0mm

Ref	Item Name	Tip Size (mm)	Length Size (cm)
381-164-IR	Straight Irrigation	0.5, 1.0, 2.0	18.0
381-166-IR	Straight Irrigation	0.5, 1.0, 2.0	20.0
381-168-IR	Bayonet Irrigation	0.5, 1.0, 2.0	18.0
381-170-IR	Bayonet Irrigation	0.5, 1.0, 2.0	20.0
381-170-IR-N	Bayonet Irrigation	0.5, 1.0, 2.0	20.0

Note: More Bipolar Irrigation Forceps are available use IR extension to any regular bipolar forceps.



During the caagulation process, tissue and tips of forceps can stick together. NAWROOZ non-stick bipolar forceps are made with a special silver alloy and therefore prevent tissue from sticking. Disturbing and time consuming disruptions for cleaning the tips during surgery are thus avoided. Due to the good thermal qualities of silver the temperature of the forceps tips does not exceed 100°C during coagulation, which enhances the non-stick effect. With over ten years of experience we can guarantee that our bipolar forceps do not stick. The non-stick effect remains constant and is not reduced by frequent sterilization. Our non-stick bipolar forceps together with the appropriate connection cables are compatible with all common types of high-frequency units such as Erbe, Martin, Berchtold, Valleylab. NAWROOZ Bipolar forceps non-stick are available in straight, angled or bayonet shape. Available lengths range from 110 to 300 mm. Tips can be made from 0.25 to 2.0 mm width. Forceps are also available with different measurements as well as with flat pin or 2-pin plug.

Advantages of Reusable Non-Stick European Bipolar Forceps

- *Ten years of experience speak for themselves. Our forceps do not stick – never!*
- *No cleaning during surgery*
- *Especially high thermal qualities*
- *All Non-stick Bipolar Forceps are re-usable and autoclavable.*
- *Compatible with all common electrosurgery unit.*

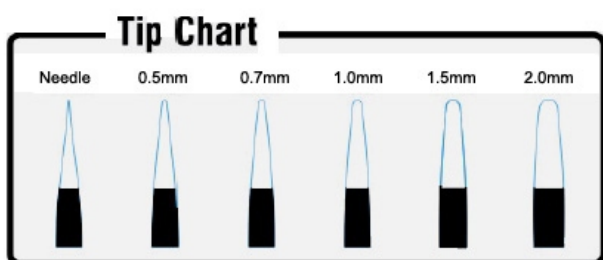

Tip size can be changed as per your requirement, just add the following extensions fit tip size at the end of Ref #: **TIP**: Needle, 05, 0.7mm, 1.0mm, 1.5mm & 2.0mm

Ref	Item Name	Tip Size (mm)	Length Size (cm)
381-172-NS	McPherson	0.5,	10.2
381-174-NS	McPherson Angled	0.5,	10.2
381-176-NS	Jeweller #5	0.5, 0.7	11.5
381-178-NS	Jeweller #5 Angled	0.5, 0.7	11.5
381-180-NS	Adson	1.0	12.0

Note: More Non-Stick Bipolar Forceps are available use NS extension to any regular bipolar forceps.

12

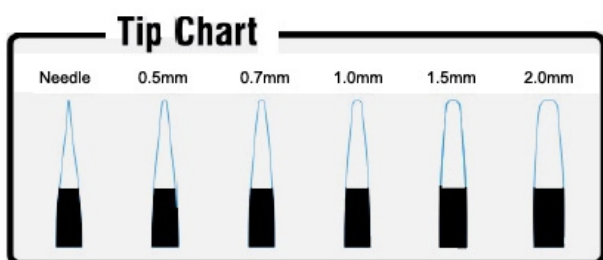

Tip size can be changed as per your requirement, just add the following extensions fit tip size at the end of Ref #: **TIP-** Needle, 05, 0.7mm, 1.0mm, 1.5mm & 2.0mm

Ref		Tip Size (mm)	Length Size (cm)
381-181-NS-N	Straight	0.5, 1.0, 2.0	15.0
381-182-NS	Straight	0.5, 1.0, 2.0	15.0
381-184-NS	Straight	0.5, 1.0, 2.0	18.0
381-186-NS	Straight	0.5, 1.0, 2.0	20.0
381-188-NS	Straight	0.5, 1.0, 2.0	22.0

Note: More Non-Stick Bipolar Forceps are available use NS extension to any regular bipolar forceps.

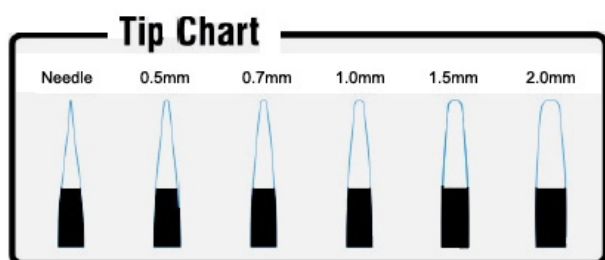

Tip size can be changed as per your requirement, just add the following extensions fit tip size at the end of Ref #: **TIP-** Needle, 0.5, 0.7mm, 1.0mm, 1.5mm & 2.0mm

Ref	Item Name	Tip Size (mm)	Length Size (cm)
381-190-NS	Bayonet	0.5, 1.0, 2.0	16.5
381-190-NS-N	Bayonet	0.5, 1.0, 2.0	16.5
381-192-NS	Bayonet	0.5, 1.0, 2.0	18.0
381-194-NS	Bayonet	0.5, 1.0, 2.0	20.0
381-196-NS	Bayonet	0.5, 1.0, 2.0	22.0

Note: More Non-Stick Bipolar Forceps are available use NS extension to any regular bipolar forceps.



The NAWROOZ bipolar forceps are available in various lengths and shapes for different surgical and anatomical requirements. The reusable Bipolar forceps make it easy to coagulate tissue. Sticking effects on the tips of the .forceps are reduced to a minimum

Advantages of Reusable US Bipolar Forceps

- *Highly polished tips reduce tissue adherence.*
- *Light closing force causes less fatigue over time.*
- *Nylon coating resists abrasion and provides superb insulation.*
- *Reusable, durable, and designed for multiple uses.*
- *Precision tip alignment aids fine control.*
- *The Instruments is atoclavable.*
- *Compatible with all common electrosurgery unit.*

15

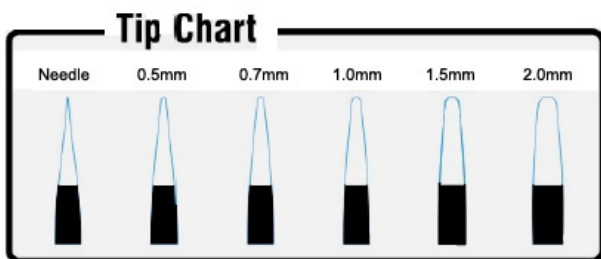
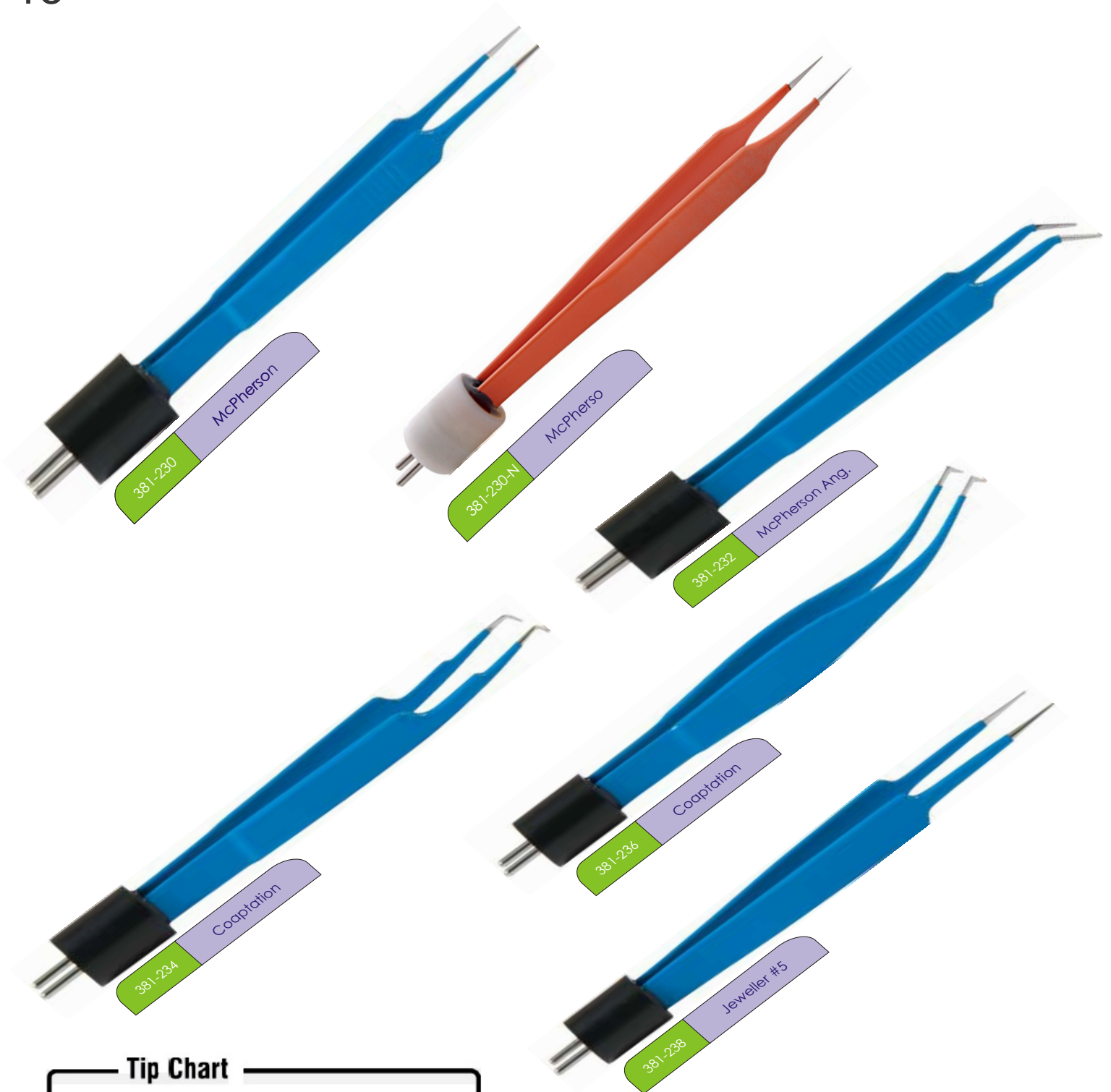

Tip size can be changed as per your requirement, just add the following extensions fit tip size at the end of Ref #: **TIP-** Needle, 0.5, 0.7mm, 1.0mm, 1.5mm & 2.0mm

Ref	Item Name	Tip Size (mm)	Length Size (cm)
381-230	McPherson	0.5	10.2
381-230-N	McPherson	0.5	10.2
381-232	McPherson Angled	0.5	10.2
381-234	Coaptation Nedler	0.5	10.2
381-236	Coaptation	0.5	10.8
381-238	Jeweller #5	Needle, 0.5	11.5

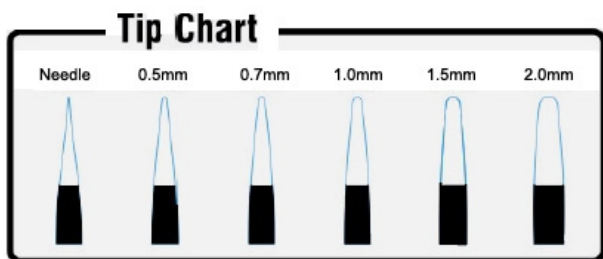
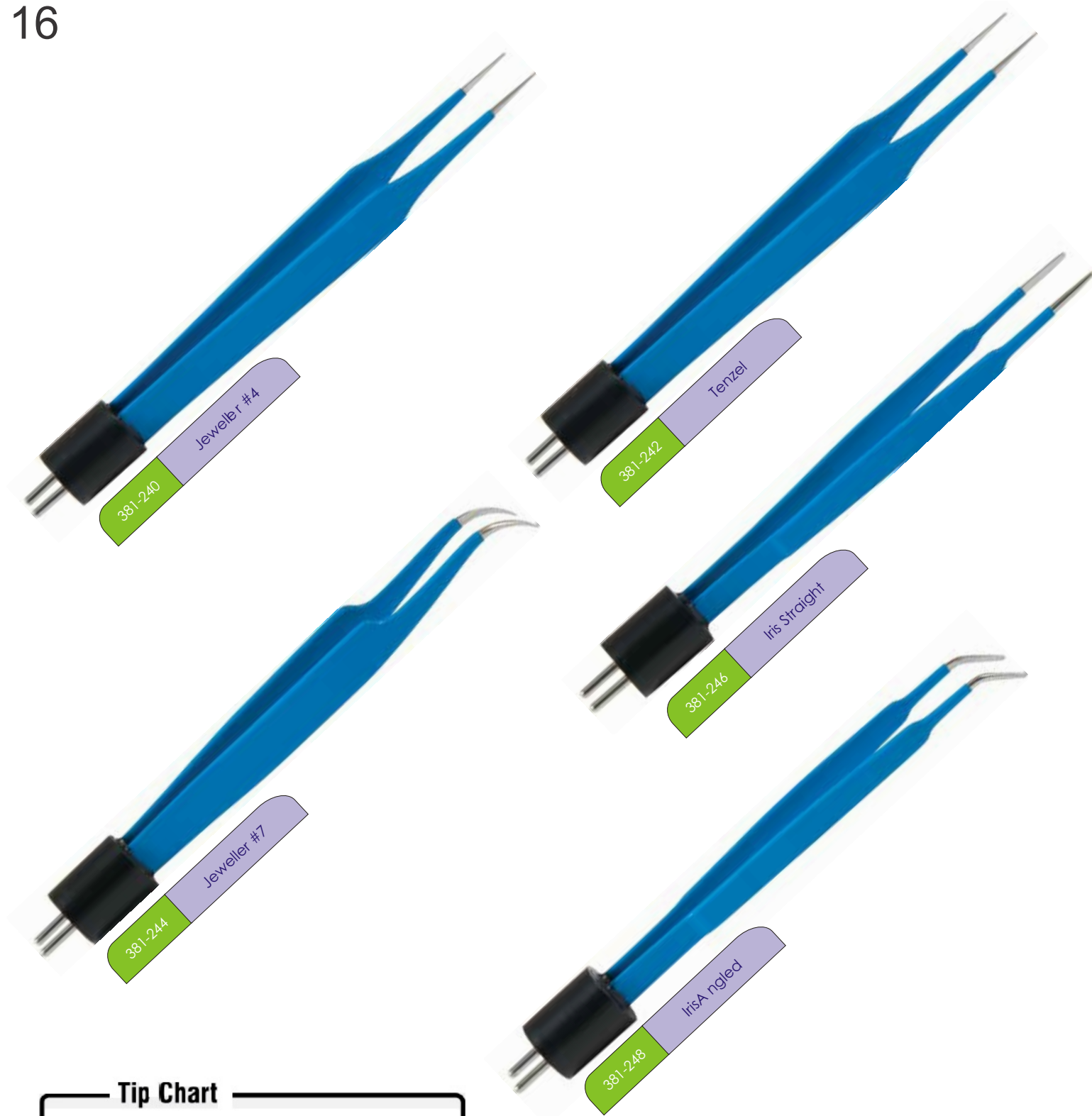

Tip size can be changed as per your requirement, just add the following extensions
fit tip size at the end of Ref #: TIP- Needle, 0.5, 0.7mm, 1.0mm, 1.5mm & 2.0mm

Ref	Item Name	Tip Size (mm)	Length Size (cm)
381-240	Jeweller #4	Needle, 0.5	11.5
381-242	Tenzel	Needle, 0.5	10.2
381-244	Jeweller #7	Needle, 0.5	11.5
381-246	Iris Straight	Needle, 0.5	10.8
381-248	Iris Angled	0.5, 1.0	10.8

17

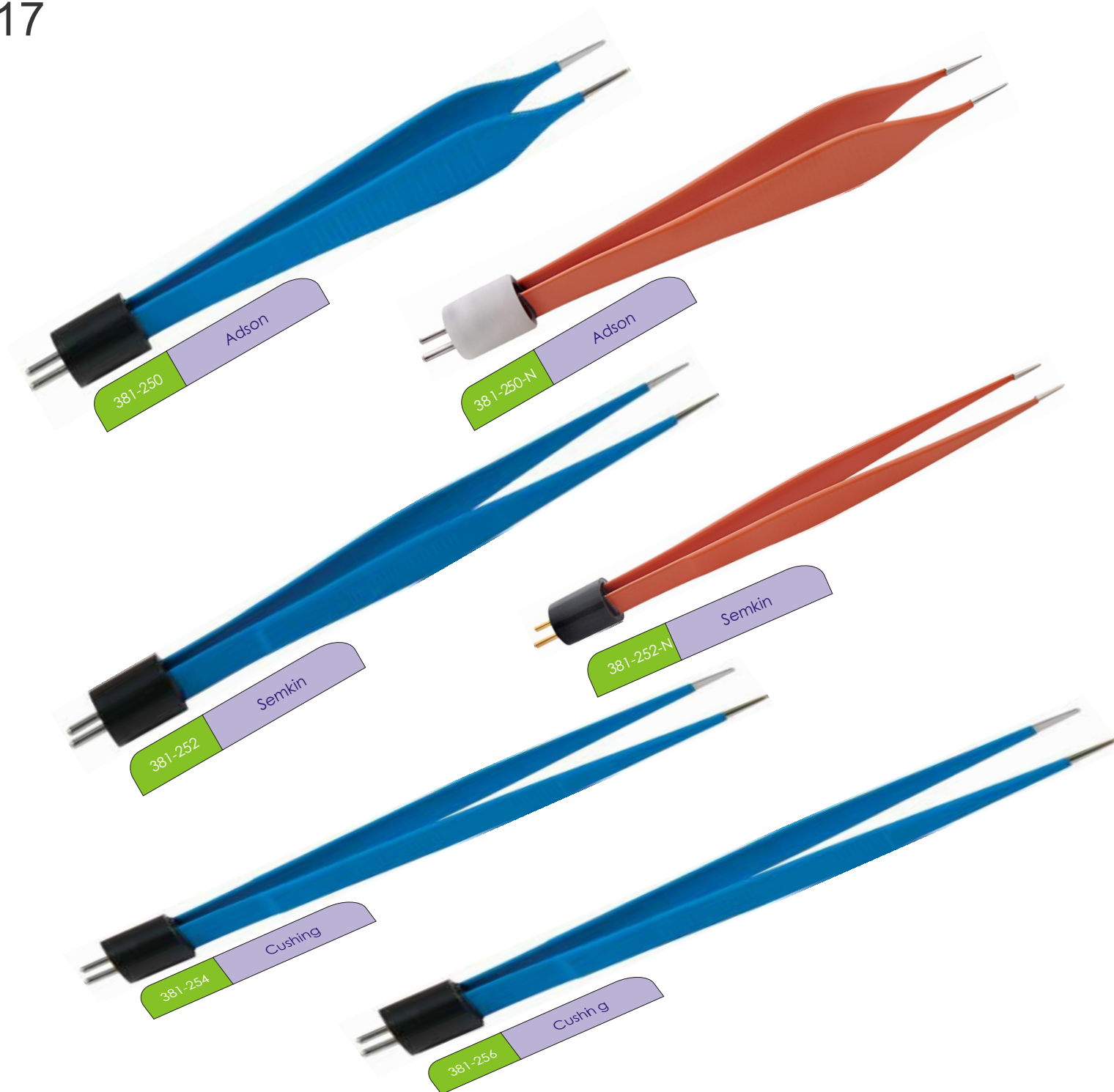

Tip Chart

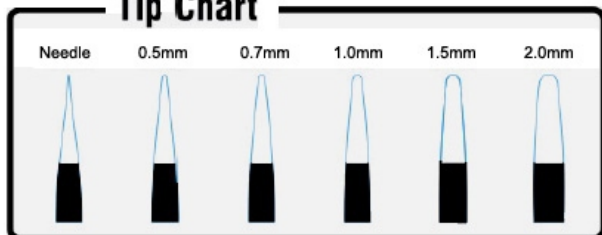

Tip size can be changed as per your requirement, just add the following extensions fit tip size at the end of Ref #: **TIP**- Needle, 0.5, 0.7mm, 1.0mm, 1.5mm & 2.0mm

Ref	Item Name	Tip Size (mm)	Length Size (cm)
381-250	Adson	1.0	12.0
381-250-N	Adson	1.0	12.0
381-252	Semkin	0.5, 1.0	14.0
381-252-N	Semkin	0.5, 1.0	14.0
381-254	Cushing	1.0, 1.5, 2.0	15.9
381-256	Cushing	1.0, 1.5, 2.0	17.8

18

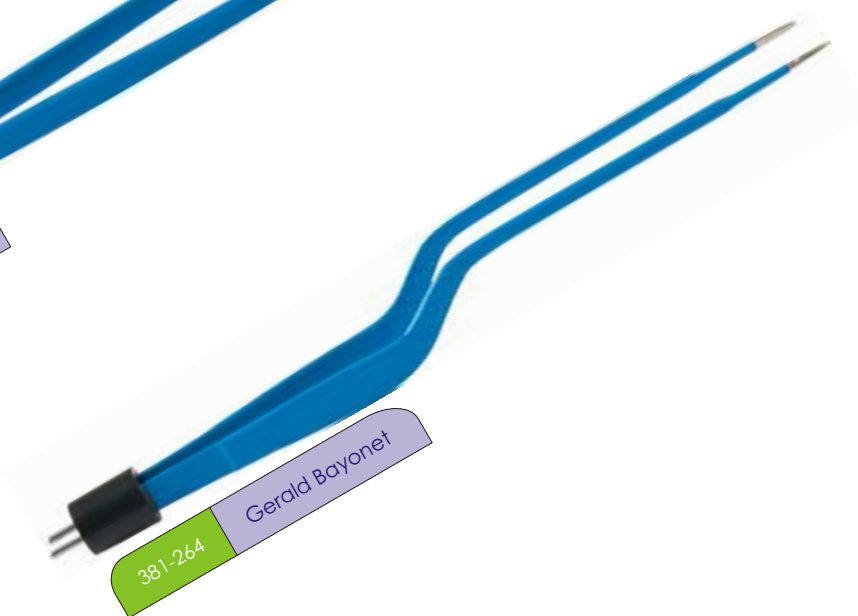
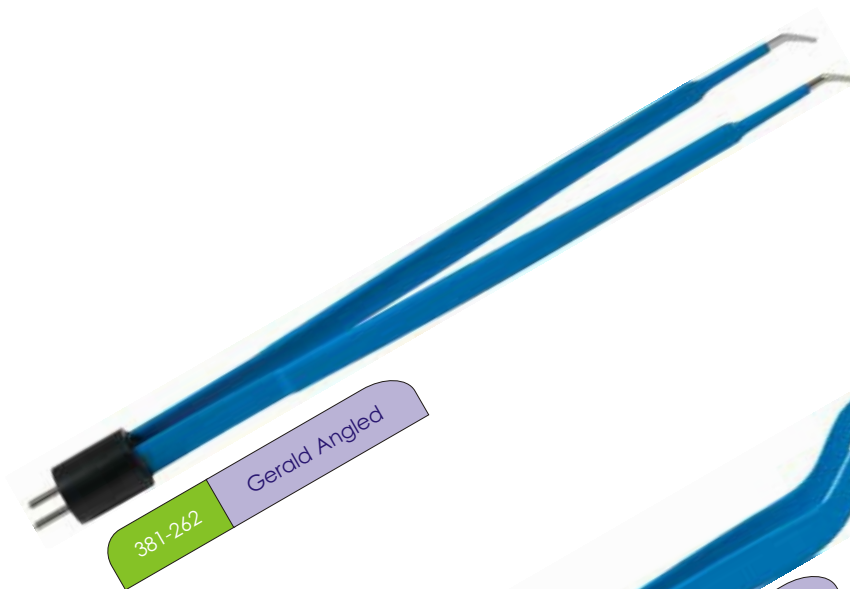
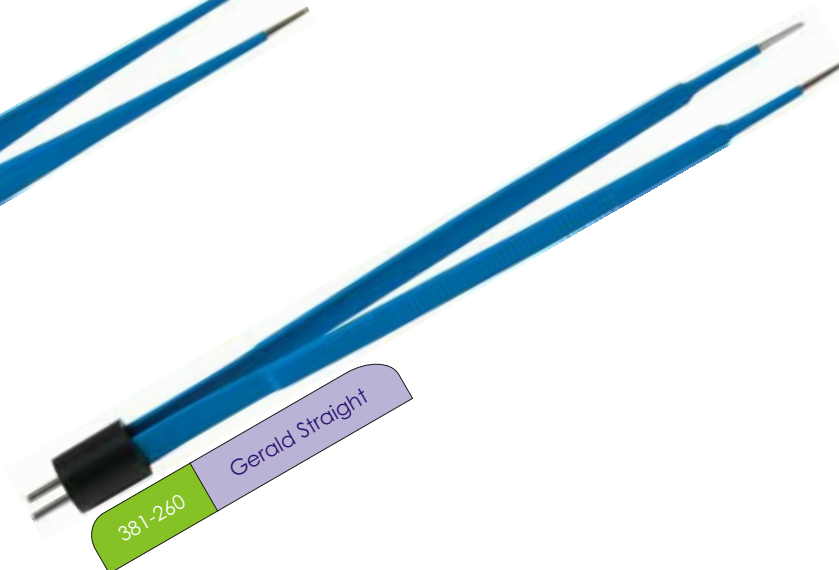
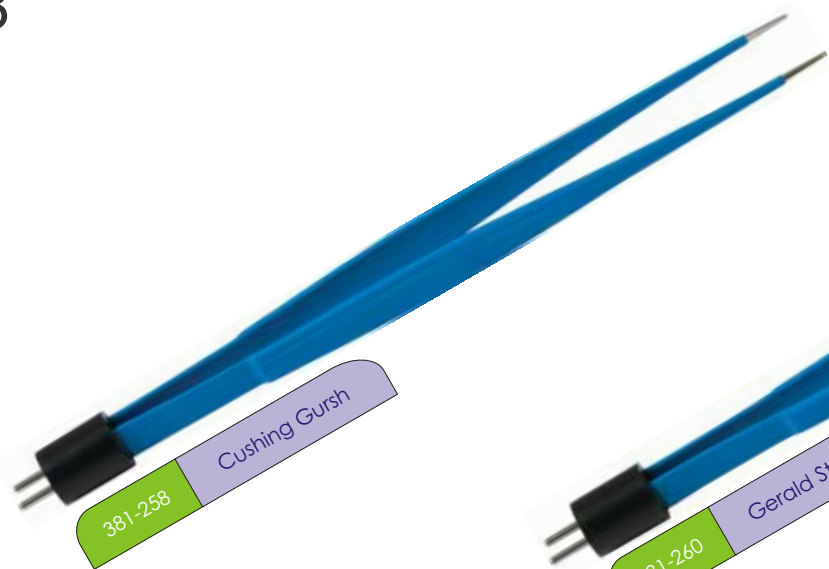

Tip Chart

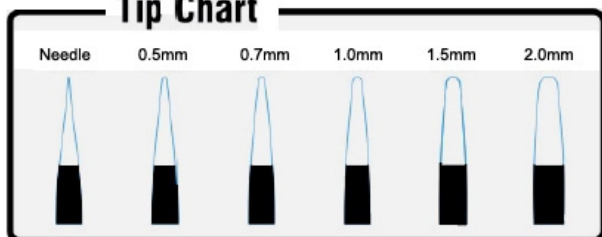

Tip size can be changed as per your requirement, just add the following extensions
fit tip size at the end of Ref #: TIP- Needle, 0.5, 0.7mm, 1.0mm, 1.5mm & 2.0mm

Ref	Item Name	Tip Size (mm)	Length Size (cm)
381-258	Cushing Gursh	1.0, 1.5, 2.0	17.8
381-260	Gerald Straight	1.0, 1.5, 2.0	17.8
381-262	Gerald Angled	1.0, 1.5, 2.0	17.8
381-264	Gerald Bayonet	1.0, 1.5, 2.0	18.4

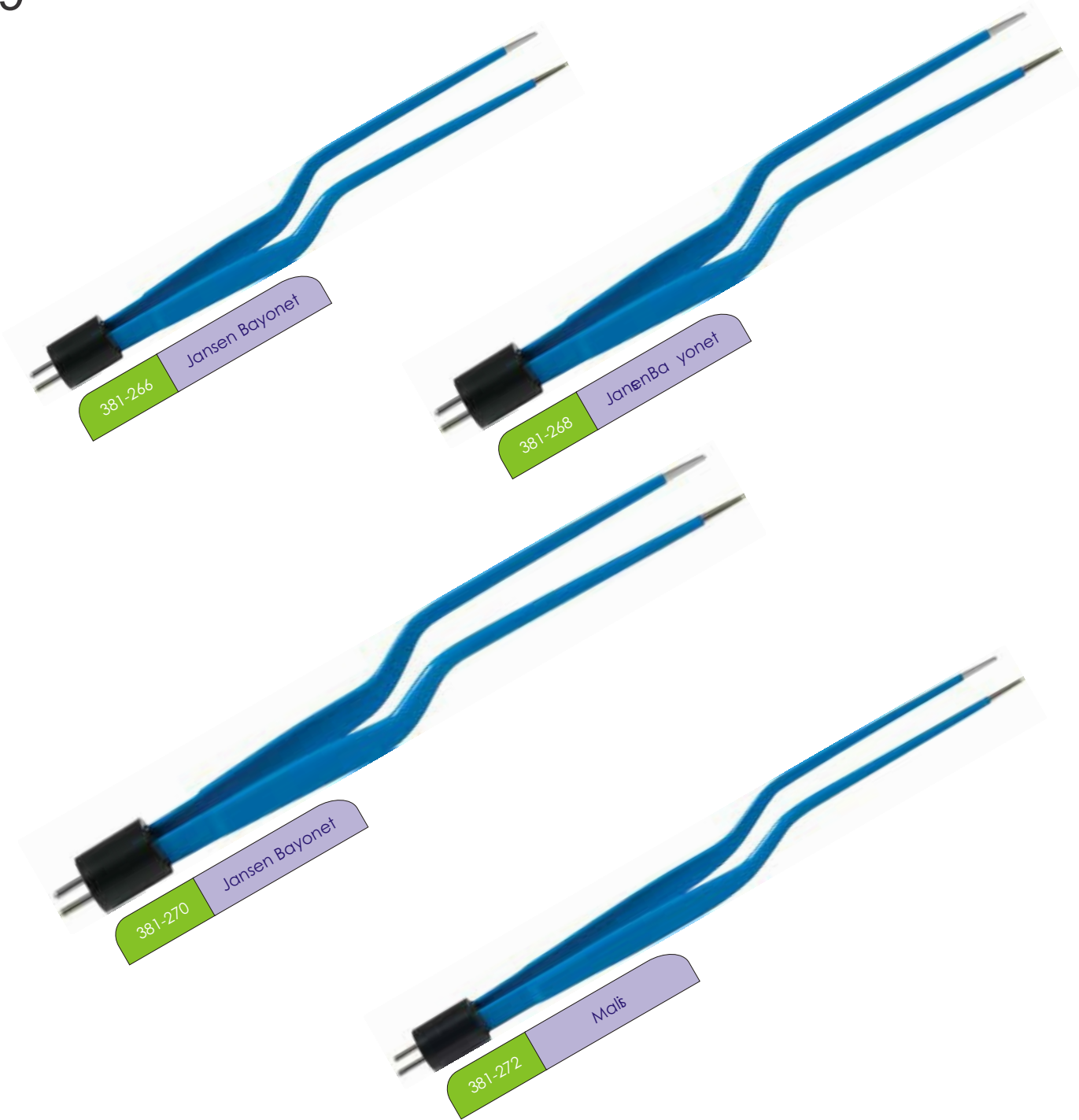

Tip Chart

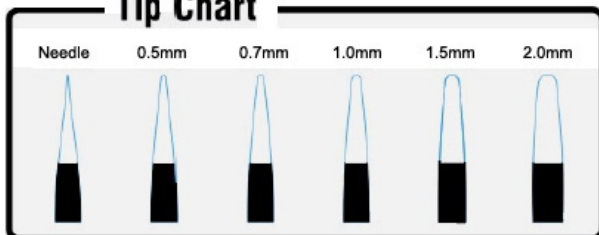

Tip size can be changed as per your requirement, just add the following extensions fit tip size at the end of Ref #: TIP- Needle, 0.5, 0.7mm, 1.0mm, 1.5mm & 2.0mm

Ref	Item Name	Tip Size (mm)	Length Size (cm)
381-266	Jansen Bayonet	1.0, 1.5, 2.0	15.2
381-268	Jansen Bayonet	1.0, 1.5, 2.0	17.8
381-270	Jansen Bayonet	1.0, 1.5, 2.0	20.4
381-272	Malis	1.0, 1.5, 2.0	17.8

20

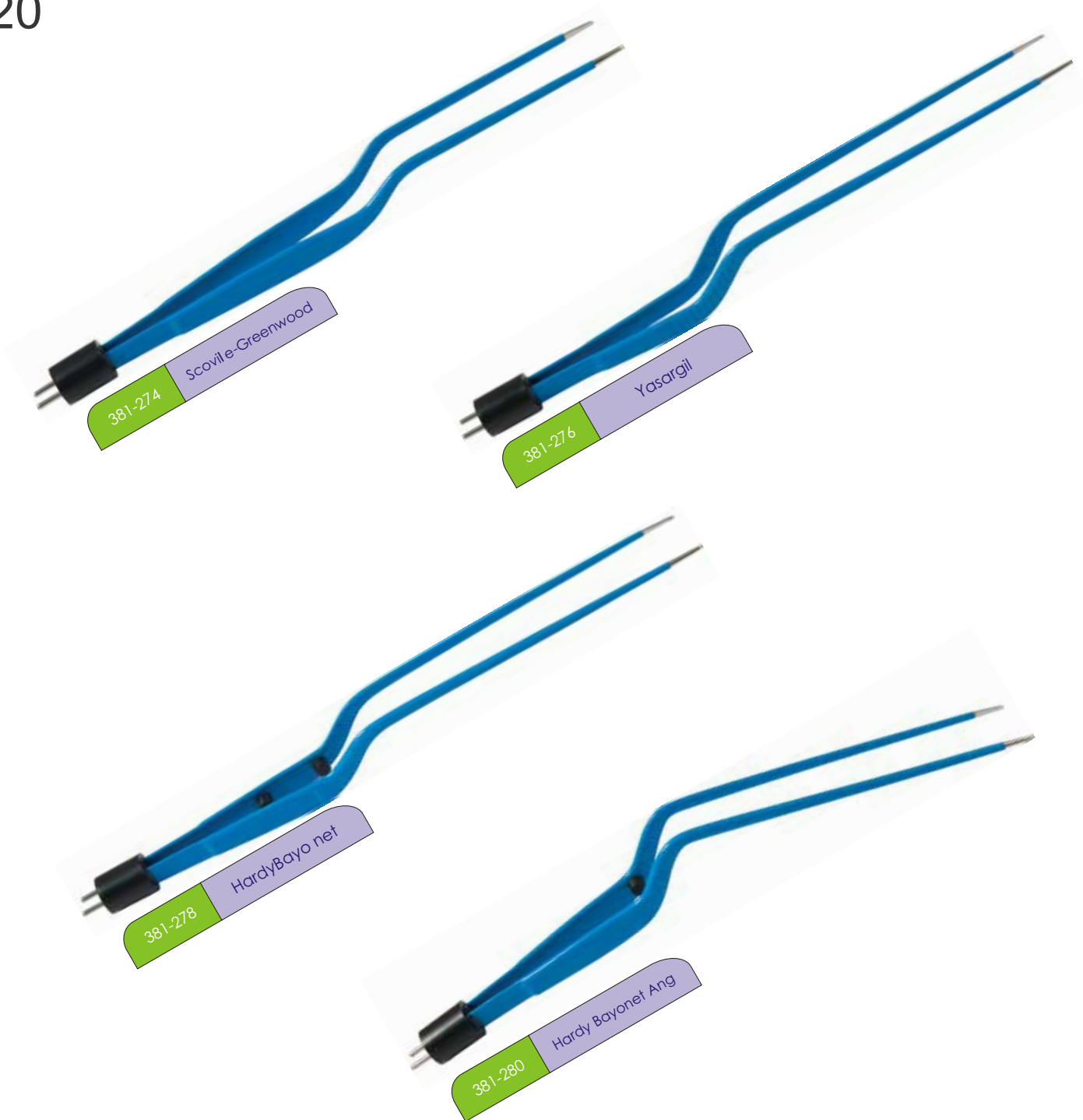

Tip Chart

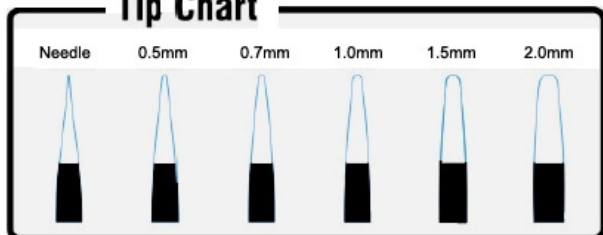

Tip size can be changed as per your requirement, just add the following extensions
fit tip size at the end of Ref #: **TIP**- Needle, 05, 0.7mm, 1.0mm, 1.5mm & 2.0mm

Ref	Item Name	Tip Size (mm)	Length Size (cm)
381-274	Scoville-Greenwood	1.0, 1.5	19.1
381-276	Yasargil	1.0, 1.5	19.7
381-278	Hardy Bayonet	1.0, 1.5	21.6
381-280	Hardy Bayonet Angled	1.0, 1.5	21.6



Our Monopolar instruments are tested at high volts to ensure proper functioning during the most stringent operations. With the best quality stainless steel, excellent finishing and superior insulation, we provide worldwide guarantee for all our Monopolar instruments.

Advantages of Reusable Monopolar Forceps

- *Lightweight and well balanced to prevent fatigue.*
- *Highly polished tips minimise sticking.*
- *Nylon coating resists abrasion and provides superb insulation.*
- *Precision tip alignment aids fine control.*
- *Compatible with all common electrosurgery unit.*

ELECTRO SURGICAL

22

381-282 Jeweller #4



381-284 Jeweller #7



381-286 Adson



381-288 Potts-Smith



381-292 Potts-Smith



381-294 Jansen Bayonet



381-296 Jansen Bayonet



381-302 Jansen Bayonet UP

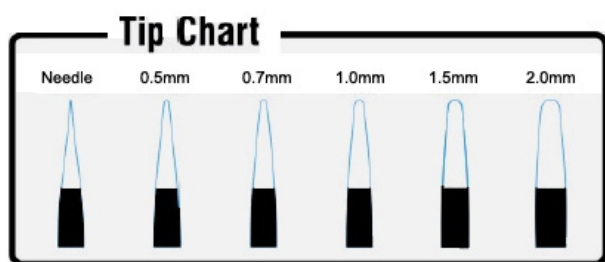

Tip size can be changed as per your requirement, just add the following extensions
fit tip size at the end of Ref #: TIP- Needle, 0.5, 0.7mm, 1.0mm, 1.5mm & 2.0mm

Ref	Item Name	Tip Size (mm)	Length Size (cm)
381-282	Jeweller #4	Needle	11.5
381-284	Jeweller #7	Needle	11.5
381-286	Adson	1.0	12.0
381-288	Potts-Smith	2.0	17.8
381-290	Potts-Smith	2.0	21.0
381-292	Potts-Smith	2.0	24.1
381-294	Jansen Bayonet	1.5	13.3
381-296	Jansen Bayonet	1.5	15.9
381-298	Jansen Bayonet	2.0	19.1
381-300	Jansen Bayonet	2.0	21.0
381-302	Jansen Bayonet UP	2.0	19.1
381-304	Jansen Bayonet UP	2.0	21.0



It is well known that depending on the generator and the surface quality of the forceps jaws, coagulated tissue tends to more or less stick to the instrument jaw. This unwanted effect can occur particularly often with liver tissue and is critical in neurosurgery. For these applications in particular, we have designed our Bipolar Forceps with integrated irrigation channel. The coagulation area is irrigated through a built-in irrigation channel inside the forceps branch which can be connected to a standard irrigation hose. By means of this irrigation the sticking of the tissue is substantially reduced and surgical work is made easier.

Advantages of Reusable US Irrigation Forceps

- *A universal hub connector allows irrigation tubing to be connected easily.*
- *The ergonomically designed handle provides less fatigue and a well balanced instrument.*
- *For high visibility our irrigation tube can be recessed into the forceps blank (buried irrigation).*
- *Compatible with all common electrocautery unit.*



381-306-IR Hardy Bayonet



381-308-IR Jansen Bayonet



381-308-IR-N Jansen Bayonet



381-310-IR Scoville-Greenwood



381-312-IR Gerald Bayonet



381-314-IR Straight

Tip Chart

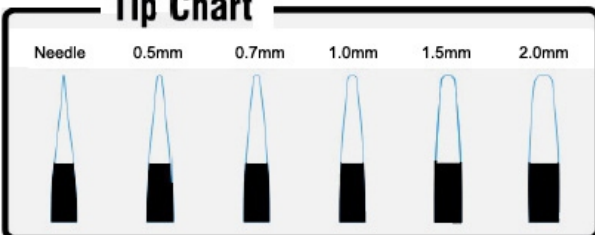

Tip size can be changed as per your requirement, just add the following extensions fit tip size at the end of Ref #: TIP- Needle, 0.5, 0.7mm, 1.0mm, 1.5mm & 2.0mm

Ref	Item Name	Tip Size (mm)	Length Size (cm)
381-306-IR	Hardy Bayonet	0.5, 1.0, 1.5	21.6
381-308-IR	Jansen Bayonet	0.5, 1.0, 1.5	19.1
381-308-IR-N	Jansen Bayonet	0.5, 1.0, 1.5	19.1
381-310-IR	Scoville-Greenwood	0.5, 1.0, 1.5	19.7
381-312-IR	Gerald Bayonet	0.5, 1.0, 1.5	18.4
381-314-IR	Straight	0.5, 1.0, 1.5	15.9

Note: More Irrigation Bipolar Forceps are available use IR extension to any regular bipolar forceps.



During the caagulation process, tissue and tips of forceps can stick together. NAWROOZ non-stick bipolar forceps are made with a special silver alloy and therefore prevent tissue from sticking. Disturbing and time consuming disruptions for cleaning the tips during surgery are thus avoided. Due to the good thermal qualities of silver the temperature of the forceps tips does not exceed 100°C during coagulation, which enhances the non-stick effect. With over ten years of experience we can guarantee that our bipolar forceps do not stick. The non-stick effect remains constant and is not reduced by frequent sterilization. Our non-stick bipolar forceps together with the appropriate connection cables are compatible with all common types of high-frequency units such as Erbe, Martin, Berchtold, Valleylab. NAWROOZ Bipolar forceps non-stick are available in straight, angled or bayonet shape. Available lengths range from 110 to 300 mm. Tips can be made from 0.25 to 2.0 mm width. Forceps are also available with different measurements as well as with flat pin or 2-pin plug.

Advantages of Reusable Non-Stick European Bipolar Forceps

- *Ten years of experience speak for themselves. Our forceps do not stick – never!*
- *No cleaning during surgery*
- *Especially high thermal qualities*
- *All Non-stick Bipolar Forceps are re-usable and autoclavable.*
- *Compatible with all common electrosurgery unit.*

ELECTRO SURGICAL

26



381-316-NS-N McPherson



381-316-NS McPherson



381-318-NS McPherson Angled



381-320-NS Jeweller #5



381-322-NS Jeweller #4



381-324-NS Adson



381-326-NS Semkin

Tip Chart

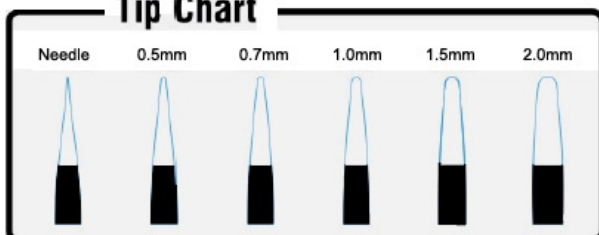

Tip size can be changed as per your requirement, just add the following extensions fit tip size at the end of Ref #: TIP- Needle, 0.5, 0.7mm, 1.0mm, 1.5mm & 2.0mm

Ref	Item Name	Tip Size (mm)	Length Size (cm)
381-316-NS	McPherson	0.5	10.2
381-316-NS-N	McPherson	0.5	10.2
381-318-NS	McPherson Angled	0.5	10.2
381-320-NS	Jeweller #5	Needle, 0.5	11.5
381-322-NS	Jeweller #4	Needle, 0.5	11.5
381-324-NS	Adson	1.0	12.0
381-326-NS	Semkin	0.5, 1.0	14.0

Note: More Non-Stick Bipolar Forceps are available use NS extension to any regular bipolar forceps.

ELECTRO SURGICAL

27



381-328-NS

Cushing



381-332-NS

Gerald Bayonet



381-334-NS

Jansen Bayonet



381-336-NS

Scoville-Greenwood



381-338-NS

Yasargil



381-340-NS

Hardy Bayonet

Tip Chart

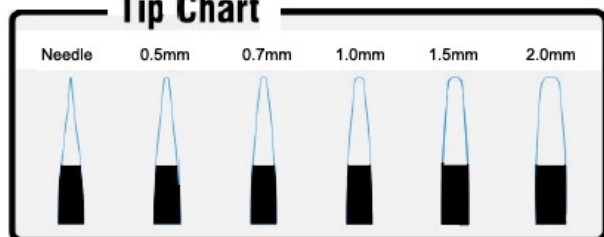

Tip size can be changed as per your requirement, just add the following extensions fit tip size at the end of Ref #: **TIP**- Needle, 05, 0.7mm, 1.0mm, 1.5mm & 2.0mm

Ref	Item Name	Tip Size (mm)	Length Size (cm)
381-328-NS	Cushing	1.0, 1.5, 2.0	15.9
381-330-NS	Cushing	1.0, 1.5, 2.0	17.8
381-332-NS	Gerald Bayonet	1.0, 1.5	18.4
381-334-NS	Jansen Bayonet	1.0, 1.5	15.9
381-336-NS	Scoville-Greenwood	1.0, 1.5	19.1
381-338-NS	Yasargil	1.0, 1.5	19.7
381-340-NS	Hardy Bayonet	1.0, 1.5	21.6

Note: More Non-Stick Bipolar Forceps are available use NS extension to any regular bipolar forceps.

381-342-HS Semkin

381-341-HS Jeweller #4

381-343-HS Jansen Bayonet

381-344-HS Scoville-Greenwood



Tip Chart

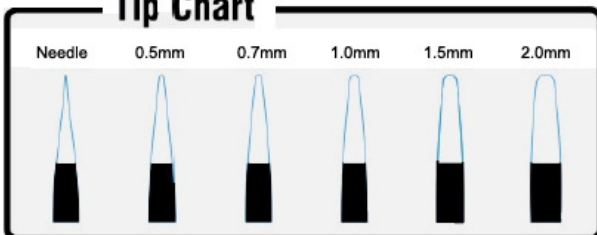

Tip size can be changed as per your requirement, just add the following extensions
fit tip size at the end of Ref #: TIP- Needle, 05, 0.7mm, 1.0mm, 1.5mm & 2.0mm

Ref	Item Name	Tip Size (mm)	Length Size (cm)
381-341-HS	Jeweller #4	0.5	11.5
381-342-HS	Semkin	0.7	14.0
381-343-HS	Jansen Bayonet	0.7	19.1
381-344-HS	Scoville-Greenwood	1.5	19.7

381-345-HS

Jansen Bayonet



381-346-HS

Jansen Bayonet



381-347-HS

Potts-Smith



381-348-HS

Potts-Smith

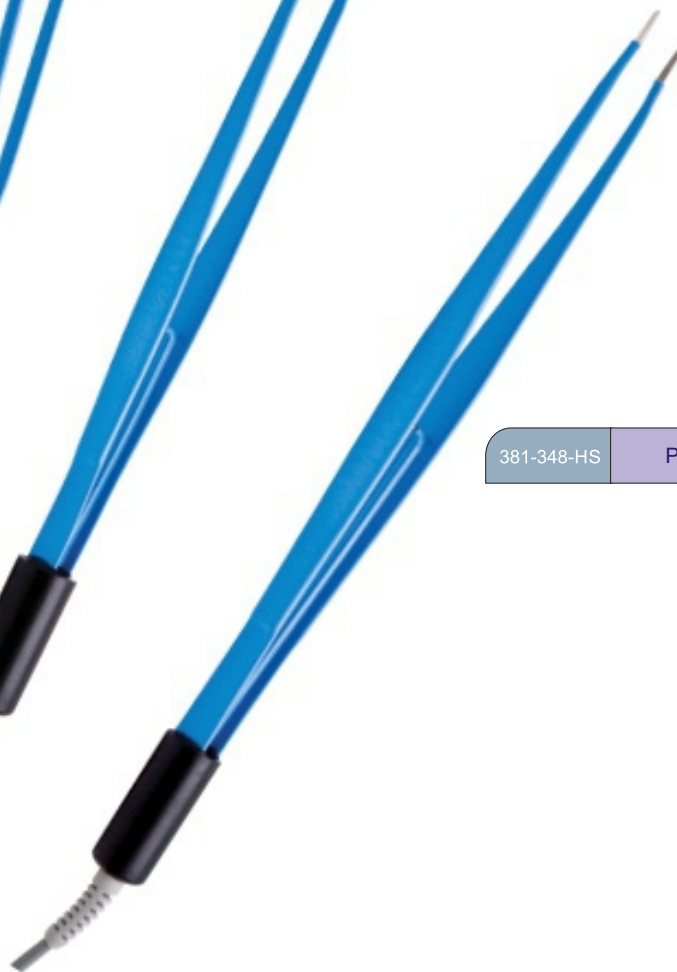

Tip Chart

Needle	0.5mm	0.7mm	1.0mm	1.5mm	2.0mm

Tip size can be changed as per your requirement, just add the following extensions
fit tip size at the end of Ref #: TIP- Needle, 05, 0.7mm, 1.0mm, 1.5mm & 2.0mm

Ref	Item Name	Tip Size (mm)	Length Size (cm)
381-345-HS	Jansen Bayonet	2.0	19.0
381-346-HS	Jansen Bayonet	2.0	21.0
381-347-HS	Potts-Smith	2.0	21.0
381-348-HS	Potts-Smith	2.0	24.0



Our Diathermy instruments are tested at high volts to ensure proper functioning during the most stringent operations. With the best quality stainless steel, excellent finishing and superior insulation, we provide worldwide guarantee for all our Diathermy instruments. Diathermy instruments are available in four base types. Models popular Diathermy Instruments : Adson, Jeweller, McIndoe, Standard, Bayonet, Artery Forceps, Wilson Hey Forceps, Diathermy Scissors, etc in various lengths, tip sizes, and 4 plug types

Advantages of Reusable Diathermy Instruments

- *Lightweight and well balanced to prevent fatigue.*
- *Highly polished tips minimise sticking.*
- *Precision tip alignment aids fine control.*
- *Compatible with all common electrosurgery unit.*

31



Tuner Warwick Scissors (STR)
381-350



Tuner Warwick Scissors (CRV)
381-352



Dressing Scissors (STR)
381-358



Dressing Scissors (CRV)
381-360



Wilson Hay Forceps (STR)
381-366



Wilson Hay Forceps (CRV)
381-368



Artery Forceps (STR)
381-374



Artery Forceps (CRV)
381-376



Abbey Needle
381-382



Richie Forceps
381-384

ENGLISH MONOPOLAR MALE 4.8MM CONNECTOR

Ref	Item Name	Tip Size (mm)	Length Size (cm)
381-350	Tuner Warwick Scissors (STR)	-	17.8
381-352	Tuner Warwick Scissors (CRV)	-	17.8
381-354	Tuner Warwick Scissors (STR)	-	23.0
381-356	Tuner Warwick Scissors (CRV)	-	23.0
381-358	Dressing Scissors (STR)	-	17.8
381-360	Dressing Scissors (CRV)	-	17.8
381-362	Dressing Scissors (STR)	-	23.0
381-364	Dressing Scissors (CRV)	-	23.0
381-366	Wilson Hay Forceps (STR)	-	17.8
381-368	Wilson Hay Forceps (CRV)	-	17.8
381-370	Wilson Hay Forceps (STR)	-	23.0
381-372	Wilson Hay Forceps (CRV)	-	23.0
381-374	Artery Forceps (STR)	-	17.8
381-376	Artery Forceps (CRV)	-	17.8
381-378	Artery Forceps (STR)	-	23.0
381-380	Artery Forceps (CRV)	-	23.0
381-382	Abbey Needle	-	17.5
381-384	Richie Forceps	-	17.8
381-386	Richie Forceps	-	20.0
381-388	Richie Forceps	-	23.0

EUROPEAN MONOPOLAR FEMALE 4.0MM CONNECTOR

Ref	Item Name	Tip Size (mm)	Length Size (cm)
381-390	Tuner Warwick Scissors (STR)	-	17.8
381-392	Tuner Warwick Scissors (CRV)	-	17.8
381-394	Tuner Warwick Scissors (STR)	-	23.0
381-396	Tuner Warwick Scissors (CRV)	-	23.0
381-398	Dressing Scissors (STR)	-	17.8
381-400	Dressing Scissors (CRV)	-	17.8
381-402	Dressing Scissors (STR)	-	23.0
381-404	Dressing Scissors (CRV)	-	23.0
381-406	Wilson Hay Forceps (STR)	-	17.8
381-408	Wilson Hay Forceps (CRV)	-	17.8
381-410	Wilson Hay Forceps (STR)	-	23.0
381-412	Wilson Hay Forceps (CRV)	-	23.0
381-414	Artery Forceps (STR)	-	17.8
381-416	Artery Forceps (CRV)	-	17.8
381-418	Artery Forceps (STR)	-	23.0
381-420	Artery Forceps (CRV)	-	23.0
381-422	Abbey Needle	-	17.5
381-424	Richie Forceps	-	17.8
381-426	Richie Forceps	-	20.0
381-428	Richie Forceps	-	23.0

32



Adson
381-430



McINDOE
381-432



Gillies
381-434



Dissecting
381-442



Gerald
381-450



Adson Bayonet
381-452



Adson Bayonet UP
381-456



Remington Hobb
381-462

ENGLISH MONOPOLAR MALE 4.8MM CONNECTOR

Ref	Item Name	Tip Size	Length Size
381-430	Adson	1.0	12.0
381-432	McINDOE	1.0, 2.0	15.0
381-434	Gillies	-	15.0
381-436	Gillies	-	17.8
381-438	Gillies	-	20.0
381-440	Gillies	-	24.0
381-442	Dissecting	1.0, 2.0	15.0
381-444	Dissecting	1.0, 2.0	17.8
381-446	Dissecting	1.0, 2.0	21.0
381-448	Dissecting	1.0, 2.0	24.1
381-450	Gerald 1x2	-	17.8
381-452	Adson Bayonet	1.0, 2.0	16.0
381-454	Adson Bayonet	1.0, 2.0	19.1
381-456	Adson Bayonet Angled UP	1.0, 2.0	16.0
381-458	Adson Bayonet Angled UP	1.0, 2.0	19.1
381-460	Adson Bayonet Angled UP	1.0, 2.0	21.0
381-462	Remington Hobb	1.0, 2.0	24.1

EUROPEAN MONOPOLAR FEMALE 4.0MM CONNECTOR

Ref	Item Name	Tip Size	Length Size
381-364	Adson	1.0	12.0
381-366	McINDOE	1.0, 2.0	15.0
381-368	Gillies	-	15.0
381-370	Gillies	-	17.8
381-372	Gillies	-	20.0
381-474	Gillies	-	24.0
381-476	Dissecting	1.0, 2.0	15.0
381-478	Dissecting	1.0, 2.0	17.8
381-480	Dissecting	1.0, 2.0	21.0
381-482	Dissecting	1.0, 2.0	24.1
381-484	Gerald 1x2	-	17.8
381-486	Adson Bayonet	1.0, 2.0	16.0
381-488	Adson Bayonet	1.0, 2.0	19.1
381-490	Adson Bayonet Angled UP	1.0, 2.0	16.0
381-492	Adson Bayonet Angled UP	1.0, 2.0	19.1
381-494	Adson Bayonet Angled UP	1.0, 2.0	21.0
381-496	Remington Hobb	1.0, 2.0	24.1

ENGLISH MONOPOLAR MALE 4.0MM CONNECTOR

Ref	Item Name	Tip Size	Length Size
381-498	Adson	1.0	12.0
381-500	McINDOE	1.0, 2.0	15.0
381-502	Gillies	-	15.0
381-504	Gillies	-	17.8
381-506	Gillies	-	20.0
381-508	Gillies	-	24.0
381-510	Dissecting	1.0, 2.0	15.0
381-512	Dissecting	1.0, 2.0	17.8
381-514	Dissecting	1.0, 2.0	21.0
381-516	Dissecting	1.0, 2.0	24.1
381-518	Gerald 1x2	-	17.8
381-520	Adson Bayonet	1.0, 2.0	16.0
381-522	Adson Bayonet	1.0, 2.0	19.1
381-524	Adson Bayonet Angled UP	1.0, 2.0	16.0
381-526	Adson Bayonet Angled UP	1.0, 2.0	19.1
381-528	Adson Bayonet Angled UP	1.0, 2.0	21.0
381-530	Remington Hobb	1.0, 2.0	24.1

MONOPOLAR WITHOUT CONNECTOR

Ref	Item Name	Tip Size	Length Size
381-532	Adson	1.0	12.0
381-534	McINDOE	1.0, 2.0	15.0
381-536	Gillies	-	15.0
381-538	Gillies	-	17.8
381-540	Gillies	-	20.0
381-542	Gillies	-	24.0
381-544	Dissecting	1.0, 2.0	15.0
381-546	Dissecting	1.0, 2.0	17.8
381-548	Dissecting	1.0, 2.0	21.0
381-550	Dissecting	1.0, 2.0	24.1
381-552	Gerald 1x2	-	17.8
381-554	Adson Bayonet	1.0, 2.0	16.0
381-556	Adson Bayonet	1.0, 2.0	19.1
381-558	Adson Bayonet Angled UP	1.0, 2.0	16.0
381-560	Adson Bayonet Angled UP	1.0, 2.0	19.1
381-562	Adson Bayonet Angled UP	1.0, 2.0	21.0
381-564	Remington Hobb	1.0, 2.0	24.1



NAWROOZ disposable bipolar forceps have been designed and tested to meet the practical. The main purpose for offering single-use bipolar forceps is to avoid the risk of contamination while remaining cost effective and utilizing the functionalities of the higher end forceps. Hardened stainless steel provides an optimum spring tension and serves as the basis for a superior instrument

Advantages of Disposable Bipolar Forceps

- *Lightweight and well balanced to prevent fatigue.*
- *Highly polished tips minimise sticking.*
- *Nylon coating resists abrasion and provides superb insulation.*
- *Precision tip alignment aids fine control.*
- *Cost effective in comparison to re-usable.*
- *All Bipolar forceps available with cable, sterile packed.*
- *Compatible with all common electrosurgery unit.*

34



381-570-DP

Jeweller #5



381-572-DP

Straight



381-574-DP

Bayonet



381-576-DP

Straight



381-578-DP

Straight Angled

Tip Chart

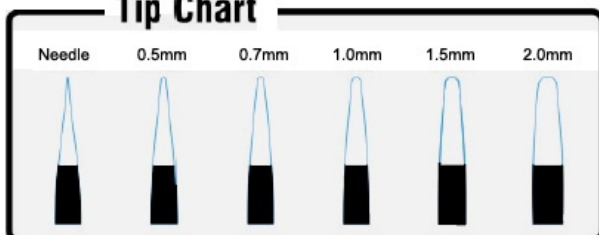

Tip size can be changed as per your requirement, just add the following extensions
fit tip size at the end of Ref #: **TIP**- Needle, 05, 0.7mm, 1.0mm, 1.5mm & 2.0mm

Ref	Item Name	Tip Size (mm)	Length Size (cm)
381-570-DP	Jeweller #5 With 3m Cable	0.5	11.5
381-572-DP	Straight With 3m Cable	1.0, 1.5	18.0
381-574-DP	Bayonet With 3m Cable	1.0, 1.5	18.0
381-576-DP	Straight	1.0, 1.5	18.0
381-578-DP	Bayonet	1.0, 1.5	20.0

Note: More Disposable Bipolar Forceps are Available Use DP extension to any regular Bipolar Forceps.

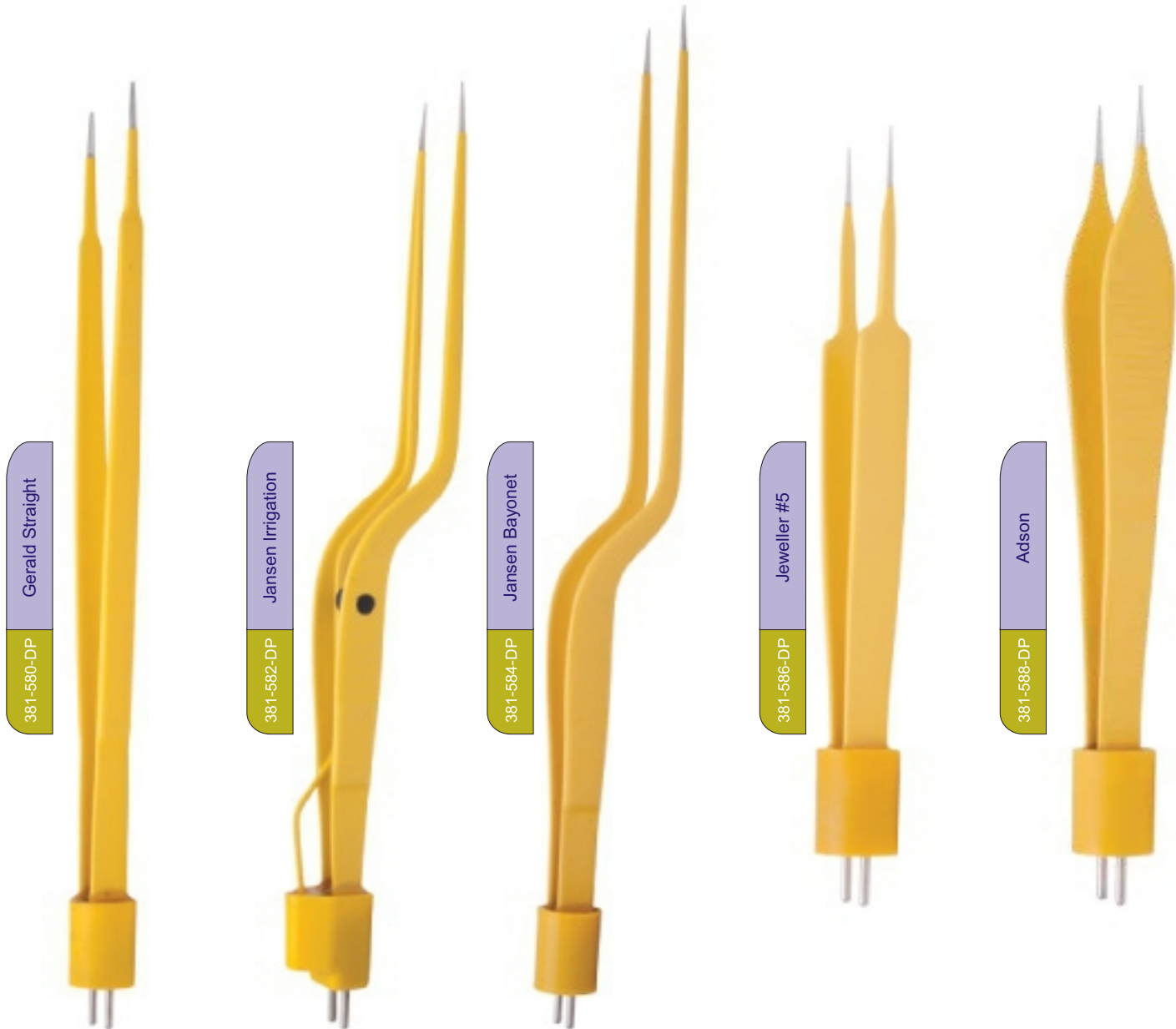

Gerald Straight
381-580-DP

Jansen Irrigation
381-582-DP

Jansen Bayonet
381-584-DP

Jeweller #5
381-586-DP

Adson
381-588-DP

Tip Chart

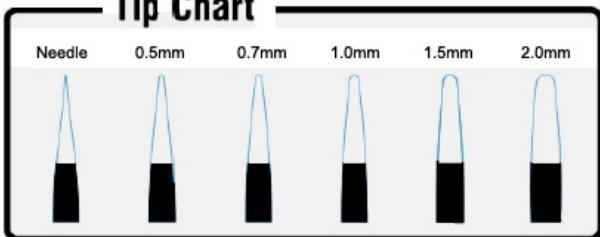

Tip size can be changed as per your requirement, just add the following extensions fit tip size at the end of Ref #: TIP- Needle, 0.5, 0.7mm, 1.0mm, 1.5mm & 2.0mm

Ref	Item Name	Tip Size (mm)	Length Size (cm)
381-580-DP	US. Gerald	1.0, 1.5	17.8
381-582-DP	US. Jansen Bayonet Irrigation	1.0, 1.5	19.1
381-584-DP	US. Jansen Bayonet	1.0, 1.5	17.8
381-586-DP	US. Jeweller #5	0.5	11.5
381-588-DP	US. Adson	1.0	12.1

Note: More Disposable Bipolar Forceps are Available Use DP extension to any regular Bipolar Forceps.



The First Choice For Proven Performance, NAWROOZ Provides The Broadest selection of fully autoclavable instruments for LEEP procedures. Our "rose coated" instruments will provide you with durability and performance unmatched in the industry. Models Available: Graves, Pederson, VU-More, 4-Way, Cusco, Collin, Weisman, Gelpi, Rigby, Lateral, Lateral Vaginal, .Endocervical, Iris, Emmet, Straight, two-prong, three-prong, etc

37



Disposable Tube



Graves Vaginal Speculum
With Smoke Evacuation Tube
Small **381-600**
Medium **381-602**
Large **381-604**

Small **381-606**
Medium **381-608**
Large **381-610**



Disposable Tube



Pederson Vaginal Speculum
With Smoke Evacuation Tube
Small **381-612**
Medium **381-614**
Large **381-616**

Small **381-618**
Medium **381-620**
Large **381-622**



Disposable Tube



VU-Max Graves Vaginal Speculum
With Smoke Evacuation Tube
Medium **381-624**
Large **381-626**

Medium **381-628**
Large **381-630**



Disposable Tube



VU-Max Pederson Vaginal Speculum
With Smoke Evacuation Tube
Medium **381-632**
Large **381-634**

Medium **381-636**
Large **381-638**



Collin Vaginal Speculum
With Smoke Evacuation Tube
Small **381-640**
Medium **381-642**
Large **381-644**



CUSCO Vaginal Speculum
With Smoke Evacuation Tube
Small **381-646**
Medium **381-648**
Large **381-650**

38



Disposable Tube



VU-More Graves Vaginal Speculum *With Smoke Evacuation Tube*
Medium **381-656**
Large **381-658**



4-Blades Speculum *With Smoke Evacuation Tube*
Medium **381-660**
Large **381-662**



Disposable Tube



Weisman Vaginal Speculum
Right Side Open *With Smoke Evacuation Tube*
Medium **381-664**
Large **381-666**



Disposable Tube



Weisman Vaginal Speculum
Left Side Open *With Smoke Evacuation Tube*
Medium **381-672**
Large **381-674**

Medium **381-676**
Large **381-678**



Lateral Retractor
Wide Open
381-680



Rigby Retractor
Wide Open
381-682



Gelpi Retractor
Wide Open
381-684



Kogan Speculum
3mm **381-686**
4mm **381-688**
5mm **381-690**



Lateral Retractor
21cm 22mmx75mm
381-692

39



**Schroeder
Tanaculum 24cm**
381-694



**Schroeder
Tanaculum 24cm**
381-696



**Single Tooth
Tanaculum 24cm**
381-698



**Campion
Forceps 22cm**
381-700



**Spong
Forceps 22cm**
381-702

Dressing Forceps
381-704 21cm
381-706 25cm



Tissue Forceps
381-708 21cm
381-710 25cm



Iris Hook
381-712 25cm



Emmet Hook
381-714 25cm



Emmet Hook Straight
381-716 25cm



Emmet Hook Two Prong
381-718 25cm



Emmet Hook Three Prong
381-720 25cm





Through a non-reflective coating technique the glare produced during laser surgery is significantly minimized. The stainless steel surface is specially prepared keeping in mind the superior coating requirements for our range of laser surgery instruments. Custom sizes and shapes are available as well as partial gold plating services for certain instruments as per customer requirements. Models Available: Graves, Pederson, VU-More, 4-Way, Cusco, Collin, Weisman, Gelpi, Rigby, Lateral, Lateral Vaginal, Endocervical, Iris, Emmet, Straight, two-prong, three-prong, etc.



Graves Vaginal Speculum

With Smoke Evacuation Tube

Small **381-750**

Medium **381-752**

Large **381-754**



Pederson Vaginal Speculum

With Smoke Evacuation Tube

Small **381-756**

Medium **381-758**

Large **381-760**



Collin Vaginal Speculum

With Smoke Evacuation Tube

Small **381-762**

Medium **381-764**

Large **381-766**



Lateral Vaginal Speculum

381-766

Kogan Endocervical Speculum



3mm **381-770**



4mm **381-772**



5mm **381-774**

42



Rigby Retractor
381-778



Gelpi Retractor
381-776



Schroeder Tenaculum
381-780



Iris Hook
381-782



Emmet Hook
381-784



Emmet Hook Straight
381-786



Emmet Hook Two Prong
381-788



Emmet Hook Three Prong
381-790



These E-Z Clean Laparoscopic Electrodes are made from very high quality raw material which ensures hassle free work performance at its user end. These E-Z Clean Laparoscopic Electrodes are widely finds its applications in various medical sectors.

Salient Features of our E-Z Clean Laparoscopic Electrodes

- *Provide excellent dissection and coagulation for a variety of surgical applications.*
- *High-tech PTFE coating for reduced eschar buildup.*
- *Reintroduction during surgery is minimized.*
- *Lower power settings for safer delivery of electrosurgery.*
- *Tips are cost-effective because they Save Time and Money.*

44

Without Suction



L-Hook Electrode 36cm
381-800



J-Hook Electrode 36cm
381-802



Needle Electrode 36cm
381-804



Spectula Electrode 36cm
381-806



Ball Electrode 36cm
381-808



With Suction



L-Hook Electrode 36cm
381-810



J-Hook Electrode 36cm
381-812



Needle Electrode 36cm
381-814



Spectula Electrode 36cm
381-816

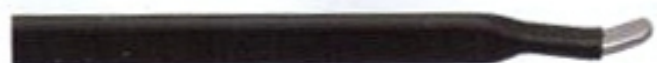

Ball Electrode 36cm
381-818

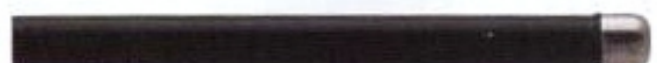

45

Dagger 12xm
381-820



Dagger 18cm
381-822



Hook 12cm
381-824



Hook 18cm
381-826



Hockey 12cm
381-828



Hockey 18cm
381-830



Frazier Suction Tube 11FR 13.5cm
381-832



Frazier Suction Tube 11FR 20.5cm
381-834



Frazier Suction Tube 11FR 40.6cm
381-836





Electro handle with blade electrode for single-use. Sterile packaging in individual pouches. Ready to use. This handle is made of high quality material and fits into the surgeon's hand comfortably due to its ergonomic shape. The quality meets highest expectations and fulfills all required international safety regulations.

- *Single-use electrode handle including blade electrode and 3 m cable (also available: 5 m)*
- *Individually packaged, sterile.*
- *Push buttons for cutting and coagulation.*
- *Unit side: 3-pin connector.*
- *Tips are cost-effective because they Save Time and Money.*
- *Suitable also for use with ERBE, Martin or Berchtold units, by addition of an adapter especially designed for such purpose.*

47



Rocker Switch Pencil (Single Use)
3m Cable 381-854



Foot Control Pencil (Single Use)
3m Cable 381-856
5m Cable 381-858



Finger Switch Pencil (Reusable)
3m Silicon Cable 381-860



Electrode Handle (Reusable)
3m Silicon Cable 381-862



Finger Switch Pencil (Single Use)
3m Cable 381-850
5m Cable 381-852

48



Blade Electrode
Disposable: 381-900-S Reusable: 381-900-R



Blade Electrode Crv
Disposable: 381-902-S Reusable: 381-902-R



Needle Electrode
Disposable: 381-904-S Reusable: 381-904-R



Needle Electrode Crv
Disposable: 381-906-S Reusable: 381-906-R



Ball Electrode 2mm
Disposable: 381-908-S Reusable: 381-908-R



Ball Electrode Crv 2mm
Disposable: 381-910-S Reusable: 381-910-R



Ball Electrode 3mm
Disposable: 381-912-S Reusable: 381-912-R



Ball Electrode 3mm Crv
Disposable: 381-914-S Reusable: 381-914-R



Ball Electrode 4mm
Disposable: 381-916-S Reusable: 381-916-R



Ball Electrode 4mm Crv
Disposable: 381-918-S Reusable: 381-918-R



Ball Electrode 5mm
Disposable: 381-920-S Reusable: 381-920-R



Ball Electrode 5mm Crv
Disposable: 381-922-S Reusable: 381-922-R



Blade Electrode Shaft 13cm
Disposable: 381-924-S Reusable: 381-924-R



Needle Electrode Shaft 13cm
Disposable: 381-926-S Reusable: 381-926-R



Ball Electrode 3mm Shaft 13cm
Disposable: 381-928-S Reusable: 381-928-R



Ball Electrode 5mm Shaft 13cm
Disposable: 381-930-S Reusable: 381-930-R



Conization Electrode
Disposable: 381-932-S Reusable: 381-932-R



Circle Loop Electrode 4mm
Disposable: 381-934-S Reusable: 381-934-R



Circle Loop Electrode 6mm
Disposable: 381-936-S Reusable: 381-936-R



Circle Loop Electrode 8mm
Disposable: 381-938-S Reusable: 381-938-R







Diamond Electrode
Disposable: 381-940-S Reusable: 381-940-R







Fine Needle Electrode
Disposable: 381-942-S Reusable: 381-942-R



					
Size	1.0x0.4cm	1.0x0.5cm	1.0x0.7cm	1.0x0.8cm	1.0x1.0cm
Disposable	381-944-S	381-946-S	381-948-S	381-950-S	381-952-S
Reusable	381-944-R	381-946-R	381-948-R	381-950-R	381-952-R





					
Size	1.0x0.5cm	1.0x0.7cm	1.0x0.8cm	1.0x1.0cm	1.0x1.5cm
Disposable	381-954-S	381-956-S	381-958-S	381-960-S	381-962-S
Reusable	381-954-R	381-956-R	381-958-R	381-960-R	381-962-R



						
Size	1.5x0.5cm	1.5x0.7cm	1.5x0.8cm	1.5x1.0cm	1.5x1.2cm	1.5x1.5cm
Disposable	381-964-S	381-966-S	381-968-S	381-970-S	381-972-S	381-974-S
Reusable	381-964-R	381-966-R	381-968-R	381-970-R	381-972-R	381-974-R



						
Size	2.0x0.8cm	2.0x1.0cm	2.0x1.2cm	2.0x1.3cm	2.0x1.5cm	2.0x2.0cm
Disposable	381-976-S	381-978-S	381-980-S	381-982-S	381-984-S	381-986-S
Reusable	381-976-R	381-978-R	381-980-R	381-982-R	381-984-R	381-986-R



Blade Electrode
Disposable: 381-1000-S Reusable: 381-1000-R



Blade Electrode Crv
Disposable: 381-1002-S Reusable: 381-1002-R



Needle Electrode
Disposable: 381-1004-S Reusable: 381-1004-R



Needle Electrode Crv
Disposable: 381-1006-S Reusable: 381-1006-R



Ball Electrode 2mm
Disposable: 381-1008-S Reusable: 381-1008-R



Ball Electrode Crv 2mm
Disposable: 381-1010-S Reusable: 381-1010-R



Ball Electrode 3mm
Disposable: 381-1012-S Reusable: 381-1012-R



Ball Electrode 3mm Crv
Disposable: 381-1014-S Reusable: 381-1014-R



Ball Electrode 4mm
Disposable: 381-1016-S Reusable: 381-1016-R



Ball Electrode 4mm Crv
Disposable: 381-1018-S Reusable: 381-1018-R



Ball Electrode 5mm
Disposable: 381-1020-S Reusable: 381-1020-R



Ball Electrode 5mm Crv
Disposable: 381-1022-S Reusable: 381-1022-R



Blade Electrode Shaft 13cm
Disposable: 381-1024-S Reusable: 381-1024-R



Needle Electrode Shaft 13cm
Disposable: 381-1026-S Reusable: 381-1026-R



Ball Electrode Shaft 3mm 13cm
Disposable: 381-1028-S Reusable: 381-1028-R



Ball Electrode 4mm Shaft 13cm
Disposable: 381-1030-S Reusable: 381-1030-R



Ball Electrode 5mm 13cm
Disposable: 381-1032-S Reusable: 381-1032-R



Circle Loop Electrode 4mm 0.7cm
Disposable: 381-1034-S Reusable: 381-1034-R



Circle Loop Electrode 6mm 0.7cm
Disposable: 381-936-S Reusable: 381-936-R



Circle Loop Electrode 8mm 0.7cm
Disposable: 381-1038-S Reusable: 381-1038-R



Circle Loop Electrode 10mm 0.7cm
Disposable: 381-940-S Reusable: 381-940-R







Plate Electrode Small
Disposable: 381-1042-S Reusable: 381-1042-R







Plate Electrode Large
Disposable: 381-1044-S Reusable: 381-1044-R









					
Size	1.0x0.4cm	1.0x0.5cm	1.0x0.7cm	1.0x0.8cm	1.0x1.0cm
Disposable	381-1046-S	381-1048-S	381-1050-S	381-1052-S	381-1054-S
Reusable	381-1046-R	381-1048-R	381-1050-R	381-1052-R	381-1054-R









					
Size	1.0x0.5cm	1.0x0.7cm	1.0x0.8cm	1.0x1.0cm	1.0x1.5cm
Disposable	381-1056-S	381-1058-S	381-1060-S	381-1062-S	381-1064-S
Reusable	381-1056-R	381-1058-R	381-1060-R	381-1062-R	381-1064-R



						
Size	1.5x0.5cm	1.5x0.7cm	1.5x0.8cm	1.5x1.0cm	1.5x1.2cm	1.5x1.5cm
Disposable	381-1066-S	381-1068-S	381-1070-S	381-1072-S	381-1074-S	381-1076-S
Reusable	381-1066-R	381-1068-R	381-1070-R	381-1072-R	381-1074-R	381-1076-R



						
Size	2.0x0.8cm	2.0x1.0cm	2.0x1.2cm	2.0x1.3cm	2.0x1.5cm	2.0x2.0cm
Disposable	381-1078-S	381-1080-S	381-1082-S	381-1084-S	381-1086-S	381-1088-S
Reusable	381-1078-R	381-1080-R	381-1082-R	381-1084-R	381-1086-R	381-1088-R



NAWROOZ SURGICAL Cables are available in disposable and reusable grade. We offer high quality silicon cables even for our single-use instruments thus making sure that all cables are able to withstand electrical current above the standard requirements. Furthermore, numerous tests including continuity and leak test ensures that our cables will work under the toughest requirements. Multiples sizes and plugs are

available as per the need of the customer. Our cables are durable, flexible and able to withstand sterilization processes if needed. By following international standards we ensure that our cables are compatible with most major ESU's. Our cables are available in lengths 3 m, 4 m or 5 m.

53



Bipolar Cable

Instruments Connector: **USA 2-Pin Plug**
Generator Connector: **4mm Banana Plug**
Reusable Silicon 3m Cable **381-1100**
Single Use 3m Cable **381-1102**



Bipolar Cable

Instruments Connector: **European Flat Plug**
Generator Connector: **4mm Banana Plug**
Reusable Silicon 3m Cable **381-1104**
Single Use 3m Cable **381-1106**

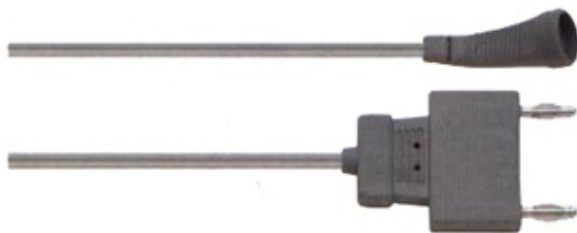

Bipolar Cable

Instruments Connector: **USA 2-Pin Plug**
Generator Connector: **Pin Distance 29mm**
Reusable Silicon 3m Cable **381-1112**
Single Use 3m Cable **381-1114**

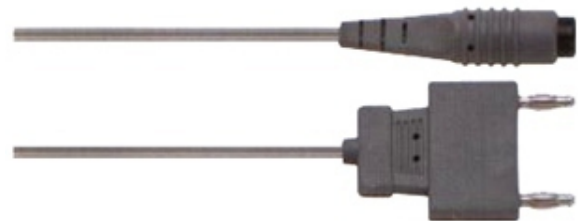

Bipolar Cable

Instruments Connector: **European Flat Plug**
Generator Connector: **Pin Distance 29mm**
Reusable Silicon 3m Cable **381-1108**
Single Use 3m Cable **381-1110**



Bipolar Cable

Instruments Connector: **Bipolar Artery Sealer**
Generator Connector: **4mm Banana Plug**
Reusable Silicon 3m Cable **381-1116**



European Bipolar Cable

Instruments Connector: **European Flat Plug**

Generator Connector: **Martin Type**

Reusable Silicon 3m Cable **381-1118**



US Bipolar Cable

Instruments Connector: **USA 2-Pin Plug**

Generator Connector: **Martin Type**

Reusable Silicon 3m Cable **381-1120**



European Bipolar Cable

Instruments Connector: **European Flat Plug**

Generator Connector: **Erbe Type**

Reusable Silicon 3m Cable **381-1122**



US Bipolar Cable

Instruments Connector: **USA 2-Pin Plug**

Generator Connector: **Erbe Type**

Reusable Silicon 3m Cable **381-1124**



Bipolar Cable

Instruments Connector: **Ethicon**

Generator Connector: **4mm Banana Plug**

Reusable Silicon 3m Cable **381-1126**

55



Monopolar Cable

Instruments Connector: **Screw Type**

Generator Connector: **Standard Bovie 8mm Plug**

Reusable Silicon 3m Cable **381-1128**

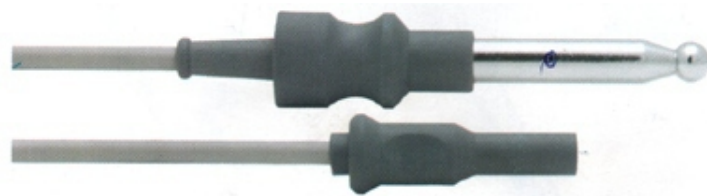

Monopolar Cable

Instruments Connector: **4mm Female Fitting**

Generator Connector: **Standard Bovie 8mm Plug**

Reusable Silicon 3m Cable **381-1130**



Monopolar Endoscopic Cable

Instruments Connector: **4mm Female Fitting**

Generator Connector: **4mm Banana Plug**

Reusable Silicon 3m Cable **381-1132**



Diathermy Cable

Instruments Connector: **4mm Male Fitting**

Generator Connector: **4mm Banana Plug**

Reusable Silicon 3m Cable **381-1134**



Diathermy Cable

Instruments Connector: **4.8mm Female Fitting**

Generator Connector: **4mm Banana Plug**

Reusable Silicon 3m Cable **381-1136**



Diathermy Cable

Instruments Connector: **4.8mm Female Fitting**

Generator Connector: **Stan. Bovie 8mm Plug**

Reusable Silicon 3m Cable **381-1138**

56

- 381-1150** Artery Sealer 6.5"
- 381-1152** Artery Sealer 7.5"
- 381-1154** Artery Sealer 8.5"
- 381-1156** Artery Sealer 9.5"
- 381-1158** Artery Sealer 10.5"



- 381-1160** Non-Stick Artery Sealer 6.5"
- 381-1162** Non-Stick Artery Sealer 7.5"
- 381-1164** Non-Stick Artery Sealer 8.5"
- 381-1166** Non-Stick Artery Sealer 9.5"
- 381-1168** Non-Stick Artery Sealer 10.5"



ELECTRO SURGICAL



NAWROOZ SURGICAL

TEL: +92-313-7879420

Email: nawroozsurgical72@gmail.com

SIALKOT 51310 | PAKISTAN