



# General Surgery Instruments



**NAWROOZ  
SURGICAL**  
Quality Makes Innovation



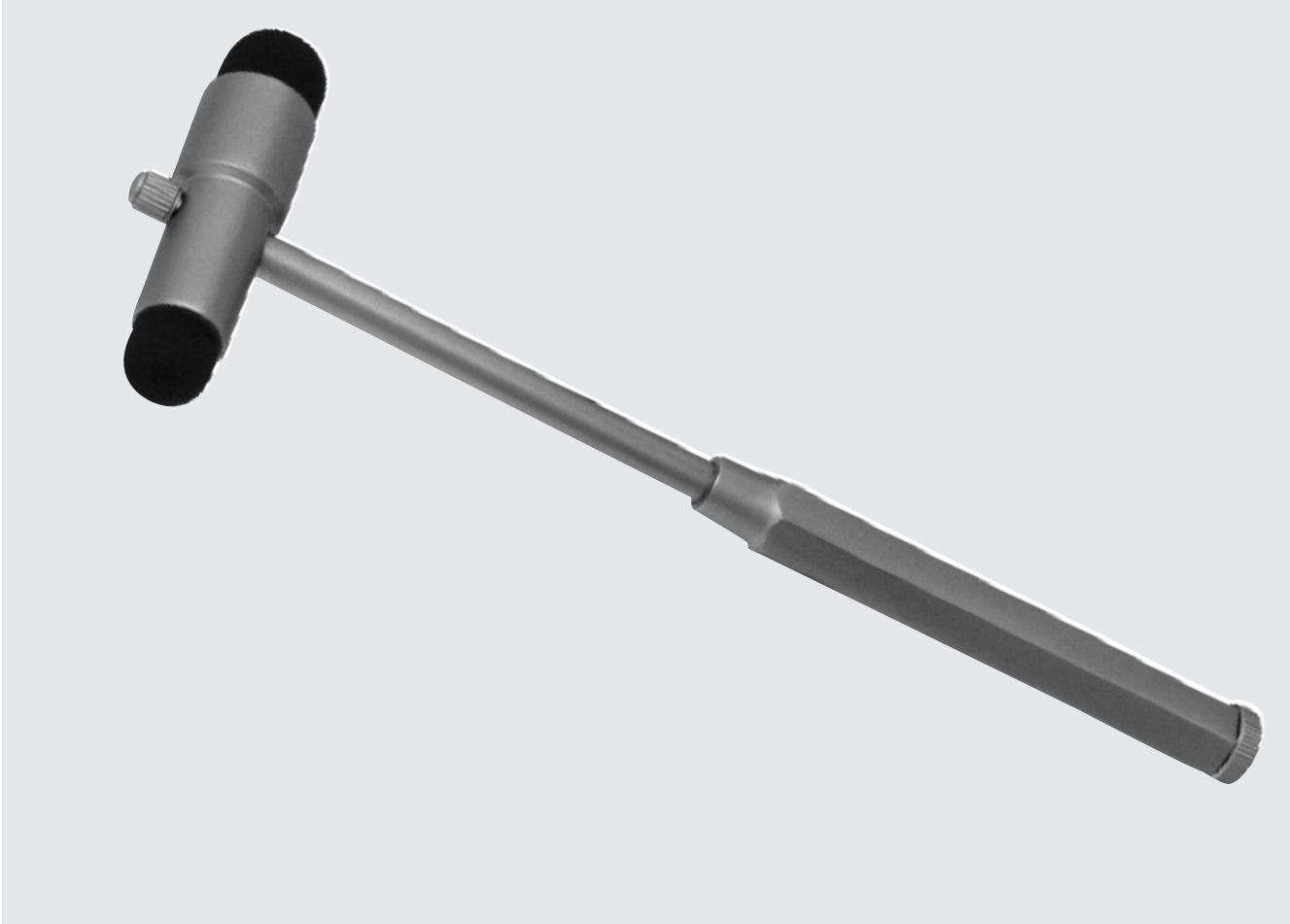

# Diagnostic Instruments



NF.01.01.08  
Needle Only

NF.01.01.09  
Brush Only



BUCK  
NF.01.01.18  
18 cm / 7 1/8"



Reversible Head

BABINSKI  
NF.01.04.22  
22 cm / 8 3/4"  
with needle

NF.01.05.22  
22 cm / 8 3/4"  
without needle

NF.01.04.27  
26 cm / 10 1/4"  
with needle

NF.01.05.26  
26 cm / 10 1/4"



NF.01.04.08  
Needle Only



NF.01.06.08  
Needle Only



DEJERINE  
NF.01.06.21  
21 cm / 8 1/4"

Flat Pointed  
Handle

DEJERINE  
NF.01.07.20  
20 cm / 8"



DEJERINE  
NF.01.08.20  
20 cm / 8"



TROEMNER  
NF.01.10.08  
23 cm / 9"

NF.01.10.10  
25 cm / 10"



BERLINER  
NF.01.11.10  
20 cm / 8"



TAYLOR  
NF.01.12.50  
20 cm / 8"

**Diagnostic Instruments**



PINARD  
NF.01.14.10  
15 cm/ 6"



WARTENBERG  
NF.01.19.25  
18 cm/ 7 1/8"



Nawrooz  
NF.01.19.55  
19 cm/ 7 1/2"

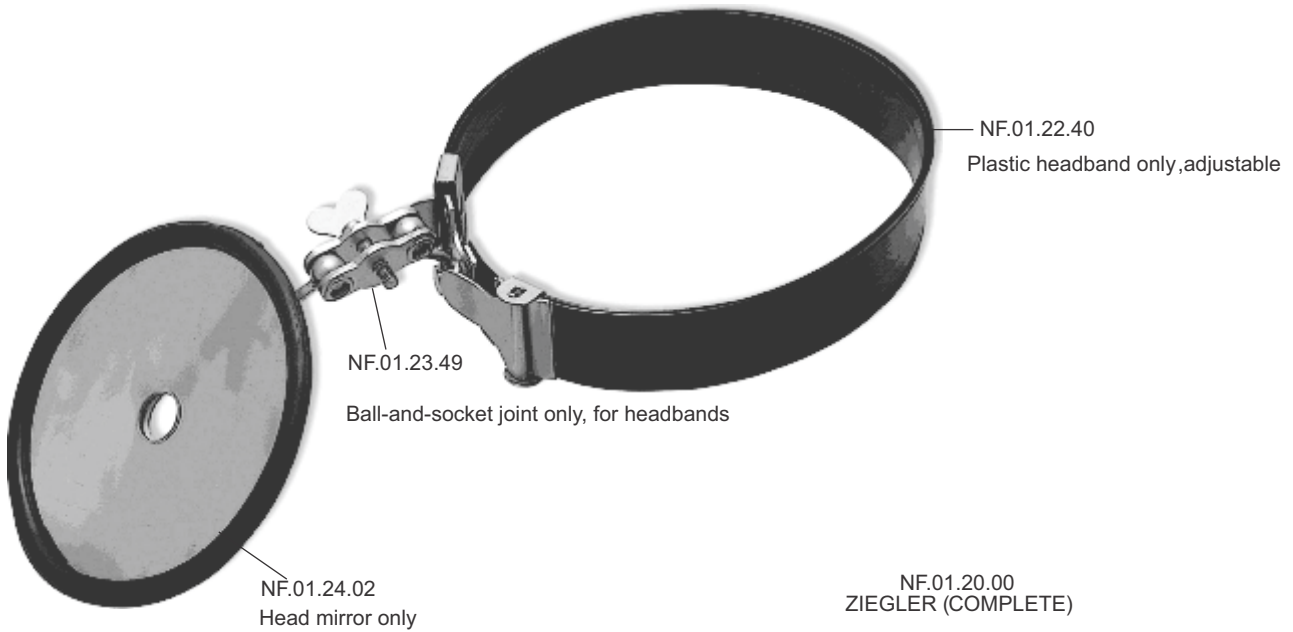

NF.01.24.02  
Head mirror only

NF.01.23.49  
Ball-and-socket joint only, for headbands

NF.01.22.40  
Plastic headband only, adjustable

NF.01.20.00  
ZIEGLER (COMPLETE)

# Diagnostic Instruments



JAMESON

NF.01.38.40  
10 cm / 4"  
Caliper, graduated in mm and inches



THORPE

NF.01.38.41  
11 cm / 4 1/4"  
graduated in mm and inches



NF.01.38.30  
13 cm / 5 1/8"  
Finger goniometer

graduated in cm and inches



NF.01.37.15 15 cm / 6"  
NF.01.37.20 20 cm / 8"  
NF.01.37.30 30 cm / 11 3/4"  
NF.01.37.50 50 cm / 19 3/4"  
Rules, Stainless Steel

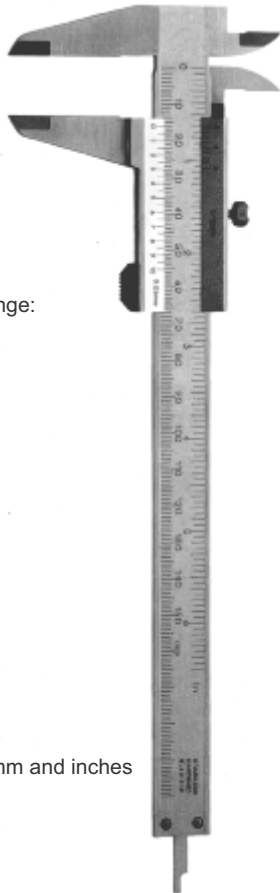

Measuring Range:  
Messbereich:

graduated in mm and inches

NF.01.38.05  
22 cm / 8 3/4"

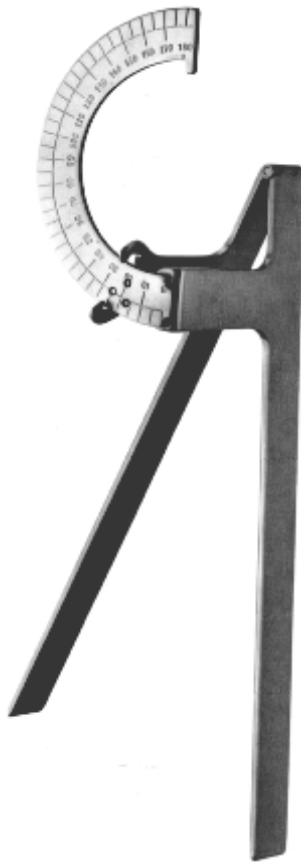

fold up  
zusammenlegbar  
plegable  
pliable  
pieghevole

Flexometer

MÖLTGEN  
NF.01.38.10  
24 cm / 9 1/2"

# Probes, Cotton Carries, Suction Instruments

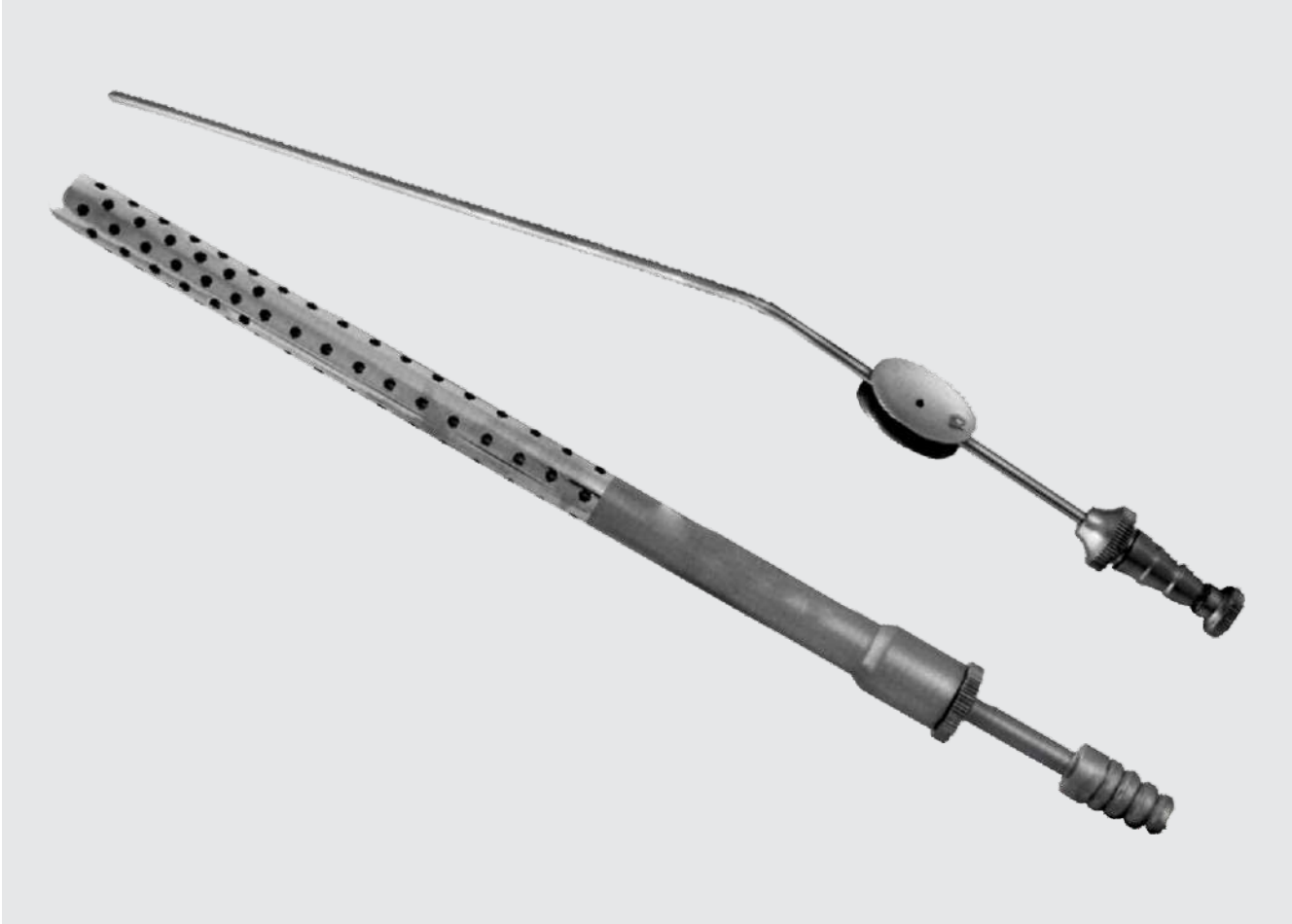

# Probes, Cotton Carries, Suction Instruments

Ø 1.0 mm



Ø 1.5 mm



stainless steel

Ø 2 mm



stainless steel



with eye

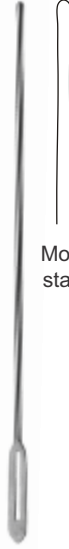

Mod USA  
stainless steel

Ø 3 mm

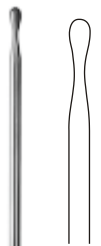

NF.01.11.14  
14.5 cm / 5¾"

NF.01.01.10 10.5 cm / 4⅛"  
NF.01.01.11 11.5 cm / 4½"  
NF.01.01.13 13 cm / 5⅝"  
NF.01.01.14 14.5 cm / 5¾"  
NF.01.01.16 16 cm / 6¼"  
NF.01.01.18 18 cm / 7⅞"  
NF.01.01.20 20 cm / 8"  
NF.01.01.25 25 cm / 10"

NF.01.02.10 10.5 cm / 4⅛"  
NF.01.02.11 11.5 cm / 4½"  
NF.01.02.13 13 cm / 5⅝"  
NF.01.02.14 14.5 cm / 5¾"  
NF.01.02.16 16 cm / 6¼"  
NF.01.02.18 18 cm / 7⅞"  
NF.01.02.20 20 cm / 8"  
NF.01.02.25 25 cm / 10"  
NF.01.02.30 30 cm / 11¾"

NF.01.04.13 13 cm / 5⅝"  
NF.01.04.14 14.5 cm / 5¾"  
NF.01.04.16 16 cm / 6¼"  
NF.01.04.20 20 cm / 8"

NF.01.05.13 13 cm / 5⅝"  
NF.01.05.14 14.5 cm / 5¾"  
NF.01.05.15 15 cm / 6"  
NF.01.05.16 16 cm / 6¼"  
NF.01.05.18 18 cm / 7⅞"  
NF.01.05.20 20 cm / 8"

NF.01.05.13 13 cm / 5⅝"  
NF.01.05.14 14.5 cm / 5¾"  
NF.01.05.15 15 cm / 6"  
NF.01.05.16 16 cm / 6¼"  
NF.01.05.18 18 cm / 7⅞"  
NF.01.05.20 20 cm / 8"

NF.01.05.13 13 cm / 5⅝"  
NF.01.05.14 14.5 cm / 5¾"  
NF.01.05.15 15 cm / 6"  
NF.01.05.16 16 cm / 6¼"  
NF.01.05.18 18 cm / 7⅞"  
NF.01.05.20 20 cm / 8"

NF.01.05.13 13 cm / 5⅝"  
NF.01.05.14 14.5 cm / 5¾"  
NF.01.05.15 15 cm / 6"  
NF.01.05.16 16 cm / 6¼"  
NF.01.05.18 18 cm / 7⅞"  
NF.01.05.20 20 cm / 8"

NF.01.05.13 13 cm / 5⅝"  
NF.01.05.14 14.5 cm / 5¾"  
NF.01.05.15 15 cm / 6"  
NF.01.05.16 16 cm / 6¼"  
NF.01.05.18 18 cm / 7⅞"  
NF.01.05.20 20 cm / 8"



with eye



malleable

stainless steel

NF.01.05.21  
20 cm / 8"

NF.01.07.11 11.5 cm / 4½"  
NF.01.07.13 13 cm / 5⅝"  
NF.01.07.14 14.5 cm / 5¾"  
NF.01.07.16 16 cm / 6¼"  
NF.01.07.18 18 cm / 7⅞"  
NF.01.07.20 20 cm / 8"

NF.01.08.84  
14 cm / 5½"

NF.01.09.13 13 cm / 5⅝"  
NF.01.09.14 14.5 cm / 5¾"

NELATON  
NF.01.10.66  
16 cm / 6¼"

NF.01.12.80  
30 cm / 11¾"

**Probes, Cotton Carries, Suction Instruments**

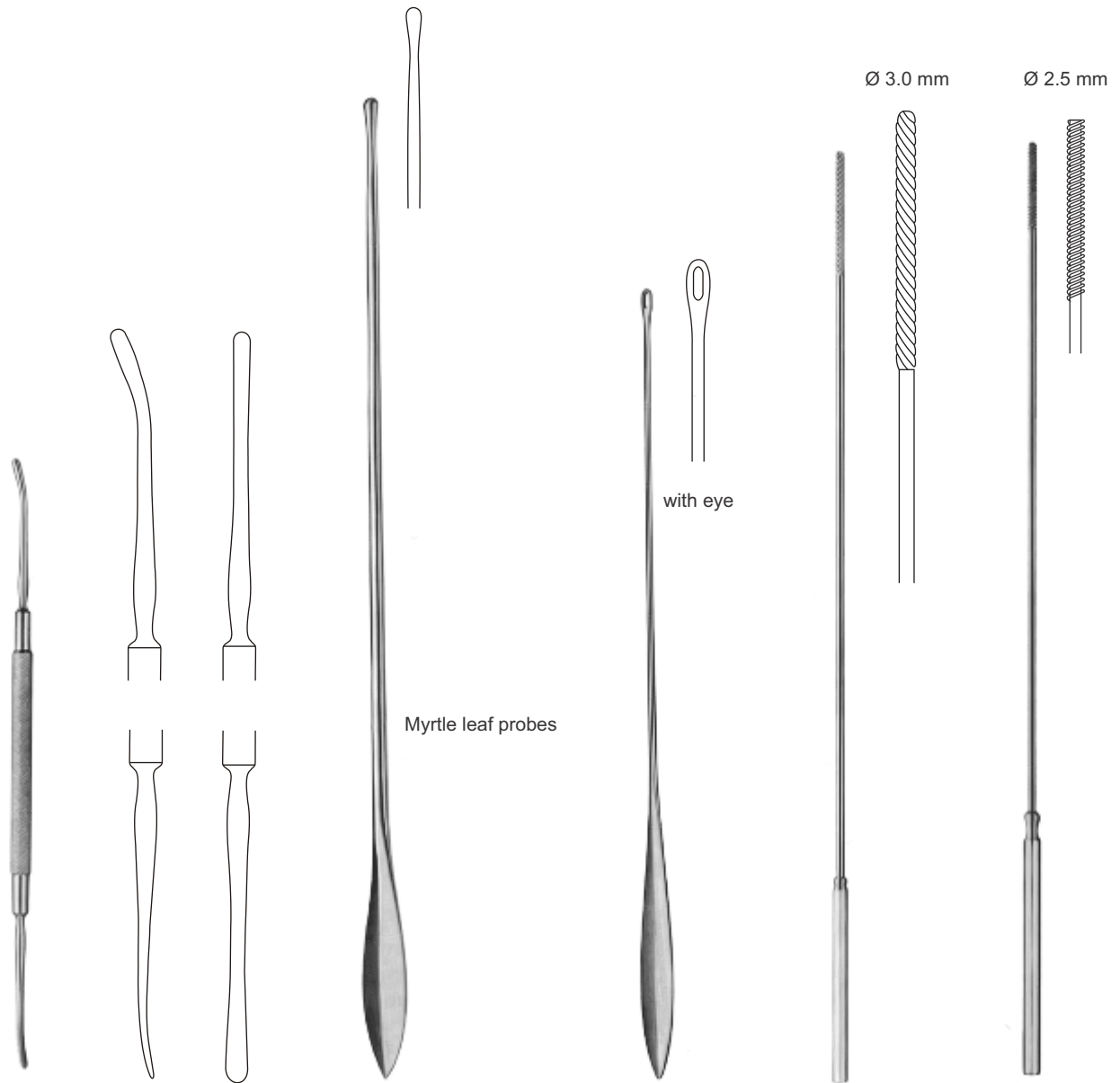

WATSON-CHEYNE  
NF.01.10.73 13 cm/ 5 $\frac{1}{8}$ "  
NF.01.10.78 18 cm/ 7 $\frac{1}{8}$ "

NF.01.13.13 13 cm/ 5 $\frac{1}{8}$ "  
NF.01.13.14 14.5 cm/ 5 $\frac{3}{4}$ "  
NF.01.13.16 16 cm/ 6 $\frac{1}{4}$ "  
NF.01.13.18 18 cm/ 7 $\frac{1}{8}$ "  
NF.01.13.20 20 cm/ 8"









NF.01.13.24  
24 cm/ 9 $\frac{1}{2}$ "

NF.01.12.28  
28 cm/ 11"

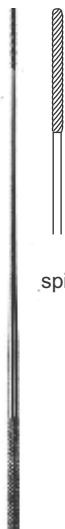
NF.01.13.48  
28 cm/ 11"

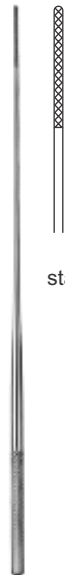

# Probes, Cotton Carries, Suction Instruments

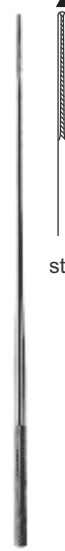
<p>Ø 1.3mm</p> 	<p>Ø 1.5mm</p> 	<p>Ø 1.0mm</p> <p>spiral threads</p> 	<p>Ø 1.0mm</p> 	<p>Ø 1.0mm</p> 
<p><b>UCKERMANN</b> NF.01.14.16 16 cm/ 6¼"</p>	<p><b>JOBSON-HORNE</b> NF.01.14.18 18 cm/ 7⅝"</p>	<p><b>FROHN</b> NF.01.16.12 12 cm/ 4¾" NF.01.16.14 14 cm/ 5½" NF.01.16.16 16 cm/ 6¼"</p>	<p><b>FROHN</b> NF.01.16.22 12 cm/ 4¾" NF.01.16.24 14 cm/ 5½" NF.01.16.26 16 cm/ 6¼"</p>	<p>NF.01.16.32 12 cm/ 4¾" NF.01.16.34 14 cm/ 5½" NF.01.16.36 16 cm/ 6¼"</p>
<p>Ø 1.5mm</p> 	<p>Ø 2.0 mm</p> 	<p>Ø 1.2mm</p> <p>stainless steel</p> 	<p>Ø 1.2mm</p> <p>stainless steel</p> 	<p>Ø 1.2mm</p> <p>stainless steel</p> 
<p><b>Nawrooz</b> NF.01.17.12 12 cm/ 4¾" NF.01.17.14 14.5 cm/ 5¾" NF.01.17.16 16 cm/ 6¼" NF.01.17.18 18 cm/ 7⅝"</p>	<p><b>ANDREWS</b> NF.01.18.15 15 cm/ 6" NF.01.18.18 18 cm/ 7⅝"</p>	<p><b>LATHBURY (FARRELL)</b> NF.01.19.12 12 cm/ 4¾" NF.01.19.14 14 cm/ 5½" NF.01.19.15 15 cm/ 6" NF.01.19.16 16 cm/ 6¼" NF.01.19.18 18 cm/ 7⅝"</p>	<p><b>LATHBURY (FARRELL)</b> NF.01.19.22 12 cm/ 4¾" NF.01.19.24 14 cm/ 5½" NF.01.19.25 15 cm/ 6" NF.01.19.26 16 cm/ 6¼" NF.01.19.28 18 cm/ 7⅝"</p>	<p>NF.01.19.32 12 cm/ 4¾" NF.01.19.34 14 cm/ 5½" NF.01.19.36 16 cm/ 6¼"</p>

# Probes, Cotton Carries, Suction Instruments



Plaster spatulas

NF.01.14.23 13 cm / 5 1/8"  
NF.01.14.24 14.5 cm / 5 3/4"

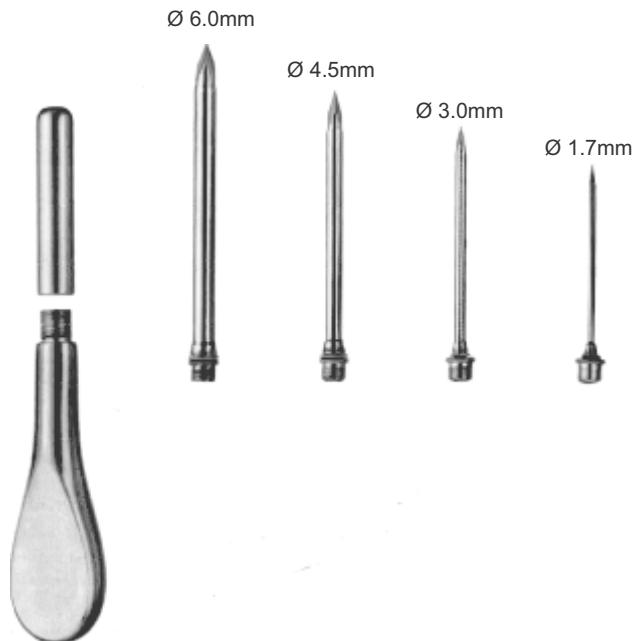

UNIVERSAL  
NF.01.21.04



Roberts

	Outer Ø		Inner Ø
	mm	Charr.	mm
NF.01.23.50	5.0	15	4.0
NF.01.23.55	5.5		4.5
NF.01.23.60	6.0	18	5.0
NF.01.23.65	6.5		5.5



NELSON

	Outer Ø		Inner Ø
	mm	charr.	mm
NF.01.24.09	3.0	9	2.2
NF.01.24.10	3.5		2.5
NF.01.24.12	4.0	12	3.0
NF.01.24.13	4.5		3.5
NF.01.24.15	5.0	15	4.0
NF.01.24.16	5.5		4.5
NF.01.24.18	6.0	18	5.0
NF.01.24.20	6.5		5.5
NF.01.24.25	8.3	25	7.3
NF.01.24.30	10.0	30	9.0
NF.01.24.35	11.7	35	10.7

# Probes, Cotton Carries, Suction Instruments



GRAEFE

	Outer Ø		Inner Ø
	mm	charr.	mm
NF.01.25.30	3.0	9	2.2
NF.01.25.40	4.0	12	3.0
NF.01.25.45	4.5		3.5
NF.01.25.50	5.0	15	4.0
NF.01.25.55	5.5		4.5
NF.01.25.60	6.0	18	5.0



OCHSNER

for catheters

	Charr.	
NF.01.26.10	10	6
NF.01.26.12	12	8
NF.01.26.14	14	10
NF.01.26.16	16	12
NF.01.26.18	18	14
NF.01.26.20	20	16
NF.01.26.22	22	18
NF.01.26.24	24	20
NF.01.26.26	26	22



14 cm / 5½"

LANDAU  
NF.01.27.02  
Ø 2 mm



Outer Ø  
8mm

Inner Ø  
7mm

10 cm - 4"

BUELAU  
NF.01.28.08  
24 cm / 9½"

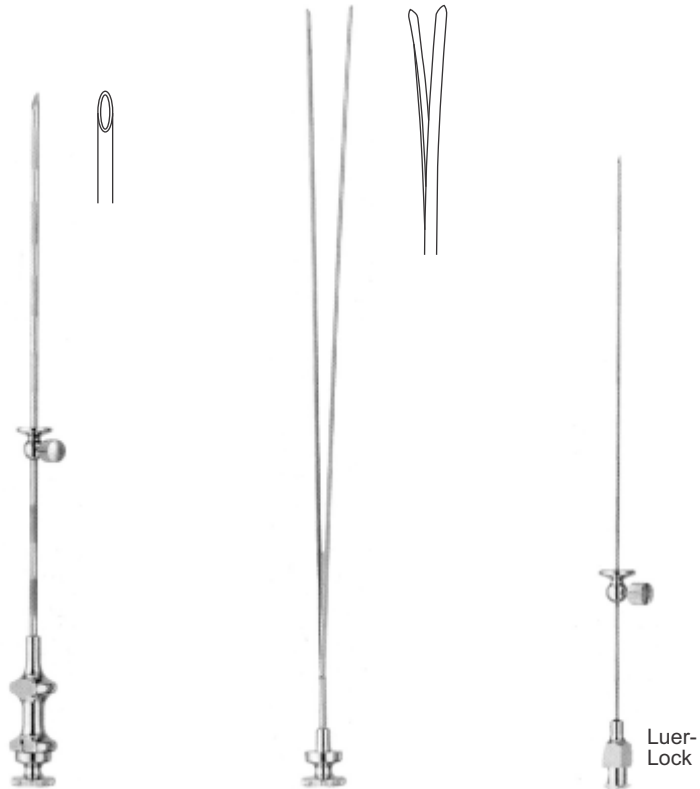

FRANKLIN-SILVERMAN  
modif. Fuchs

Luer-  
Lock

Set Complete	Biopsy cannulas	Split needles	Guide needles
NF.01.28.1#1	1.60 x 50	1.00 x 100	1.00 x 100
NF.01.28.1#2	1.80 x 105	1.20 x 155	1.00 x 150
NF.01.28.1#3	2.00 x 105	1.50 x 155	1.00 x 150
NF.01.28.1#4	2.00 x 130	1.50 x 180	1.00 x 150

# Probes, Cotton Carries, Suction Instruments

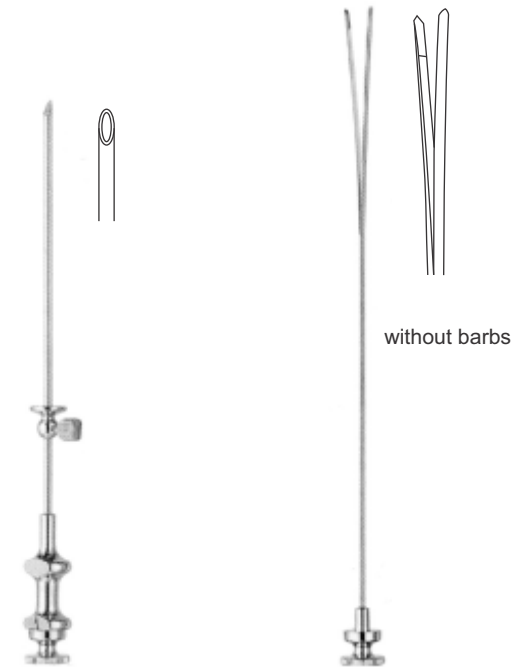

FRANKLIN-SILVERMAN

without barbs

Set Complete	Biopsy cannulas	Split needles
NF.01.28.21	2.00 x 60	1.50 x 105
NF.01.28.22	2.00 x 100	1.50 x 150
NF.01.28.23	2.50 x 145	2.00 x 195

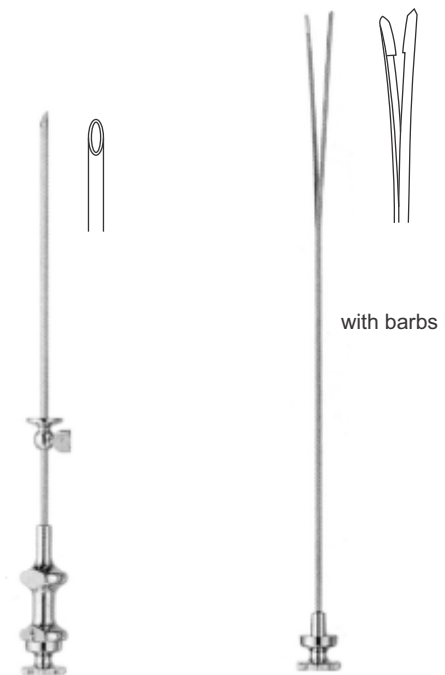

FRANKLIN-SILVERMAN

with barbs

Set Complete	Biopsy cannulas	Split needles
NF.01.28.41	2.00 x 60	1.50 x 105
NF.01.28.42	2.00 x 100	1.50 x 150
NF.01.28.43	2.50 x 145	2.00 x 195

**Probes, Cotton Carries, Suction Instruments**

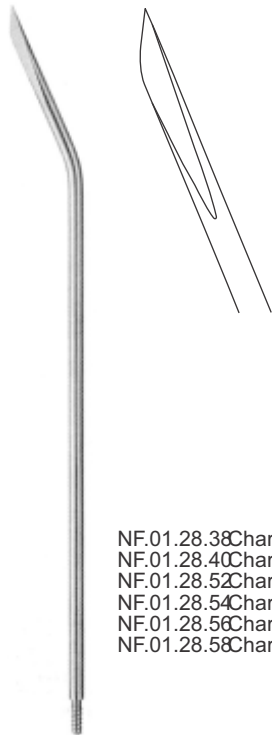

REDON

- NF.01.28.38 Charr. 8
- NF.01.28.40 Charr. 10
- NF.01.28.52 Charr. 12
- NF.01.28.54 Charr. 14
- NF.01.28.56 Charr. 16
- NF.01.28.58 Charr. 18



VERESS

- NF.01.28.82 2.0 x 100 mm
  - NF.01.28.84 2.0 x 125 mm
- Insufflation cannulas with stopcock

- NF.01.28.85 2.7 x 120 mm
- High flow insufflation cannulas with stopcock

Luer-Lock



Luer-Lock

- NF.01.28.86
- 0.8 x 120 mm



Luer-Lock

- NF.01.28.88
- 3-way stopcock

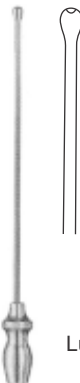

Cannulas with olive

Luer

- NF.01.28.90 1.0 x 80 mm
- NF.01.28.91 1.2 x 80 mm
- NF.01.28.92 1.4 x 80 mm
- NF.01.28.93 1.5 x 80 mm
- NF.01.28.94 1.6 x 80 mm
- NF.01.28.95 1.8 x 80 mm
- NF.01.28.96 2.0 x 80 mm

# Probes, Cotton Carries, Suction Instruments



**REDON**  
Knife edges

- NF.01.29.08Charr. 8
- NF.01.29.10Charr. 10
- NF.01.29.12Charr. 12
- NF.01.29.14Charr. 14
- NF.01.29.16Charr. 16
- NF.01.29.18Charr. 18



**QUINCKE**

- NF.01.29.270.70 x 80 mm
- NF.01.29.280.70 x 90 mm
- NF.01.29.301.00 x 80 mm
- NF.01.29.311.00 x 90 mm
- NF.01.29.321.20 x 90 mm
- NF.01.29.331.20 x 100 mm
- NF.01.29.341.20 x 150 mm



**TUOHY**

- NF.01.29.411.30 x 80 mm
- NF.01.29.421.50 x 80 mm
- NF.01.29.461.65 x 80 mm



**BIER**

- NF.01.29.521.20 x 80 mm
- NF.01.29.531.20 x 90 mm



**MENGHINI**

- NF.01.29.601.00 x 35 mm
- NF.01.29.611.00 x 70 mm
- NF.01.29.621.20 x 70 mm
- NF.01.29.631.20 x 100 mm
- NF.01.29.641.40 x 70 mm
- NF.01.29.651.40 x 100 mm
- NF.01.29.661.60 x 70 mm
- NF.01.29.671.80 x 80 mm
- NF.01.29.681.80 x 100 mm
- NF.01.29.691.40 x 168 mm
- NF.01.29.701.80 x 168 mm



**MENGHINI-RENALIS**

- NF.01.29.721.20 x 120 mm
- NF.01.29.741.40 x 120 mm
- NF.01.29.761.60 x 120 mm

Luer-Lock



for cannulas with Ø  
mm

- |             |      |
|-------------|------|
| NF.01.29.78 | 1.40 |
| NF.01.29.80 | 1.80 |

**Probes, Cotton Carries, Suction Instruments**

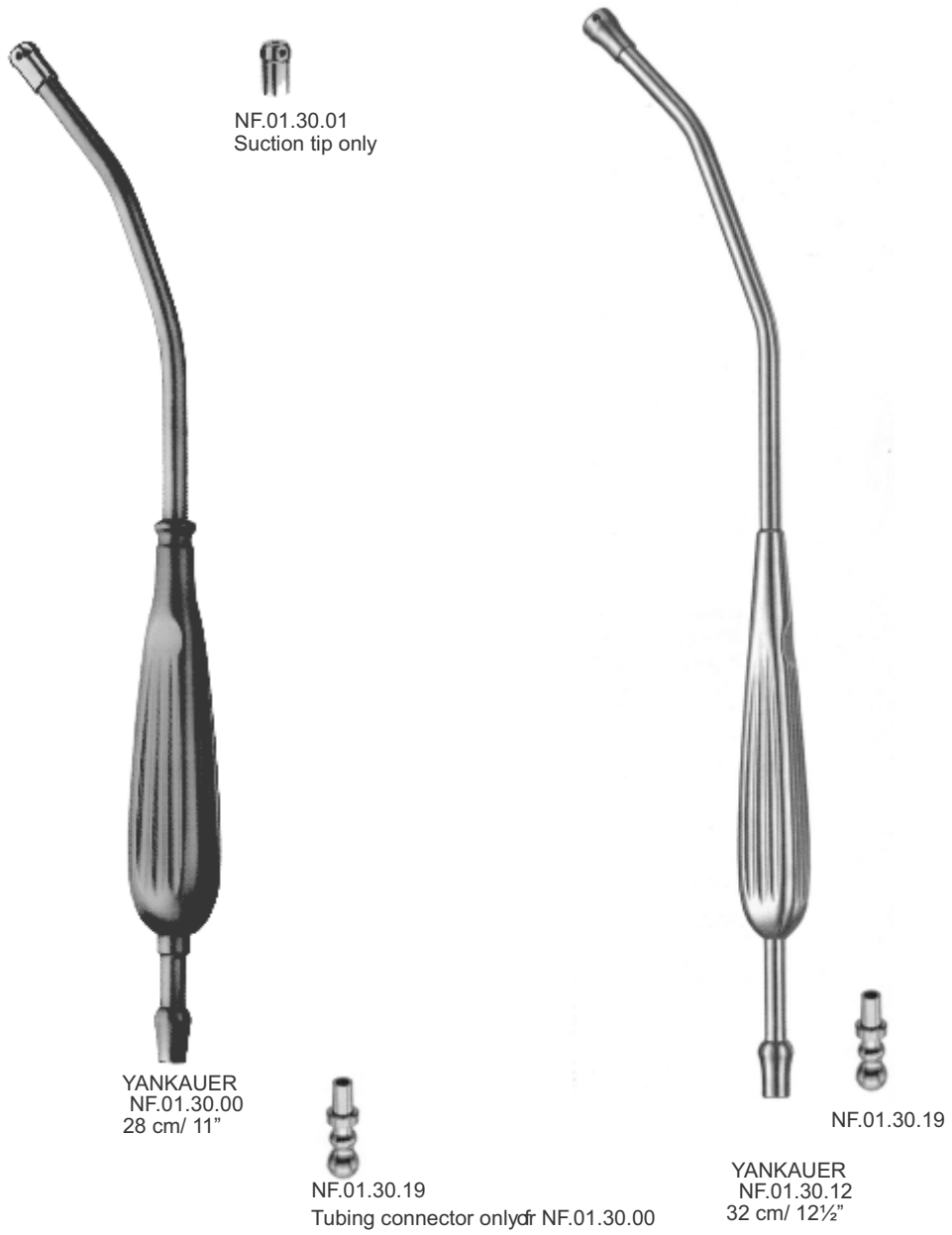



# Probes, Cotton Carries, Suction Instruments

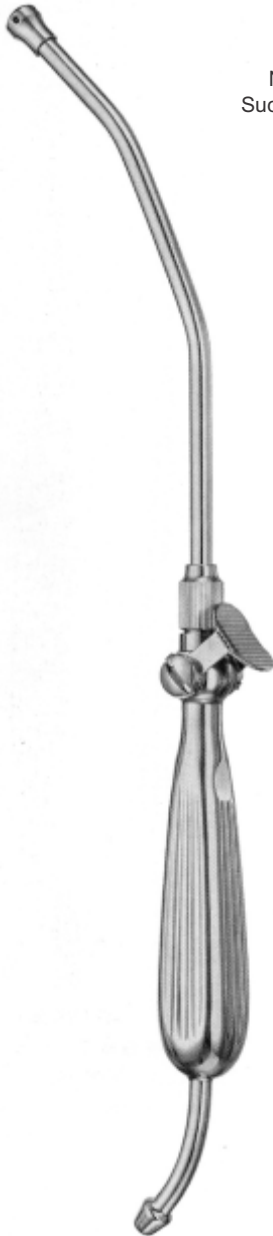

  
NF.01.31.15  
Suction tip only

  
NF.01.32.17  
Suction tip only

Cut-off valve

**YANKAUER**  
NF.01.31.06  
33 cm / 13"



**DEBAKEY**  
NF.01.32.07  
29 cm / 11"

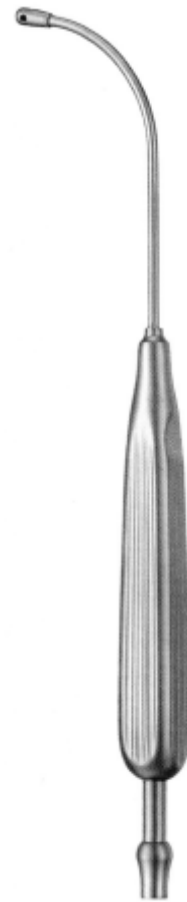

**ANDREWS-PYNCHON**  
NF.01.33.08  
24 cm / 9½"

**Probes, Cotton Carries, Suction Instruments**

Ø 8 mm

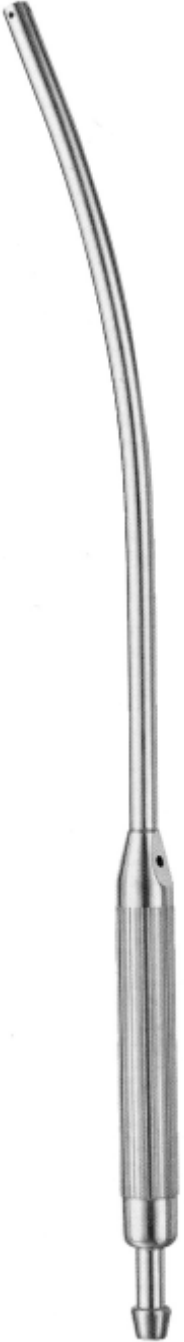

COOLEY  
NF.01.33.10  
36 cm/ 14"

Ø 8 mm



COOLEY  
NF.01.33.15  
30 cm/ 11¾"

Ø 9 mm



COOLEY  
NF.01.33.16  
30 cm/ 11¾"

Ø 8 mm



COOLEY  
NF.01.33.20  
33 cm/ 13"

13 cm - 5 1/8"

Ø 9 mm

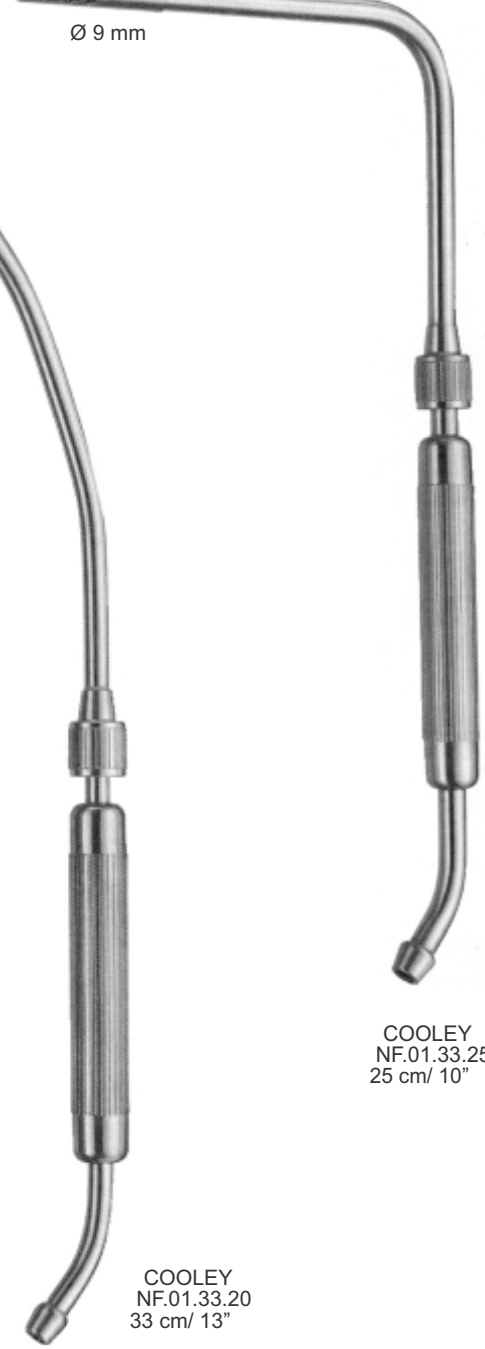

COOLEY  
NF.01.33.25  
25 cm/ 10"

# Probes, Cotton Carries, Suction Instruments



POOLE  
NF.01.34.18  
20 cm/ 8"  
Charr. 16.5 Ø 5.5 mm

NF.01.34.30  
23 cm/ 9"  
Charr. 30 Ø 10.0 mm



POOLE  
NF.01.35.18  
20 cm/ 8"  
Charr. 16.5 Ø 5.5 mm

NF.01.35.23  
23 cm/ 9"  
Charr. 23 Ø 8.0 mm

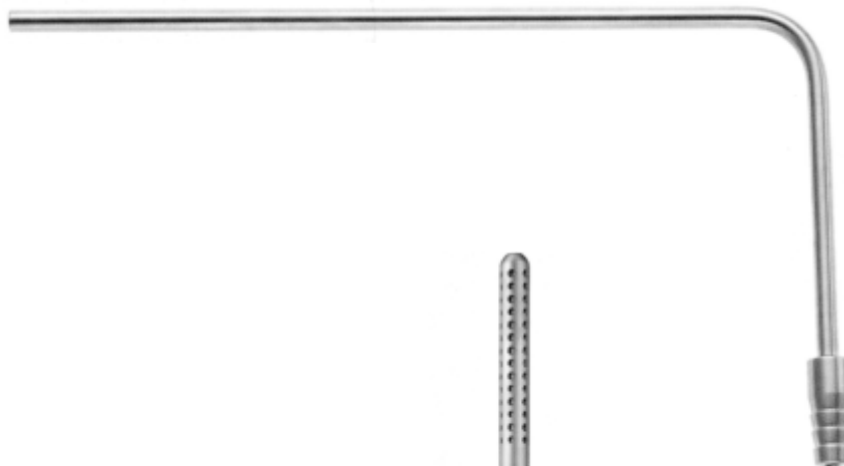

NF.01.35.30 Ø 6 mm  
21 cm/ 8¼"

NF.01.35.31 Ø 6 mm  
28 cm/ 11"

# Probes, Cotton Carries, Suction Instruments

Working length 12.5 cm

Luer  
♀

NF.01.36.06 Charr. 6  
NF.01.36.08 Charr. 8  
NF.01.36.10 Charr. 10  
NF.01.36.12 Charr. 12

FRAZIER

Working length 12.5 cm

Luer  
♀

NF.01.36.36 Charr. 6  
NF.01.36.38 Charr. 8  
NF.01.36.40 Charr. 10  
NF.01.36.42 Charr. 12  
NF.01.36.44 Charr. 15

FRAZIER (FERGUSSON)

Working length 18cm

Luer  
♀

NF.01.36.56 Charr. 6  
NF.01.36.58 Charr. 8  
NF.01.36.60 Charr. 10  
NF.01.36.62 Charr. 12

FRAZIER

Working length 18cm

Luer  
♀

NF.01.36.86 Charr. 6  
NF.01.36.88 Charr. 8  
NF.01.36.90 Charr. 10  
NF.01.36.92 Charr. 12

FRAZIER (FERGUSSON)

# Probes, Cotton Carries, Suction Instruments

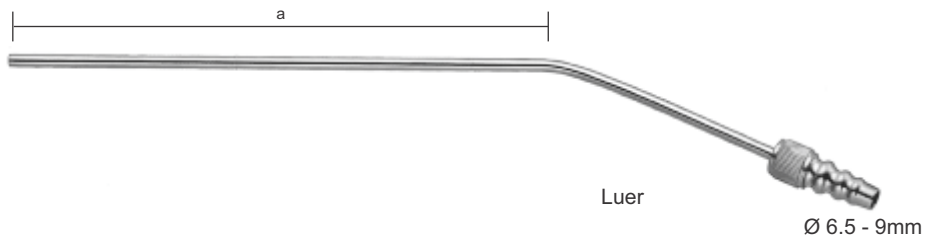
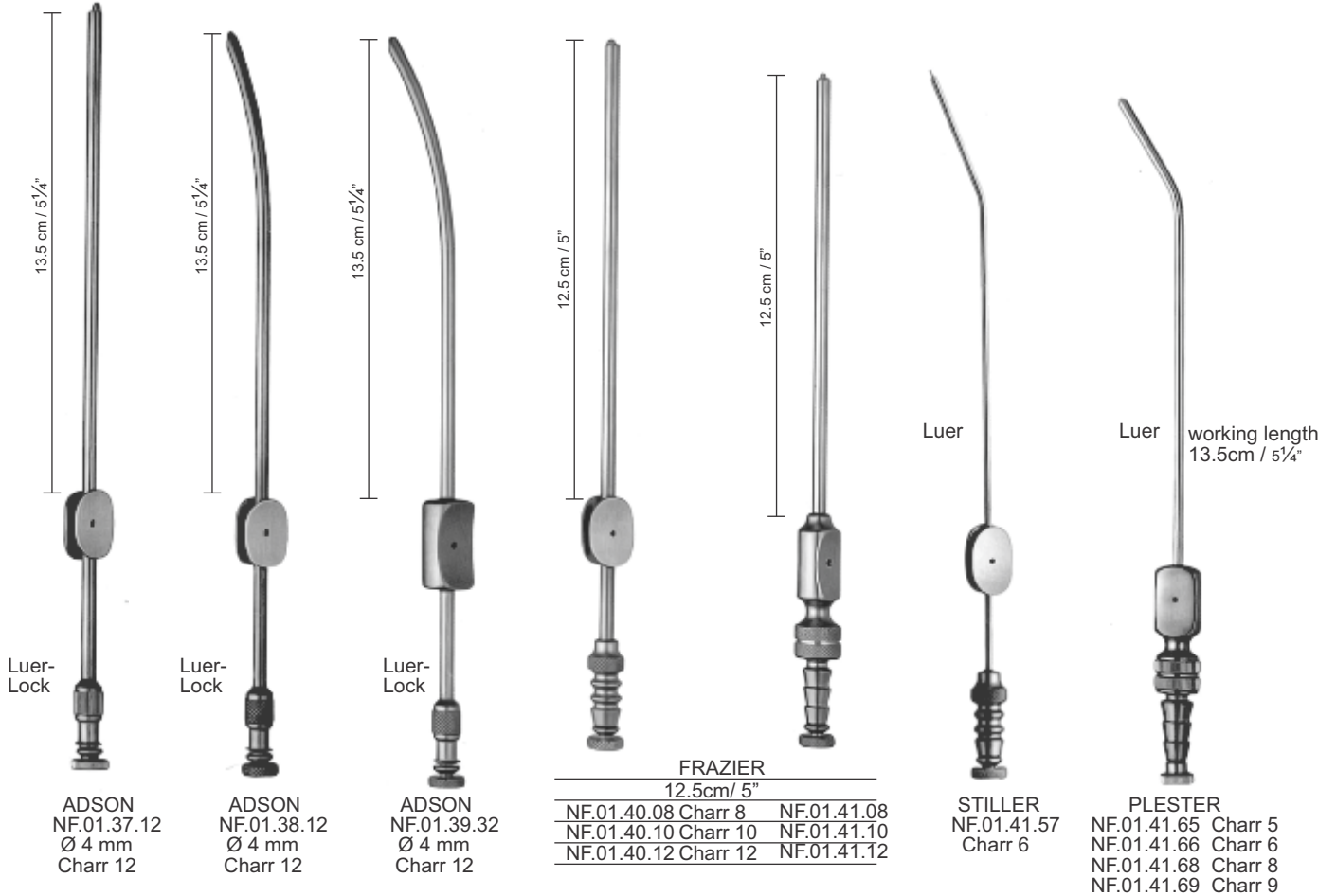

## YASARGIL

	Ø 1.5 mm	Ø 2 mm	Ø 2.5 mm	Ø 3.5 mm	Ø 4.5 mm
a = 13 cm - 5 1/8"	NF.01.41.13	NF.01.41.23	NF.01.41.33	NF.01.41.43	
a = 15 cm - 6"	NF.01.41.15	NF.01.41.25	NF.01.41.35	NF.01.41.45	
a = 18 cm - 7 1/8"	NF.01.41.18	NF.01.41.28	NF.01.41.38	NF.01.41.48	NF.01.41.58
a = 22 cm - 8 3/4"	NF.01.41.22	NF.01.41.32	NF.01.41.42	NF.01.41.52	

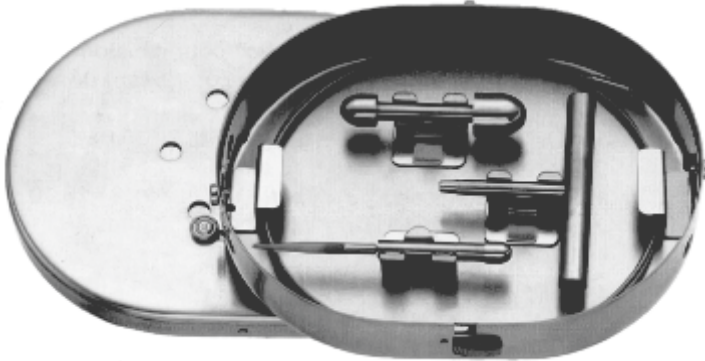

NABATOFF  
NF.01.42.00  
Varicose vein probe set complete in metal case



NF.01.43.11  
90cm / 35 3/8"  
Traction cable

NF.01.43.19  
Metal case only



NF.01.44.12  
Handle



NF.01.45.16  
Plastic probe tip



NF.01.46.18  
Metal probe tip



NF.01.47.26  
Ø 6 mm



NF.01.48.29  
Ø 9 mm



NF.01.49.32  
Ø 12 mm









NF.01.50.35  
Ø 15 mm

Olives

# Probes, Cotton Carries, Suction Instruments

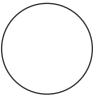
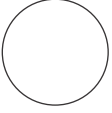

55cm/ 21¾"

- |   |   |   |   |   |
|---|---|---|---|---|
|  |  |  |  |  |
| NF.01.51.02<br>Ø 2 mm   | NF.01.52.03<br>Ø 3 mm   | NF.01.53.04<br>Ø 4 mm   | NF.01.54.06<br>Ø 6 mm   | NF.01.55.07<br>Ø 7 mm   |
|  |  |  |  |   |
| NF.01.56.08<br>Ø 8.5 mm   | NF.01.57.10<br>Ø 10 mm  | NF.01.58.12<br>Ø 12 mm  | NF.01.59.14<br>Ø 14 mm  |   |





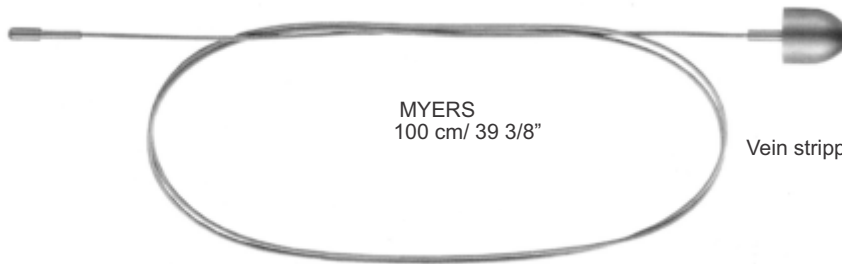

NF.01.60.19  
12 cm/ 4¾"

Handle for endarterectomy strippers





MYERS  
100 cm/ 39 3/8"

Vein strippers

- |   |   |   |   |
|---|---|---|---|
|  |  |  |  |
| NF.01.61.56<br>Ø 6 mm   | NF.01.61.59<br>Ø 9 mm   | NF.01.61.62<br>Ø 12 mm  | NF.01.61.65<br>Ø 15 mm  |

MYERS

# Probes, Cotton Carries, Suction Instruments

		
NF.01.73.48 4.8 mm	NF.01.73.72 7.2 mm	NF.01.73.96 9.6 mm
MAYO Inner Ø		

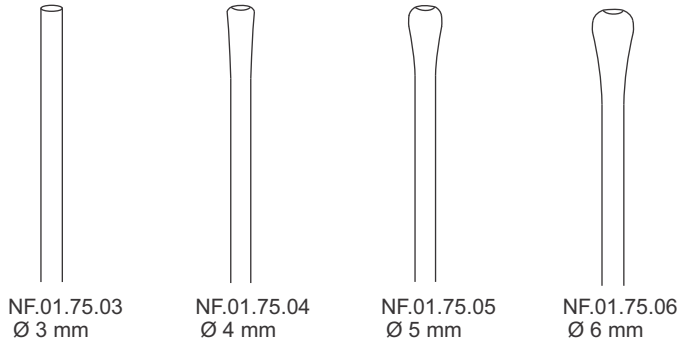

Vascular irrigation cannulas





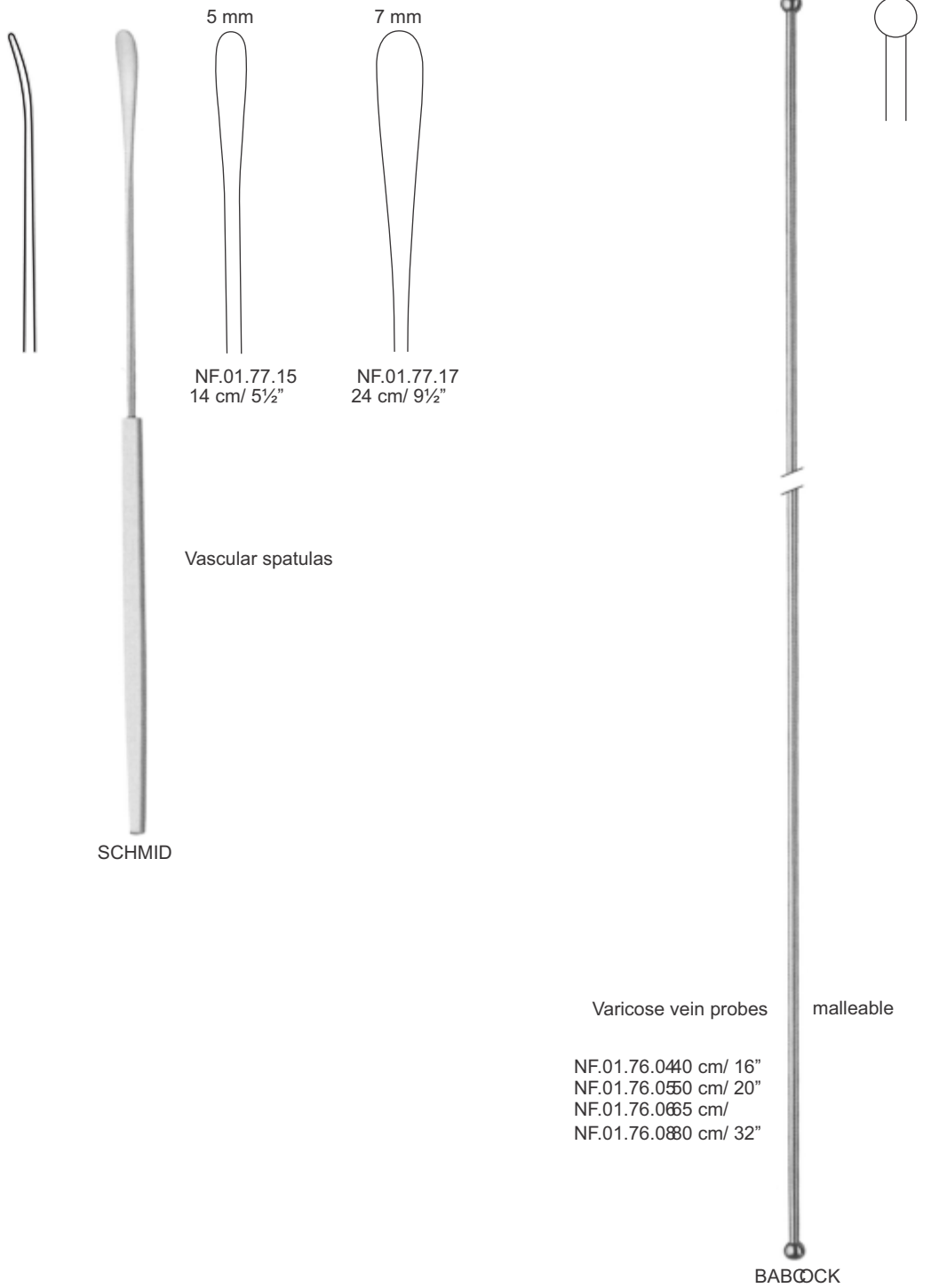

**SCISSORS**



# SCISSORS

**NS** Supercut scissors with their uniquely ground edges have with ultimate cutting efficiency. The special micro serrations in conjunction with the uniquely ground edges ensure precise, fine and minimally traumatising cuts.

**NS** scissors have fully gold-coloured screw for ease of identification.

The range of supercut scissors from **NS** comprises all models used routinely by surgeons: scissors for delicate and extremely delicate dissecting, e.g. Iris and Micro, models according to Metzenbaum in all possible lengths and design e.g. in a slim version for especially fine cutting to name but a few.

The supercut scissors can also be supplied with "TC" welded cutting edges of solid tungsten carbide alloy. The junction between the steel of the scissors and the tungsten carbide is seamless and homogenous. The welded cutting edges of solid tungsten carbide alloy guarantee excellent cutting quality and long life-span.

## Identification:

**NS** TC scissors:  
gold-coloured rings



**NS** supercut scissors:  
Black quoted shafts



**NS** supercut plus line scissors:  
one shaft gold plated and  
one shaft black quoted



**SCISSORS**



IRIS

	straight	curved	straight	curved	straight	curved	straight	curved
	9 cm/ 3½"		10.5 cm/ 4¼"		11.5 cm/ 4½"		12.5 cm/ 5"	
standard	NF.01.01.09	NF.01.02.09	NF.01.01.10	NF.01.02.10	NF.01.01.11	NF.01.02.11	NF.01.01.12	NF.01.02.12
"TC"					NF.01.05.61	NF.01.06.61		
supercut			NF.01.01.11	NF.01.02.11	NF.01.01.11	NF.01.02.11		NF.01.02.21
supercut plus					NF.01.05.16	NF.01.06.16		
black line	NF.01.01.21	NF.01.02.21	NF.01.01.21	NF.01.02.21				

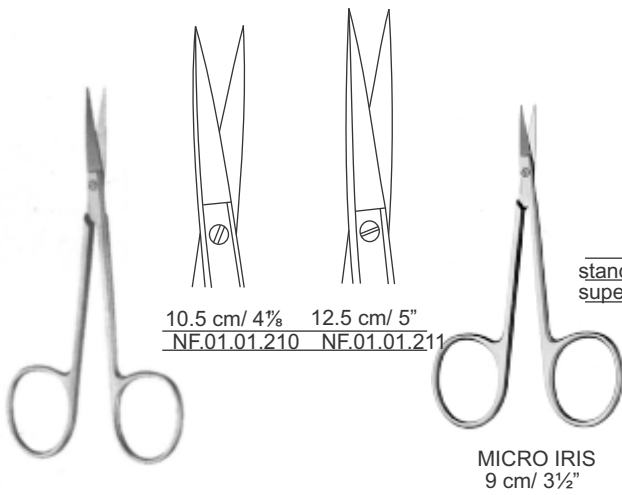

10.5 cm/ 4¼"    12.5 cm/ 5"  
NF.01.01.210    NF.01.01.211

MICRO IRIS  
9 cm/ 3½"

standard NF.01.03.30    NF.01.04.30  
supercut NF.01.03.130    NF.01.04.130



IRIS SELECT  
10.5 cm/ 4¼"

standard NF.01.03.40    NF.01.04.40



standard NF.01.03.71    NF.01.04.71

11.5 cm/ 4½"



standard NF.01.07.10    NF.01.08.10    NF.01.07.12    NF.01.08.12

10.5 cm/ 4¼"    12 cm/ 4¾"

# SCISSORS

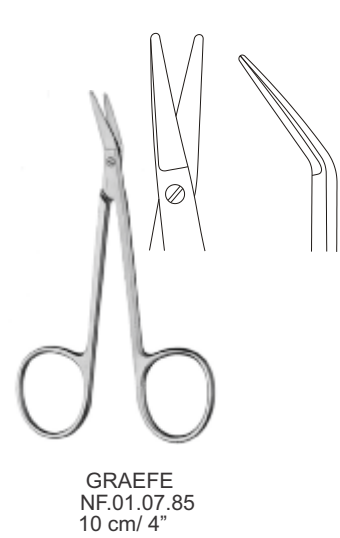
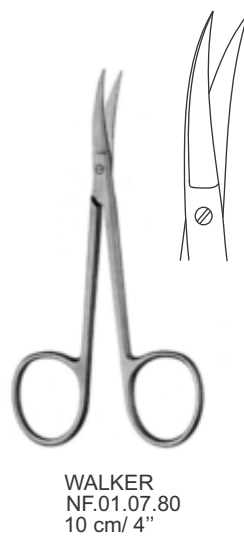
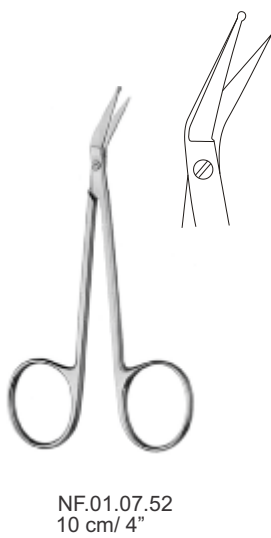
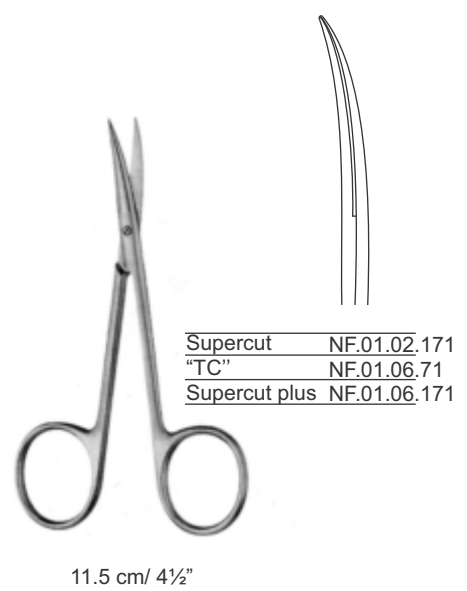
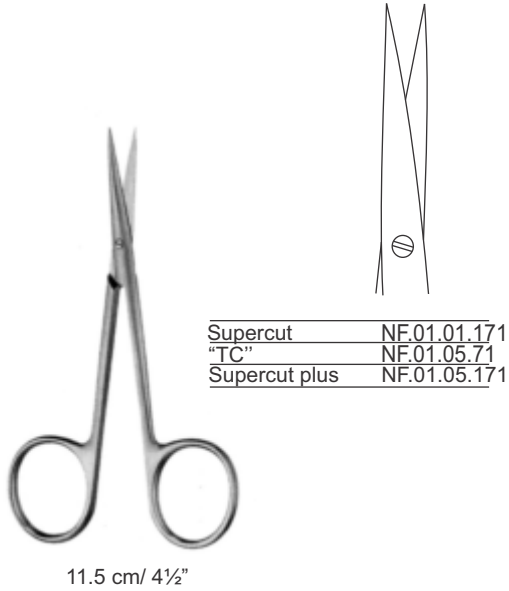

**SCISSORS**

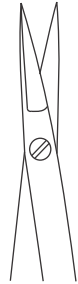

NF.01.07.109  
9.5 cm / 3¾"

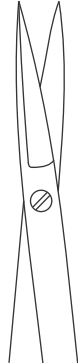

NF.01.07.110  
10.5 cm / 4⅛"



NF.01.08.109  
9.5 cm - 3¾"



NF.01.08.110  
10.5 cm / 4⅛"



BEUSE

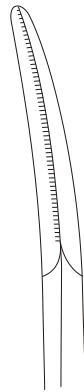
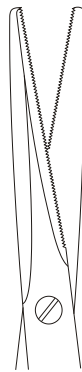
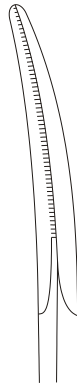
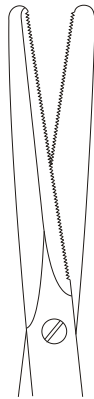

standard NF.01.08.14 NF.01.09.14 NF.01.08.18 NF.01.09.18  
14 cm / 5½" 18 cm / 7⅛"

# SCISSORS

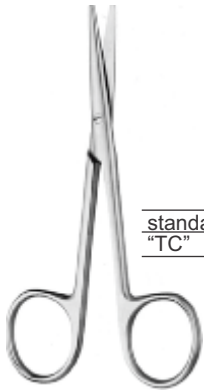

**LEXER BY**  
10 cm/4"

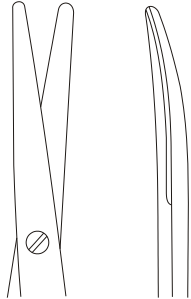

standard	NF.01.11.10	NF.01.12.10
"TC"	NF.01.13.60	NF.01.13.61



**KNAPP**  
12.5cm / 5"

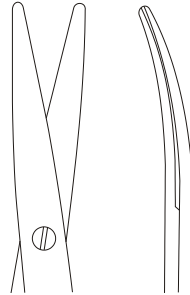

standard	NF.01.11.12	NF.01.12.12
"TC"	NF.01.13.62	NF.01.13.63
supercut	NF.01.11.112	NF.01.12.112
supercut plus	NF.01.13.162	NF.01.13.163
black line	NF.01.11.212	NF.01.12.212



**CHADWICK**  
NF.01.12.41  
11.5 cm/ 4½"

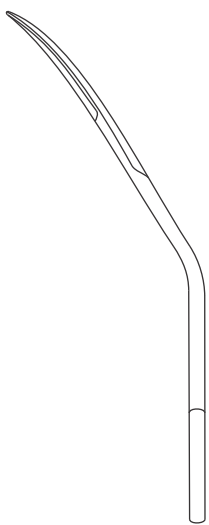

**NIRO**  
NF.01.119.14  
14 cm/ 5½"



**LAGRANGE**  
NF.01.120.14  
14 cm/ 5½"



**SCISSORS**

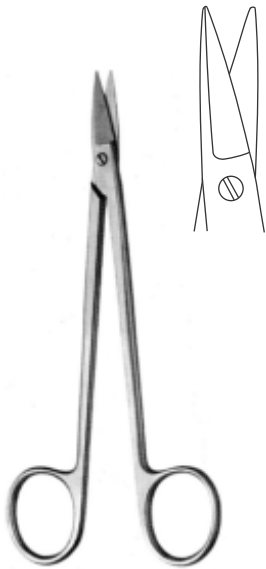

QUIMBY  
NF.01.110.13  
13 cm/ 5 1/8"



QUIMBY  
NF.01.111.13  
13 cm/ 5 1/8"



LOCKLIN  
16 cm/ 6 1/4"

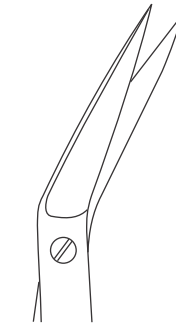

NF.01.115.15

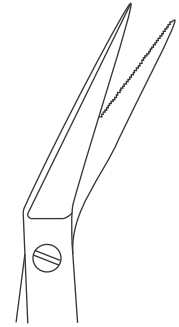

NF.01.115.16  
serrated cutting edges

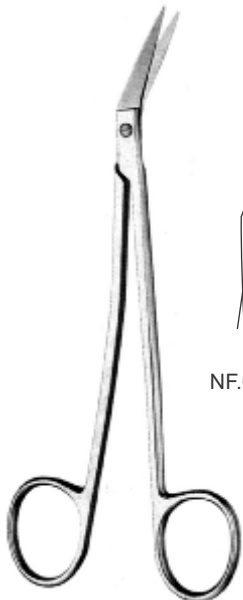

LOCKLIN  
16 cm/ 6 1/4"

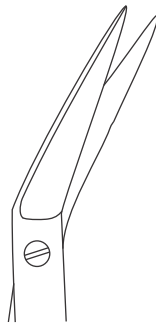

NF.01.116.26

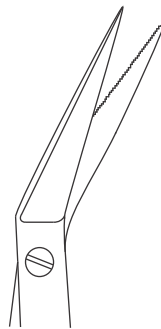

NF.01.116.27

serrated cutting edges



SISTRUNK  
NF.01.118.04  
14 cm/ 5 1/2"





# SCISSORS



NF.01.08.91  
NF.01.08.92 "TC"  
11.5 cm/4½"

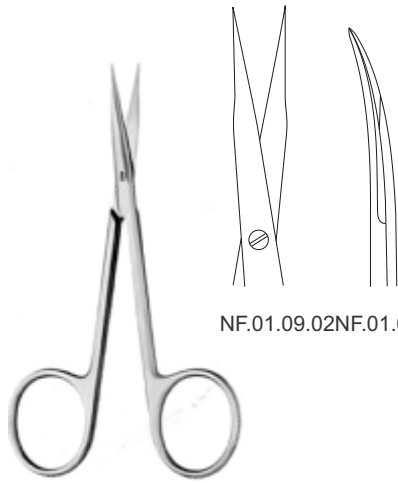

NF.01.09.02NF.01.09.03

STEVENS  
11.5 cm/4½"



NF.01.09.52  
11.5 cm/4½"

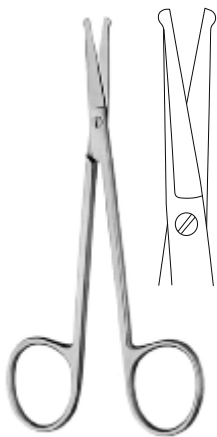

NF.01.09.62  
10.5 cm/ 4⅛"

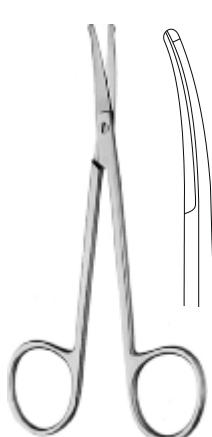

NF.01.09.63  
10.5 cm/ 4⅛"



NF.01.09.65  
10.5 cm/ 4⅛"

**SCISSORS**

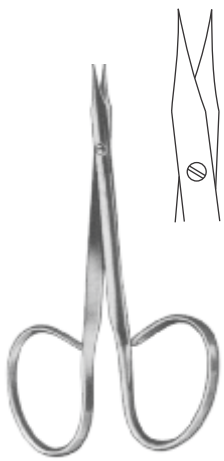

STEVENS  
NF.01.09.70  
10 cm / 4"

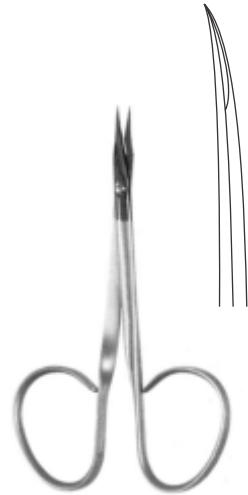

STEVENS  
NF.01.09.71  
10 cm / 4"

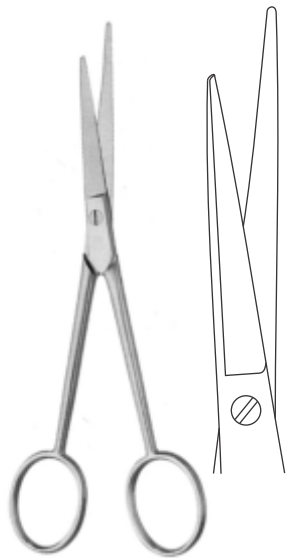

NF.01.09.84  
14.5 cm / 5¾"



STEVENS  
10 cm / 4"

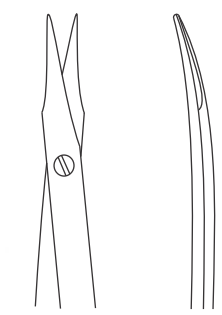

NF.01.10.70 NF.01.10.71



STEVENS  
11.5 cm / 4½"

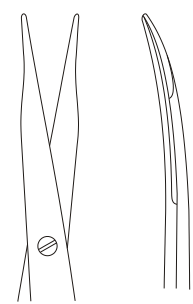

standard	NF.01.10.12	NF.01.10.13
supercut	NF.01.10.112	NF.01.10.113
black line	NF.01.10.212	NF.01.10.213



STEVENS  
11.5 cm / 4½"

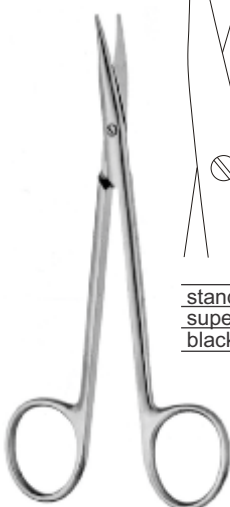

STEVENS



	13 cm / 5½"	15 cm / 6"	18 cm / 7½"
standard	NF.01.10.15		
supercut	NF.01.10.115	NF.01.10.116	NF.01.10.118
black line	NF.01.10.215		

# SCISSORS

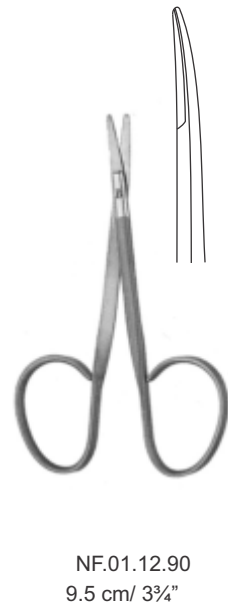
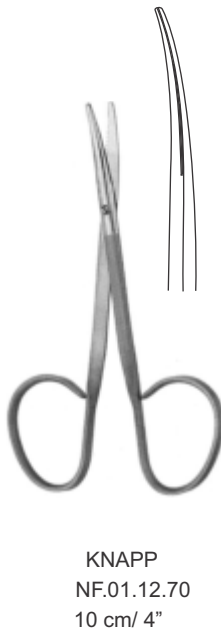
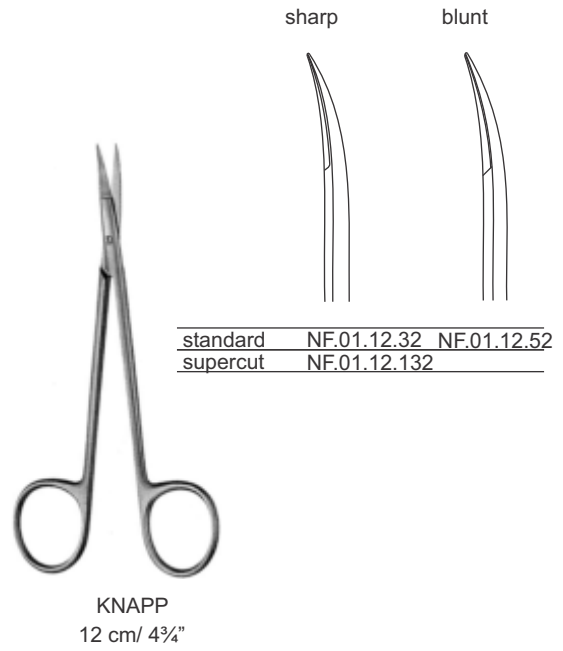
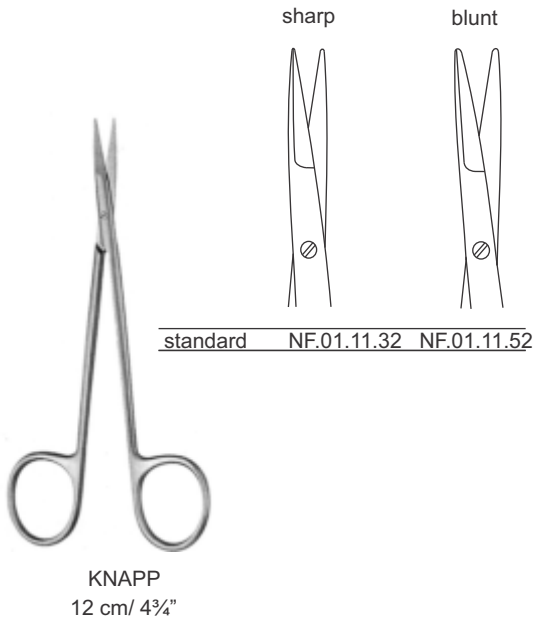

# SCISSORS

## blunt/blunt



straight

	straight	straight	straight	straight
	10.5 cm/ 4 $\frac{1}{8}$ "	11.5 cm/ 4 $\frac{1}{2}$ "	13 cm/ 5 $\frac{1}{8}$ "	14.5 cm/ 5 $\frac{3}{4}$ "
standard	NF.01.14.10	NF.01.14.11	NF.01.14.13	NF.01.14.14
"TC"				NF.01.14.64
supercut			NF.01.14.113	NF.01.14.114
black line				NF.01.14.214

	15 cm/ 6"	16.5 cm/ 6 $\frac{1}{2}$ "	17.5 cm/ 7"	18.5 cm/ 7 $\frac{1}{4}$ "
standard	NF.01.14.15	NF.01.14.16	NF.01.14.17	NF.01.14.18

	20cm/ 8"
standard	NF.01.14.20

	curved	curved	curved	curved
	10.5 cm/ 4 $\frac{1}{8}$ "	11.5 cm/ 4 $\frac{1}{2}$ "	13 cm/ 5 $\frac{1}{8}$ "	14.5 cm/ 5 $\frac{3}{4}$ "
standard	NF.01.18.10	NF.01.18.11	NF.01.18.13	NF.01.18.14
"TC"				NF.01.18.64
supercut			NF.01.18.113	NF.01.18.114
black line				NF.01.18.214

	15 cm/ 6"	16.5 cm/ 6 $\frac{1}{2}$ "	17.5 cm/ 7"	18.5cm/ 7 $\frac{1}{4}$ "
standard	NF.01.18.15	NF.01.18.16	NF.01.18.17	NF.01.18.18

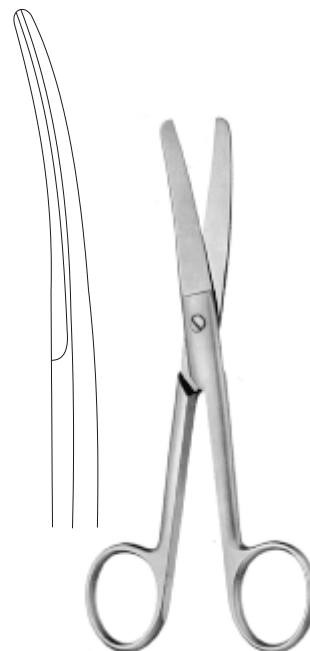

curved

## sharp/sharp

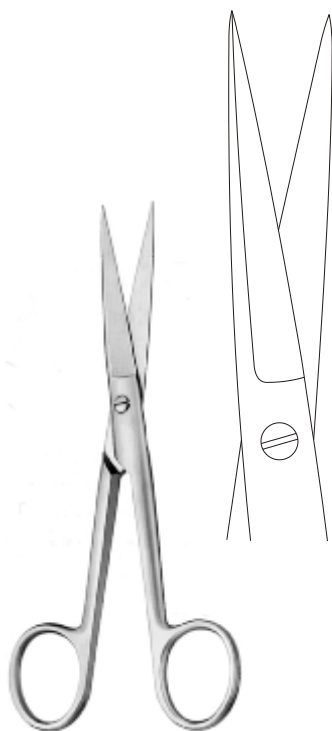

straight

	straight	straight	straight	straight
	10.5 cm/ 4 $\frac{1}{8}$ "	11.5 cm/ 4 $\frac{1}{2}$ "	13 cm/ 5 $\frac{1}{8}$ "	14.5 cm/ 5 $\frac{3}{4}$ "
standard	NF.01.15.10	NF.01.15.11	NF.01.15.13	NF.01.15.14
"TC"				NF.01.15.64
supercut			NF.01.15.113	NF.01.15.114
black line				NF.01.15.214

	15 cm/ 6"	16.5 cm/ 6 $\frac{1}{2}$ "	17.5 cm/ 7"	18.5 cm/ 7 $\frac{1}{4}$ "
standard	NF.01.15.15	NF.01.15.16	NF.01.15.17	NF.01.15.18

	curved	curved	curved	curved
	10.5 cm/ 4 $\frac{1}{8}$ "	11.5 cm/ 4 $\frac{1}{2}$ "	13 cm/ 5 $\frac{1}{8}$ "	14.5 cm/ 5 $\frac{3}{4}$ "
standard	NF.01.19.10	NF.01.19.11	NF.01.19.13	NF.01.19.14
"TC"				NF.01.19.64
supercut			NF.01.19.113	NF.01.19.114
black line				NF.01.19.214

	15 cm/ 6"	16.5cm/ 6 $\frac{1}{2}$ "	17.5 cm/ 7"	18.5 cm/ 7 $\frac{1}{4}$ "
standard	NF.01.19.15	NF.01.19.16	NF.01.19.17	NF.01.19.18

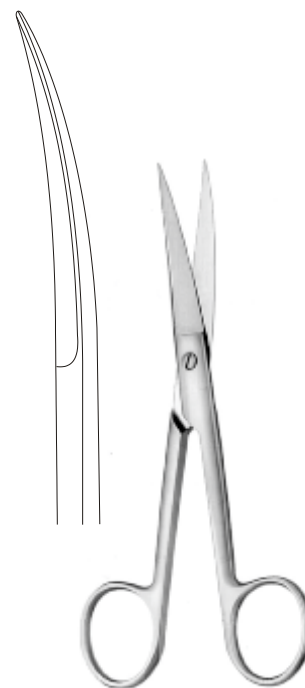

curved

# SCISSORS

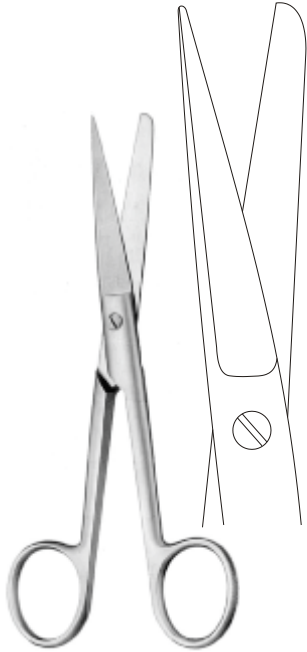

straight

sharp/blunt				
	straight	straight	straight	straight
	10.5 cm/ 4 <sup>1</sup> / <sub>8</sub> "	11.5 cm/ 4 <sup>1</sup> / <sub>2</sub> "	13 cm/ 5 <sup>1</sup> / <sub>8</sub> "	14.5 cm/ 5 <sup>3</sup> / <sub>4</sub> "
standard	NF.01.16.10	NF.01.16.11	NF.01.16.13	NF.01.16.14
"TC"				NF.01.16.64
supercut			NF.01.16.113	NF.01.16.114
black line				NF.01.16.214
◀	15 cm/ 6"	16.5 cm/ 6 <sup>1</sup> / <sub>2</sub> "	17.5 cm/ 7"	18.5 cm/ 7 <sup>1</sup> / <sub>4</sub> "
standard	NF.01.16.15	NF.01.16.16	NF.01.16.17	NF.01.16.18
	20 cm/ 8"			
standard	NF.01.16.20			
	curved	curved	curved	curved
	10.5 cm/ 4 <sup>1</sup> / <sub>8</sub> "	11.5 cm/ 4 <sup>1</sup> / <sub>2</sub> "	13 cm/ 5 <sup>1</sup> / <sub>8</sub> "	14.5 cm/ 5 <sup>3</sup> / <sub>4</sub> "
standard	NF.01.17.10	NF.01.17.11	NF.01.17.13	NF.01.17.14
"TC"				NF.01.17.64
supercut			NF.01.17.113	NF.01.17.114
black line				NF.01.17.214
	15 cm/ 6"	16.5 cm/ 6 <sup>1</sup> / <sub>2</sub> "	17.5 cm/ 7"	18.5 cm/ 7 <sup>1</sup> / <sub>4</sub> "
standard	NF.01.17.15	NF.01.17.16	NF.01.17.17	NF.01.17.18
	20 cm/ 8"			
standard	NF.01.17.20			

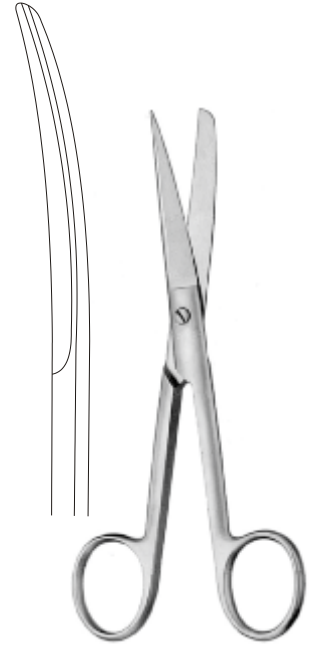

curved

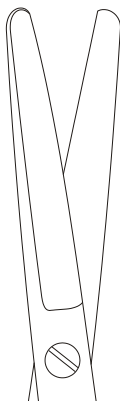

straight  
NF.01.14.83  
13 cm/ 5<sup>1</sup>/<sub>8</sub>"

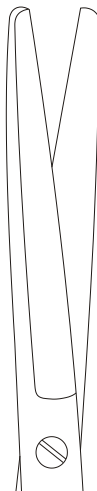

straight  
NF.01.14.84  
14.5 cm/ 5<sup>3</sup>/<sub>4</sub>"



curved  
NF.01.18.83  
13 cm/ 5<sup>1</sup>/<sub>8</sub>"



curved  
NF.01.18.84  
14.5 cm/ 5<sup>3</sup>/<sub>4</sub>"

**SCISSORS**

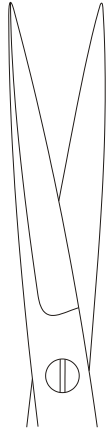

straight  
NF.01.15.83  
13 cm/ 5½"



straight  
NF.01.15.84  
14.5 cm/ 5¾"



curved  
NF.01.19.83  
13 cm/ 5½"

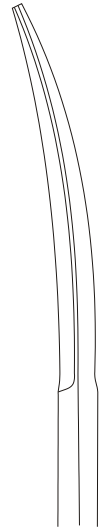

curved  
NF.01.19.84  
14.5 cm/ 5¾"

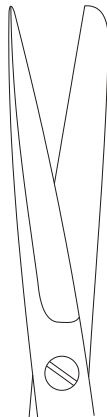

straight  
NF.01.16.83  
13 cm/ 5½"

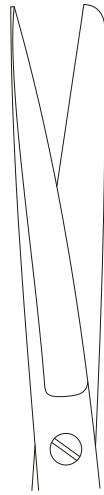

straight  
NF.01.16.84  
14.5 cm/ 5¾"



curved  
NF.01.17.83  
13 cm/ 5½"

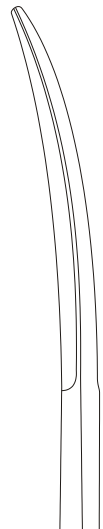

curved  
NF.01.17.84  
14.5 cm/ 5¾"

# SCISSORS

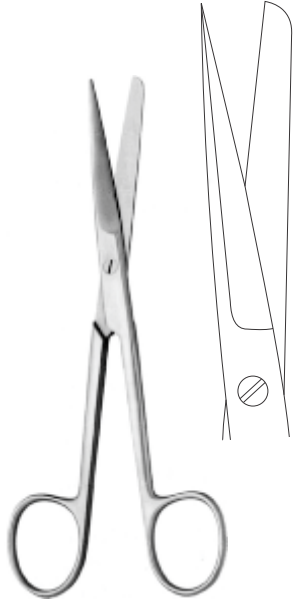

DEAVER  
NF.01.20.14  
14 cm/ 5½"



DEAVER  
NF.01.21.14  
14 cm/ 5½"



DEAVER  
NF.01.21.34  
14 cm/ 5½"

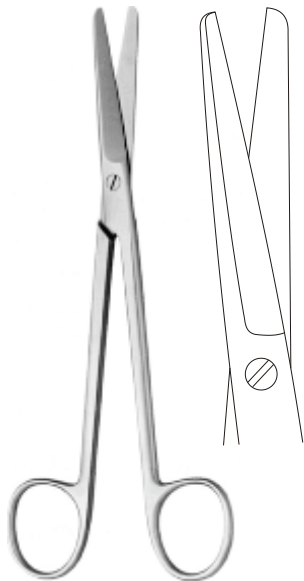

MIXTER  
NF.01.22.55  
15.5 cm/ 6¼"



MIXTER  
NF.01.23.55  
15.5 cm/ 6¼"

**SCISSORS**



**DOYEN**  
18 cm / 7 1/8"



straight curved

standard	NF.01.22.18	NF.01.23.18
supercut	NF.01.22.118	NF.01.23.118
black line	NF.01.22.218	NF.01.23.218



**WERTHEIM**

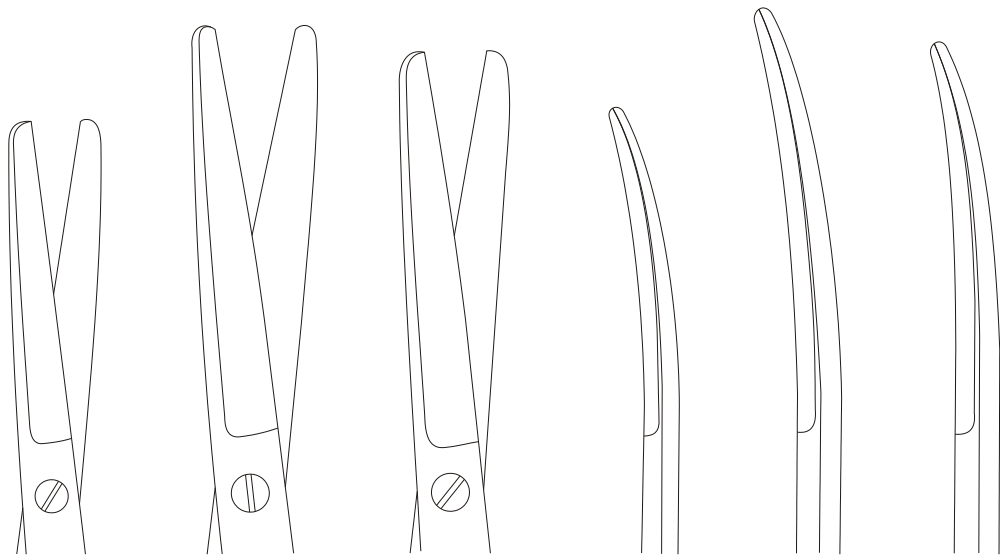

straight  
NF.01.22.24  
14.5 cm / 5 3/4"

straight  
NF.01.22.30  
20 cm / 8"

straight  
NF.01.22.33  
23 cm / 9"

curved  
NF.01.23.24  
14.5 cm / 5 3/4"

curved  
NF.01.23.30  
20 cm / 8"

curved  
NF.01.23.33  
23 cm / 9"



# SCISSORS

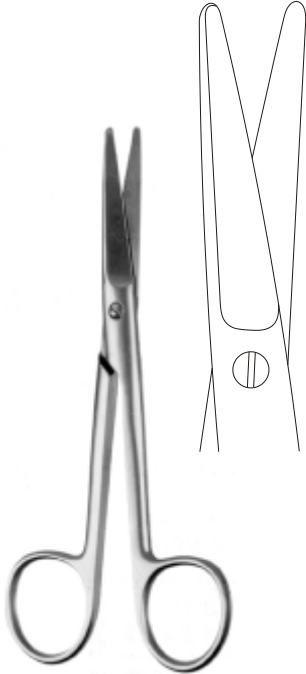

MAYO straight



MAYO curved

	straight	straight	straight	straight
	14 cm/ 5½"	15.5 cm/ 6⅛"	17 cm/ 6¾"	23 cm/ 9"
standard	NF.01.24.14	NF.01.24.15	NF.01.24.17	NF.01.24.23
"TC"	NF.01.24.64	NF.01.24.65	NF.01.24.67	NF.01.24.73
supercut	NF.01.24.114	NF.01.24.115	NF.01.24.117	NF.01.24.123
supercut plus	NF.01.24.164	NF.01.24.165	NF.01.24.167	NF.01.24.173
black line	NF.01.24.214		NF.01.24.217	NF.01.24.223

	curved	curved	curved	curved
	14 cm/ 5½"	15.5 cm/ 6⅛"	17 cm/ 6¾"	23 cm/ 9"
standard	NF.01.25.14	NF.01.25.15	NF.01.25.17	NF.01.25.23
"TC"	NF.01.25.64	NF.01.25.65	NF.01.25.67	NF.01.25.73
supercut	NF.01.25.114	NF.01.25.115	NF.01.25.117	NF.01.25.123
supercut plus	NF.01.25.164	NF.01.25.165	NF.01.25.167	NF.01.25.173
black line	NF.01.25.214		NF.01.25.217	NF.01.25.223



MAYO-HARRINGTON straight

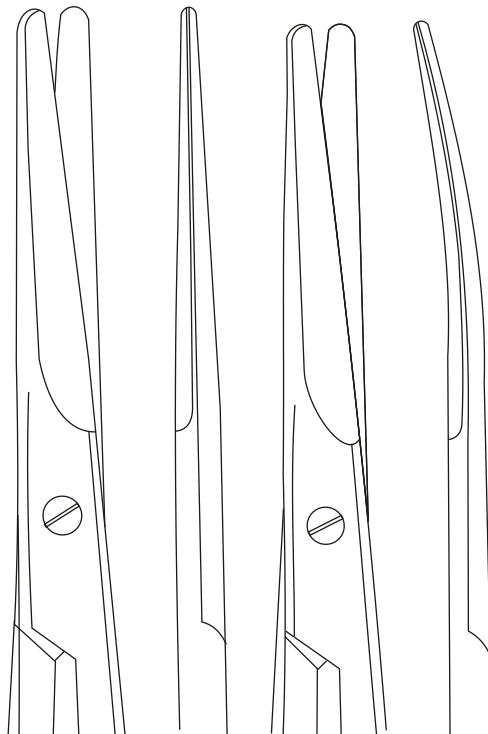

	straight	straight	curved	curved
	20cm/ 8"	23cm/ 9"	20cm/ 8"	23cm/ 9"
standard	NF.01.24.80	NF.01.24.83	NF.01.25.80	NF.01.25.83
"TC"	NF.01.24.81	NF.01.24.84	NF.01.25.81	NF.01.25.84



MAYO-HARRINGTON curved

**SCISSORS**



SIMS

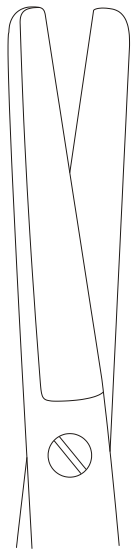

20cm/ 8"      23cm/ 9"

standard	NF.01.26.20	NF.01.26.23
supercut	NF.01.26.120	

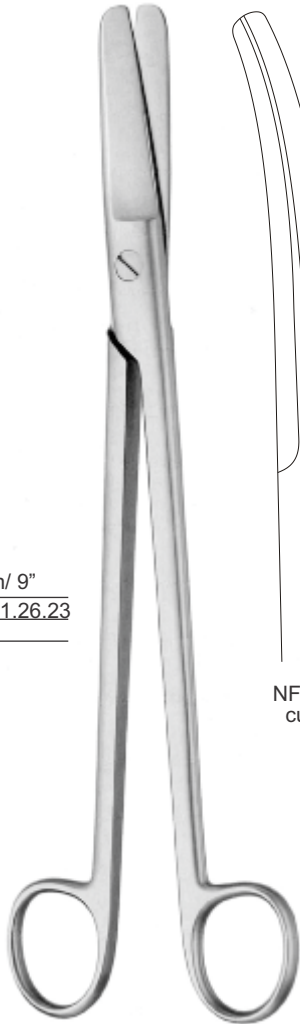

DUBOIS  
NF.01.26.27  
27 cm/ 10¾"  
straight

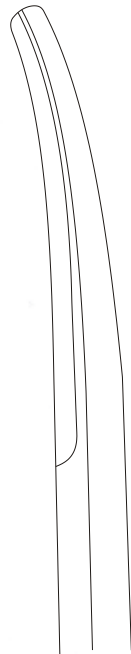

NF.01.26.47  
curved



SIMS

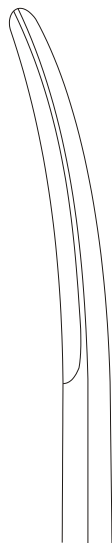

20cm/ 8"      23cm/ 9"

standard	NF.01.27.20	NF.01.27.23
"TC"	NF.01.27.50	
supercut	NF.01.27.120	NF.01.27.123
supercut plus	NF.01.27.150	
black line	NF.01.27.220	NF.01.27.223



SIMS

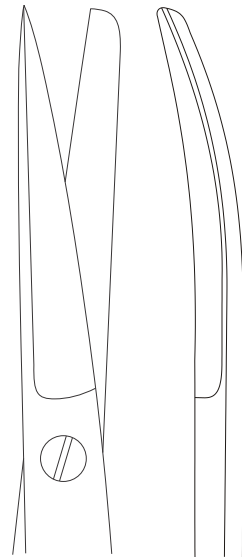

20cm/ 8"      23cm/ 9"

straight	NF.01.26.40	NF.01.26.43
curved	NF.01.27.40	NF.01.27.43

# SCISSORS



MAYO  
"TC"

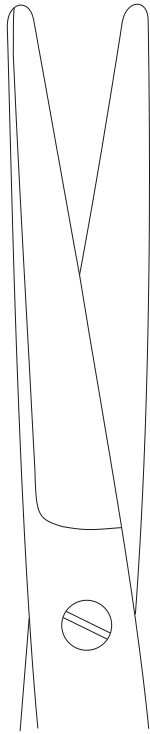

32 cm / 12½"



NF.01.28.73



NF.01.28.74

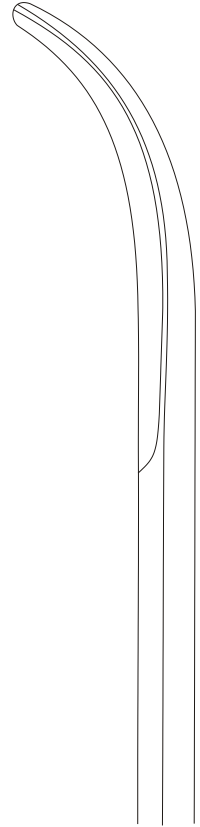

NF.01.28.75

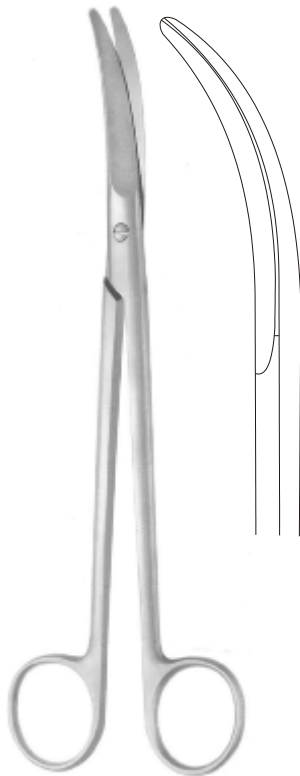

MAYO

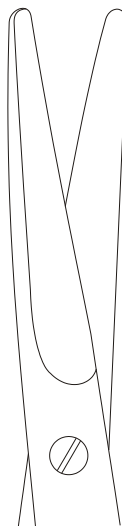

NF.01.29.118  
18 cm / 7¼"  
supercut

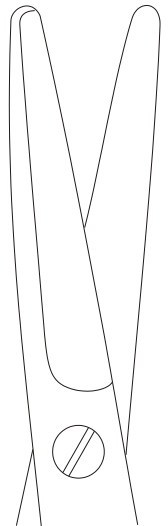

NF.01.29.123  
23 cm / 9"  
supercut

**SCISSORS**

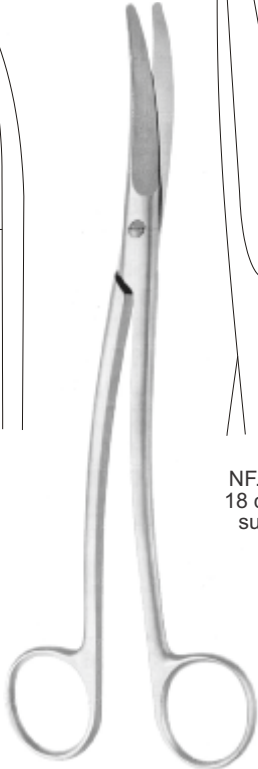
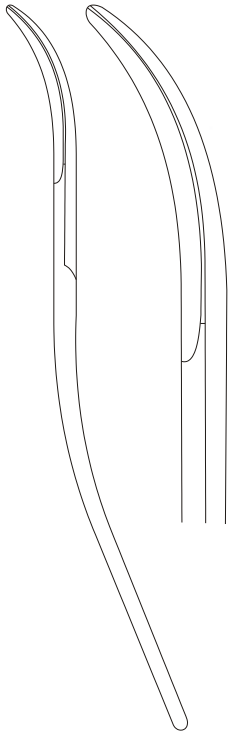

**MAYO**

NF.01.29.138  
18 cm / 7 1/8"  
supercut

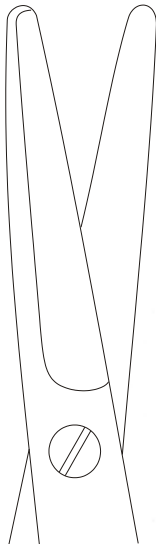
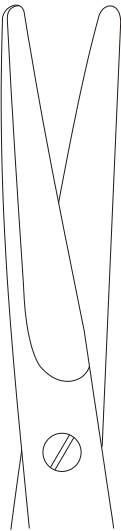

NF.01.29.143  
23 cm / 9"  
supercut

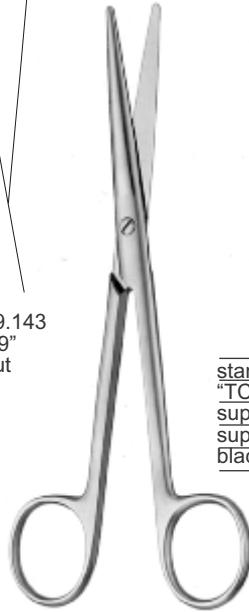

**MAYO-LEXER**  
16 cm / 6 1/4"

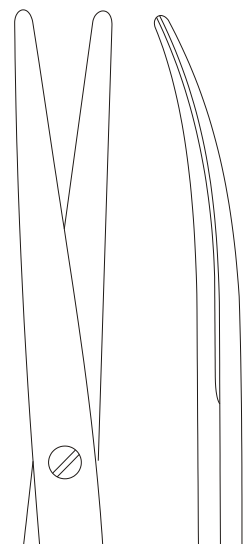

	straight	curved
standard	NF.01.32.86	NF.01.32.87
"TC"	NF.01.34.96	NF.01.35.96
supercut	NF.01.32.186	NF.01.32.187
supercut plus	NF.01.34.196	NF.01.35.196
black line	NF.01.32.286	NF.01.32.287



**LEXER**  
16.5 cm / 6 1/2"

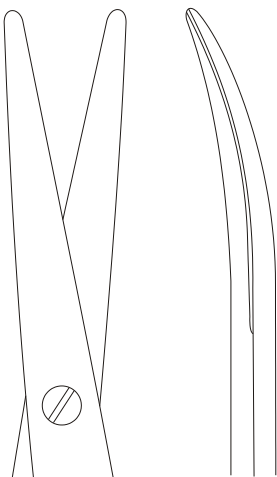

standard	NF.01.32.17
"TC"	NF.01.32.97
supercut	NF.01.32.117
supercut plus	NF.01.32.197
black line	NF.01.32.217



**MAYO-NOBLE**  
17 cm / 6 3/4"

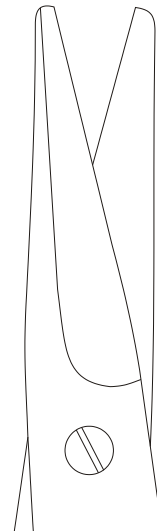

NF.01.33.17  
straight



NF.01.34.17  
curved

# SCISSORS



MAYO  
"TC"

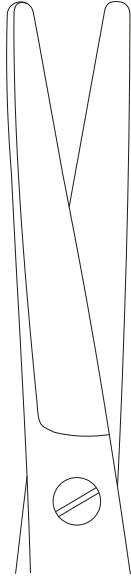

23 cm/ 9"



NF.01.26.73



NF.01.26.74

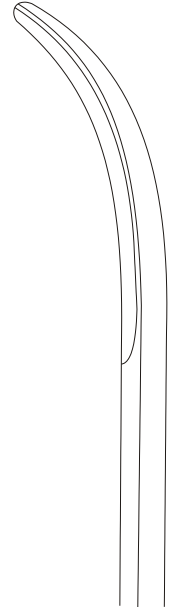

NF.01.26.75

Parametrium scissors



28 cm/ 11"



NF.01.27.73



NF.01.27.74

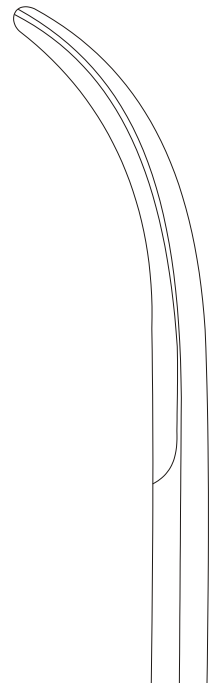

NF.01.27.75

**SCISSORS**

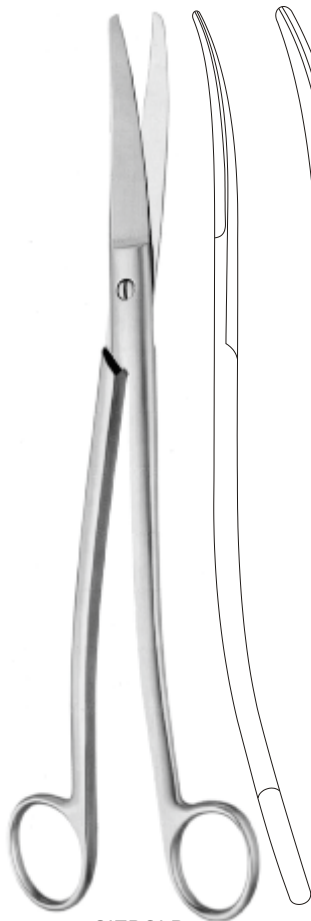

**SIEBOLD**

24.5 cm/ 9¾"

standard	NF.01.27.24
supercut	NF.01.27.124

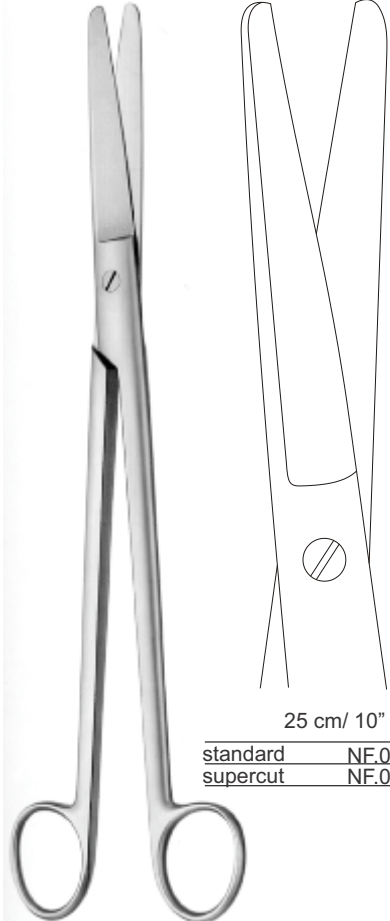

**SIMS-SIEBOLD**

25 cm/ 10"

standard	NF.01.27.25
supercut	NF.01.27.125

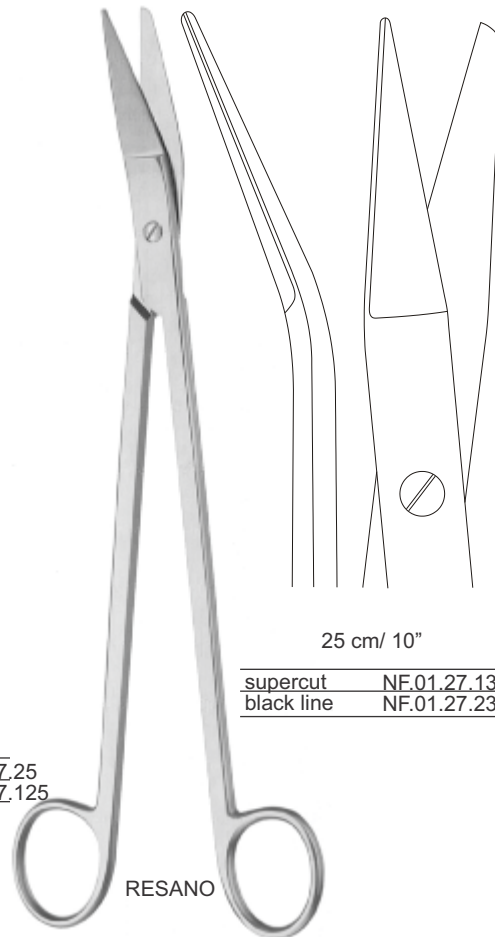

**RESANO**

25 cm/ 10"

supercut	NF.01.27.135
black line	NF.01.27.235



**MAYO-STILLE**



	straight	curved	straight	curved	straight	curved
	15 cm/ 6"	15 cm/ 6"	17 cm/ 6¾"	17 cm/ 6¾"	23 cm/ 9"	23 cm/ 9"
standard	NF.01.28.15	NF.01.30.15	NF.01.28.17	NF.01.30.17	NF.01.28.23	NF.01.30.23
"TC"	NF.01.29.65	NF.01.31.65	NF.01.29.67	NF.01.31.67		
supercut	NF.01.28.115	NF.01.30.115	NF.01.28.117	NF.01.30.117		
supercut plus	NF.01.29.165	NF.01.31.165	NF.01.29.167	NF.01.31.167		
black line	NF.01.28.215	NF.01.30.215	NF.01.28.217	NF.01.30.217		



**MAYO-STILLE**

# SCISSORS



standard	NF.01.36.11	NF.01.37.11
"TC"	NF.01.36.61	NF.01.37.61
supercut	NF.01.36.111	NF.01.37.111
supercut plus	NF.01.36.161	NF.01.37.161
black line	NF.01.36.211	NF.01.37.211

**BABY-METZENBAUM**  
11.5 cm / 4½"

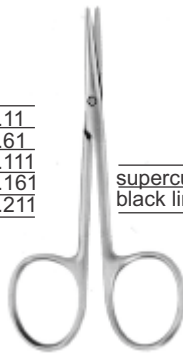

	straight	curved
supercut	NF.01.36.109	NF.01.37.109
black line	NF.01.36.209	NF.01.37.209

**MINI-METZENBAUM**  
9 cm / 3½"

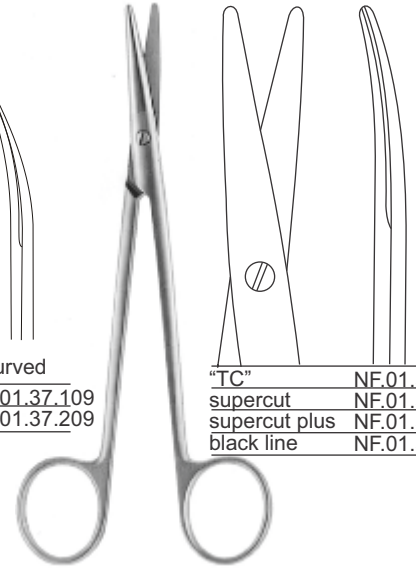

"TC"	NF.01.37.63
supercut	NF.01.39.113
supercut plus	NF.01.37.163
black line	NF.01.39.213

**METZENBAUM**  
14 cm / 5½"



**METZENBAUM**

	straight	straight	straight	curved	curved	curved	curved
	14 cm / 5½"	18 cm / 7⅛"	20cm / 8"	14 cm / 5½"	15 cm / 6"	18 cm / 7⅛"	20cm / 8"
standard	NF.01.36.14	NF.01.38.18	NF.01.38.20	NF.01.37.14	NF.01.37.15	NF.01.39.18	NF.01.39.20
"TC"	NF.01.36.64	NF.01.38.68	NF.01.38.70	NF.01.37.64	NF.01.37.115	NF.01.39.68	NF.01.39.70
supercut	NF.01.36.114	NF.01.38.118	NF.01.38.120	NF.01.37.114	NF.01.37.115	NF.01.39.118	NF.01.39.120
supercut plus	NF.01.36.164	NF.01.38.168	NF.01.38.170	NF.01.37.164	NF.01.37.215	NF.01.39.168	NF.01.39.170
black line	NF.01.36.214	NF.01.38.218	NF.01.38.220	NF.01.37.214	NF.01.37.215	NF.01.39.218	NF.01.39.220

**SCISSORS**



NELSON-METZENBAUM

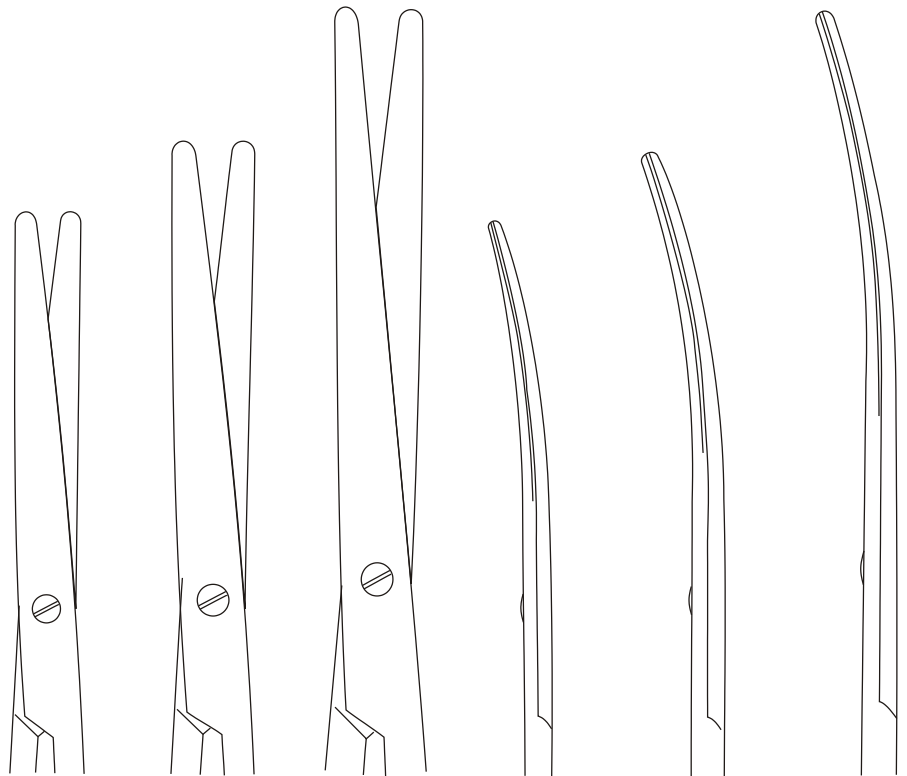

	straight 23 cm/ 9"	straight 26 cm/ 10¼"	straight 30cm/ 11¾"	curved 23 cm/ 9"	curved 26 cm/ 10¼"	curved 30cm/ 11¾"
standard	NF.01.40.23	NF.01.40.26	NF.01.40.30	NF.01.41.23	NF.01.41.26	NF.01.41.30
"TC"	NF.01.40.73	NF.01.40.76	NF.01.40.80	NF.01.41.73	NF.01.41.76	NF.01.41.80
supercut	NF.01.40.123	NF.01.40.126	NF.01.40.130	NF.01.41.123	NF.01.41.126	NF.01.41.130
supercut plus	NF.01.40.173	NF.01.40.176	NF.01.40.180	NF.01.41.173	NF.01.41.176	NF.01.41.180
black line	NF.01.40.223	NF.01.40.226	NF.01.40.230	NF.01.41.223	NF.01.41.226	NF.01.41.230



METZENBAUM-SLIM

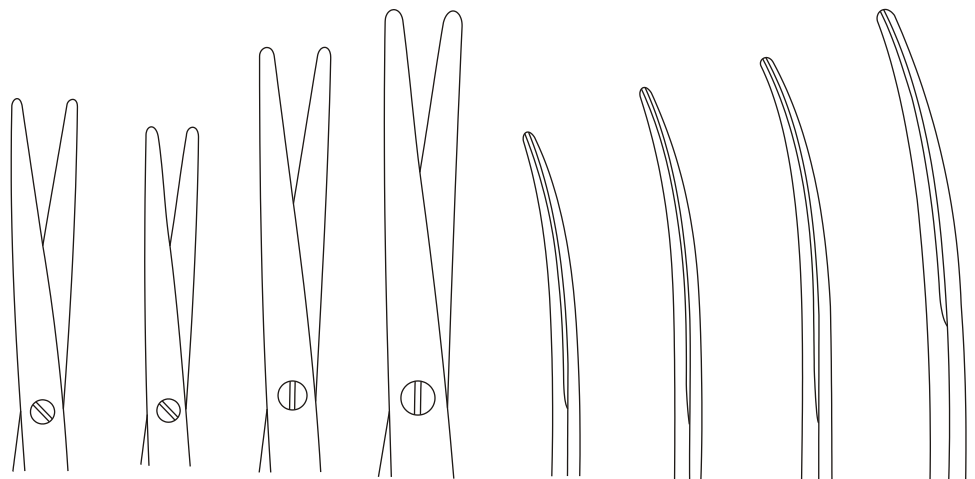

	straight 14 cm/ 5½"	straight 18 cm/ 7⅞"	straight 20cm/ 8"	straight 23 cm/ 9"	curved 14 cm/ 5½"	curved 18 cm/ 7⅞"	curved 20cm/ 8"	curved 23 cm/ 9"
standard	NF.01.42.14	NF.01.44.18	NF.01.44.20	NF.01.44.23	NF.01.43.14	NF.01.45.18	NF.01.45.20	NF.01.45.23
"TC"	NF.01.42.64	NF.01.44.68	NF.01.44.70	NF.01.44.73	NF.01.43.64	NF.01.45.68	NF.01.45.70	NF.01.45.73
supercut	NF.01.42.114	NF.01.44.118	NF.01.44.120	NF.01.44.123	NF.01.43.114	NF.01.45.118	NF.01.45.120	NF.01.45.123
supercut plus	NF.01.42.164	NF.01.44.168	NF.01.44.170	NF.01.44.173	NF.01.43.164	NF.01.45.168	NF.01.45.170	NF.01.45.173
black line	NF.01.42.214	NF.01.44.218	NF.01.44.220	NF.01.44.223	NF.01.43.214	NF.01.45.218	NF.01.45.220	NF.01.45.223



# SCISSORS

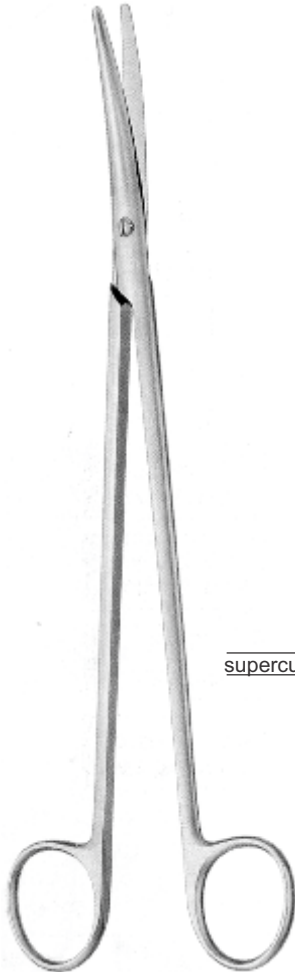

METZENBAUM-SLIM

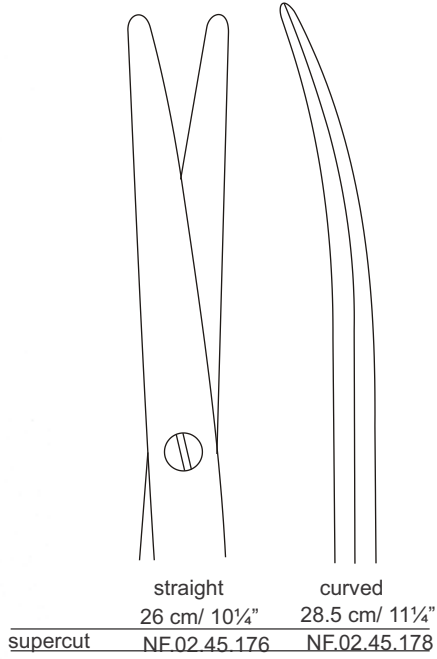

	straight	curved
	26 cm/ 10¼"	28.5 cm/ 11¼"
supercut	NF.02.45.176	NF.02.45.178



KELLY  
16 cm/ 6¼"

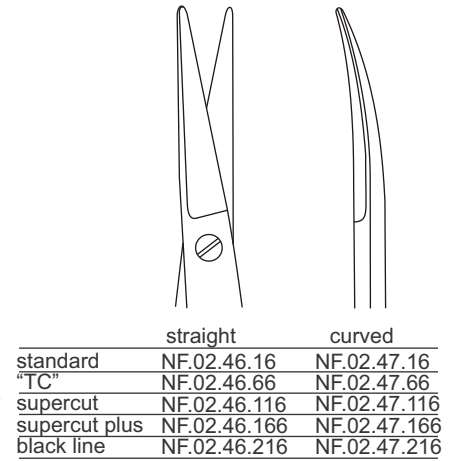

	straight	curved
standard	NF.02.46.16	NF.02.47.16
"TC"	NF.02.46.66	NF.02.47.66
supercut	NF.02.46.116	NF.02.47.116
supercut plus	NF.02.46.166	NF.02.47.166
black line	NF.02.46.216	NF.02.47.216

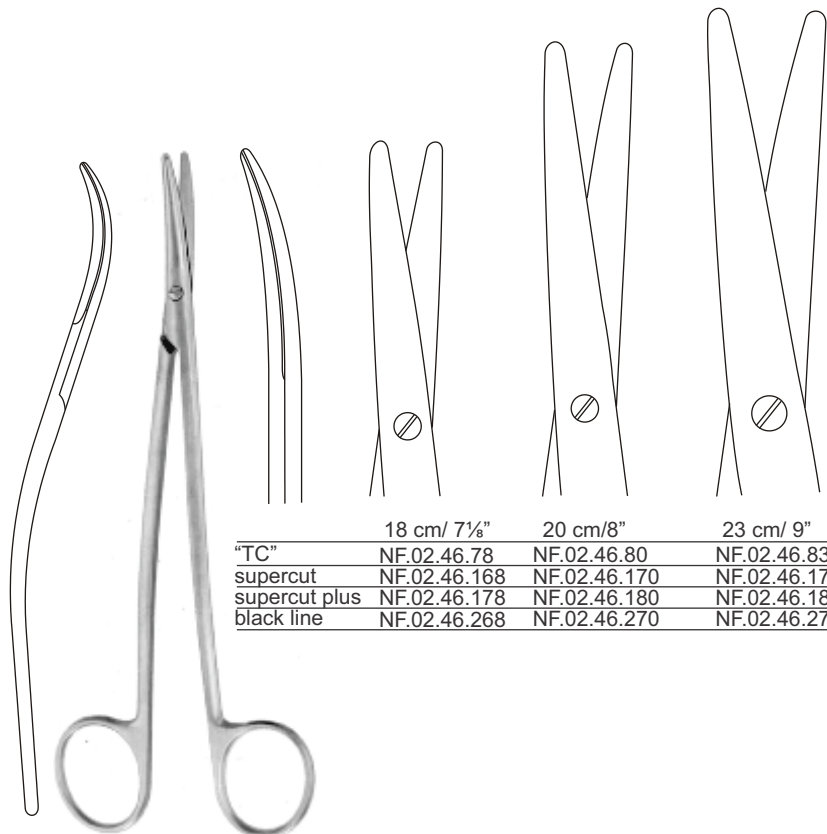

METZENBAUM

	18 cm/ 7⅞"	20 cm/ 8"	23 cm/ 9"
"TC"	NF.02.46.78	NF.02.46.80	NF.02.46.83
supercut	NF.02.46.168	NF.02.46.170	NF.02.46.173
supercut plus	NF.02.46.178	NF.02.46.180	NF.02.46.183
black line	NF.02.46.268	NF.02.46.270	NF.02.46.273

**SCISSORS**

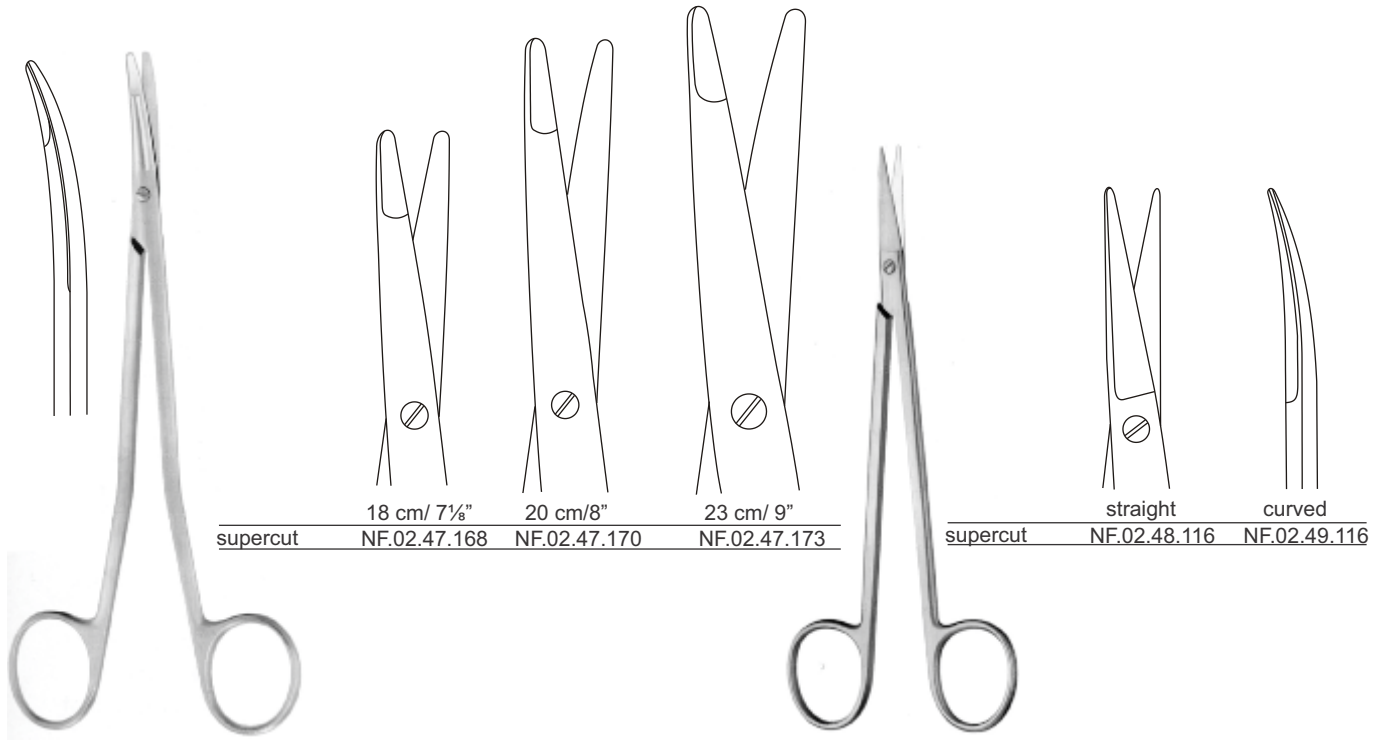

18 cm/ 7 1/8"	20 cm/8"	23 cm/ 9"
supercut	NF.02.47.168	NF.02.47.170
		NF.02.47.173

straight	curved
supercut	NF.02.48.116
	NF.02.49.116

**METZENBAUM-FREEMAN**

**BRÜSER-KELLY**

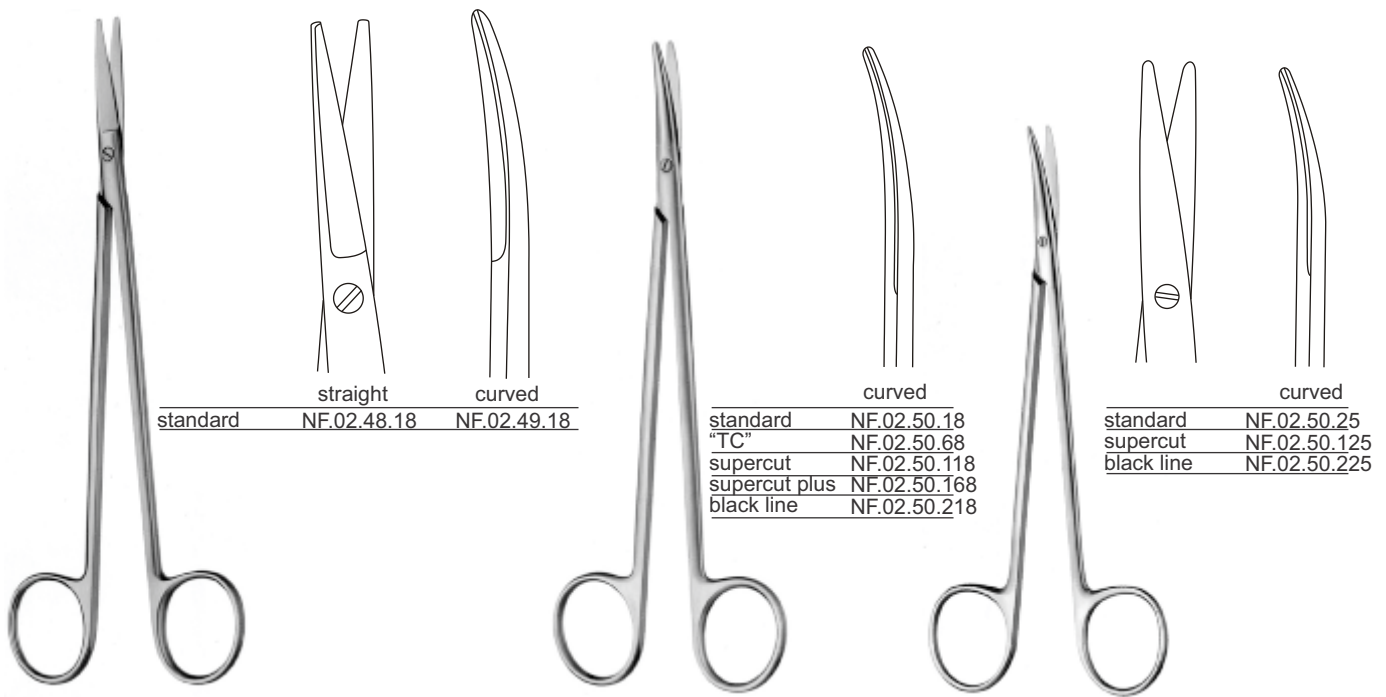

standard	straight	curved
	NF.02.48.18	NF.02.49.18

standard	curved
"TC"	NF.02.50.18
supercut	NF.02.50.68
supercut plus	NF.02.50.118
black line	NF.02.50.168
	NF.02.50.218

standard	curved
supercut	NF.02.50.25
black line	NF.02.50.125
	NF.02.50.225

**HOUSE-TOENNIS**  
18 cm/ 7 1/8"

**TOENNIS-ADSON**  
18 cm/7 1/8"

15 cm/ 6"

# SCISSORS

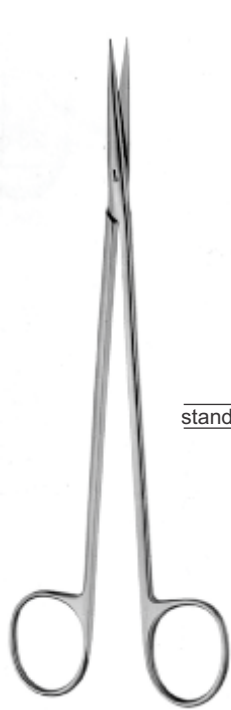

DEMARTEL  
18 cm / 7 1/8"

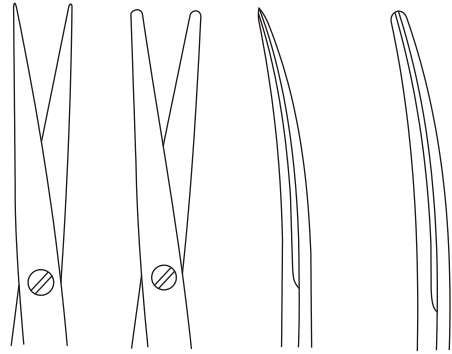

	straight	straight	curved	curved
standard	NF.02.50.78	NF.02.50.79	NF.02.51.78	NF.02.51.79

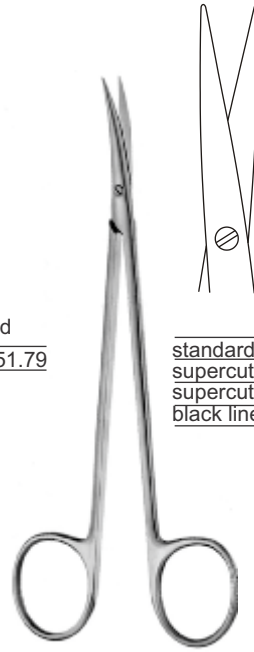

15 cm / 6"

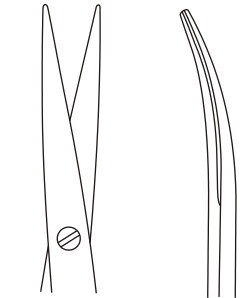

	curved
standard	NF.02.51.15
supercut	NF.02.51.115
supercut plus	NF.02.51.165
black line	NF.02.51.215

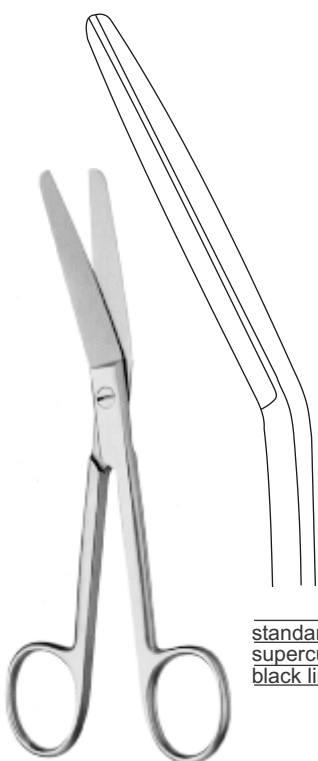

16.5 cm / 6 1/2"

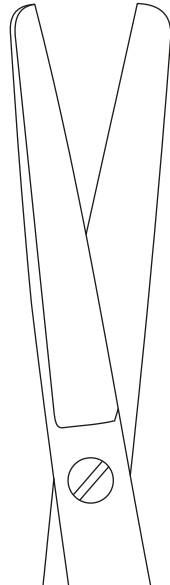

standard	NF.02.57.16
supercut	NF.02.57.116
black line	NF.02.57.216

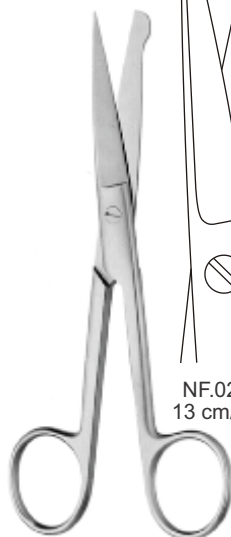

NF.02.58.13  
13 cm / 5 1/4"



NF.02.58.14  
14.5 cm / 5 3/4"

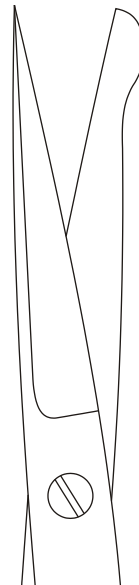

NF.02.58.16  
16.5 cm / 6 1/2"

Incision scissors

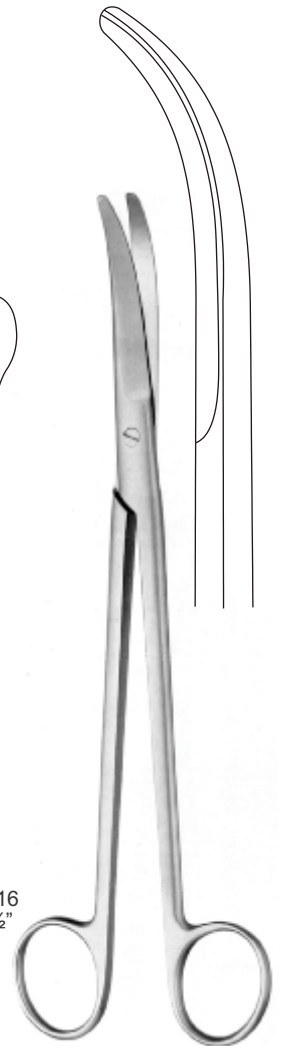

JORGENSON  
NF.02.53.93  
23 cm / 9"

**SCISSORS**

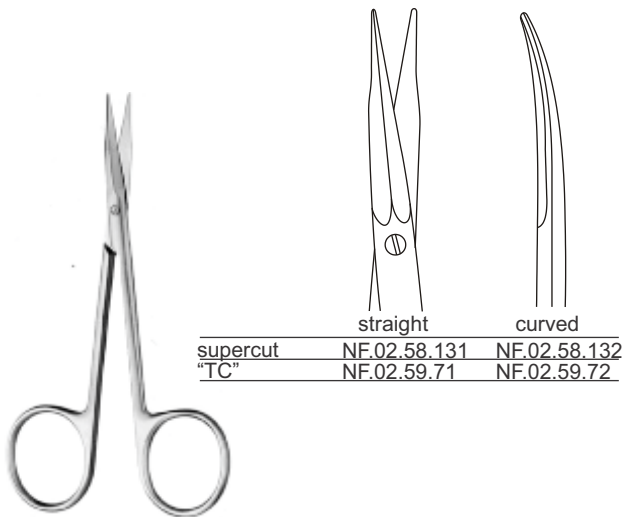

**SIEGERT**  
11.5 cm / 4½"

	straight	curved
supercut	NF.02.58.131	NF.02.58.132
"TC"	NF.02.59.71	NF.02.59.72

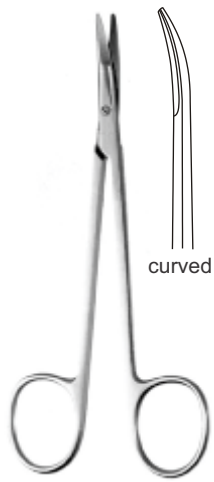

**SHEA**  
NF.02.59.12  
12 cm / 4¾"



**GREENBERG PAR**  
11.5 cm / 4½"

supercut	NF.02.60.122
supercut plus	NF.02.61.122
black line	NF.02.60.222

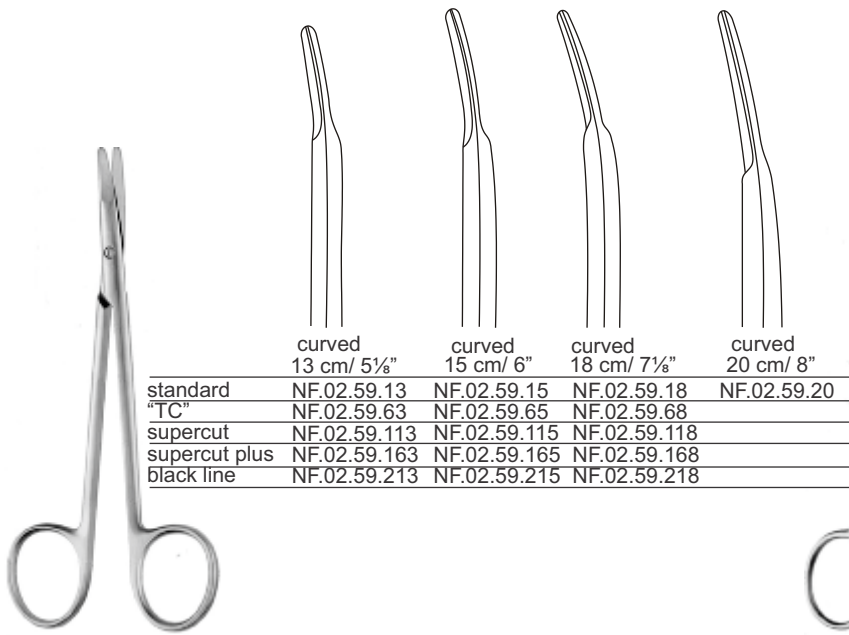

**RAGNELL (KILNER)**

	curved 13 cm / 5½"	curved 15 cm / 6"	curved 18 cm / 7½"	curved 20 cm / 8"
standard	NF.02.59.13	NF.02.59.15	NF.02.59.18	NF.02.59.20
"TC"	NF.02.59.63	NF.02.59.65	NF.02.59.68	
supercut	NF.02.59.113	NF.02.59.115	NF.02.59.118	
supercut plus	NF.02.59.163	NF.02.59.165	NF.02.59.168	
black line	NF.02.59.213	NF.02.59.215	NF.02.59.218	

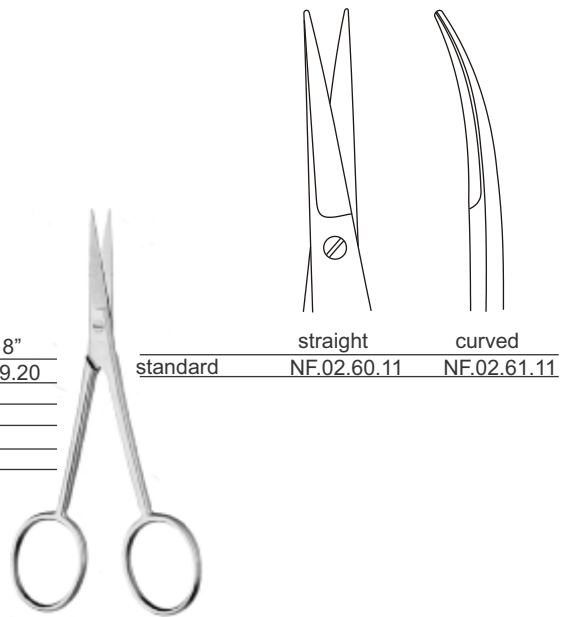

11 cm / 4¼"

	straight	curved
standard	NF.02.60.11	NF.02.61.11

# SCISSORS



**BROPHY (SULLIVAN)**  
14 cm / 5½"

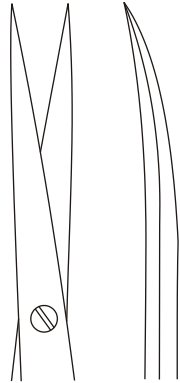

	straight	curved
standard	NF.02.61.34	NF.02.61.35

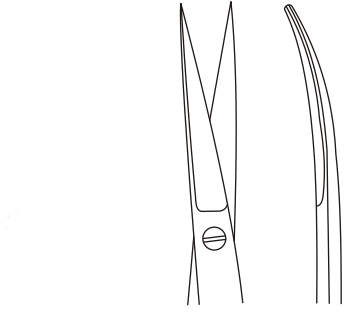
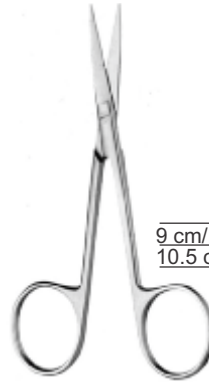

	straight	curved
9 cm / 3½"	NF.02.62.09	NF.02.63.09
10.5 cm / 4¼"	NF.02.62.10	NF.02.63.10



11 cm / 4¼"

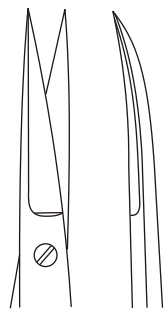

	straight	curved
standard	NF.02.64.11	NF.02.64.12
supercut	NF.02.64.111	NF.02.64.112
black line	NF.02.64.210	NF.02.64.212



**JABALEY**  
13 cm / 5⅛"

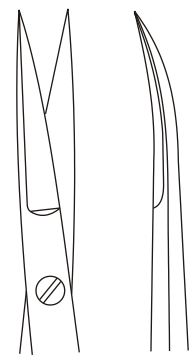

	straight	curved
standard	NF.02.64.13	NF.02.64.14
supercut	NF.02.64.113	NF.02.64.114

**SCISSORS**

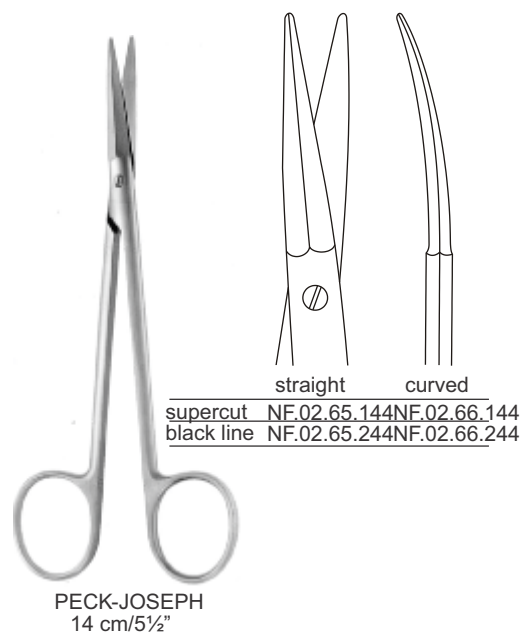
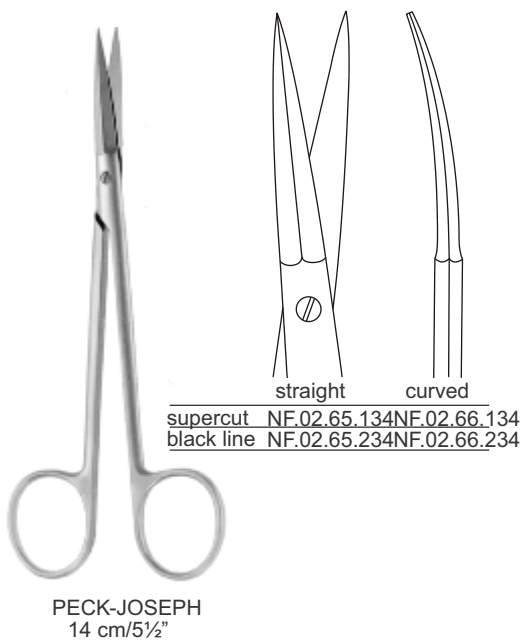
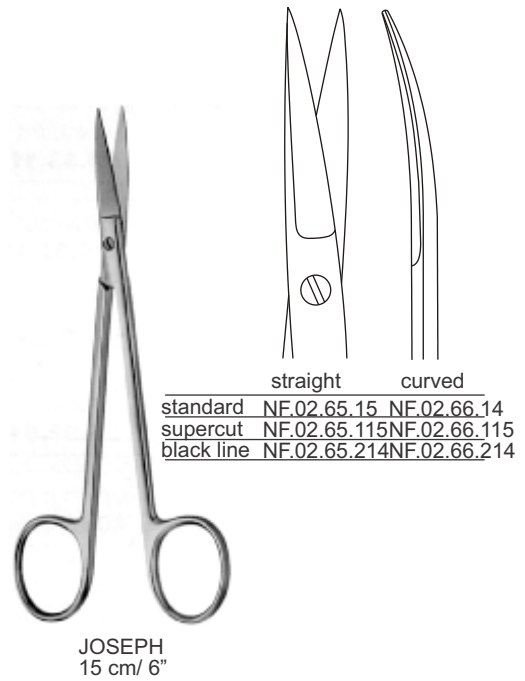
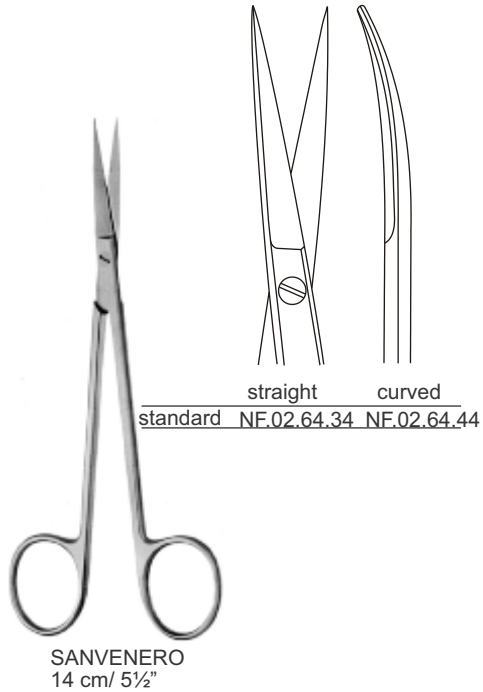

# SCISSORS



"SLIM"

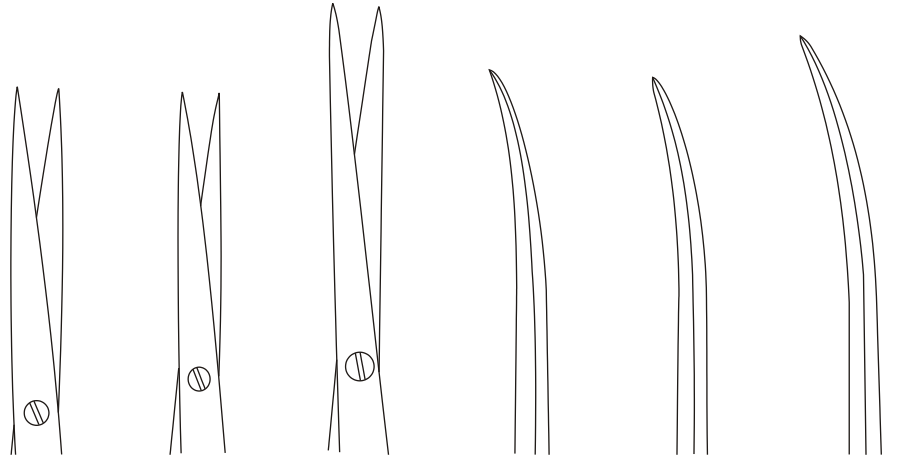

	straight 14 cm/ 5½"	straight 18 cm/ 7¼"	straight 20 cm/ 8"	curved 14 cm/5½"	curved 18 cm/ 7¼"	curved 20 cm/ 8"
standard	NF.02.67.14	NF.02.67.18	NF.02.67.20	NF.02.68.14	NF.02.68.18	NF.02.68.20
"TC"	NF.02.67.64			NF.02.68.64		
supercut	NF.02.67.114			NF.02.68.114	NF.02.68.118	
supercut plus	NF.02.67.164			NF.02.68.164		



JAMESON  
15 cm/ 6"

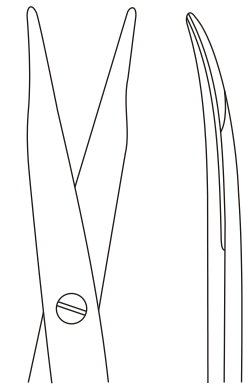

supercut	NF.02.69.117
black line	NF.02.69.217



JAMESON  
18 cm/ 7¼"



supercut	NF.02.70.118
black line	NF.02.70.218

**SCISSORS**



REYNOLDS (JAMESON)

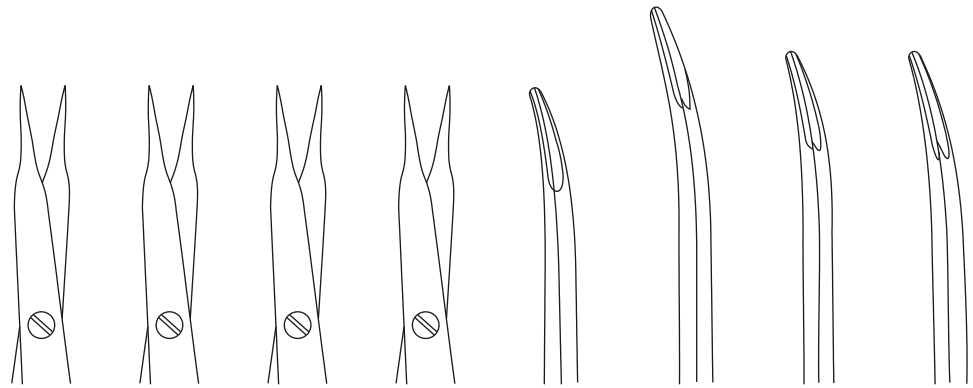

	12 cm/ 4½"	14 cm/ 5½"	16 cm/ 6¼"	18 cm/ 7⅞"	12 cm/ 4½"	14 cm/ 5½"	16 cm/ 6¼"	18 cm/ 7⅞"
standard	NF.02.72.12	NF.02.72.14	NF.02.72.16	NF.02.72.18	NF.02.73.12	NF.02.73.14	NF.02.73.16	NF.02.73.18
supercut					NF.02.73.112		NF.02.73.116	NF.02.73.118
black line					NF.02.73.212		NF.02.73.216	NF.02.73.218

flat tips



FANOUS

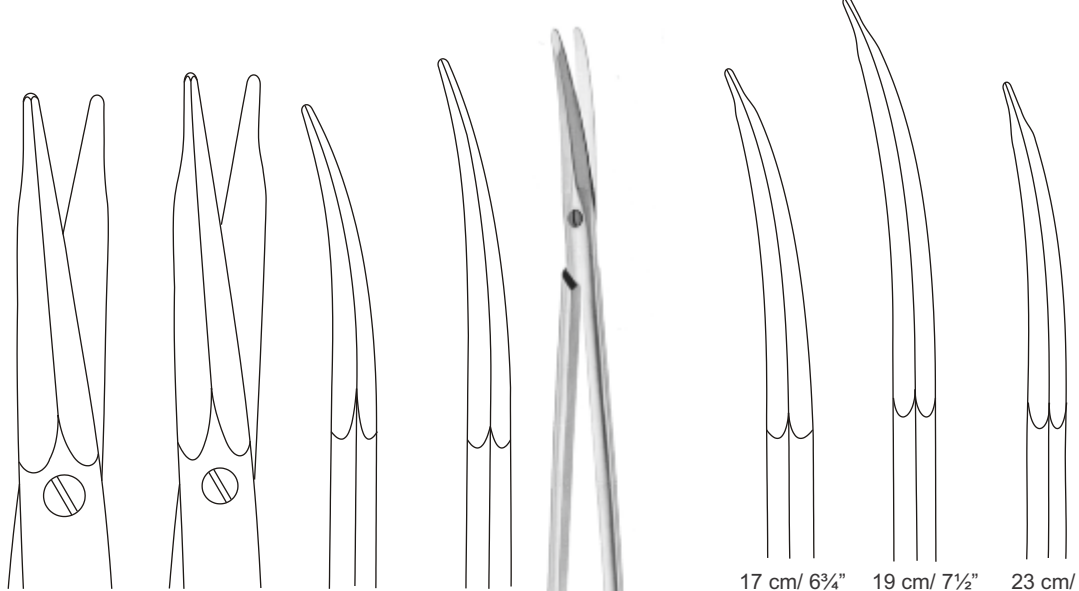

	16.5 cm/ 6½"	20.5 cm/ 8"	16.5 cm/ 6½"	20.5 cm/ 8"	17 cm/ 6¾"	19 cm/ 7½"	23 cm/ 9"
supercut	NF.02.74.116	NF.02.74.120	NF.02.74.126	NF.02.74.130	NF.02.77.127	NF.02.77.129	NF.02.77.133
"TC"					NF.02.77.67	NF.02.77.69	NF.02.77.73
black line					NF.02.77.227	NF.02.77.229	NF.02.77.233

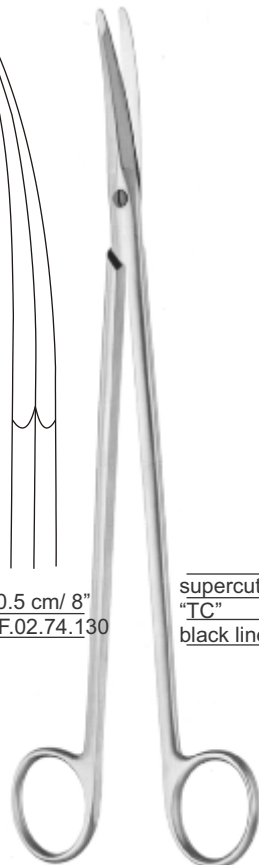

GORNEY  
FACE LIFT



# SCISSORS

flat tips

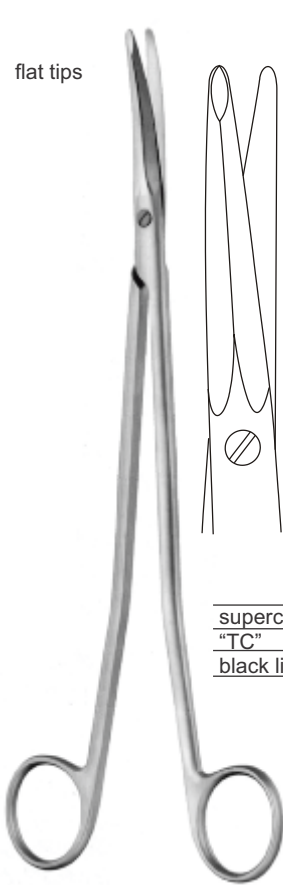

**GORNEY-FREEMAN  
FACE LIFT**

	17 cm/ 6¾"	19 cm/ 7½"	23 cm/ 9"
supercut	NF.02.80.117	NF.02.80.119	NF.02.80.123
"TC"	NF.02.80.37	NF.02.80.39	NF.02.80.43
black line	NF.02.80.217	NF.02.80.219	NF.02.80.223

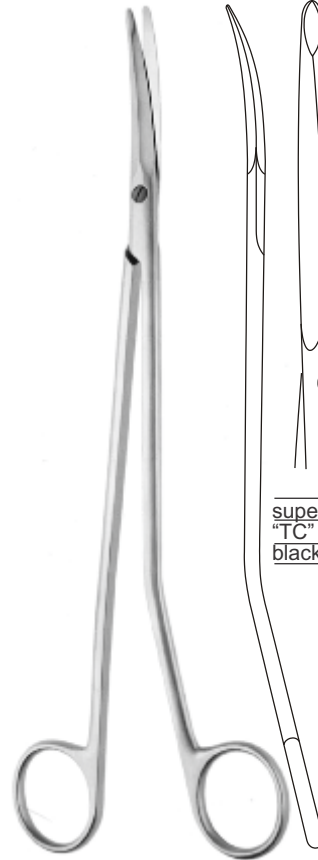

**GORNEY-FREEMAN  
23 cm/ 9"**

supercut	NF.02.80.152
"TC"	NF.02.80.72
black line	NF.02.82.252

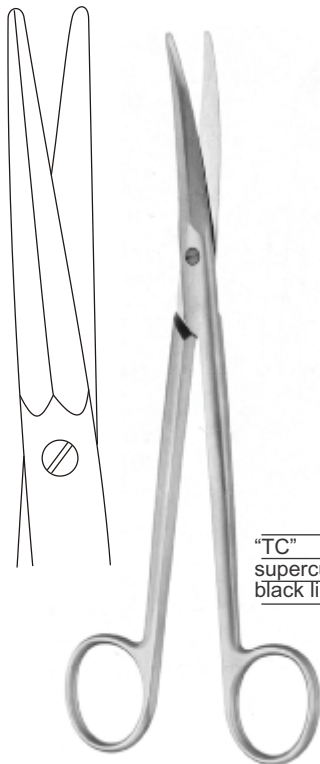

**KAYE  
FACE LIFT**

	15 cm/ 6"	17 cm/ 6¾"	19 cm/ 7½"	23 cm/ 9"
"TC"		NF.02.81.37	NF.02.81.39	NF.02.81.43
supercut	NF.02.81.115	NF.02.81.117	NF.02.81.119	NF.02.81.123
black line	NF.02.81.215	NF.02.81.217	NF.02.81.219	NF.02.81.223



**KAYE  
11.5 cm/ 4½"**

supercut	NF.02.81.132
black line	NF.02.81.232

**SCISSORS**

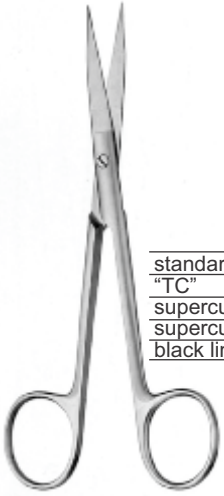

	straight	curved
standard	NF.02.90.13	NF.02.91.13
"TC"	NF.02.90.63	NF.02.91.63
supercut	NF.02.90.113	NF.02.91.113
supercut plus	NF.02.90.163	NF.02.91.163
black line	NF.02.90.213	NF.02.91.213

**FOX**  
13 cm / 5 1/8"

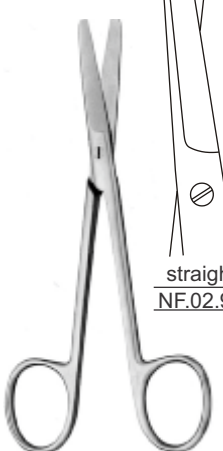

	straight	curved
	NF.02.95.02	NF.02.96.02

**WAGNER**  
12 cm / 4 3/4"

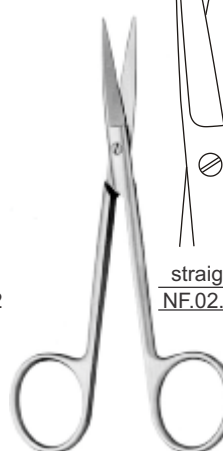

	straight	curved
	NF.02.95.12	NF.02.96.12

**WAGNER**  
12 cm / 4 3/4"

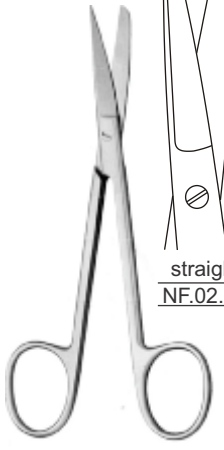

	straight	curved
	NF.02.95.32	NF.02.96.32

**WAGNER**  
12 cm / 4 3/4"

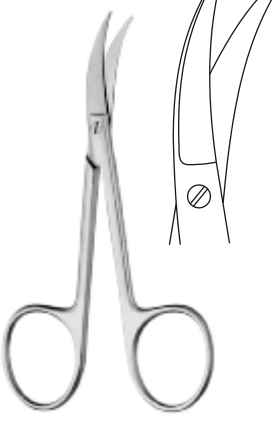

	straight	curved
	NF.02.96.80	NF.02.96.80

**NF.02.96.80**  
10.5cm / 4 1/8"



	straight	curved
	NF.02.110.13	NF.02.111.13

**QUIMBY**  
13 cm / 5 1/8"

# SCISSORS

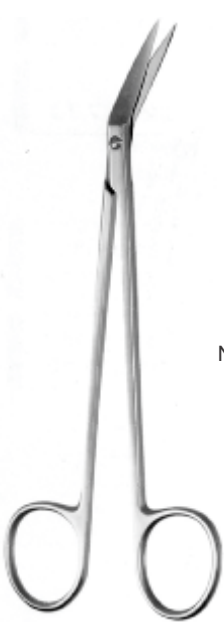

LOCKLIN  
16 cm/ 6¼"

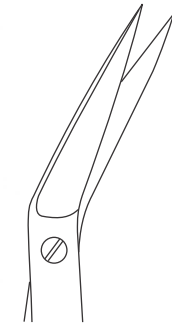

NF.02.115.15

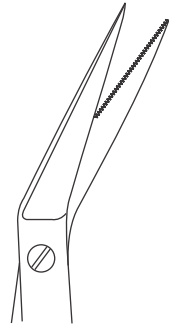

NF.02.115.16

serrated cutting edges



LOCKLIN  
16 cm/ 6¼"

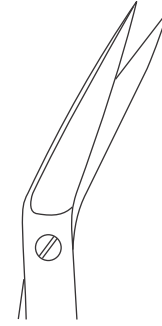

NF.02.116.26

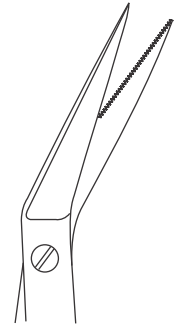

NF.02.116.27

serrated cutting edges



12 cm/ 4¾"

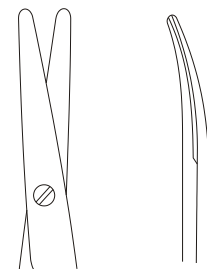

standard	NF.02.196.42	NF.02.196.43
"TC"	NF.02.196.62	NF.02.196.63
supercut	NF.02.196.142	NF.02.196.143
supercut plus	NF.02.196.162	NF.02.196.163

# Micro Scissors



# Micro Scissors



MICRO 2000  
15 cm / 6"



NF.02.01.20  
standard

NF.02.01.120  
supercut



NF.02.01.21  
standard

NF.02.01.121  
supercut



NF.02.01.22  
standard

serrated cutting edges



NF.02.01.23  
standard



NF.02.01.30  
standard

Vannas-type cutting edges

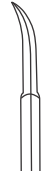

NF.02.01.31  
standard



NF.02.02.20  
standard



NF.02.02.21  
standard

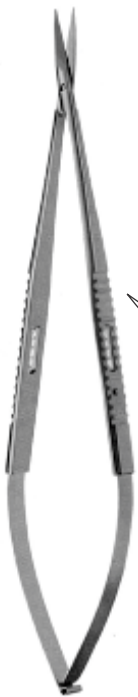

JACOBSON  
MICRO 2000  
18 cm / 7½"



NF.02.07.20



NF.02.07.25



NF.02.07.21

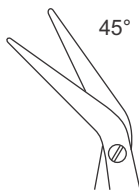

NF.02.07.26



MICRO 2000  
12.5 cm / 5"



NF.02.03.22  
standard

serrated cutting edges



NF.02.03.23  
standard



NF.02.04.30  
standard

Vannas-type cutting edges



NF.02.04.31  
standard

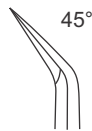

NF.02.05.25  
standard



NF.02.05.28  
standard



NF.02.06.29  
standard

# Micro Scissors



Vannas-type cutting edges

**KOSHIMA**  
NF.02.06.34  
15 cm / 6"



**KOSHIMA**  
NF.02.06.32  
15 cm / 6"



**YASARGIL**  
12 cm / 4 3/4"



NF.02.05.40



NF.02.05.41

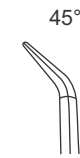

NF.02.05.55



NF.02.05.50



NF.02.05.51

Vannas-type cutting edges



**YASARGIL**  
15 cm / 6"



NF.02.01.40



NF.02.01.41



NF.02.01.50

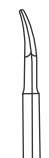

NF.02.01.51

Vannas-type cutting edges



12 cm / 4 3/4"



NF.02.08.84



NF.02.08.85



NF.02.08.88

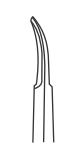

NF.02.08.87



NF.02.08.89

Vannas-type cutting edges

# Micro Scissors

Vein scissors



**BIEMER**  
NF.02.08.90  
13 cm / 5 1/8"

16 cm / 6 1/4"

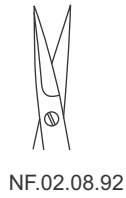

NF.02.08.92

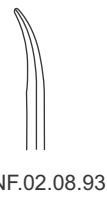

NF.02.08.93

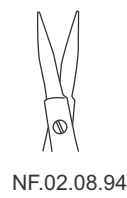

NF.02.08.94

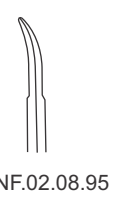

NF.02.08.95

Vannas-type cutting edges

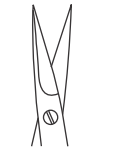

NF.02.08.96

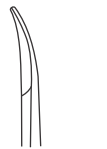

NF.02.08.97

**MILLES**  
serrated cutting edges



**YASARGIL**  
NF.02.08.98

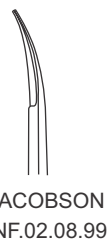

**JACOBSON**  
NF.02.08.99

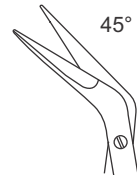

**POTTS-YASARGIL**  
NF.02.09.01

18.5 cm / 7 1/4"



NF.02.09.10  
18.5 cm / 7 1/4"

# Micro Scissors



15 cm/ 6"  
Round handle Ø 8 mm



NF.02.01.74  
standard



NF.02.01.75  
standard



NF.02.01.76  
standard



NF.02.01.77  
standard

Vannas-type cutting edges

NF.02.01.174  
supercut

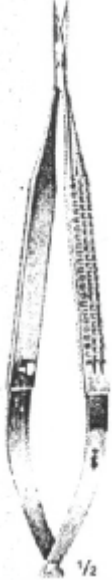

MICRO SCISSORS  
NF.02.12.12  
12 cm/ 4¾"

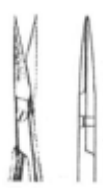

MICRO SCISSORS  
NF.02.13.12  
12 cm/ 4¾"



NF.02.08.02  
23 cm/ 9"  
Round Handle Ø 8 mm



# Scalpels, Knives



# Scalpels, Knives



13 cm/ 5 1/8"



NF.02.01.01  
# 1



NF.02.01.02  
# 2



NF.02.01.03  
# 3



NF.02.01.04  
# 4



NF.02.01.07  
# 7



NF.02.01.08  
# 8



NF.02.01.09  
# 9

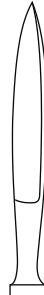

NF.02.01.10  
# 10



**PARKER**  
14 cm/ 5 1/2"



NF.02.02.07  
# 1



NF.02.02.09  
# 2



**ADAMS**  
15 cm/ 6"



NF.02.13.51  
# 1



NF.02.13.52  
# 2



NF.02.13.53  
# 3



NF.02.13.54  
# 4

# Scalpels, Knives



NF.02.03.10  
# 10



NF.02.03.11  
# 11



NF.02.03.12  
# 12



NF.02.03.13  
# 12d



NF.02.03.15  
# 15



NF.02.03.18  
# 18



NF.02.03.19  
# 19



NF.02.03.20  
# 20



NF.02.03.21  
# 12d



NF.02.03.22  
# 22



NF.02.03.23  
# 23

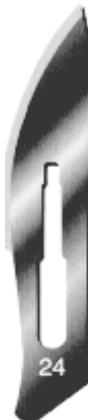

NF.02.03.24  
# 24



NF.02.03.25  
# 25

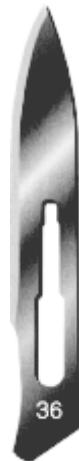

NF.02.03.36  
# 36

# Scalpels, Knives



BARRON  
NF.02.10.84  
13 cm / 5 1/8"



NF.02.04.03  
# 3  
12.5 cm / 5"



NF.02.04.04  
# 3  
12.5 cm / 5"



NF.02.05.07  
# 7  
16.5 cm / 6 1/2"



NF.02.06.17  
# 7K  
12 cm / 4 3/4"



NF.02.07.13  
# 3L  
21 cm / 8 1/4"



NF.02.08.23  
# 3LA  
20.5 cm / 8"

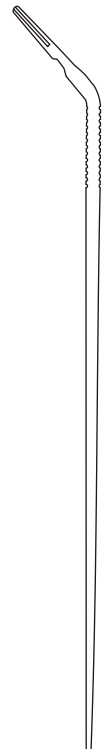

NF.02.09.04  
# 4  
13.5 cm / 5 3/8"



NF.02.10.40  
15.5 cm / 6 1/8"



NF.02.10.22  
22.5 cm / 9"



NF.02.10.90  
13 cm / 5 1/8"



NF.02.10.91  
15.5 cm / 6 1/8"

# Scalpels, Knives



NF.02.10.45  
22.5 cm/ 9"



NF.02.10.53  
27 cm/ 10 3/4"



NF.02.10.61  
21 cm/ 8 1/4"



NF.02.10.63  
15.5 cm/ 6 1/4"



NF.02.10.64  
# 4L  
21 cm/ 8 1/4"

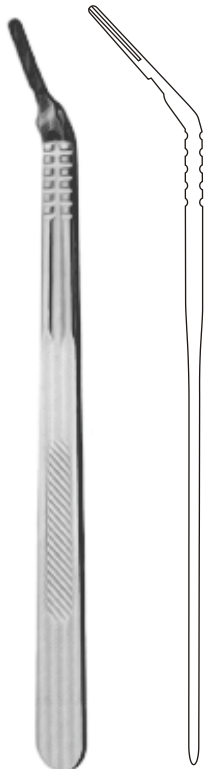

NF.02.10.74  
# 4LA  
20.5 cm/ 8 1/8"



LANDOLT  
NF.02.10.86  
21 cm/ 8 1/4"



LANDOLT  
NF.02.10.87  
25 cm/ 10"

# Scalpels, Knives



1/1

NF.02.10.92  
# 62



1/1

NF.02.10.94  
# 64



1/1

NF.02.10.95  
# 65



1/1

NF.02.10.97  
# 67



13.5 cm/ 5¼"



NF.02.11.01  
# 1



NF.02.11.02  
# 2

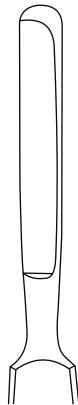

NF.02.11.03  
# 3

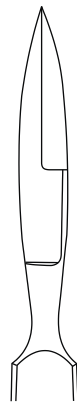

NF.02.11.04  
# 4



COLLIN  
16 cm/ 6¼"



NF.02.12.01  
# 1



NF.02.12.02  
# 2



NF.02.12.03  
# 3



NF.02.12.04  
# 4



NF.02.12.05  
# 5



NF.02.12.06  
# 6

# Scalpels, Knives

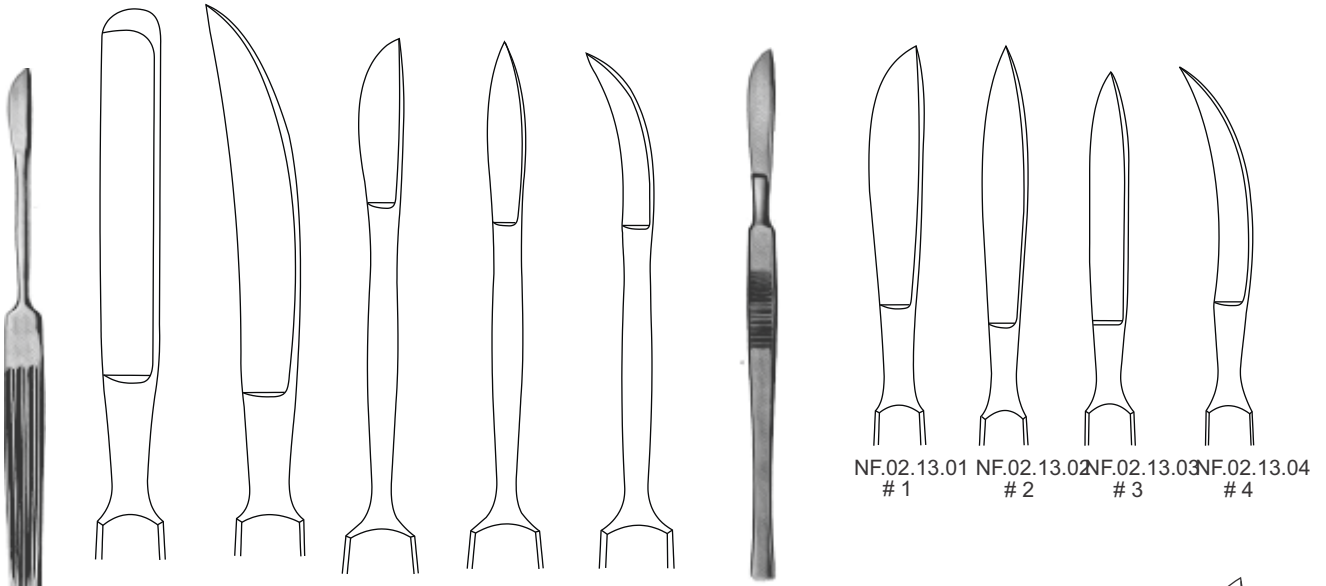

NF.02.12.38 # 38    NF.02.12.64 # 44    NF.02.12.61 # 61    NF.02.12.61 # 62    NF.02.12.62 # 62    NF.02.12.63 # 63    BERGMANN 14 cm / 5½"

NF.02.13.01 # 1    NF.02.13.02 # 2    NF.02.13.03 # 3    NF.02.13.04 # 4

17 cm / 6¾"



16 cm / 6¼"

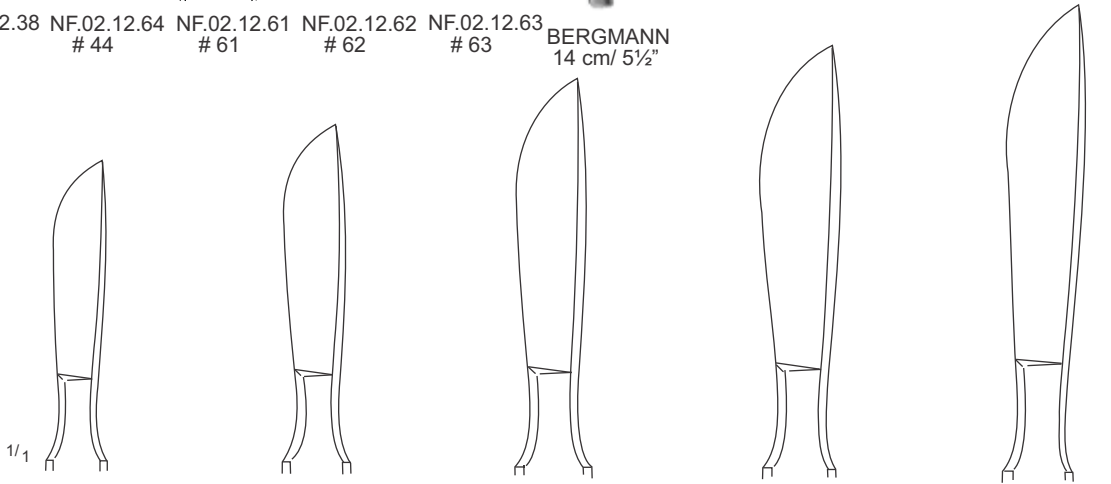

NF.02.12.41 Fig. 1    NF.02.12.42 Fig. 2    NF.02.12.43 Fig. 3    NF.02.12.44 Fig. 4    NF.02.12.45 Fig. 5

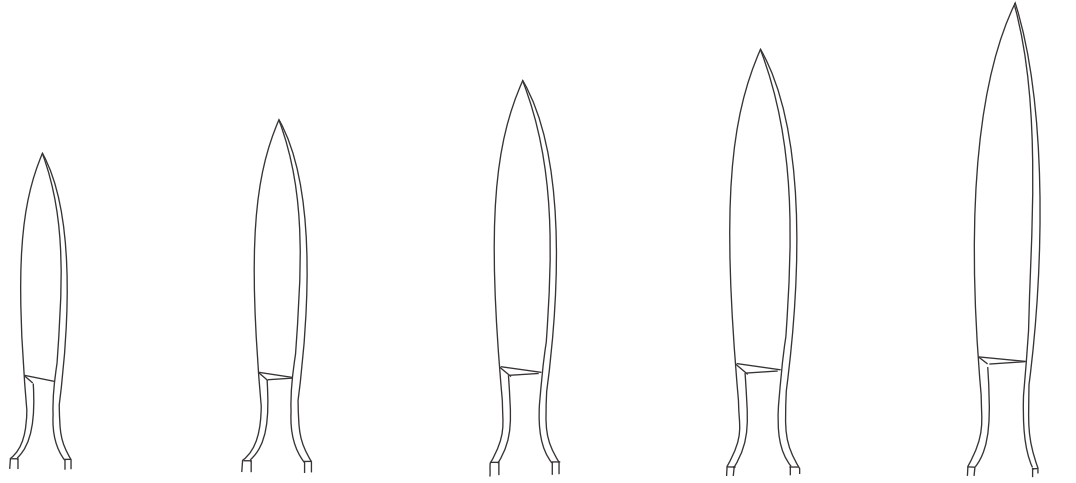

NF.02.12.46 Fig. 6    NF.02.12.47 Fig. 7    NF.02.12.48 Fig. 8    NF.02.12.49 Fig. 9    NF.02.12.50 Fig. 10

# Scalpels, Knives



17 cm/ 6¾"

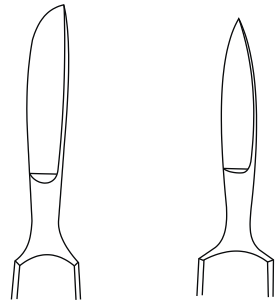

- |                 |                  |
|-----------------|------------------|
| NF.02.13.11 # 1 | NF.02.13.20 # 10 |
| NF.02.13.12 # 2 | NF.02.13.21 # 11 |
| NF.02.13.13 # 3 | NF.02.13.22 # 12 |
| NF.02.13.15 # 5 | NF.02.13.23 # 13 |
| NF.02.13.17 # 7 | NF.02.13.25 # 15 |
| NF.02.13.19 # 9 | NF.02.13.26 # 16 |

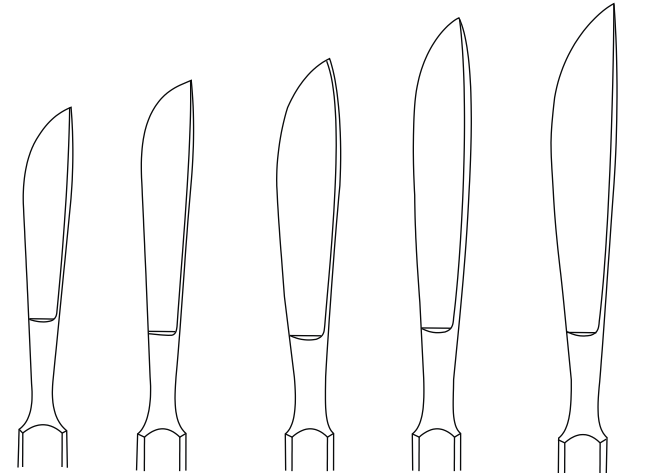

- |                 |                 |                 |                 |                 |
|-----------------|-----------------|-----------------|-----------------|-----------------|
| NF.02.13.31 # 1 | NF.02.13.32 # 2 | NF.02.13.33 # 3 | NF.02.13.34 # 4 | NF.02.13.35 # 5 |
|-----------------|-----------------|-----------------|-----------------|-----------------|



DIEFFENBACH  
16 cm/ 6¼"

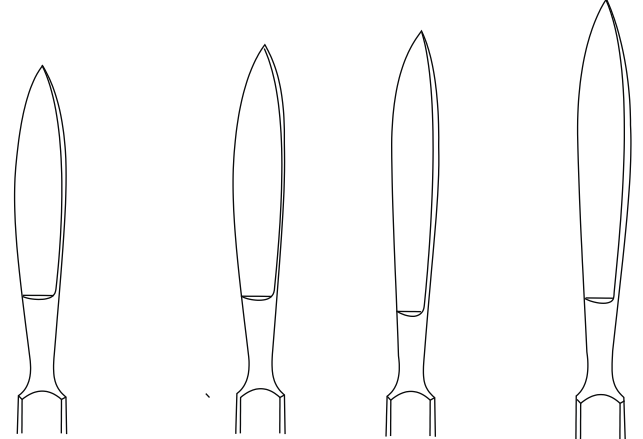

- |                 |                 |                 |                 |
|-----------------|-----------------|-----------------|-----------------|
| NF.02.13.36 # 6 | NF.02.13.37 # 7 | NF.02.13.38 # 8 | NF.02.13.39 # 9 |
|-----------------|-----------------|-----------------|-----------------|

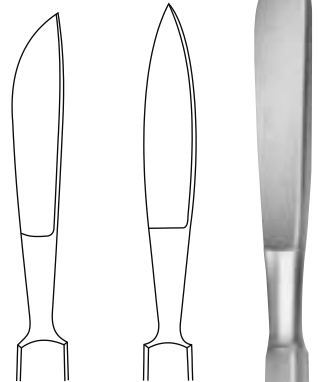

- |             |             |             |
|-------------|-------------|-------------|
| NF.02.13.71 | NF.02.13.72 | NF.02.13.73 |
|-------------|-------------|-------------|



SIMON  
20 cm/ 8"



# Scalpels, Knives

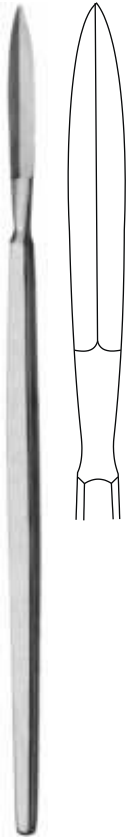

SCHROEDER  
NF.02.13.82  
22 cm / 8¾"

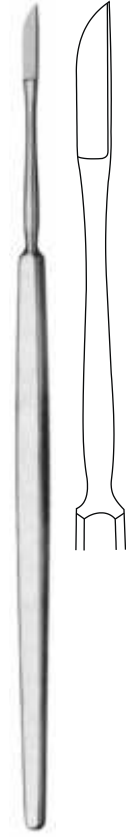

ULRICH  
NF.02.13.83  
22 cm / 8¾"



SIMON  
NF.02.13.92  
22 cm / 8¾"



COLLIN  
NF.02.16.15  
27 cm / 10¾"



CATLIN



NF.02.14.16  
29 cm / 11½"



NF.02.14.22  
35 cm / 13¾"



NF.02.15.11  
23 cm / 9"



11 cm



15 cm

# Scalpels, Knives

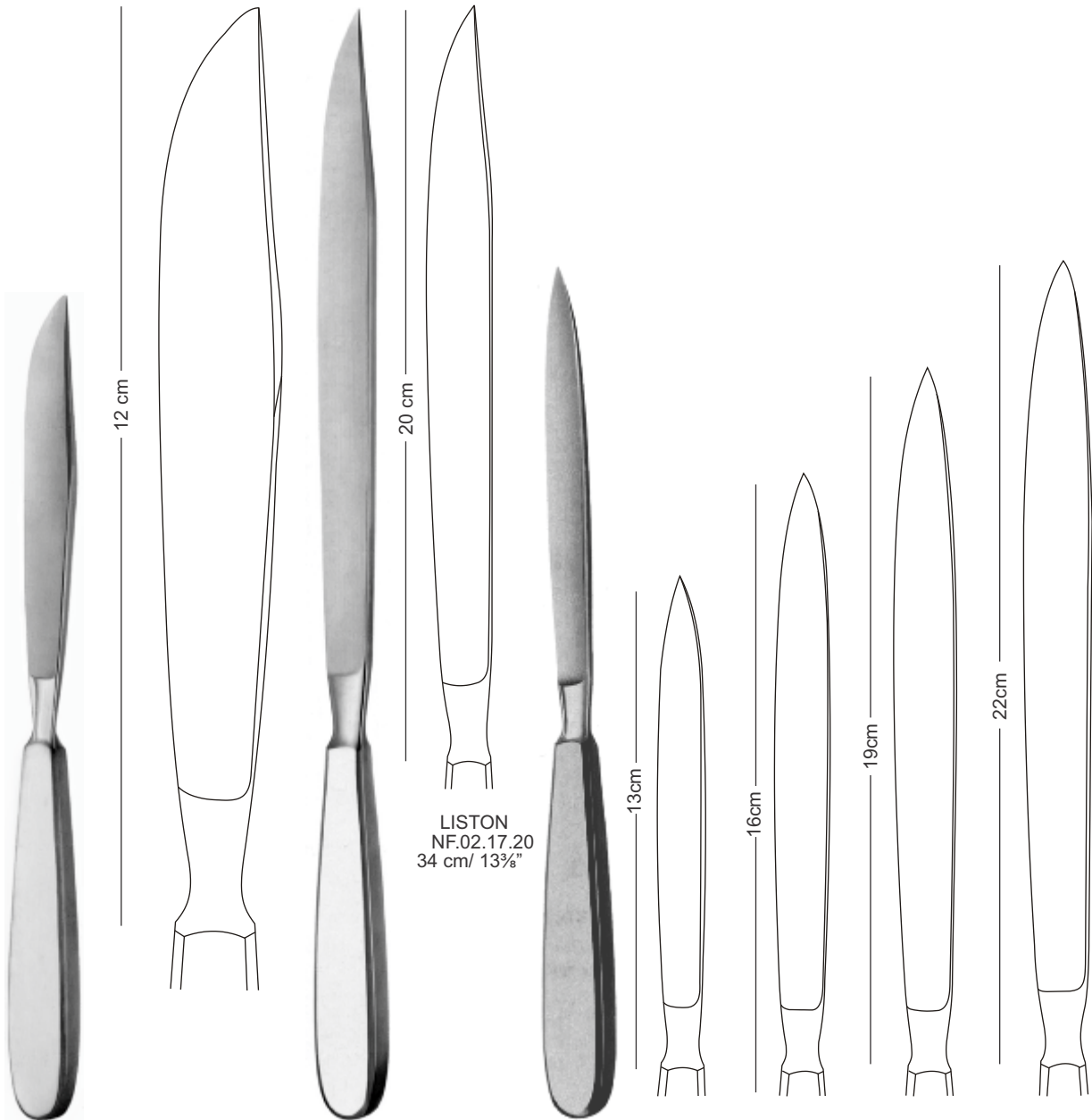

**LANGENBECK**  
NF.02.17.12  
24 cm / 9½"

**LISTON**  
NF.02.17.20  
34 cm / 13¾"

NF.02.17.26 26 cm / 10¼"    NF.02.17.29 29 cm / 11⅝"    NF.02.17.32 32 cm / 12½"    NF.02.17.35 35 cm / 13¾"

# Scalpels, Knives



**LISTON**  
NF.02.18.10  
23 cm/ 9"



**LANGENBECK**  
18 cm/ 7 1/8"



NF.02.19.01  
#1



NF.02.19.02  
#2



**VIRCHOW**  
NF.02.25.16 – 29 cm/ 11"  
NF.02.25.20 – 33 cm/ 13"  
NF.02.25.24 – 37 cm/ 14 1/2"



**VAUGHN**  
NF.02.30.12  
12.5 cm/ 5"

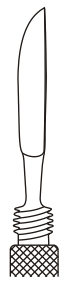

NF.02.31.13  
13 cm/ 5 1/8"



# Scalpels, Knives



HUMBY  
NF.02.30.30  
32 cm / 12½"  
Skin graft knife,  
without blades

Spare blade  
NF.02.30.31



WATSON  
NF.02.30.32  
30.5 cm / 12"  
Skin graft knife,  
without blades

# Dressing and Tissue Forceps



# Dressing and Tissue Forceps

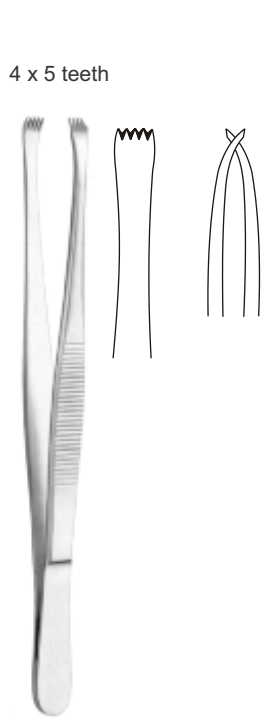

**STONE**  
NF.02.11.15  
15 cm/ 6"

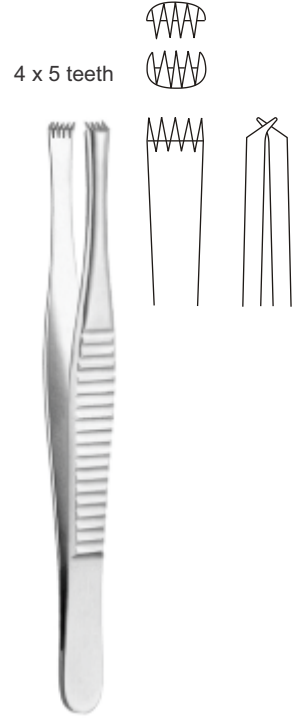

**BEESON**  
NF.02.11.16  
16 cm/ 6¼"

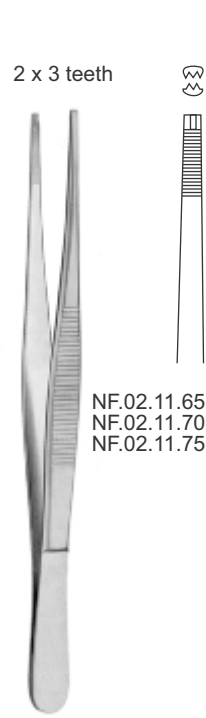

**ADLERKREUTZ**

- NF.02.11.65 15 cm/ 6"
- NF.02.11.70 20 cm/ 8"
- NF.02.11.75 25 cm/ 10"

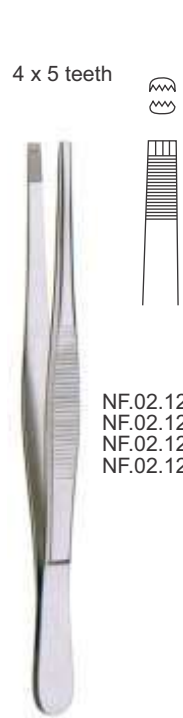

**ADLERKREUTZ**

- NF.02.12.63 13 cm/ 5½"
- NF.02.12.65 15 cm/ 6"
- NF.02.12.70 20 cm/ 8"
- NF.02.12.75 25 cm/ 10"



**STILLE-BARRAYA**

- NF.02.13.18 18 cm/ 7½"
- NF.02.13.20 20 cm/ 8"
- NF.02.13.25 25 cm/ 10"



**ADSON**  
NF.02.15.12  
12 cm/ 4¾"



**ADSON "TC"**  
NF.02.15.62  
12 cm/ 4¾"



**ADSON "TC"**  
NF.02.15.65  
15 cm/ 6"

# Dressing and Tissue Forceps

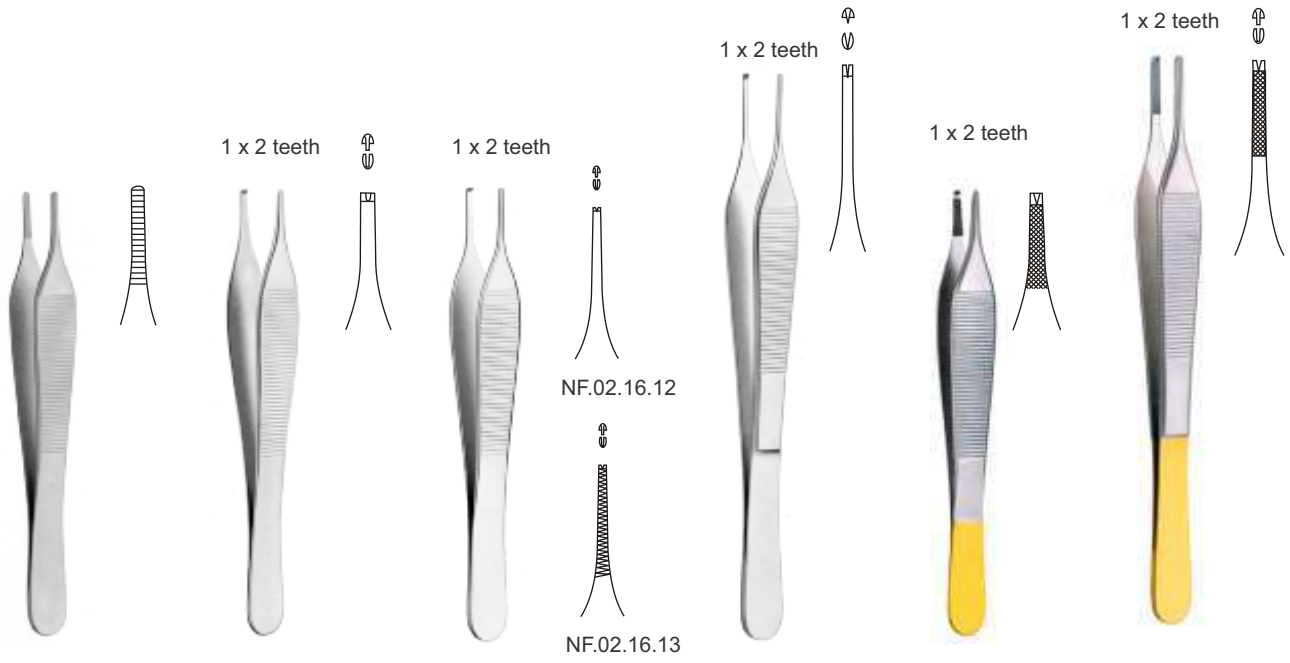

HUDSON-EWALD NF.02.16.01 12 cm / 4¾"  
 HUDSON-EWALD NF.02.16.05 12 cm / 4¾"  
 ADSON NF.02.16.12 12 cm / 4¾"  
 ADSON NF.02.16.13 12 cm / 4¾"  
 ADSON NF.02.16.15 15 cm / 6"  
 ADSON "TC" NF.02.16.62 12 cm / 4¾"  
 ADSON "TC" NF.02.16.65 15 cm / 6"

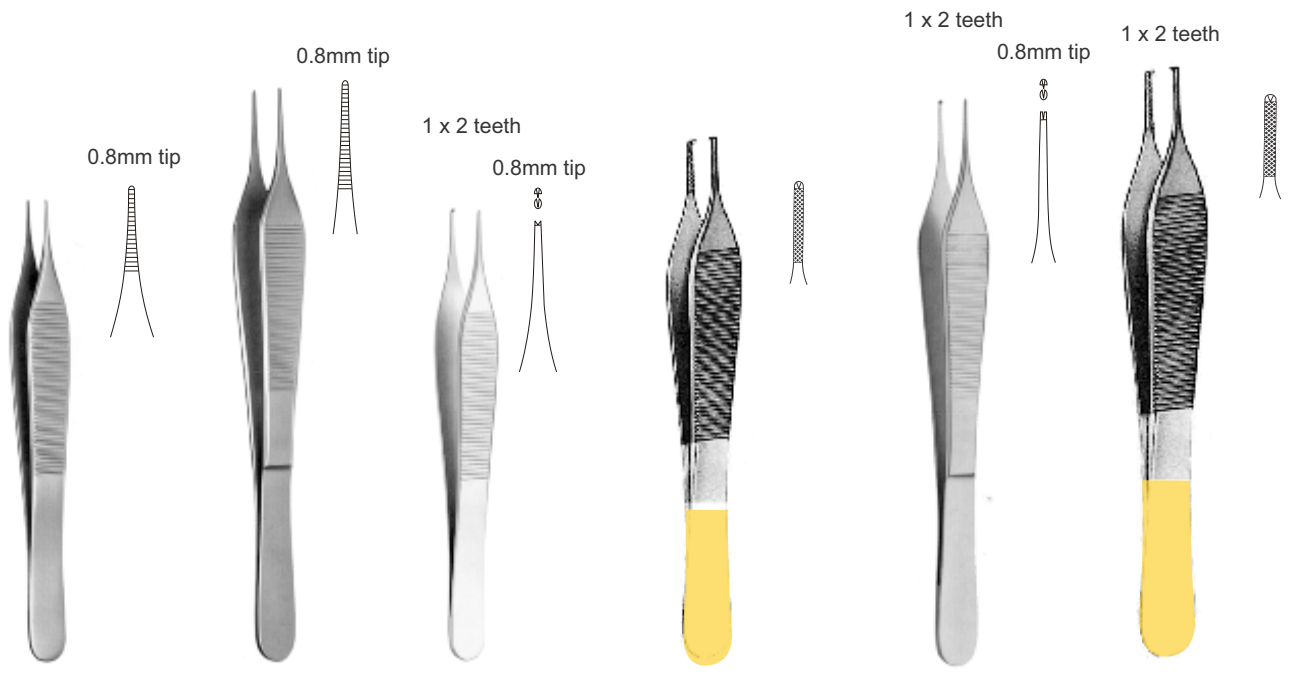











MICRO-ADSON NF.02.17.12 12 cm / 4¾"  
 MICRO-ADSON NF.02.18.15 15 cm / 6"  
 MICRO-ADSON NF.02.19.12 12 cm / 4¾"  
 MICRO-ADSON "TC" NF.02.19.62 12 cm / 4¾"  
 MICRO-ADSON NF.02.20.15 15 cm / 6"  
 MICRO-ADSON "TC" NF.02.20.65 15 cm / 6"

# Dressing and Tissue Forceps







Standard

-   
 NF.02.01.09  
9 cm / 3½"
-   
 NF.02.01.10  
10.5 cm / 4⅙"
-   
 NF.02.01.11  
11.5 cm / 4½"
-   
 NF.02.01.13  
13 cm / 5⅙"
-   
 NF.02.01.14  
14.5 cm / 5¾"
-   
 NF.02.01.15  
15 cm / 6"
-   
 NF.02.01.16  
16 cm / 6¼"
-   
 NF.02.01.18  
18 cm / 7⅙"

-   
 NF.02.01.20  
20 cm / 8"
-   
 NF.02.01.25  
25 cm / 10"
-   
 NF.02.01.30  
30 cm / 11¼"









"TC"

-   
 NF.02.01.64  
14.5 cm / 5¾"
-   
 NF.02.01.70  
20 cm / 8"
-   
 NF.02.01.68  
18 cm / 7⅙"
-   
 NF.02.01.75  
25 cm / 10"

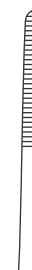
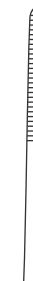

medium width

-   
 NF.02.02.10  
10.5 cm / 4⅙"
-   
 NF.02.02.11  
11.5 cm / 4½"
-   
 NF.02.02.13  
13 cm / 5"
-   
 NF.02.02.14  
14.5 cm / 5¾"
-   
 NF.02.02.16  
16 cm / 6¼"
-   
 NF.02.02.18  
18 cm / 7⅙"
-   
 NF.02.02.20  
20 cm / 8"
-   
 NF.02.02.25  
25 cm / 10"
-   
 NF.02.02.30  
30 cm / 11¼"



# Dressing and Tissue Forceps

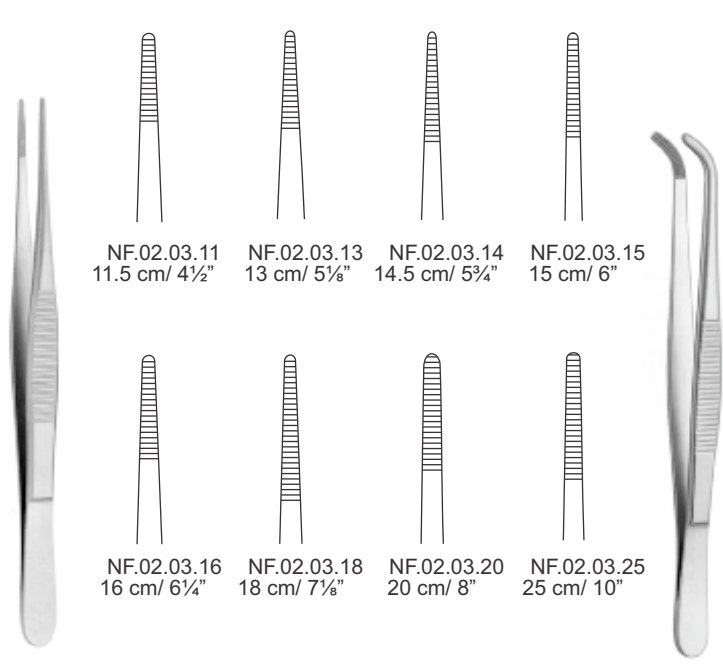

Slim

Standard

- |                              |                            |                              |                            |
|------------------------------|----------------------------|------------------------------|----------------------------|
| NF.02.03.11<br>11.5 cm / 4½" | NF.02.03.13<br>13 cm / 5⅝" | NF.02.03.14<br>14.5 cm / 5¾" | NF.02.03.15<br>15 cm / 6"  |
| NF.02.03.16<br>16 cm / 6¼"   | NF.02.03.18<br>18 cm / 7⅞" | NF.02.03.20<br>20 cm / 8"    | NF.02.03.25<br>25 cm / 10" |

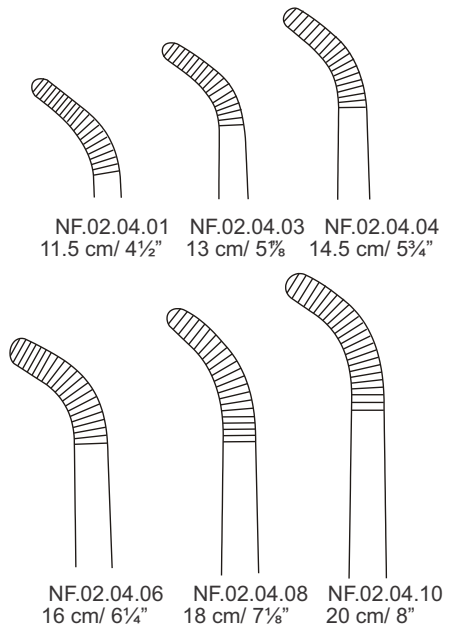

- |                              |                            |                              |
|------------------------------|----------------------------|------------------------------|
| NF.02.04.01<br>11.5 cm / 4½" | NF.02.04.03<br>13 cm / 5⅝" | NF.02.04.04<br>14.5 cm / 5¾" |
| NF.02.04.06<br>16 cm / 6¼"   | NF.02.04.08<br>18 cm / 7⅞" | NF.02.04.10<br>20 cm / 8"    |

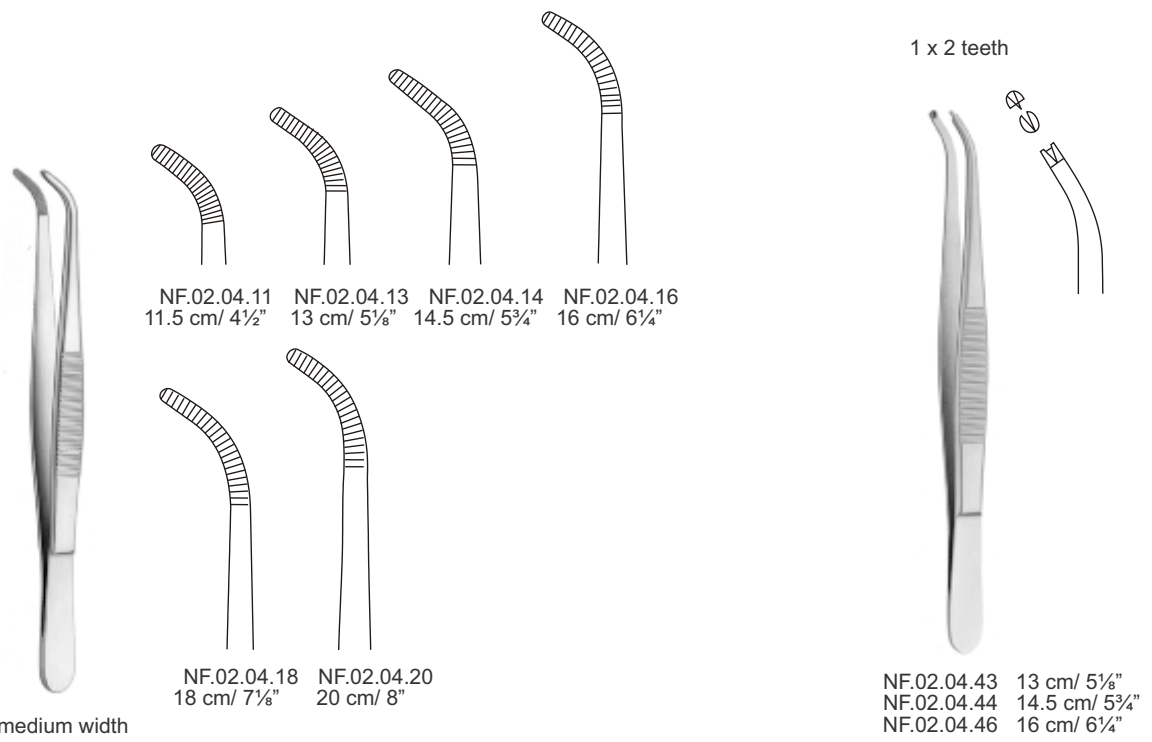

medium width

1 x 2 teeth

- |                              |                            |                              |                            |
|------------------------------|----------------------------|------------------------------|----------------------------|
| NF.02.04.11<br>11.5 cm / 4½" | NF.02.04.13<br>13 cm / 5⅝" | NF.02.04.14<br>14.5 cm / 5¾" | NF.02.04.16<br>16 cm / 6¼" |
| NF.02.04.18<br>18 cm / 7⅞"   | NF.02.04.20<br>20 cm / 8"  |                              |                            |

- |             |               |
|-------------|---------------|
| NF.02.04.43 | 13 cm / 5⅝"   |
| NF.02.04.44 | 14.5 cm / 5¾" |
| NF.02.04.46 | 16 cm / 6¼"   |

# Dressing and Tissue Forceps

1 x 2 teeth



Standard

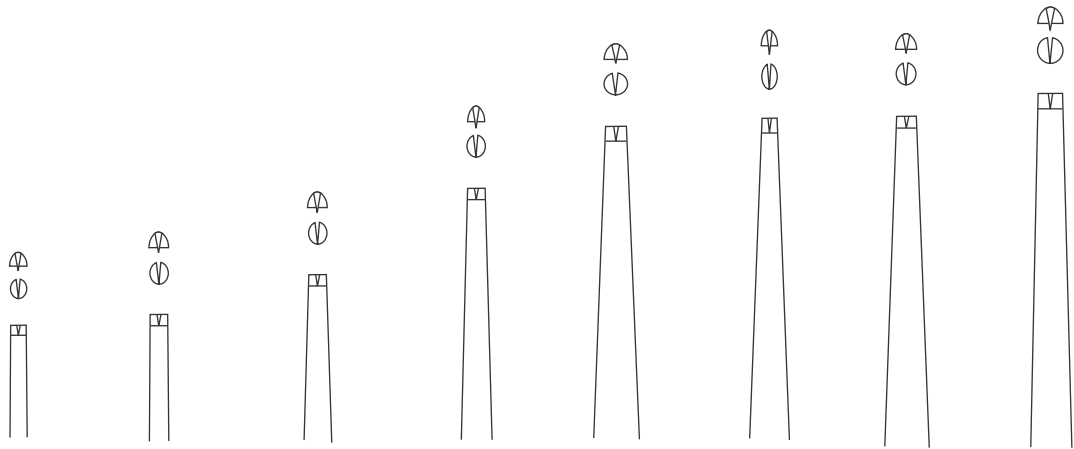

NF.02.05.09 9 cm / 3½"    NF.02.05.10 10.5 cm / 4⅛"    NF.02.05.11 11.5 cm / 4½"    NF.02.05.13 13 cm / 5⅛"    NF.02.05.14 14.5 cm / 5¾"    NF.02.05.15 15 cm / 6"    NF.02.05.16 16 cm / 6¼"    NF.02.05.18 18 cm / 7⅛"

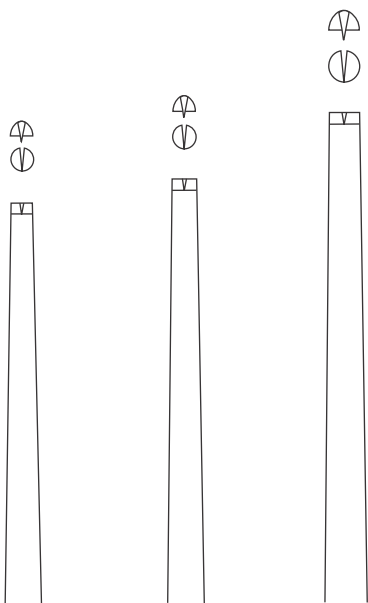

NF.02.05.20 20 cm / 8"    NF.02.05.25 25 cm / 10"    NF.02.05.30 30 cm / 11¾"

1 x 2 teeth



medium width

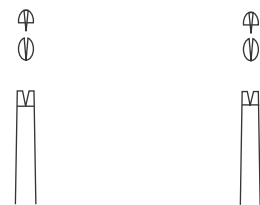

NF.02.06.11 11.5 cm / 4½"    NF.02.06.13 13 cm / 5⅛"

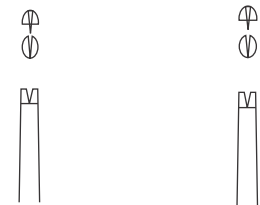

NF.02.06.14 14.5 cm / 5¾"    NF.02.06.16 16 cm / 6¼"

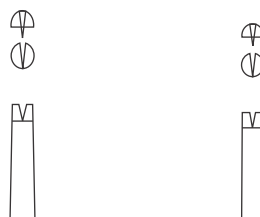

NF.02.06.18 18 cm / 7⅛"    NF.02.06.20 20 cm / 8"



NF.02.06.25 25 cm / 10"    NF.02.06.30 30 cm / 11¾"

# Dressing and Tissue Forceps

1 x 2 teeth

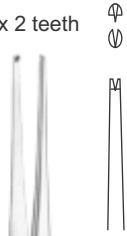

slim

NF.02.07.11  
11.5 cm / 4½"

NF.02.07.13  
13 cm / 5½"

NF.02.07.14  
14.5 cm / 5¾"

NF.02.07.15  
15 cm / 6"

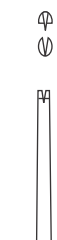

NF.02.07.16  
16 cm / 6¼"



NF.02.07.18  
18 cm / 7½"



NF.02.07.20  
20 cm / 8"



NF.02.07.25  
25 cm / 10"

2 x 3 teeth



NF.02.08.13 13 cm / 5½"  
NF.02.08.14 14.5 cm / 5¾"  
NF.02.08.16 16 cm / 6¼"  
NF.02.08.18 18 cm / 7½"  
NF.02.08.20 20 cm / 8"  
NF.02.08.25 25 cm / 10"

3 x 4 teeth



NF.02.09.13 13 cm / 5½"  
NF.02.09.14 14.5 cm / 5¾"  
NF.02.09.16 16 cm / 6¼"  
NF.02.09.20 20 cm / 8"

4 x 5 teeth

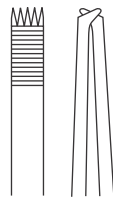

STILLE  
NF.02.10.13  
13 cm / 5½"

4 x 5 teeth



NF.02.10.14 14.5 cm / 5¾"  
NF.02.10.16 16 cm / 6¼"

5 x 6 teeth



LERCHE  
NF.02.10.15  
15 cm / 6"

# Dressing and Tissue Forceps

7 x 7 teeth



NF.02.21.12

9 x 9 teeth  
9 x 9 Zähne  
9 x 9 dientes  
9 x 9 dents  
9 x 9 denti



NF.02.21.13

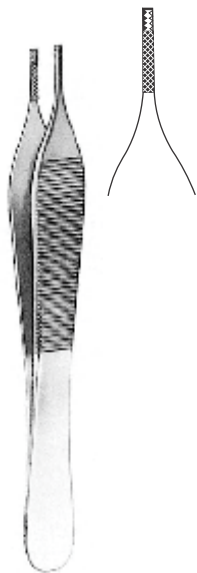

ADSON-BROWN "TC"  
NF.02.21.62  
12 cm / 4¾"



DELACKI  
NF.02.21.72  
12 cm / 4¾"

7 x 7 teeth



ADSON-BROWN  
NF.02.22.72  
12 cm / 4¾"



TREVES  
NF.02.23.13  
13 cm / 5⅝"

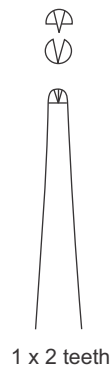

1 x 2 teeth



LANE  
NF.02.23.14 14 cm / 5½"  
NF.02.23.20 20 cm / 8"

1 x 2 teeth



TREVES  
NF.02.23.15  
15 cm / 6"



2 x 3 teeth



ADSON-GRAEFE  
NF.02.23.82  
12 cm / 4¾"



LANE  
NF.02.23.84 14 cm / 5½"  
NF.02.23.90 20 cm / 8"



IRIS

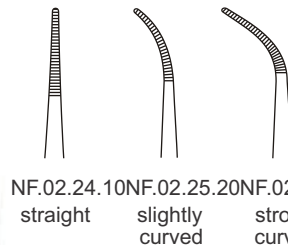

NF.02.24.10 NF.02.25.20 NF.02.26.30  
straight slightly curved strong curved

# Dressing and Tissue Forceps

1 x 2 teeth



NF.02.27.10 straight  
NF.02.28.20 slightly curved  
NF.02.29.30 strong curved

IRIS  
10 cm / 4"



SEMKEN  
serrated jaws

NF.02.30.12 12.5 cm / 5"  
NF.02.30.15 15 cm / 6"

NF.02.31.22 12.5 cm / 5"  
NF.02.31.25 15 cm / 6"

SEMKEN

1 x 2 teeth

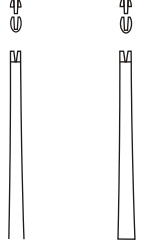

NF.02.32.12 12.5 cm / 5"  
NF.02.32.15 15 cm / 6"

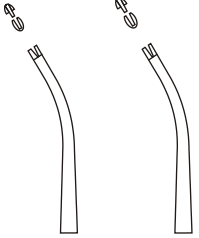

NF.02.33.22 12.5 cm / 5"  
NF.02.33.25 15 cm / 6"

2 x 3 teeth



SEMKEN  
NF.02.34.32  
12.5 cm / 5"



"SELECT"  
serrated jaws

NF.02.34.51 11 cm / 4 1/4"  
NF.02.34.53 13 cm / 5 1/8"  
NF.02.34.55 15 cm / 6"

NF.02.34.58 18 cm / 7 1/8"  
NF.02.34.60 20 cm / 8"

1 x 2 teeth



"SELECT"

NF.02.34.61 11 cm / 4 1/4"  
NF.02.34.68 18 cm / 7 1/8"

NF.02.34.63 13 cm / 5 1/8"  
NF.02.34.65 15 cm / 6"

NF.02.34.70 20 cm / 8"

# Dressing and Tissue Forceps

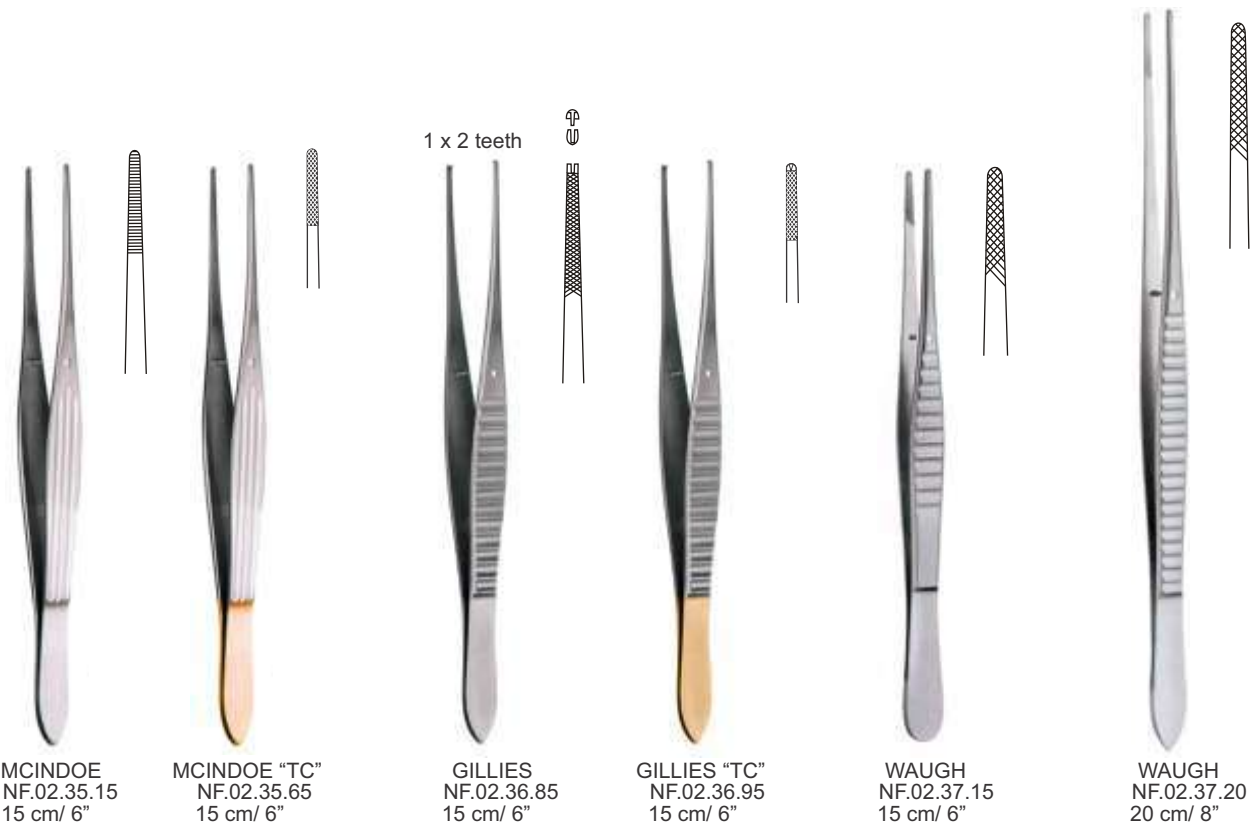

MCINDOE NF.02.35.15 15 cm / 6"  
 MCINDOE "TC" NF.02.35.65 15 cm / 6"  
 GILLIES NF.02.36.85 15 cm / 6"  
 GILLIES "TC" NF.02.36.95 15 cm / 6"  
 WAUGH NF.02.37.15 15 cm / 6"  
 WAUGH NF.02.37.20 20 cm / 8"

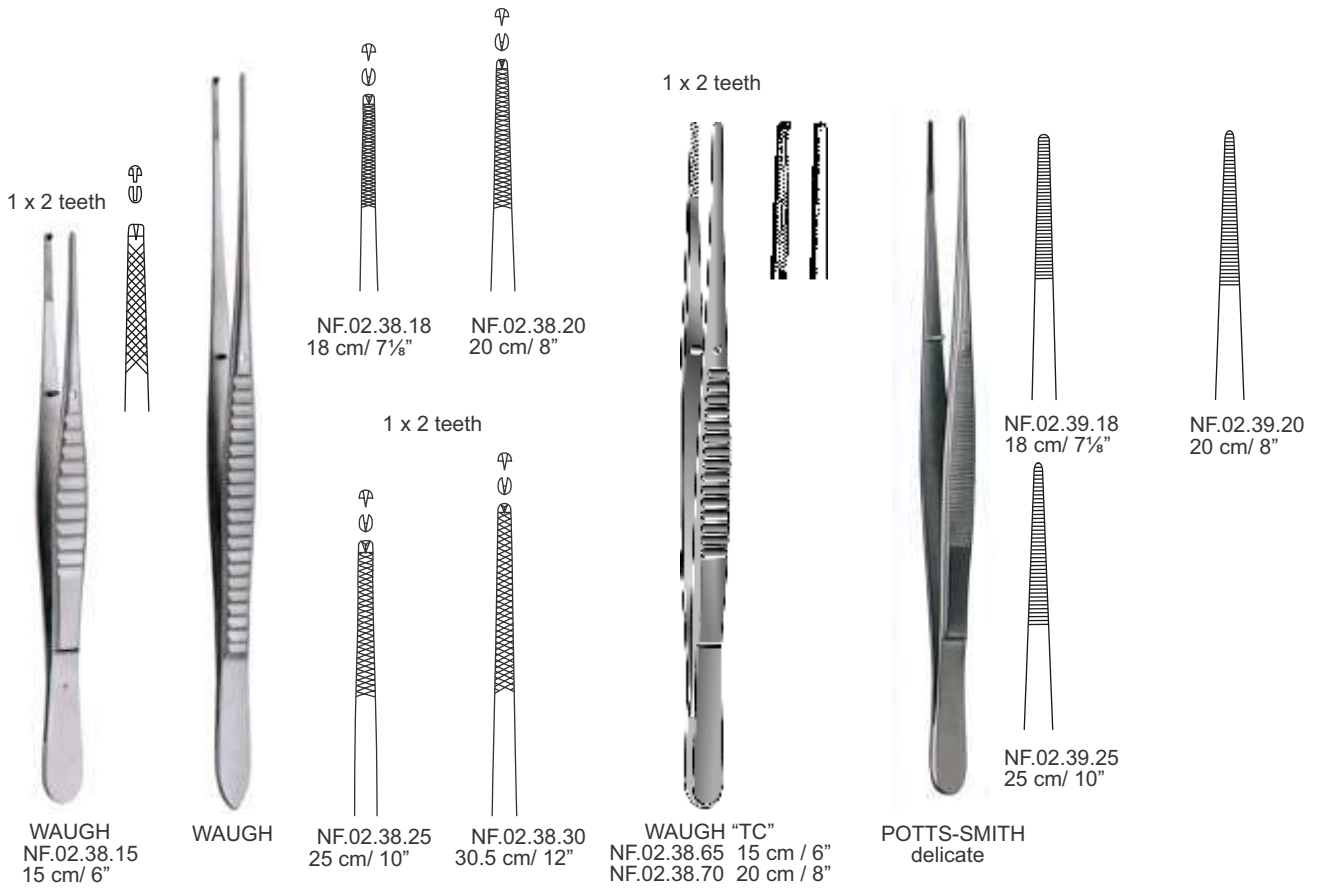

WAUGH NF.02.38.15 15 cm / 6"  
 WAUGH NF.02.38.18 18 cm / 7 1/8"  
 WAUGH NF.02.38.20 20 cm / 8"  
 WAUGH "TC" NF.02.38.65 15 cm / 6"  
 NF.02.38.70 20 cm / 8"  
 POTTS-SMITH delicate NF.02.39.18 18 cm / 7 1/8"  
 NF.02.39.25 25 cm / 10"  
 POTTS-SMITH delicate NF.02.39.20 20 cm / 8"

# Dressing and Tissue Forceps



NF.02.39.65 15 cm / 6"  
 NF.02.39.68 18 cm / 7 1/8"  
 NF.02.39.70 20 cm / 8"  
 NF.02.39.73 23 cm / 9"  
 NF.02.39.75 25 cm / 10"

**POTTS-SMITH  
"TC"**  
standard



NF.02.39.85 14.5 cm / 5 3/4"  
 NF.02.39.88 18 cm / 7 1/8"  
 NF.02.39.93 23 cm / 9"

**POTTS-SMITH  
"TC"**  
extremely delicate

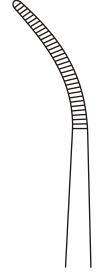

NF.02.40.18  
18 cm / 7 1/8"



NF.02.40.20  
20 cm / 8"

**BROPHY**  
serrated jaws

- 1 x 2 teeth
- 1 x 2 Zähne
- 1 x 2 dientes
- 1 x 2 dents
- 1 x 2 denti

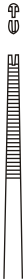

NF.02.41.18  
18 cm / 7 1/8"

**POTTS-SMITH**  
delicate



NF.02.41.20  
20 cm / 8"

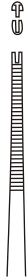

NF.02.41.25  
25 cm / 10"

- 1 x 2 teeth
- 1 x 2 Zähne
- 1 x 2 dientes
- 1 x 2 dents
- 1 x 2 denti

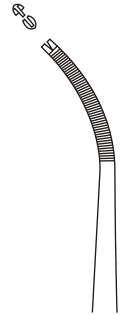

NF.02.42.18  
18 cm / 7 1/8"

**BROPHY**

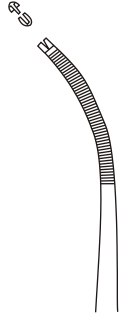

NF.02.42.20  
20 cm / 8"

# Dressing and Tissue Forceps

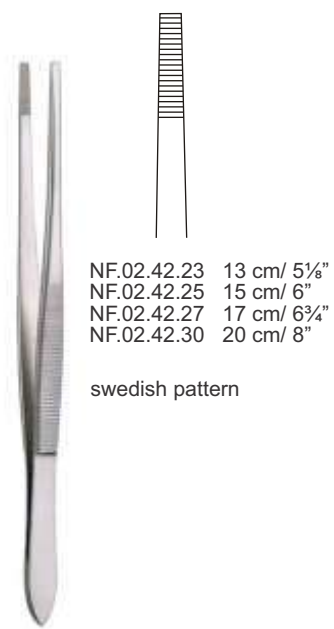

NF.02.42.23 13 cm/ 5 1/8"  
NF.02.42.25 15 cm/ 6"  
NF.02.42.27 17 cm/ 6 3/4"  
NF.02.42.30 20 cm/ 8"

swedish pattern

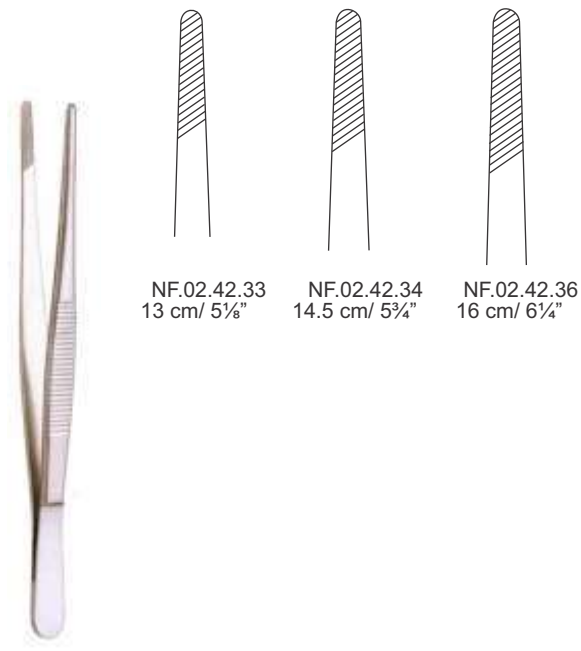

NF.02.42.33 13 cm/ 5 1/8"  
NF.02.42.34 14.5 cm/ 5 3/4"  
NF.02.42.36 16 cm/ 6 1/4"



NF.02.42.40  
20 cm/ 8"

swedish pattern

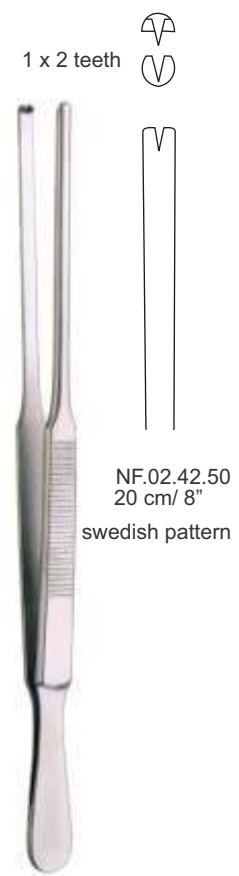

1 x 2 teeth

NF.02.42.50  
20 cm/ 8"

swedish pattern

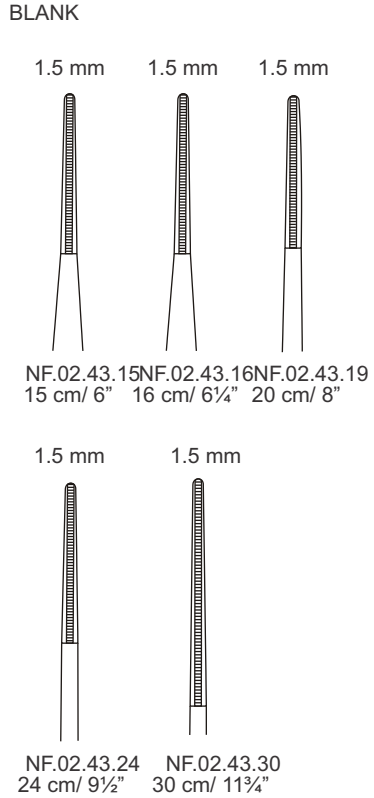

BLANK

1.5 mm 1.5 mm 1.5 mm

NF.02.43.15NF.02.43.16NF.02.43.19  
15 cm/ 6" 16 cm/ 6 1/4" 20 cm/ 8"

1.5 mm 1.5 mm

NF.02.43.24 NF.02.43.30  
24 cm/ 9 1/2" 30 cm/ 11 3/4"

Vascular forceps

DEBAKEY "AT"

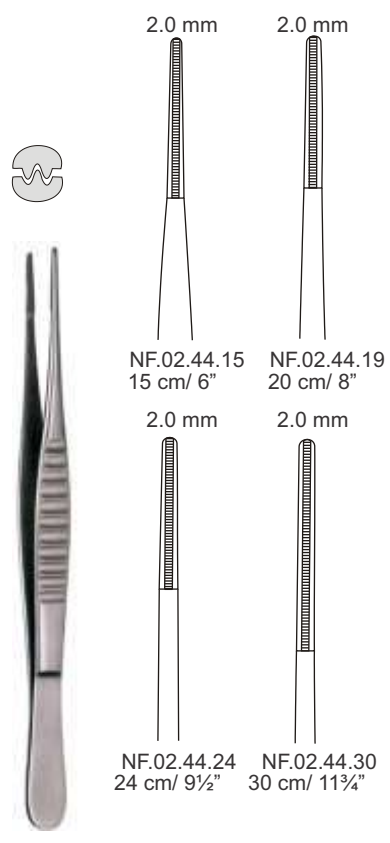

2.0 mm 2.0 mm

NF.02.44.15 NF.02.44.19  
15 cm/ 6" 20 cm/ 8"

2.0 mm 2.0 mm

NF.02.44.24 NF.02.44.30  
24 cm/ 9 1/2" 30 cm/ 11 3/4"

DEBAKEY "AT"



# Dressing and Tissue Forceps

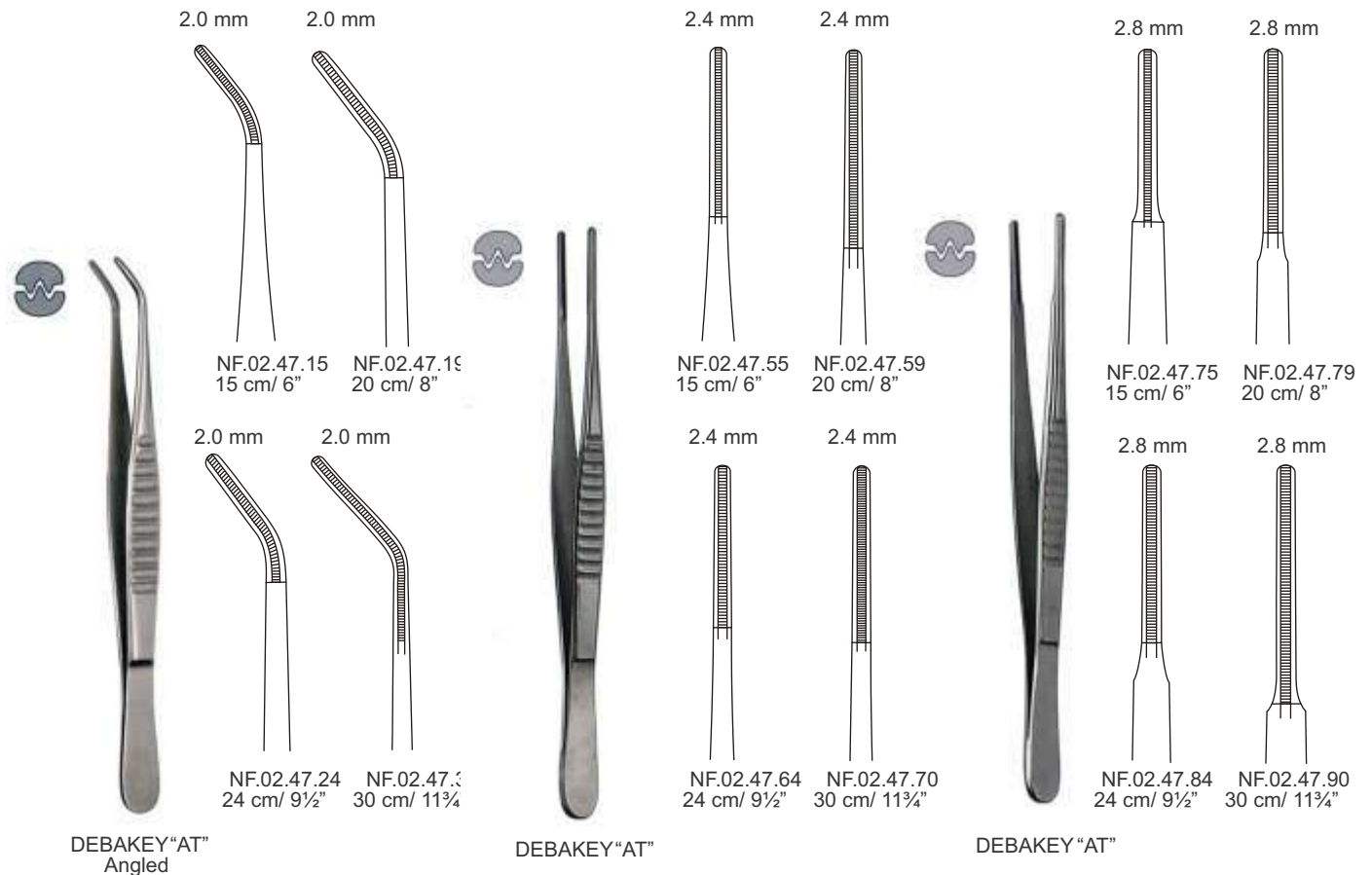
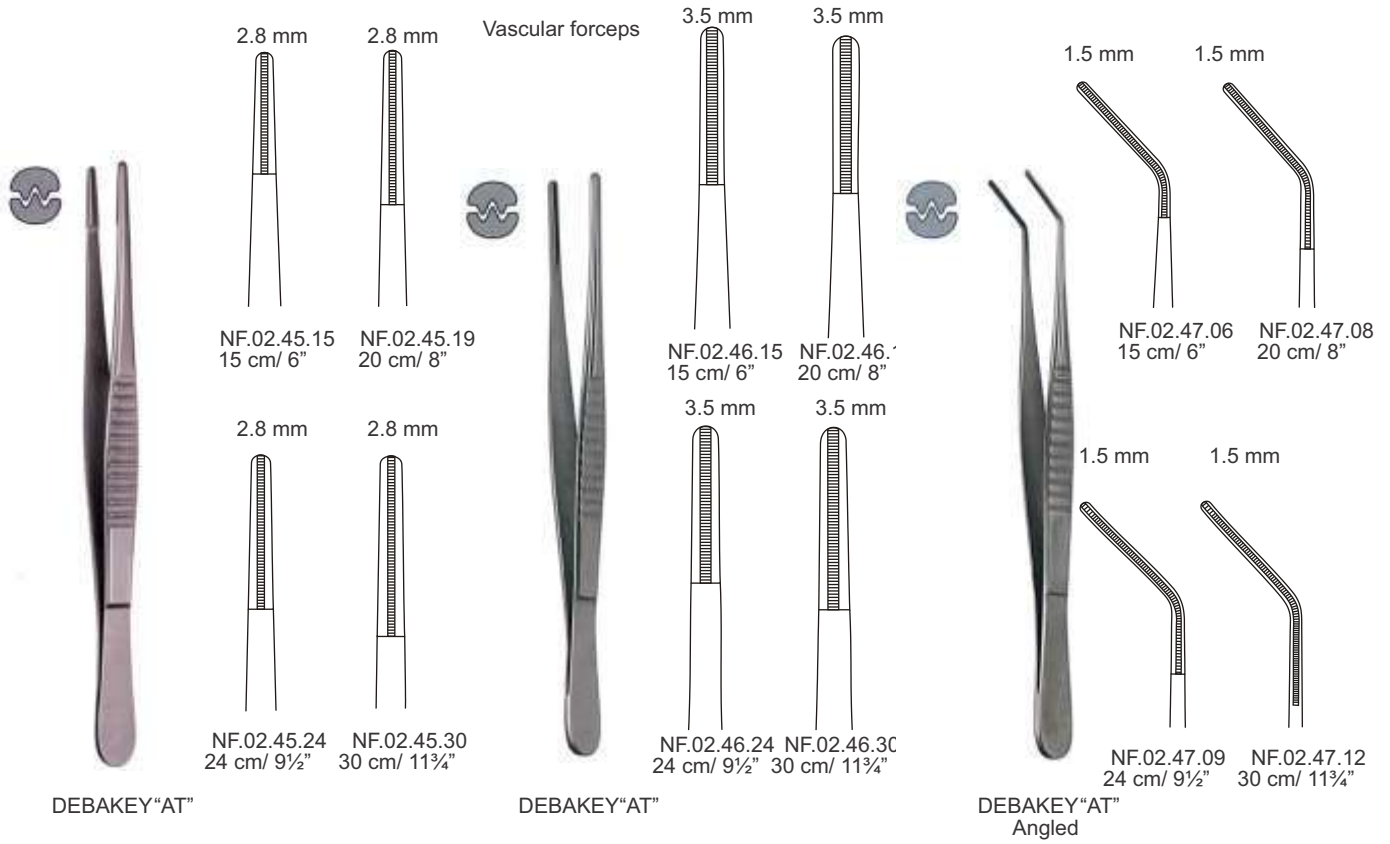

# Dressing and Tissue Forceps

extremely light

1.2 mm  
NF.02.48.45  
15 cm / 6"

1.5 mm  
NF.02.48.50  
20 cm / 8"

1.5 mm  
NF.02.48.54  
24 cm / 9½"

1.5 mm  
NF.02.48.60  
30 cm / 11¼"

NF.02.48.65  
15 cm / 6"

NF.02.48.74  
24 cm / 9½"

NF.02.48.75  
15 cm / 6"

NF.02.48.84  
24 cm / 9½"

NF.02.48.90

DEBAKEY "AT"

GERALD  
18 cm / 7½"

3.5 mm  
NF.02.49.15  
15 cm / 6"

3.5 mm  
NF.02.49.20  
20 cm / 8"

3.5 mm  
NF.02.49.24  
24 cm / 9½"

3.5 mm  
NF.02.49.30  
30 cm / 11¼"

NF.02.48.95

NF.02.50.95

NF.02.49.91

NF.02.50.90

NF.02.51.91

1 x 2 teeth

Vascular forceps

GERALD "TC"  
NF.02.48.95  
18 cm / 7½"

DEBAKEY "AT"

GERALD  
Delicate  
18 cm / 7½"

# Dressing and Tissue Forceps

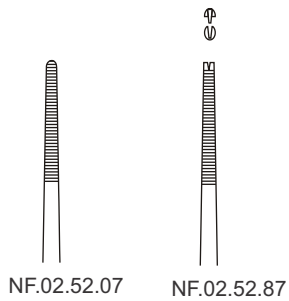

NF.02.52.07

NF.02.52.87



with dissector end

**CUSHING**  
18 cm / 7 1/8"

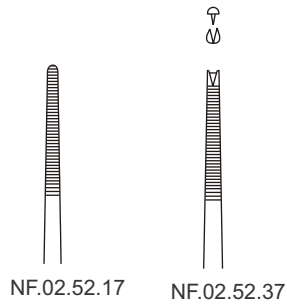

NF.02.52.17

NF.02.52.37



with dissector end

**CUSHING**  
18 cm / 7 1/8"

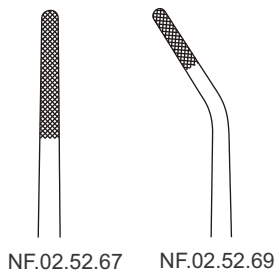

NF.02.52.67

NF.02.52.69



with dissector end

**CUSHING "TC"**  
18 cm / 7 1/8"

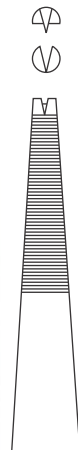

**BONNEY**  
NF.02.52.91  
18 cm / 7 1/8"

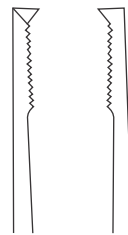

**FERRIS-SMITH**  
18 cm / 7 1/8"

1 x 2 teeth

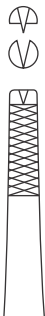

NF.02.53.92

2 x 3 teeth

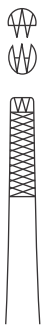

NF.02.54.93

# Dressing and Tissue Forceps

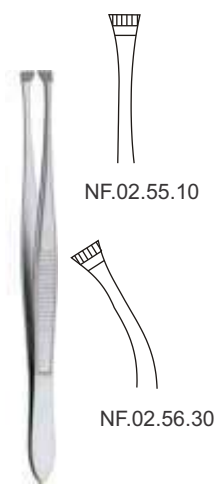

NF.02.55.10

NF.02.56.30

GRAEFE  
11 cm / 4 1/4"

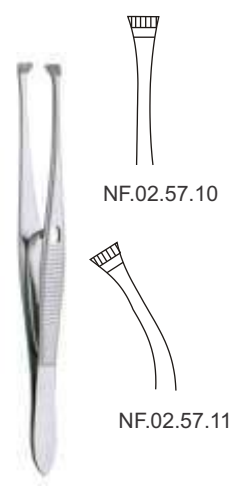

NF.02.57.10

NF.02.57.11

GRAEFE  
11 cm / 4 1/4"



CUSHING (TAYLOR)  
NF.02.55.18 18.5 cm / 7 1/4"  
NF.02.55.19 19.5 cm / 7 3/4"



with dissector end



CUSHING (TAYLOR)  
NF.02.55.28 18.5 cm / 7 1/4"



GERALD  
NF.02.55.39  
19 cm / 7 1/2"



GERALD  
NF.02.55.49  
19 cm / 7 1/2"



GREEN  
10 cm / 4"



5 mm  
NF.02.55.51

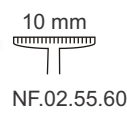

10 mm  
NF.02.55.60



GERALD  
NF.02.55.59  
19 cm / 7 1/2"



CUSHING (TAYLOR) "TC"  
NF.02.55.68  
18.5 cm / 7 1/4"

# Dressing and Tissue Forceps



BROWN

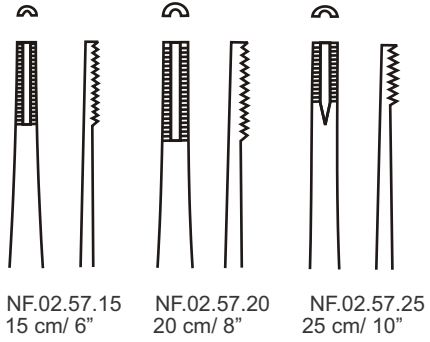

NF.02.57.15 15 cm / 6"  
NF.02.57.20 20 cm / 8"  
NF.02.57.25 25 cm / 10"



DURANTE  
NF.02.57.44 14.5 cm / 5"  
NF.02.57.46 16 cm / 6 1/2"  
NF.02.57.50 20 cm / 8"



TUTTLE  
NF.02.58.18 18 cm / 7 1/8"  
NF.02.58.23 23 cm / 9"



RUSS. MOD

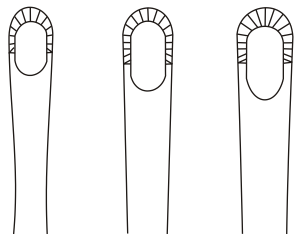

NF.02.59.15 15 cm / 6"  
NF.02.59.20 20 cm / 8"  
NF.02.59.25 25 cm / 10"



MAYO  
NF.02.59.33 23 cm / 9"



WANGENSTEEN  
NF.02.59.45 15 cm / 6"  
NF.02.59.53 23 cm / 9"  
NF.02.59.55 25 cm / 10"

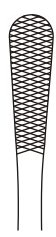

WANGENSTEEN "TC"  
NF.02.59.65 15 cm / 6"  
NF.02.59.73 23 cm / 9"  
NF.02.59.74 25 cm / 10"



# Dressing and Tissue Forceps

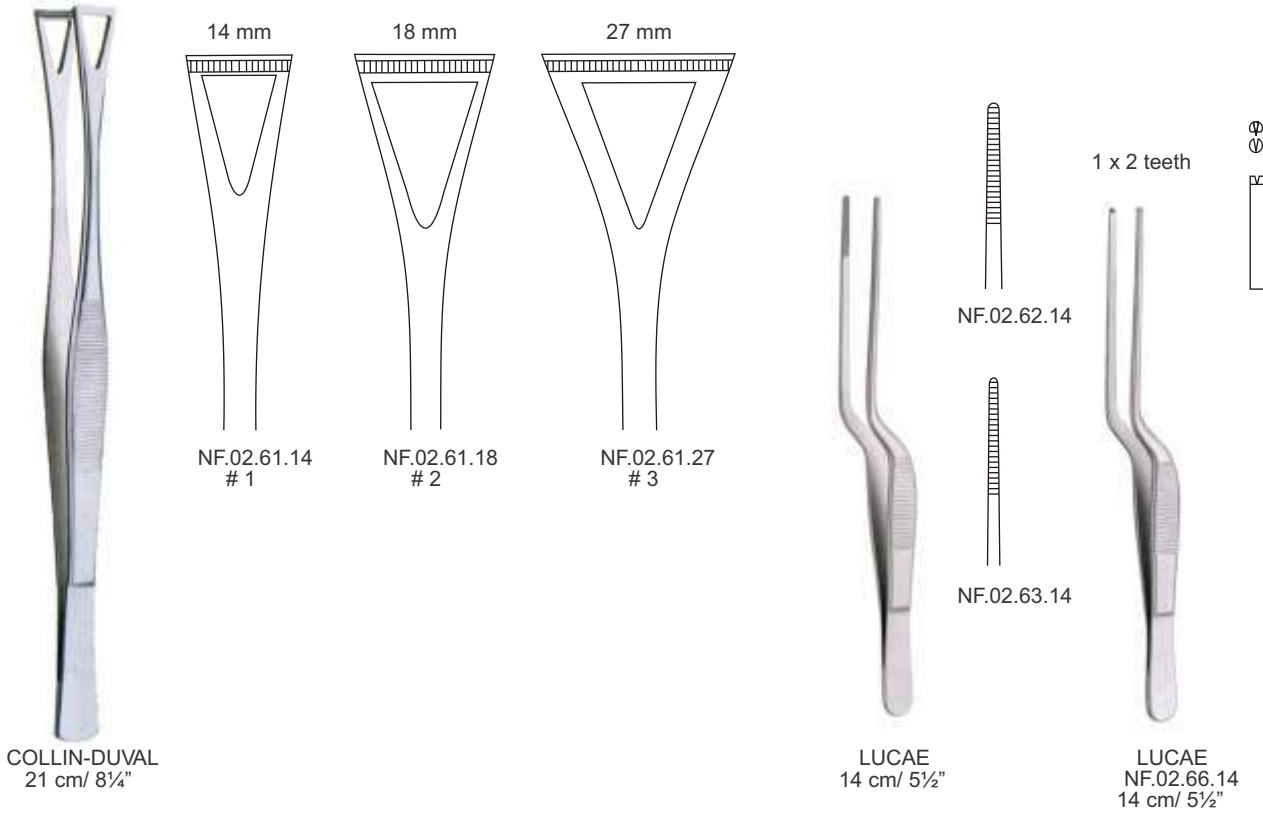
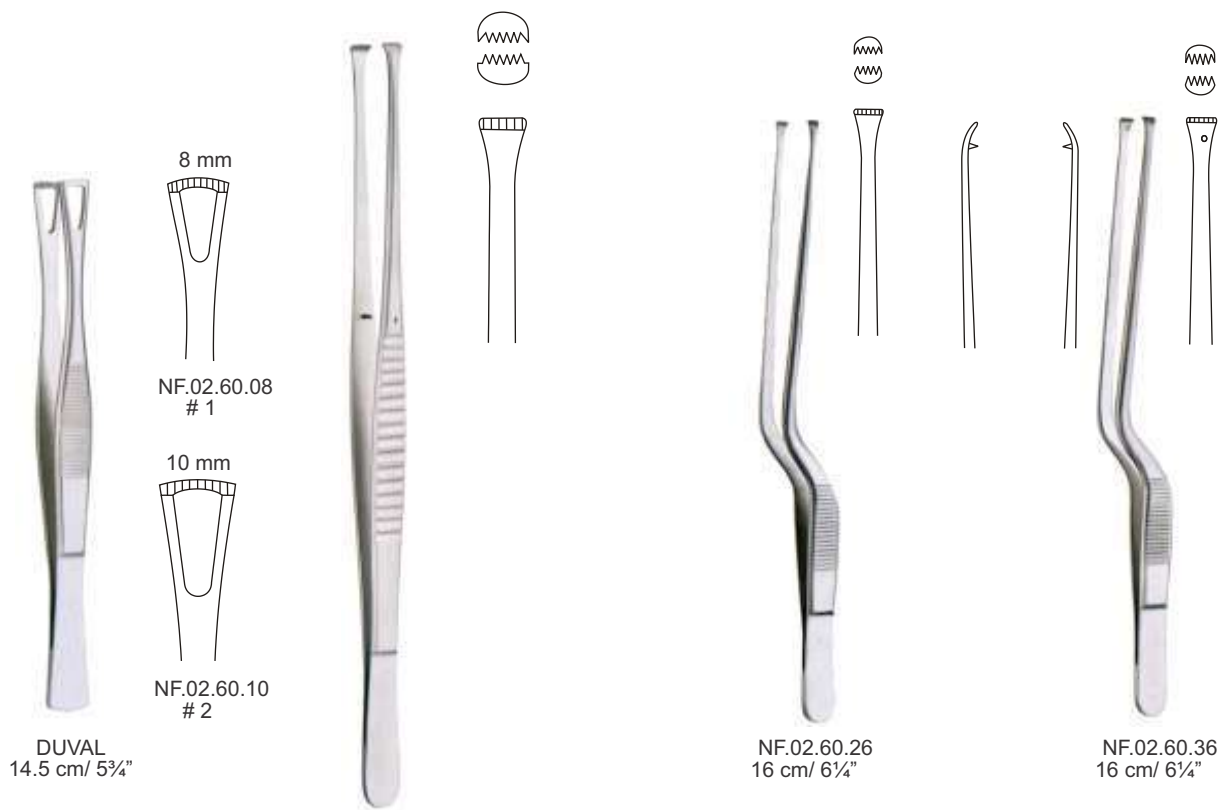

# Dressing and Tissue Forceps

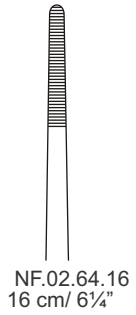

NF.02.64.16  
16 cm / 6 1/4"



NF.02.65.19  
19.5 cm / 7 3/4"

GRUENWALD

1 x 2 teeth



NF.02.67.16  
16 cm / 6 1/4"



NF.02.67.19  
19.5 cm / 7 3/4"

GRUENWALD



TROELTSCH (WILDE)  
NF.02.68.10  
10 cm / 4"



TROELTSCH (WILDE)  
NF.02.69.11  
11 cm / 4 1/4"



TROELTSCH (WILDE)  
NF.02.70.13  
13 cm / 5 1/8"



TROELTSCH (WILDE)  
NF.02.71.17  
17 cm / 6 3/4"

# Dressing and Tissue Forceps



NF.02.71.84  
23 cm / 9"

TROELTSCH  
NF.02.72.73  
13 cm / 5 1/8"

TROELTSCH (WILDE)  
NF.02.74.11  
11 cm / 4 1/4"

TROELTSCH (WILDE)  
NF.02.74.13  
13 cm / 5 1/8"

TROELTSCH  
NF.02.75.14  
14 cm / 5 1/2"

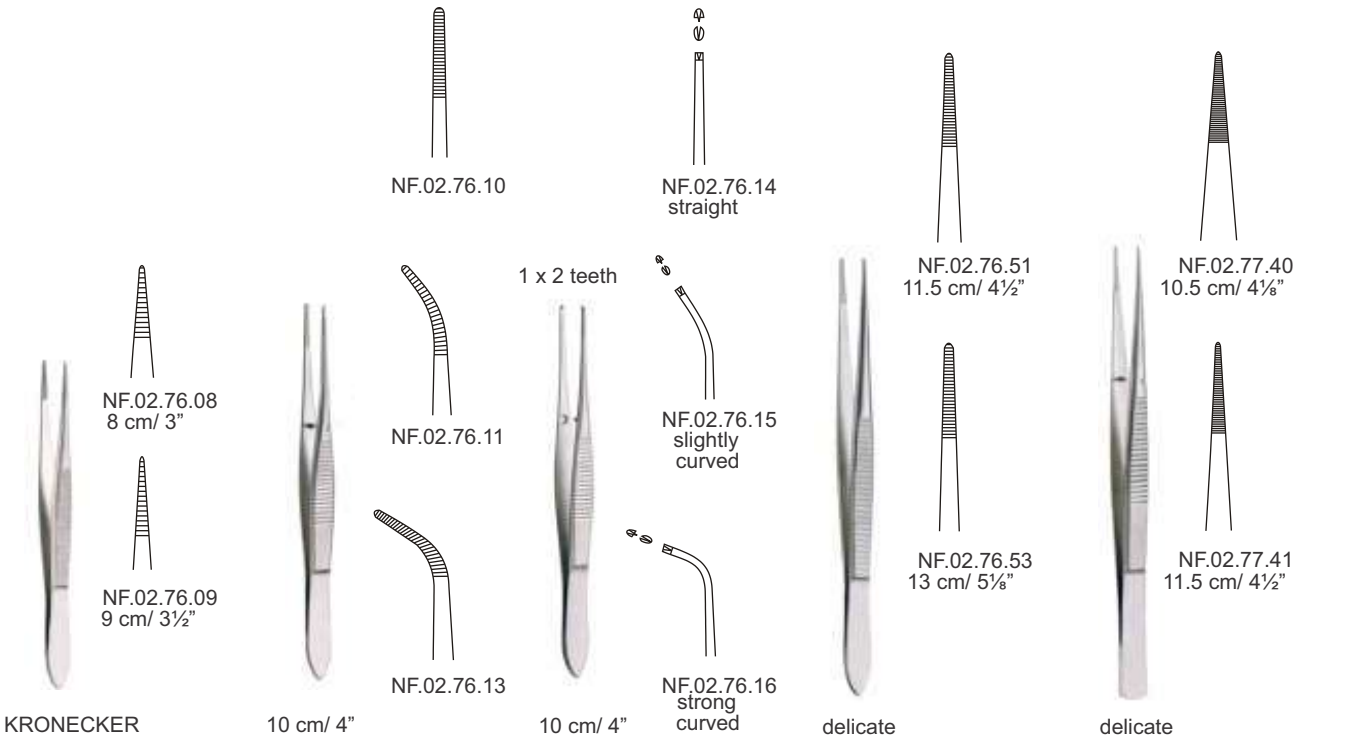

NF.02.76.10

NF.02.76.14  
straight

NF.02.76.51  
11.5 cm / 4 1/2"

NF.02.77.40  
10.5 cm / 4 1/8"

NF.02.76.08  
8 cm / 3"

NF.02.76.11

NF.02.76.15  
slightly curved

NF.02.76.53  
13 cm / 5 1/8"

NF.02.77.41  
11.5 cm / 4 1/2"

KRONECKER

10 cm / 4"

10 cm / 4"

NF.02.76.16  
strong curved

delicate

delicate



# Dressing and Tissue Forceps

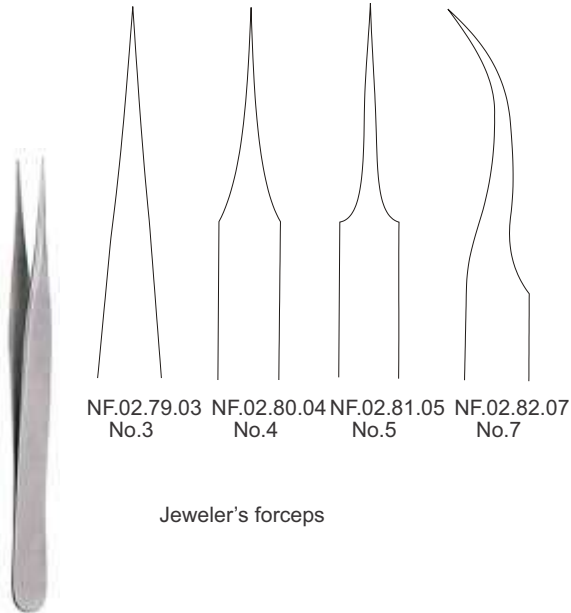

NF.02.79.03 No.3  
NF.02.80.04 No.4  
NF.02.81.05 No.5  
NF.02.82.07 No.7

Jeweler's forceps

11.5 cm/ 4½"

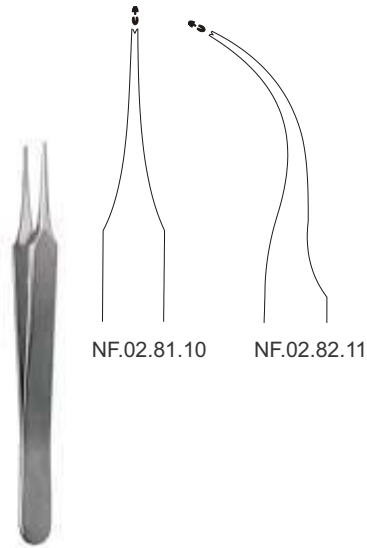

NF.02.81.10  
NF.02.82.11

11.5 cm/ 4½"

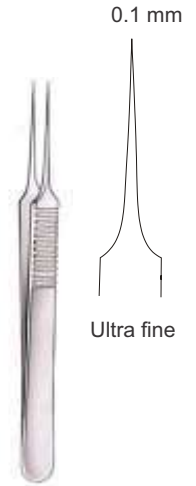

KOSHIMA  
NF.02.83.51  
11 cm/ 4¼"



PEET  
NF.02.85.11  
11.5 cm/ 4½"

ARTHUR  
NF.02.86.04  
14 cm/ 5½"

STIEGLITZ  
(WILLIAMS)

NF.02.87.14  
14 cm/ 5½"

NF.02.88.24  
13 cm/ 5⅛"

NF.02.88.34  
12 cm/ 4¾"

RALK (VIRTUS)  
14 cm/ 5½"

NF.02.89.14

NF.02.89.24

# Dressing and Tissue Forceps

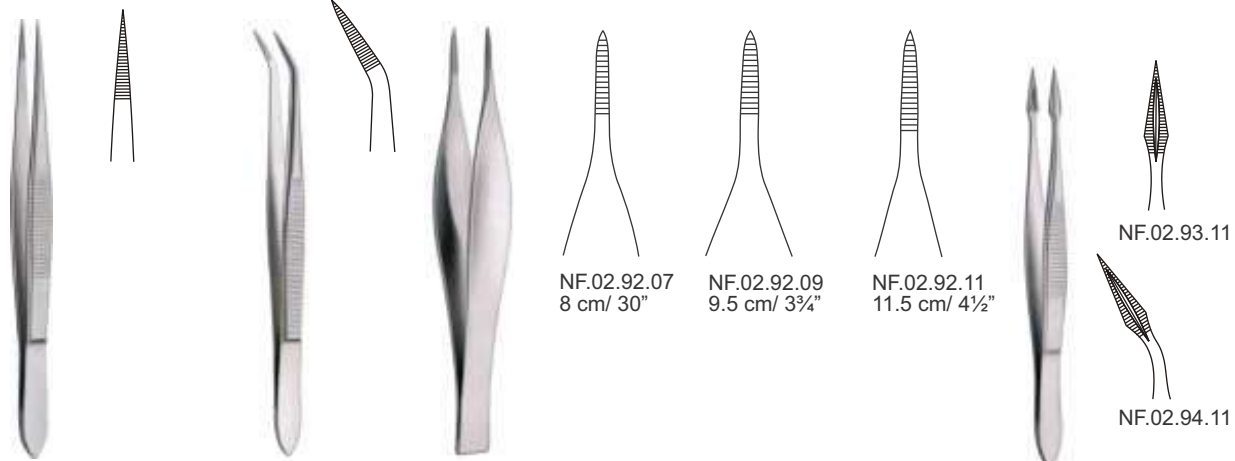

**SPLINTER**  
NF.02.90.08 8 cm/ 3"  
NF.02.90.09 9 cm/ 3½"  
NF.02.90.10 10.5 cm/ 4⅞"  
NF.02.90.11 11.5 cm/ 4½"

**SPLINTER**  
NF.02.91.08 8 cm/ 3"  
NF.02.91.09 9 cm/ 3½"  
NF.02.91.10 10 cm/ 4"  
NF.02.91.11 11 cm/ 4¼"

NF.02.92.07 8 cm/ 30"  
NF.02.92.09 9.5 cm/ 3¾"  
NF.02.92.11 11.5 cm/ 4½"

NF.02.93.11  
NF.02.94.11

**HUNTER**  
11 cm/ 4¼"

**FEILCHENFELD**

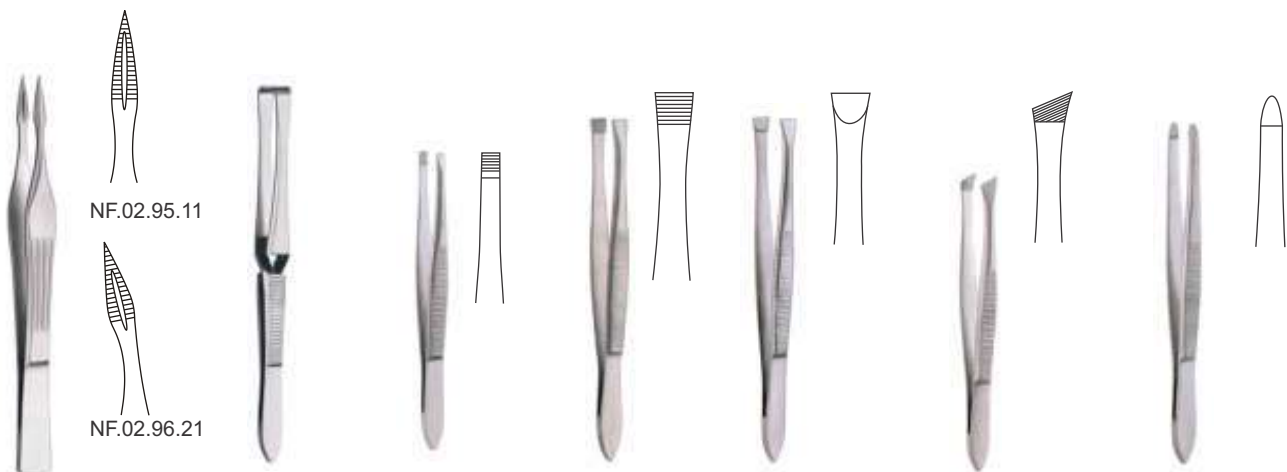

NF.02.95.11  
NF.02.96.21

**WALTER**  
11 cm/ 4¼"

NF.02.97.10 10 cm/ 4"  
Tick forceps

**DOUGLAS**  
NF.02.98.08 8 cm/ 3"

NF.02.99.09 9 cm/ 3½"

**LITTAUER**  
NF.02.99.19 9 cm/ 3½"

**BERGH**  
NF.02.99.28 8 cm/ 3"

**ZIEGLER**  
NF.02.99.29 9 cm/ 3½"

# Dressing and Tissue Forceps



NF.03.98.40  
19.5 cm / 7 3/4"



NF.03.99.59  
19.5 cm / 7 3/4"



NF.03.100.60  
19.5 cm / 7 3/4"



18.5 cm / 7 1/4"

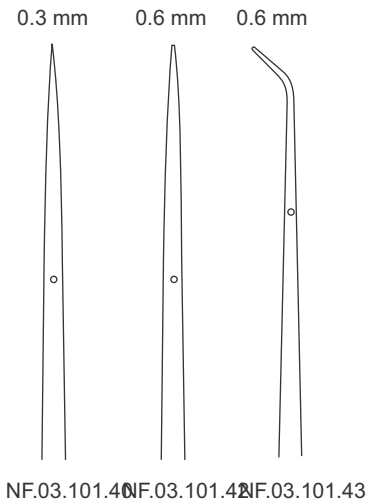

NF.03.101.40 NF.03.101.42 NF.03.101.43



NF.03.101.60  
19 cm / 7 1/2"

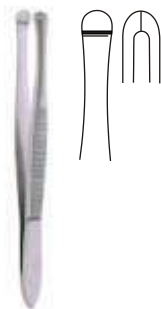

BEER  
NF.03.102.06 6 cm / 2 3/8"  
NF.03.102.09 8 cm / 3"



BEER  
NF.03.102.07  
8 cm / 3"

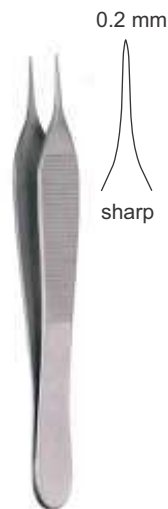

JACOBSON-ADSON  
NF.03.102.12  
12 cm / 4 3/4"

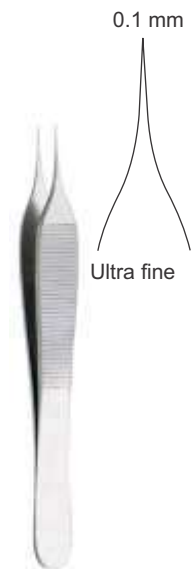

JACOBSON-ADSON  
(KOSHIMA)  
NF.03.102.42  
12 cm / 4 3/4"

# Dressing and Tissue Forceps



**JACOBSON-ADSON**  
NF.03.103.15  
15 cm / 6"



**JACOBSON**

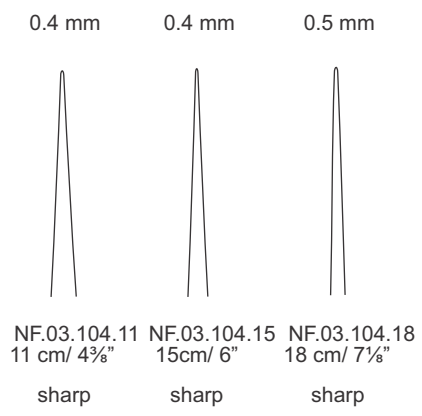

NF.03.104.11 11 cm / 4 3/8" sharp  
NF.03.104.15 15 cm / 6" sharp  
NF.03.104.18 18 cm / 7 1/8" sharp



**BARRAQUER**  
NF.03.105.10  
10.5 cm / 4 1/8"



**GRADLE**  
NF.03.105.11  
10.5 cm / 4 1/8"



NF.03.105.19  
19.5 cm / 7 3/4"



NF.03.105.50



NF.03.105.51

16.5 cm / 6 1/2"



NF.03.106.20  
19.5 cm / 7 3/4"



NF.03.106.52  
19 cm / 7 1/2"



**CILIA**  
NF.03.107.11  
10.5 cm / 4 1/8"



**MICRO 2000**  
NF.03.108.13  
12.5 cm / 5"

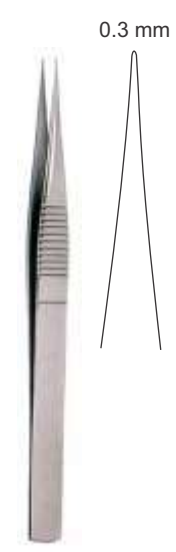

**MICRO 2000**  
NF.03.109.13  
12.5 cm / 5"

# Dressing and Tissue Forceps

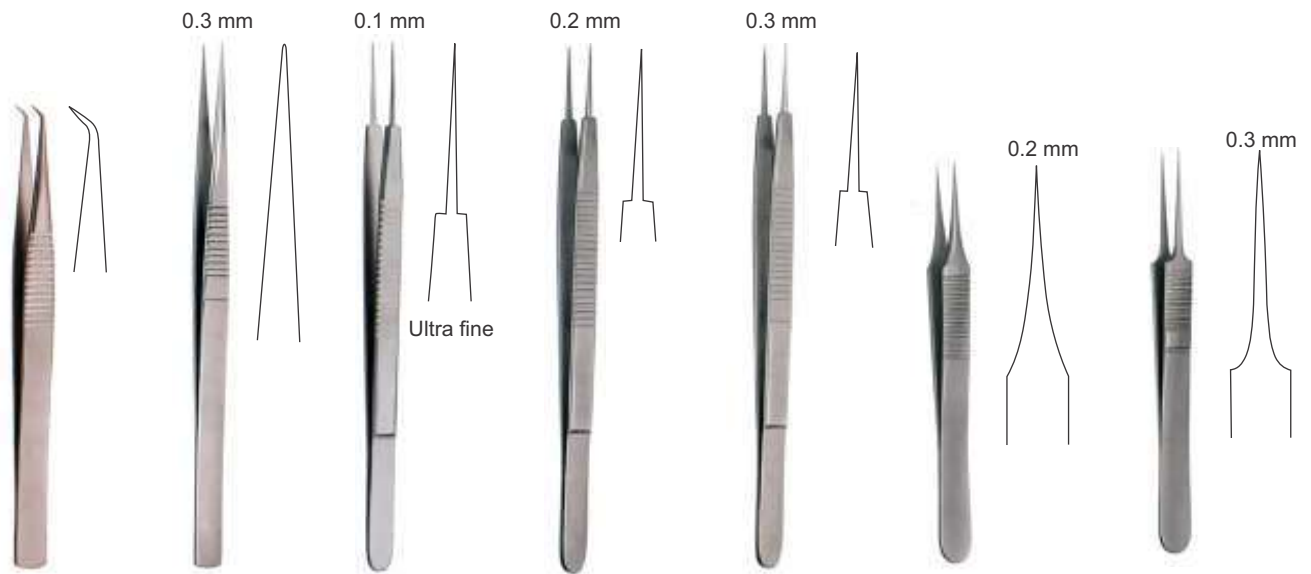

MICRO 2000  
NF.03.110.13  
12.5 cm / 5"

MICRO 2000  
NF.03.111.13  
13.5 cm / 5 1/4"

MICRO 2000  
(KOSHIMA)  
NF.03.111.14  
14 cm / 5 1/2"

MICRO 2000  
NF.03.112.14  
14 cm / 5 1/2"

MICRO 2000  
NF.03.113.14  
14 cm / 5 1/2"

MICRO 2000  
NF.03.114.11  
10.5 cm / 4 1/8"

MICRO 2000  
NF.03.115.11  
10.5 cm / 4 1/8"

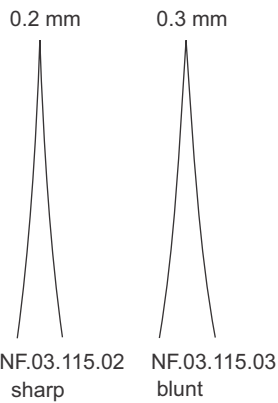

NF.03.115.02  
sharp

NF.03.115.03  
blunt

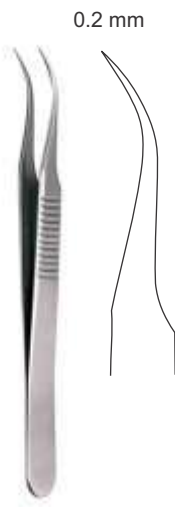

MICRO 2000  
12 cm / 4 3/4"

NF.03.116.02  
sharp

NF.03.116.03  
blunt

MICRO 2000  
NF.03.116.12  
11.5 cm / 4 1/2"

MICRO 2000  
NF.03.117.12  
11.5 cm / 4 1/2"

MICRO 2000  
NF.03.118.11  
10.5 cm / 4 1/8"

MICRO 2000  
NF.03.119.11  
10.5 cm / 4 1/8"

MICRO 2000  
NF.03.120.11  
11.5 cm / 4 1/2"

# Dressing and Tissue Forceps

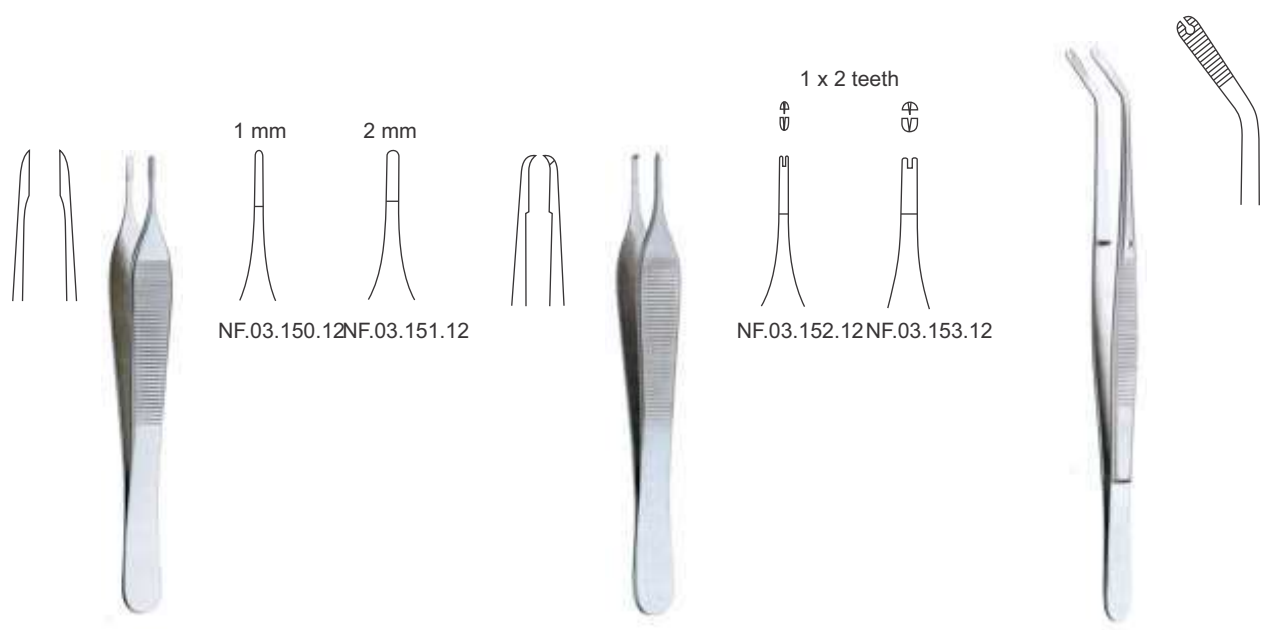

**ADSON**  
12 cm / 4¾"

1 mm 2 mm  
NF.03.150.12 NF.03.151.12

**ADSON**  
12 cm / 4¾"

1 x 2 teeth  
NF.03.152.12 NF.03.153.12

**NF.03.154.15**  
15 cm / 6"

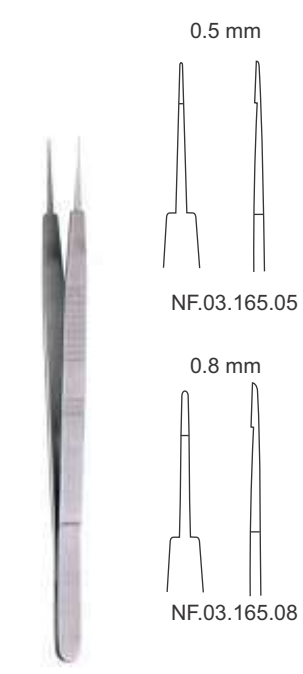

**MICRO 2000**  
14 cm / 5½"

0.5 mm  
NF.03.165.05

0.8 mm  
NF.03.165.08

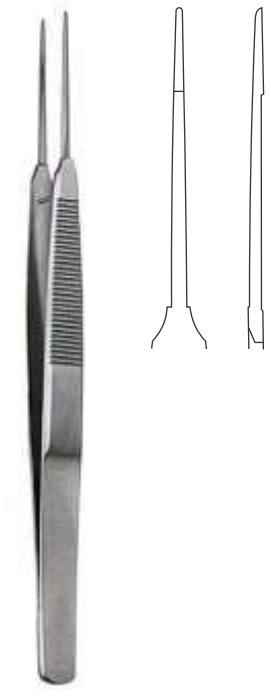

**AUSTIN**  
NF.03.166.08  
18 cm / 7⅛"

0.8 mm



**MICRO 2000**  
12 cm / 4¾"

0.3 mm  
NF.03.167.03

0.3 mm  
NF.03.168.03

# Dressing and Tissue Forceps



12 cm/ 4¾"  
15 cm/ 6"  
18 cm/ 7¼"



0.3 mm  
NF.03.170.12  
NF.03.170.15  
NF.03.170.18



0.3 mm  
NF.03.171.12  
NF.03.171.15  
NF.03.171.18



0.3 mm  
NF.03.172.12  
NF.03.172.15  
NF.03.172.18



0.3 mm  
NF.03.173.12  
NF.03.173.15  
NF.03.173.18



NF.03.175.23  
23 cm/ 9"



0.6 mm



# Sponge Forceps





# Sponge Forceps



LISTER

NF.03.01.13  
13 cm / 5 1/8"



NF.03.01.15  
15 cm / 6"



NF.03.01.18  
18 cm / 7 1/8"



NF.03.03.17  
17.5 cm / 7"

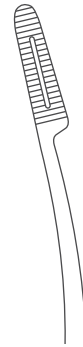

MAIER  
26 cm / 10 1/4"

NF.03.07.26



NF.03.08.2

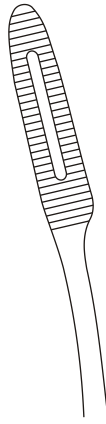

MAIER  
26 cm / 10 1/4"

NF.03.09.26



NF.03.10.26

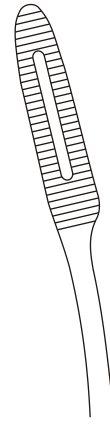

# Sponge Forceps



GROSS-MAIER

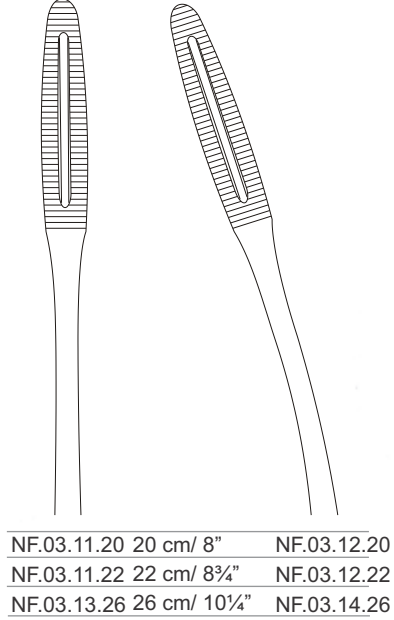

NF.03.11.20	20 cm/ 8"	NF.03.12.20
NF.03.11.22	22 cm/ 8¾"	NF.03.12.22
NF.03.13.26	26 cm/ 10¼"	NF.03.14.26



PELKMANN  
25 cm/ 10"

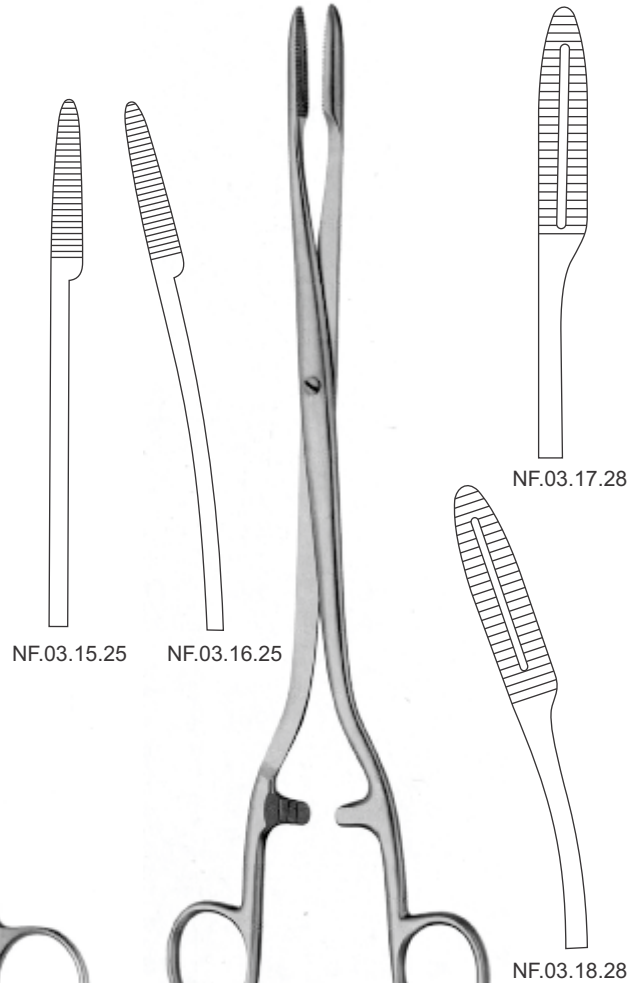

NF.03.15.25      NF.03.16.25

NF.03.17.28

NF.03.18.28

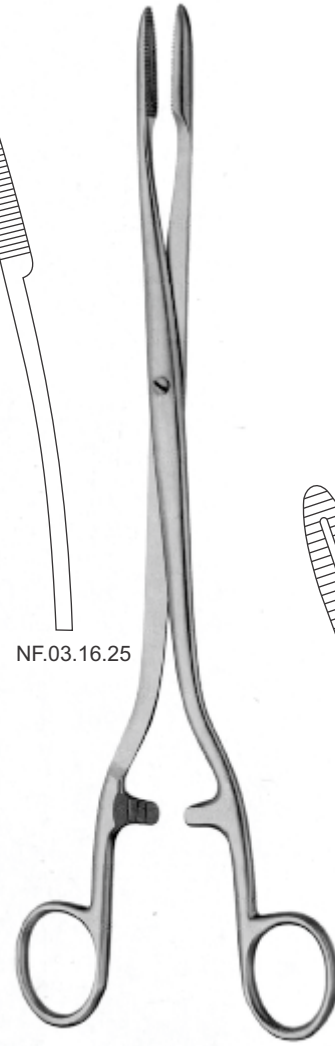

SIMS-MAIER  
28 cm/ 11"



GROSS-MAIER

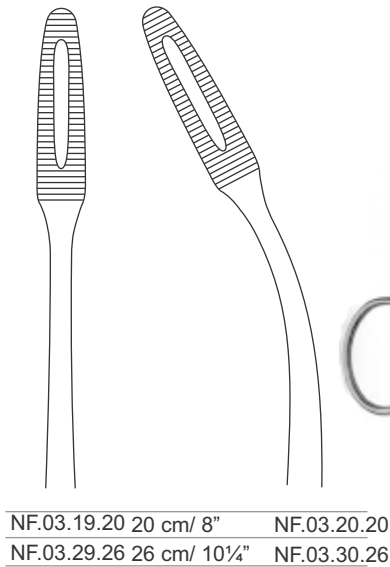

NF.03.19.20	20 cm/ 8"	NF.03.20.20
NF.03.29.26	26 cm/ 10¼"	NF.03.30.26

# Sponge Forceps

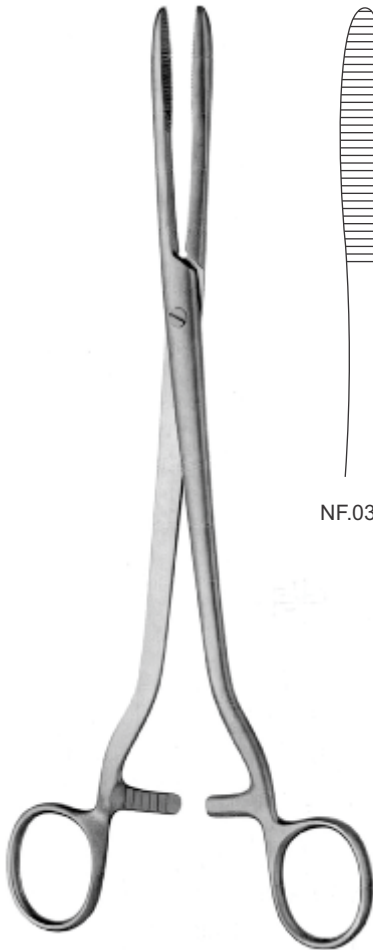

**COLLIN**  
25 cm / 10"

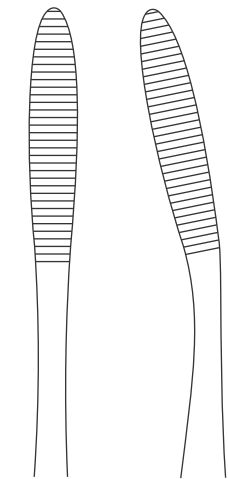

NF.03.21.25    NF.03.22.45



**CHERON**  
NF.03.23.75  
26 cm / 10 1/4"

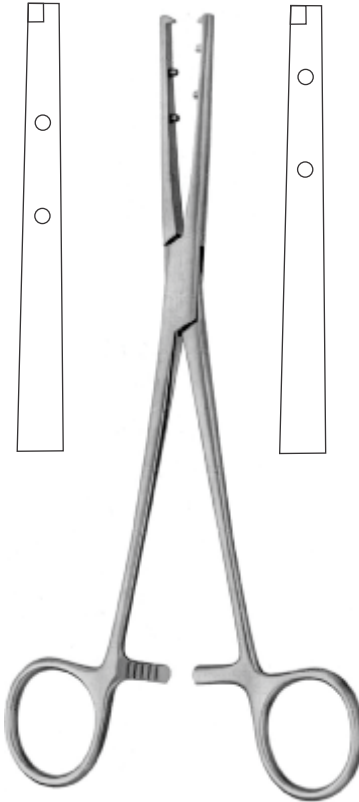

**EMMET**  
NF.03.24.21  
21 cm / 8 1/4"



NF.03.25.18  
18 cm / 7 1/8"

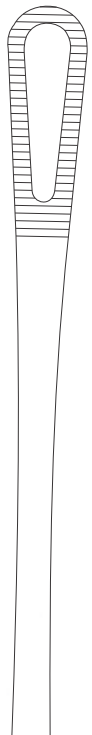

NF.03.26.25  
25 cm / 10"

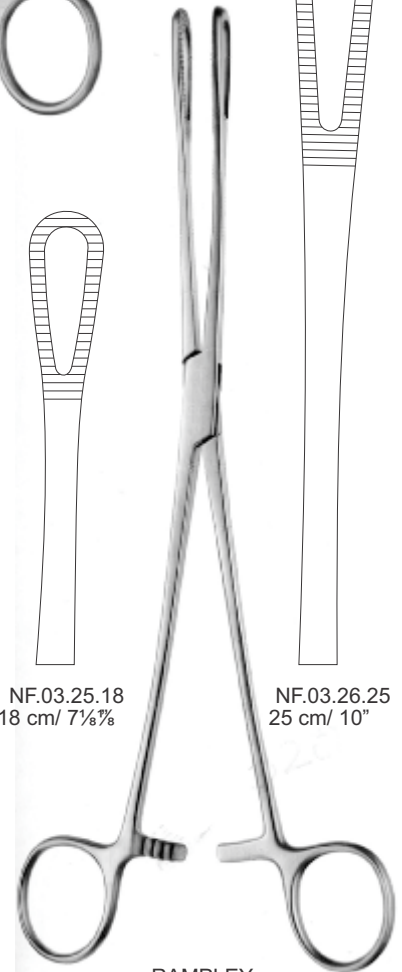

**RAMPLEY**

# Sponge Forceps

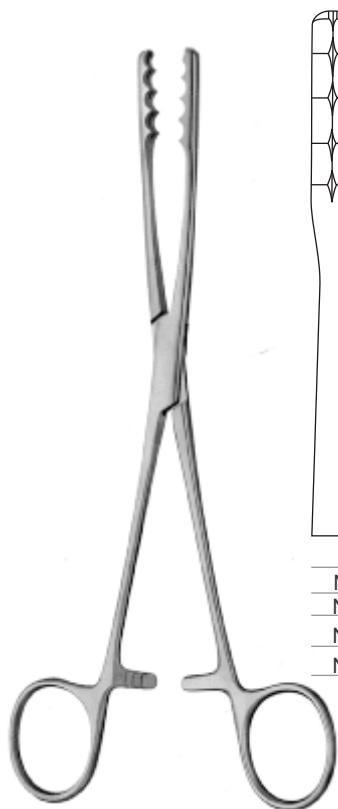

ULRICH

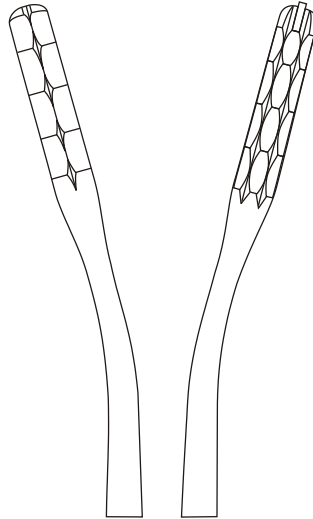

NF.03.27.18	18 cm/ 7"	NF.03.28.18
NF.03.27.20	20 cm/ 8"	NF.03.28.20
NF.03.27.22	22 cm/ 8¾"	NF.03.28.22
NF.03.27.26	26 cm/ 10¼"	NF.03.28.26

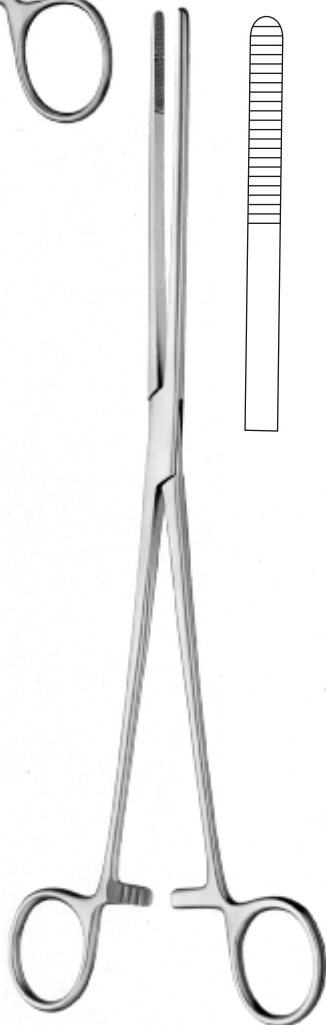

BOZEMANN  
NF.03.33.26  
27 cm/ 10¾"

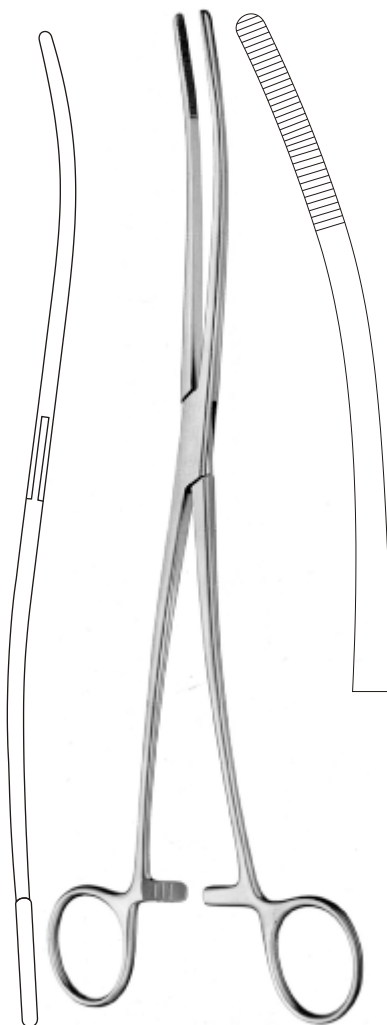

BOZEMANN  
NF.03.34.26  
27 cm/ 10¾"

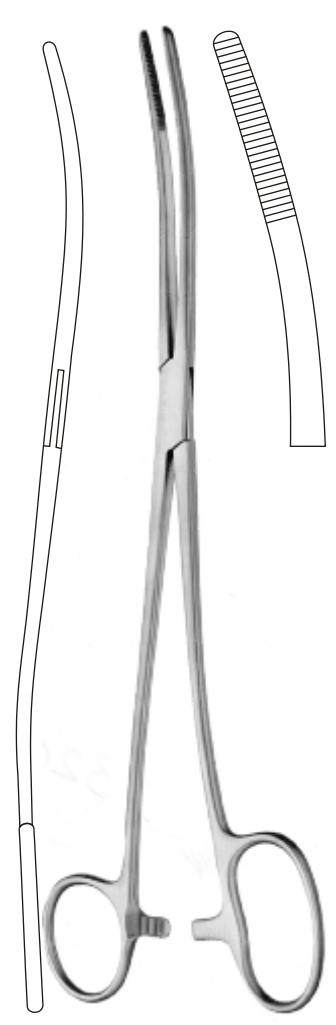

BOZEMANN DOUGLAS  
NF.03.35.26  
26 cm/ 10¼"

# Sponge Forceps

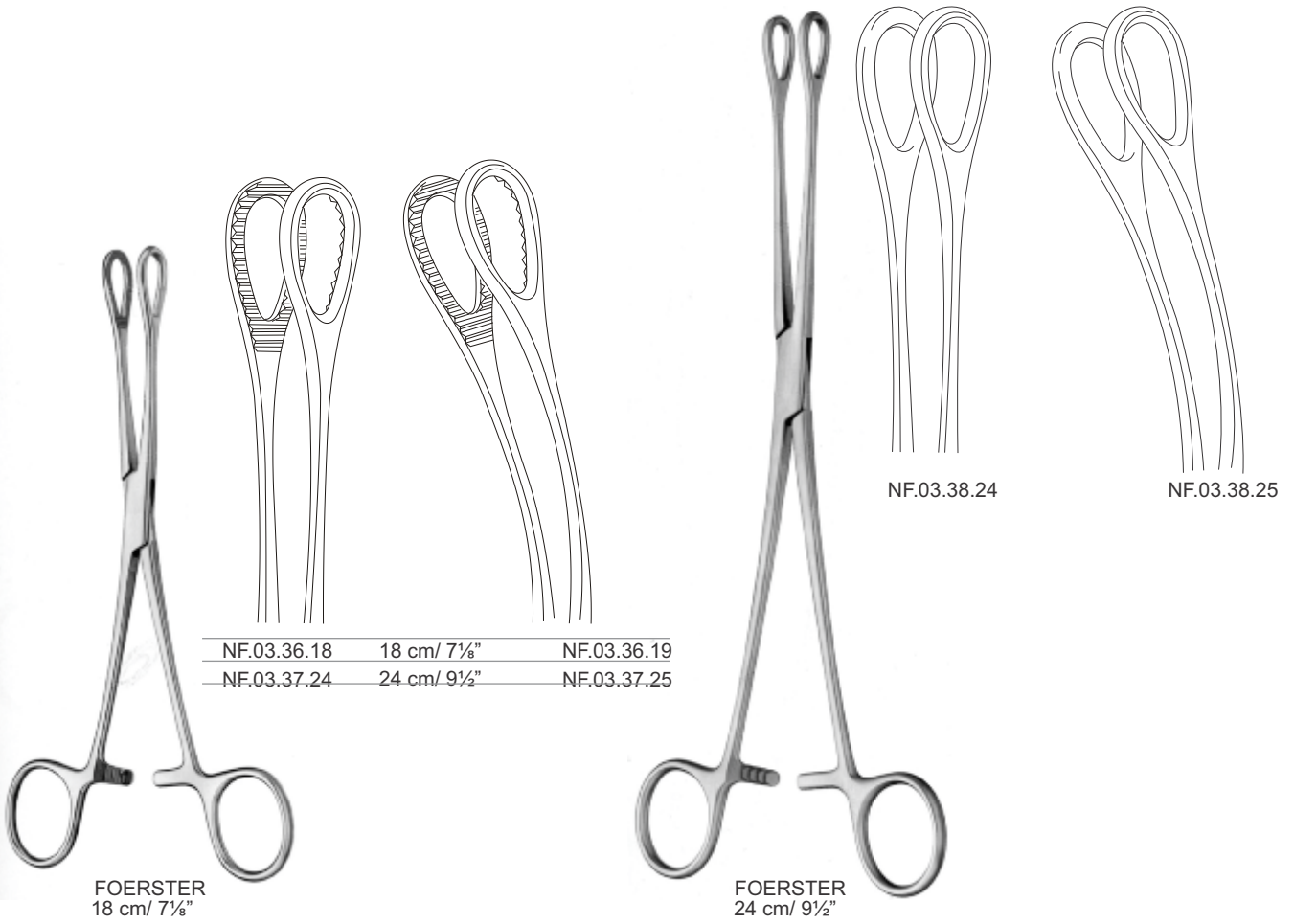

# Sponge Forceps



**BERGMANN-FOERSTER**  
NF.03.39.24  
24 cm/ 9½"

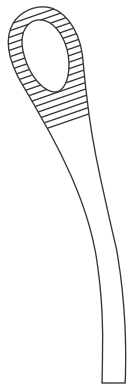

NF.03.40.24



**FLETCHER (JAVERTS)**  
NF.03.41.24  
24 cm/ 9½"

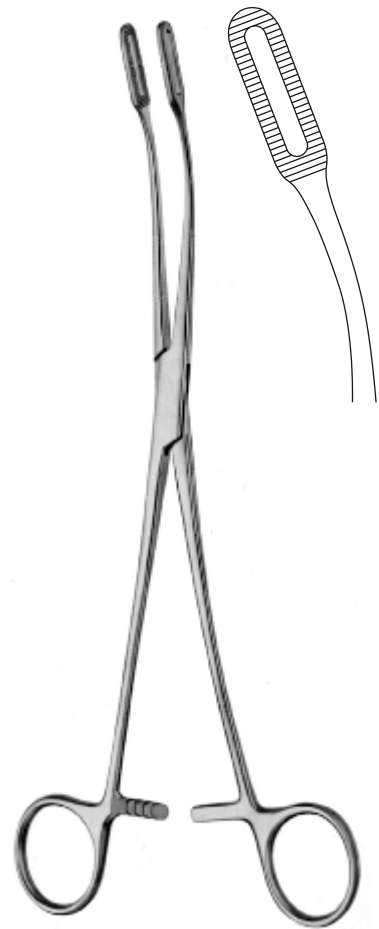

**FLETCHER (JAVERTS)**  
NF.03.42.24  
24 cm/ 9½"

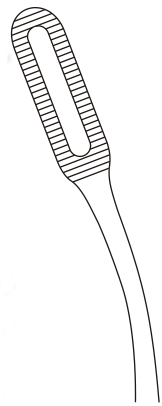

# Hemostatic Forceps



# Hemostatic Forceps

## Bulldog Clamps

NF.03.01.35 3.5 cm/ 1½"  
 NF.03.02.35 3.5 cm/ 1½"  
 NF.03.01.38 3.8 cm/ 1½"  
 NF.03.02.38 3.8 cm/ 1½"  
 NF.03.01.50 5 cm/ 2"  
 NF.03.02.50 5 cm/ 2"  
 NF.03.03.55 5.5 cm/ 2¼"  
 NF.03.04.55 5.5 cm/ 2¼"  
 NF.03.04.08 4.5 cm/ 1¾"  
 NF.03.04.12 5 cm/ 2"  
 NF.03.04.16 5.5 cm/ 2⅛"

**DIEFFENBACH** **DIETHRICH**

NF.03.04.28 4.5 cm/ 1¾"  
 NF.03.04.32 5 cm/ 2"  
 NF.03.04.36 5.5 cm/ 2⅛"

**DIETHRICH**

**DIETHRICH**

1/1

	NF.03.05.08	NF.03.05.10	NF.03.05.12	NF.03.05.18	NF.03.05.20	NF.03.05.22
Length	50 mm	50 mm	60 mm	50 mm	50 mm	60 mm
Jaws	8 mm	12 mm	20 mm	8 mm	12 mm	20 mm
Weight	3 gm	3 gm	3 gm	3 gm	3 gm	3 gm



# Hemostatic Forceps



**JOHNS-HOPKINS**  
NF.03.05.93  
24.5 cm / 9¾"

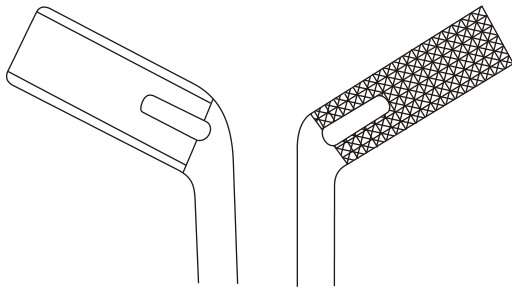

Applying forceps for Johns-Hopkins and Debaquey Bulldog clamps

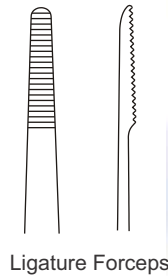
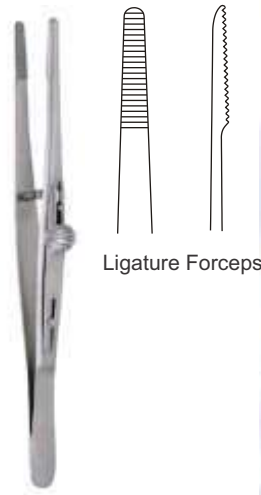

Ligature Forceps

**FRICKE**  
NF.03.05.94  
13 cm / 5½"



**OVERHOLT-MIXTER**  
NF.03.07.80  
21 cm / 8¼"

## Bulldog Clamps



**JOHNS-HOPKINS**

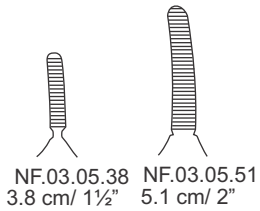

NF.03.05.38 3.8 cm / 1½"  
NF.03.05.51 5.1 cm / 2"



**JOHNS-HOPKINS**

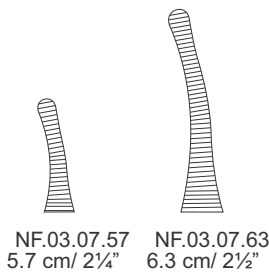

NF.03.07.57 5.7 cm / 2¼"  
NF.03.07.63 6.3 cm / 2½"



**JOHNS-HOPKINS**

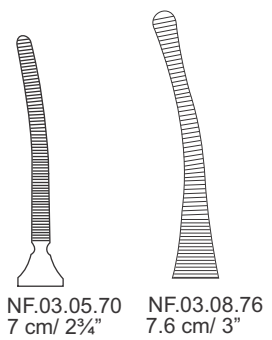

NF.03.05.70 7 cm / 2¾"  
NF.03.08.76 7.6 cm / 3"

# Hemostatic Forceps



**JOHNS-HOPKINS**  
NF.03.08.89  
8.9 cm / 3½"



**GREGORY "AT"**

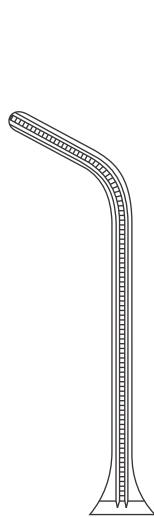

NF.03.09.91  
11 cm / 4¼"

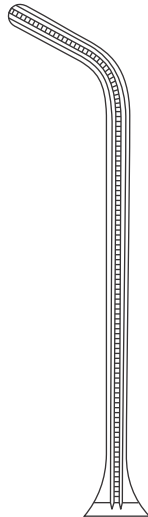

NF.03.09.92  
12 cm / 4¾"

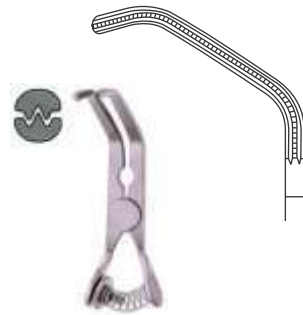

**DEBAKEY "AT"**  
NF.03.09.95  
6 cm / 2 3/5"



**GREGORY "AT"**  
11 cm / 4¼"

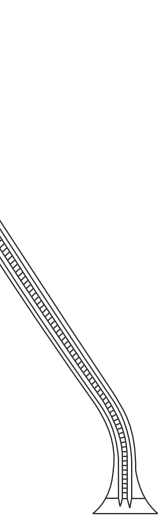

NF.03.09.93

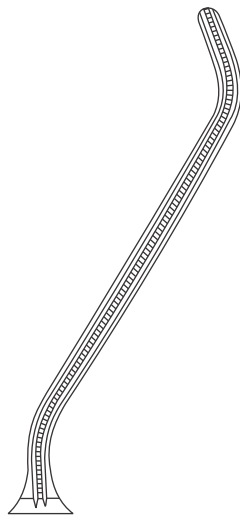

NF.03.09.94



**DEBAKEY "AT"**  
NF.03.09.96  
11.5 cm / 4½"



**DEBAKEY "AT"**  
NF.03.09.97  
8 cm / 3"

# Hemostatic Forceps



Vasectomy  
NF.03.10.51  
12.5 cm/ 5"  
Pointed



Vasectomy  
NF.03.10.52  
14 cm/ 5½"  
Ring Tip



HALSTED MOSQUITO

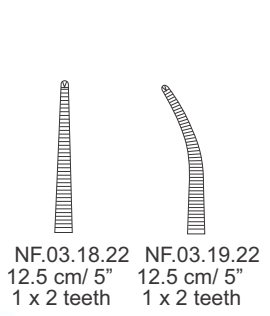
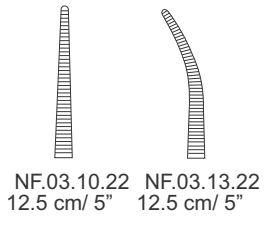
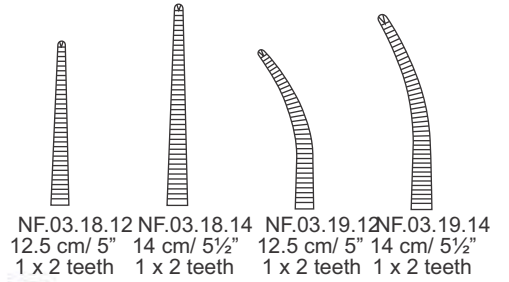
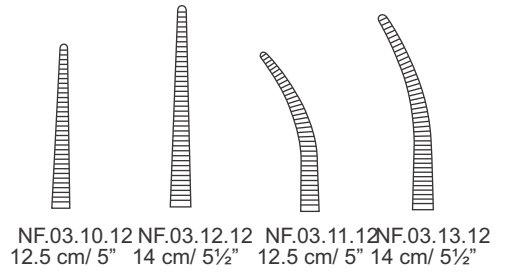

MICRO HALSTED MOSQUITO



10 cm/ 4"

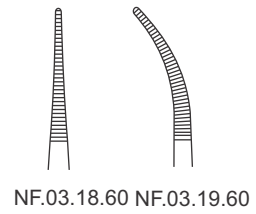

MOSQUITO "AT"  
12.5 cm/ 5"

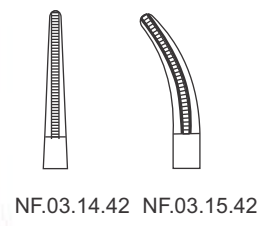

# Hemostatic Forceps



**PACKER (SKILLMAN)**  
12.5 cm / 5"



NF.03.14.82 NF.03.15.82

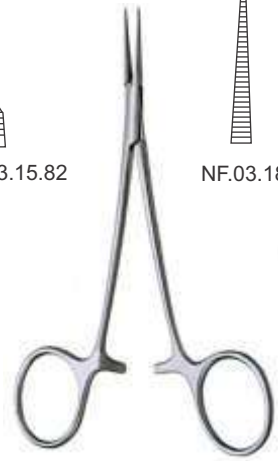

**MICRO JACOBSON**  
12.5 cm / 5"

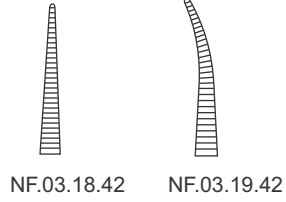

NF.03.18.42 NF.03.19.42



**MICRO JACOBSON  
(KOSHIMA)**  
12.5 cm / 5"

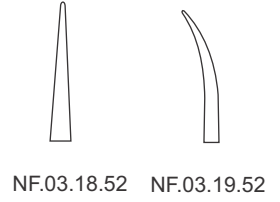

NF.03.18.52 NF.03.19.52



12.5 cm / 5"

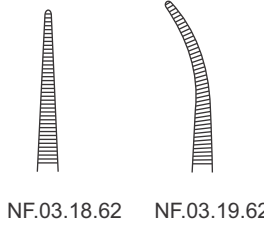

NF.03.18.62 NF.03.19.62



**CHAPUT**  
NF.03.20.13  
13 cm / 5 1/8"



**TUFFIER**  
NF.03.20.14  
13 cm / 5 1/8"

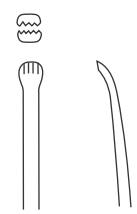

# Hemostatic Forceps



**CHAPUT**  
NF.03.20.23  
14 cm/ 5½"



**TERRIER**  
NF.03.21.13  
13 cm/ 5¼"



**TUFFIER**  
NF.03.22.13  
13 cm/ 5¼"

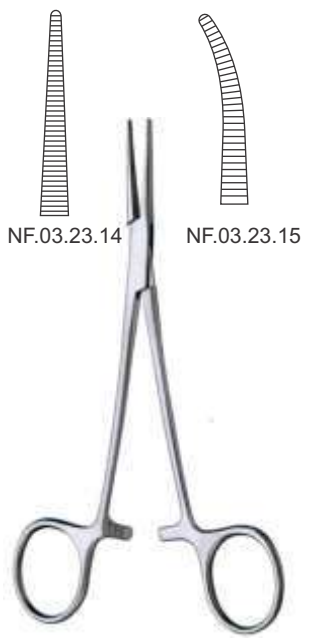

**CRILE BABY**  
14 cm/ 5½"



**DANDY BABY**  
NF.03.25.83  
13 cm/ 5¼"



**DANDY**  
14 cm/ 5½"

1 x 2 teeth

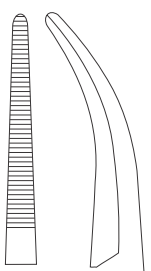

NF.03.25.84

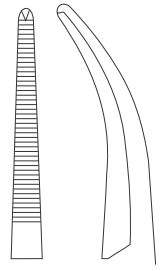

NF.03.25.94



**RAIMONDI**  
NF.03.25.97  
12.5 cm/ 5"

# Hemostatic Forceps



**HOEN**  
NF.03.25.98  
12.5 cm / 5"

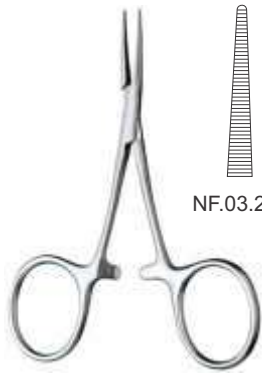

**CARREL (REYNOLDS)**  
11 cm / 4 1/4"

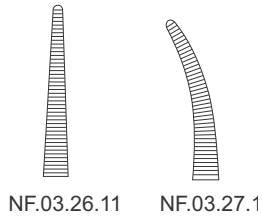

**HARTMANN  
(BABY-MOSQUITO)**  
10 cm / 4"

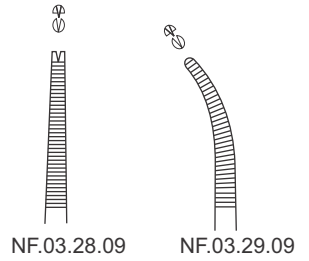

**PROVIDENCE HOSPITAL**  
14 cm / 5 1/2"

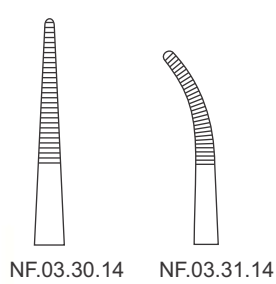

**PROVIDENCE HOSPITAL**  
14 cm / 5 1/2"

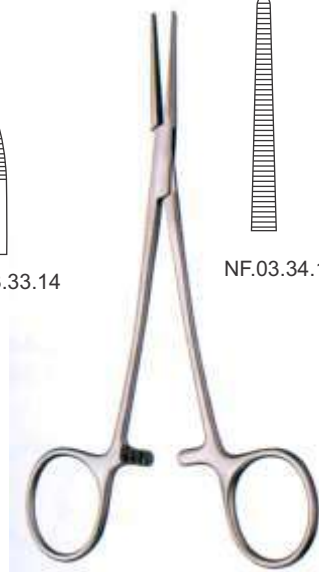
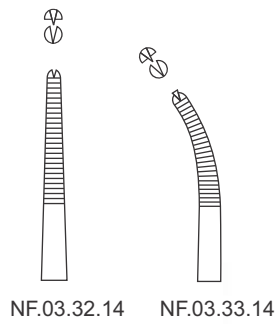

**LERICHE**  
15 cm / 6"

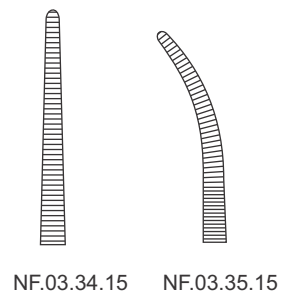

# Hemostatic Forceps

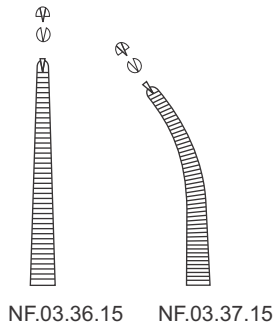

**LERICHE**  
15 cm / 6"

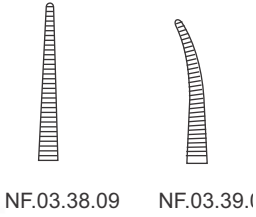

**MICRO HARTMANN**  
10 cm / 4"

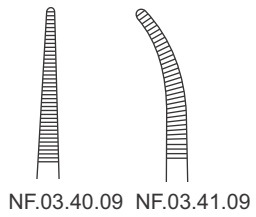

**HARTMANN (BABY-MOSQUITO)**  
10 cm / 4"

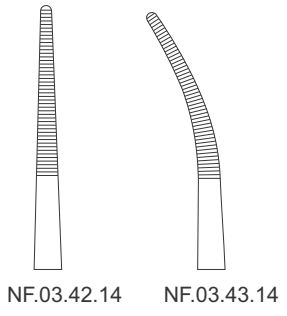

**KELLY**  
14 cm / 5½"

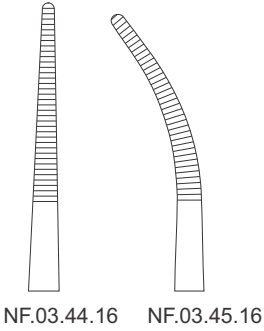
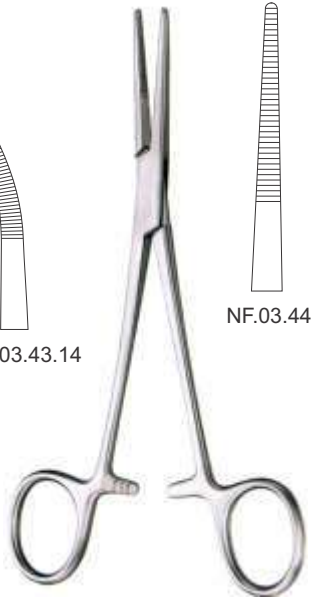

**RANKIN KELLY**  
16 cm / 6¼"

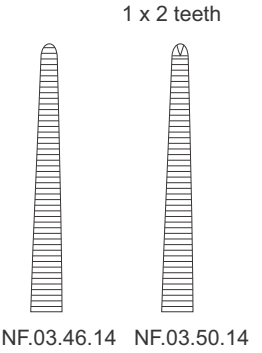

**CRILE**  
14 cm / 5½"

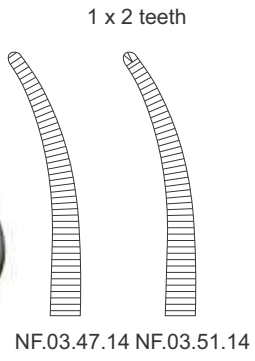

# Hemostatic Forceps

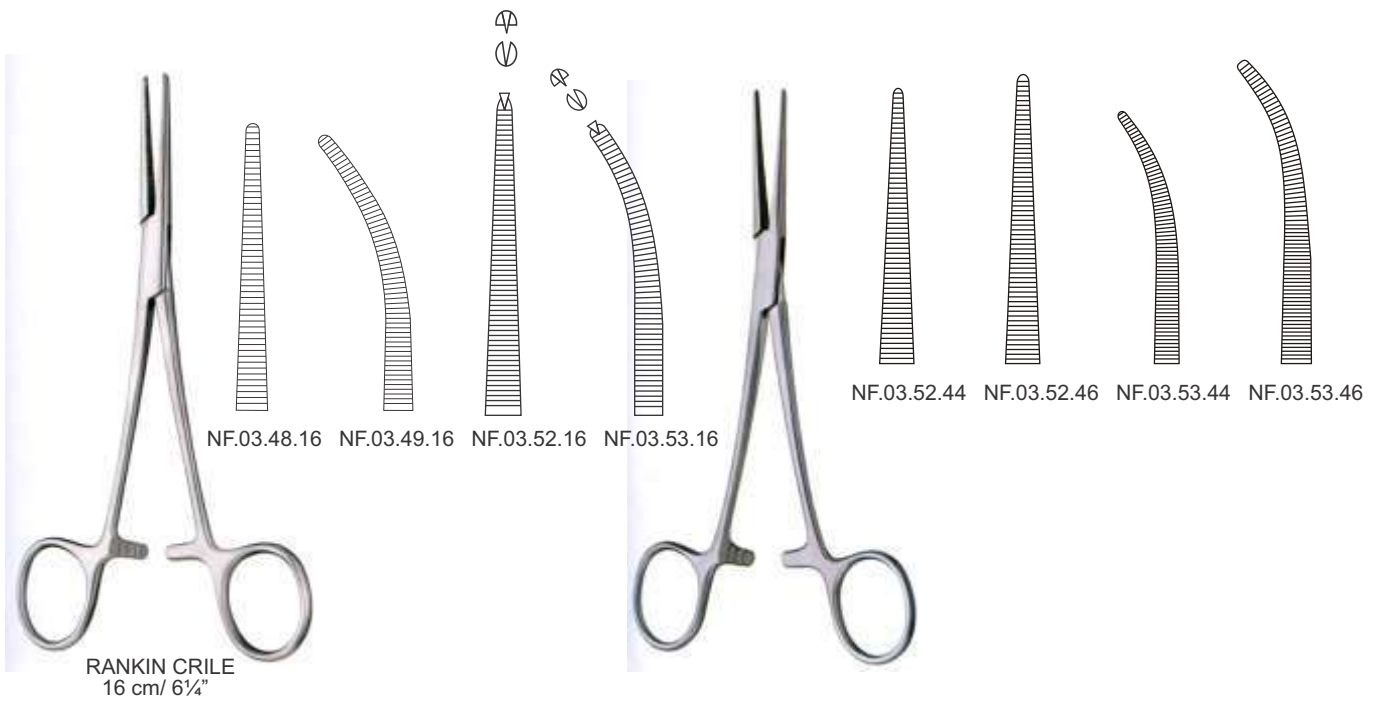

NF.03.48.16 NF.03.49.16 NF.03.52.16 NF.03.53.16

NF.03.52.44 NF.03.52.46 NF.03.53.44 NF.03.53.46

**RANKIN CRILE**  
16 cm/ 6 1/4"

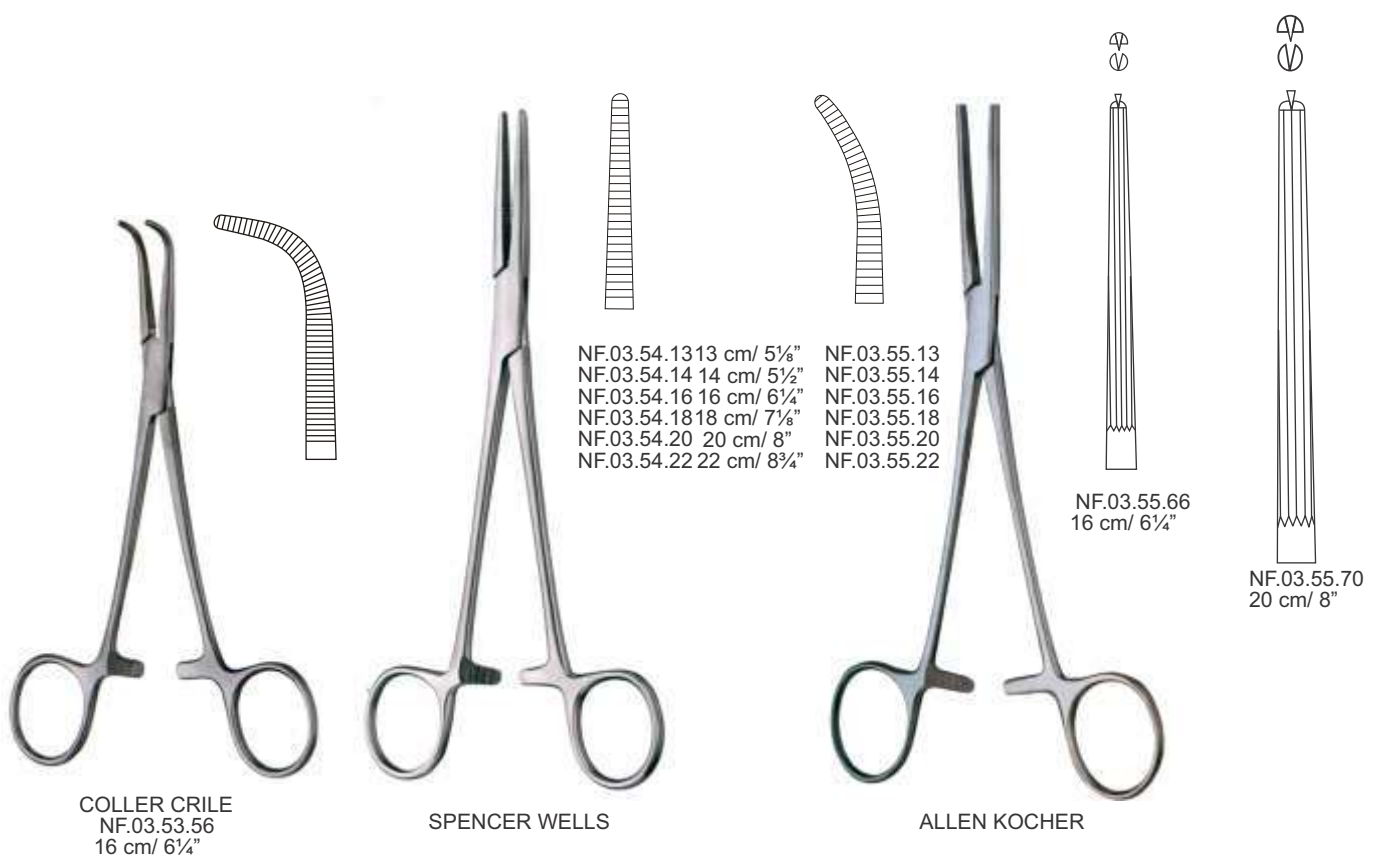

NF.03.54.13 13 cm/ 5 1/8"  
NF.03.54.14 14 cm/ 5 1/2"  
NF.03.54.16 16 cm/ 6 1/4"  
NF.03.54.18 18 cm/ 7 1/8"  
NF.03.54.20 20 cm/ 8"  
NF.03.54.22 22 cm/ 8 3/4"  
NF.03.55.13  
NF.03.55.14  
NF.03.55.16  
NF.03.55.18  
NF.03.55.20  
NF.03.55.22

NF.03.55.66  
16 cm/ 6 1/4"

NF.03.55.70  
20 cm/ 8"

**COLLER CRILE**  
NF.03.53.56  
16 cm/ 6 1/4"

**SPENCER WELLS**

**ALLEN KOCHER**



# Hemostatic Forceps



NF.03.56.1616 cm / 6¼"	NF.03.60.16
NF.03.56.1818 cm / 7⅛"	NF.03.60.18
NF.03.56.2020 cm / 8"	NF.03.60.20
NF.03.56.2222 cm / 8¾"	NF.03.60.22
NF.03.56.2424 cm / 9½"	NF.03.60.24
NF.03.56.2626 cm / 10¼"	NF.03.60.26

ROCHESTER PEAN

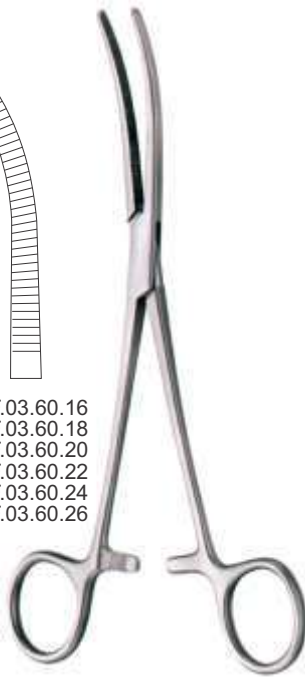

ROCHESTER PEAN



NF.03.57.14 14 cm / 5½"	NF.03.57.16 16 cm / 6¼"
----------------------------	----------------------------

PEAN



DEBAKEY PEAN "AT"

NF.03.59.50 20 cm / 8"	NF.03.60.50
NF.03.59.56.5 cm / 10½"	NF.03.60.56
NF.03.59.58 28 cm / 11"	NF.03.60.58



PEAN DIXON  
16 cm / 6¼"

NF.03.58.16	NF.03.58.17
-------------	-------------

# Hemostatic Forceps



**PEAN BABY**  
14 cm / 5½"

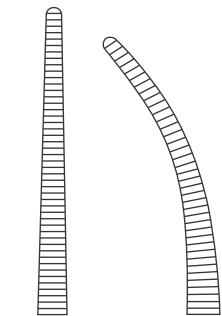

NF.03.59.11 NF.03.60.11

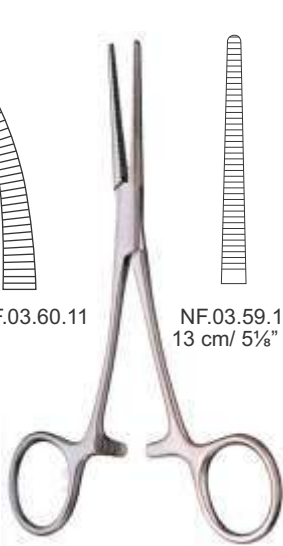

**PEAN**

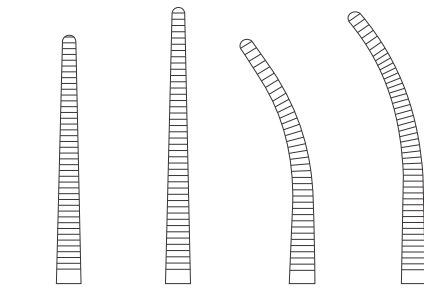

NF.03.59.13 NF.03.59.14 NF.03.60.13 NF.03.60.14  
13 cm / 5⅛" 14 cm / 5½" 13 cm / 5⅛" 14 cm / 5½"



**PEAN "AT"**  
14 cm / 5½"

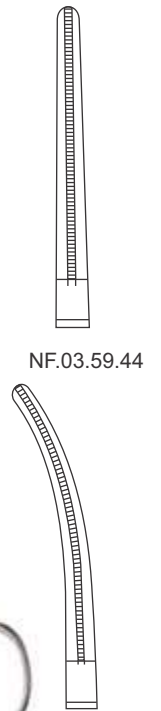

NF.03.59.44 NF.03.60.44



**ROCHESTER OCHSNER**

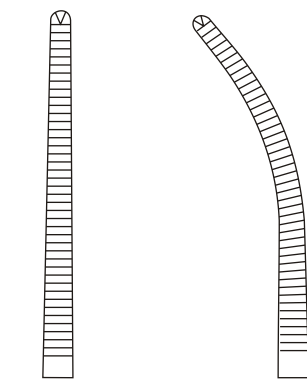

NF.03.62.16 16 cm / 6¼" NF.03.63.16  
NF.03.62.18 18 cm / 7⅞" NF.03.63.18  
NF.03.62.20 20 cm / 8" NF.03.63.20  
NF.03.62.22 22 cm / 8¾" NF.03.63.22  
NF.03.62.24 24 cm / 9½" NF.03.63.24  
NF.03.62.26 26 cm / 10¼" NF.03.63.26  
NF.03.62.30 30 cm / 12" NF.03.63.30



**ROCHESTER OCHSNER**



**PEAN**

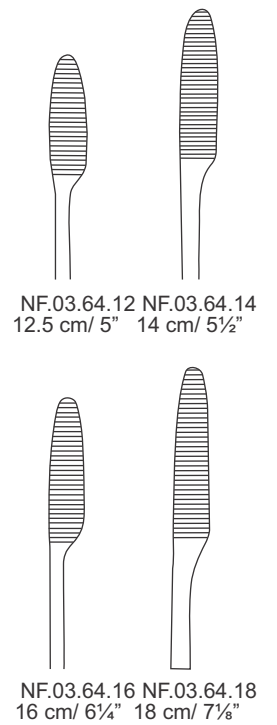

NF.03.64.12 12.5 cm / 5" NF.03.64.14 14 cm / 5½"  
NF.03.64.16 16 cm / 6¼" NF.03.64.18 18 cm / 7⅞"

# Hemostatic Forceps



BENGOLEA







NF.03.64.20 20 cm/ 8"	NF.03.64.21 20 cm/ 8"	NF.03.64.26 26 cm/ 10¼"	NF.03.64.23 23 cm/ 9"	NF.03.65.20 20 cm/ 8"	NF.03.65.21 20 cm/ 8"	NF.03.65.26 26 cm/ 10¼"	NF.03.65.23 23 cm/ 9"
	NF.03.64.22 23 cm/ 9"		NF.03.64.27 26 cm/ 10¼"		NF.03.65.23 23 cm/ 9"		NF.03.65.27 26 cm/ 10¼"
	NF.03.64.24 24.5 cm/ 9½"		NF.03.64.25 24.5 cm/ 9½"		NF.03.65.24 24.5 cm/ 9½"		NF.03.65.25 24.5 cm/ 9½"



BENGOLEA

NF.03.64.40 20 cm/ 8"	NF.03.64.41 20 cm/ 8"	NF.03.64.43 23 cm/ 9"	NF.03.64.44 23 cm/ 9"	NF.03.65.40 20 cm/ 8"	NF.03.65.41 20 cm/ 8"	NF.03.65.43 23 cm/ 9"	NF.03.65.44 23 cm/ 9"
			NF.03.64.47 26 cm/ 10¼"				NF.03.65.47 26 cm/ 10¼"

# Hemostatic Forceps

 <p>NF.03.65.12 12.5 cm / 5"</p> <p>NF.03.65.14 14 cm / 5½"</p>	 <p>NF.03.65.15 14 cm / 5½"</p>	 <p>NF.03.66.11</p> <p>NF.03.67.11</p>
<p>PEAN</p>	<p>PEAN NF.03.65.15 14 cm / 5½"</p>	<p>KOCHER BABY 14 cm / 5½"</p>
 <p>NF.03.66.13 13 cm / 5⅛"</p> <p>NF.03.66.14 14 cm / 5½"</p> <p>NF.03.67.13 13 cm / 5⅛"</p> <p>NF.03.67.14 14 cm / 5½"</p>	 <p>NF.03.67.42 22 cm / 8¾"</p> <p>NF.03.67.52 22 cm / 8¾"</p> <p>NF.03.67.45 25 cm / 10"</p> <p>NF.03.67.55 25 cm / 10"</p>	 <p>NF.03.68.08 18 cm / 7⅛"</p> <p>NF.03.68.10 20 cm / 8"</p> <p>NF.03.68.14 24 cm / 9½"</p>
<p>KOCHER</p>	<p>ROBERTS</p>	<p>OLIVECRONA (GRAFOORD)</p>

# Hemostatic Forceps



**ZENKER**  
29.5 cm / 11½"



NF.03.68.28

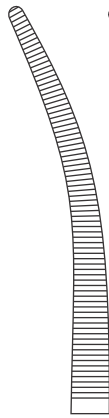

NF.03.68.29

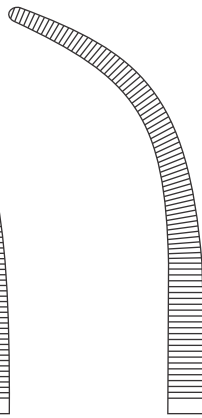

NF.03.68.30



**SAROT**  
24 cm / 9½"



NF.03.68.74

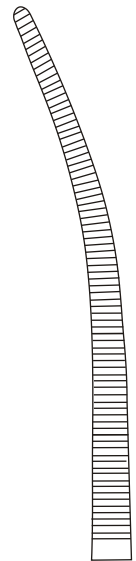

NF.03.68.75



**CRAFOORD SELLORS**  
24 cm / 9½"

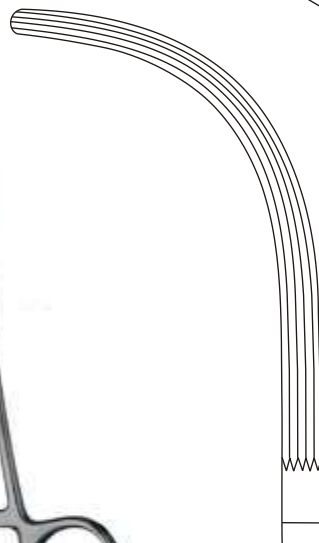

NF.03.68.82

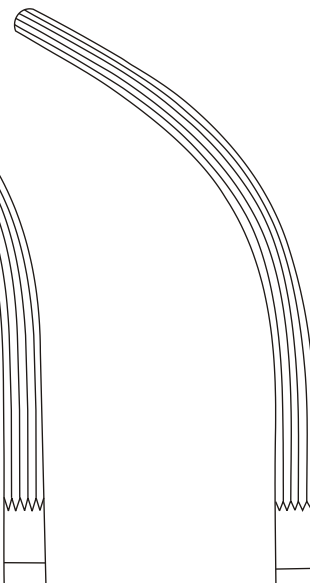

NF.03.68.83

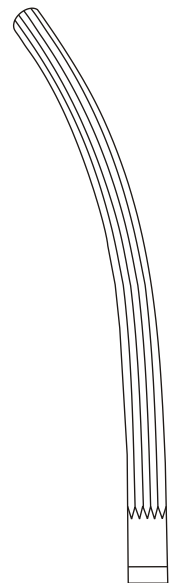

NF.03.68.84

# Hemostatic Forceps

**RUMEL**  
23 cm/ 9"

NF.03.69.01    NF.03.69.02    NF.03.69.03    NF.03.69.04    NF.03.69.05

**CRAFOORD (COLLER)**  
NF.03.69.18 18 cm/ 7 1/8"  
NF.03.69.20 20 cm/ 8"  
NF.03.69.24 24 cm/ 9 1/2"

**DIXON LOVELACE**  
16 cm/ 6 1/4"

**LOVELACE**  
NF.03.69.85  
15 cm/ 6"

**DIXON LOVELACE**  
NF.03.69.86  
16 cm/ 6 1/4"

# Hemostatic Forceps



**OCHSNER DIXON**  
16 cm / 6¼"

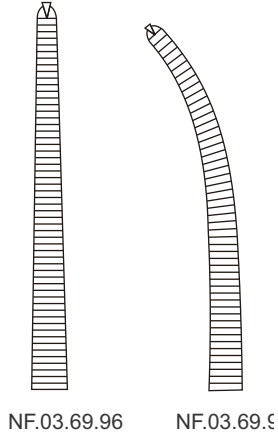

NF.03.69.96      NF.03.69.9



**KOCHER**  
NF.03.70.14  
14 cm / 5½"

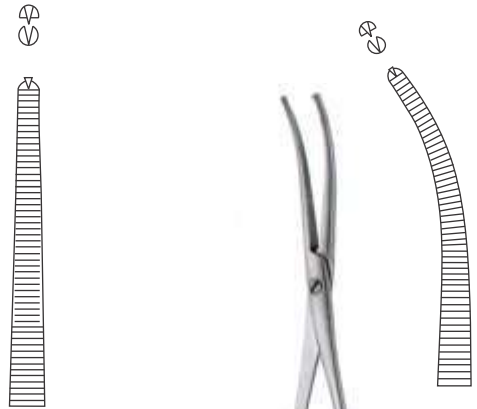

**KOCHER**  
NF.03.74.14  
14 cm / 5½"

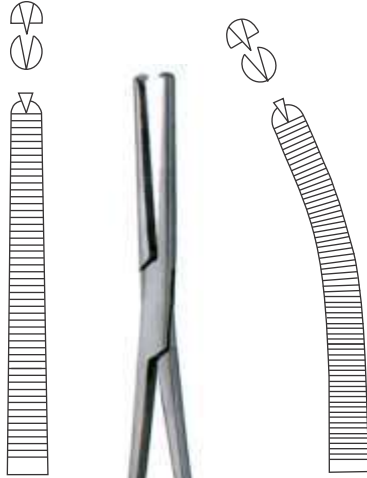

NF.03.72.33      NF.03.72.34



**HOLZBACH**  
23.5 cm / 9¼"

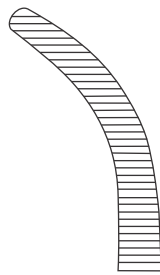

NF.03.73.23  
23 cm / 9"

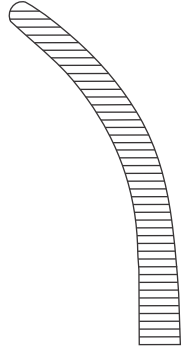

NF.03.73.24  
24 cm / 9½"



**MOYNIHAN**

# Hemostatic Forceps

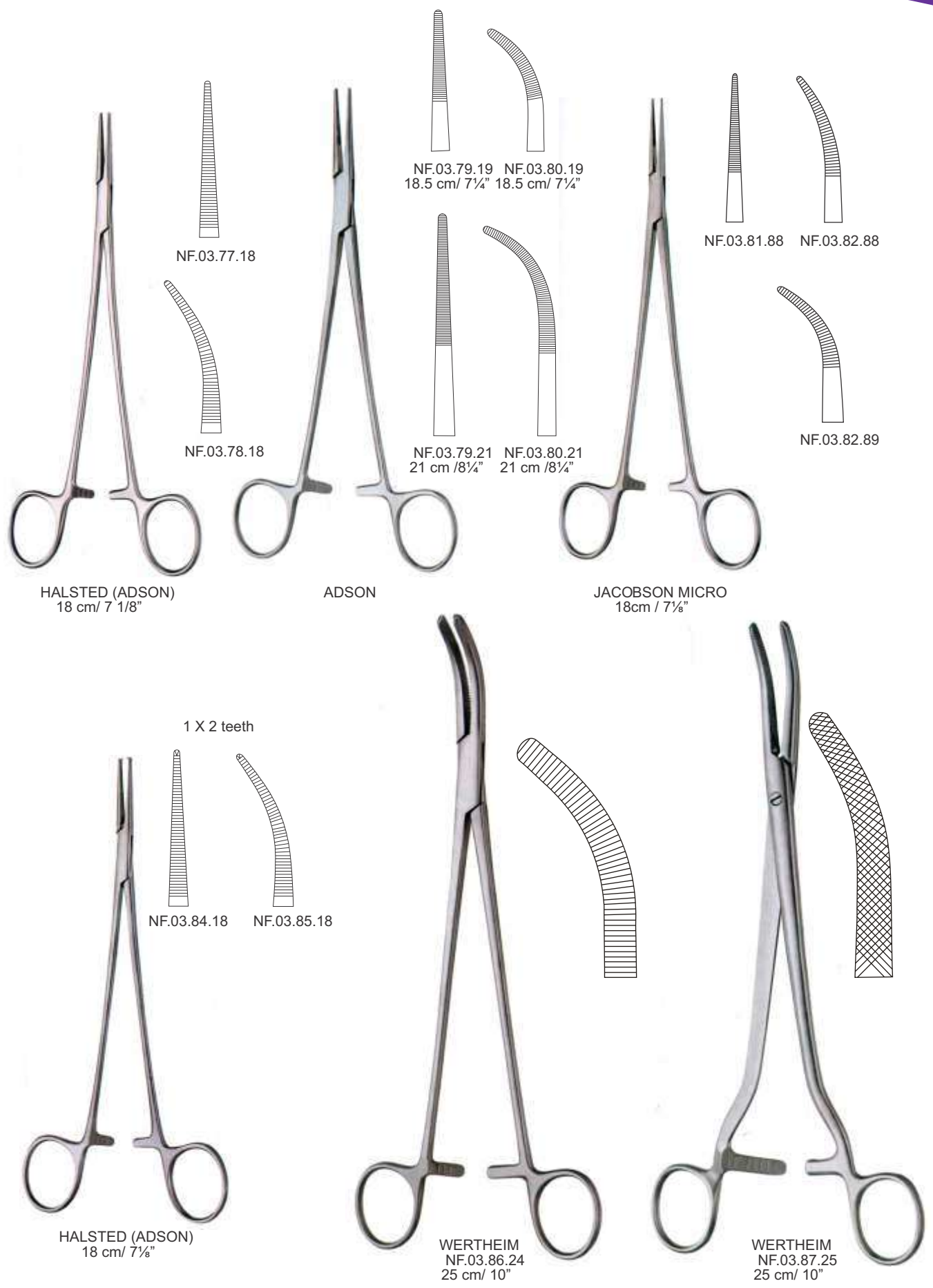



# Hemostatic Forceps



WERTHEIM  
NF.03.88.43  
23 cm / 9"



NF.03.89.16 16 cm / 6¼"  
NF.03.89.20 20 cm / 8"  
NF.03.89.23 23 cm / 9"



NF.03.90.16  
NF.03.90.20  
NF.03.90.23



HARRINGTON  
NF.03.90.27  
27 cm / 10¾"



FERGUSON  
16.5 cm / 6½"

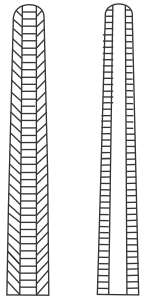

NF.03.91.16

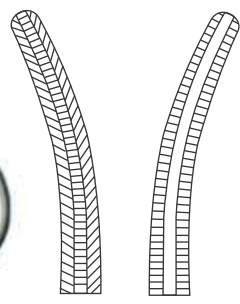

NF.03.91.19



PHANEUF  
21 cm / 8¼"



NF.03.91.21

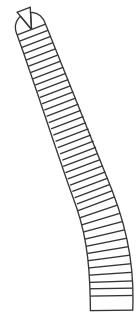

NF.03.92.21

# Hemostatic Forceps

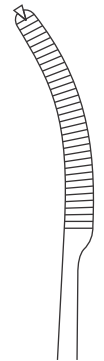
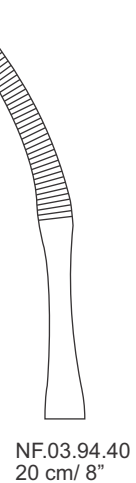
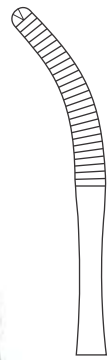
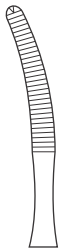
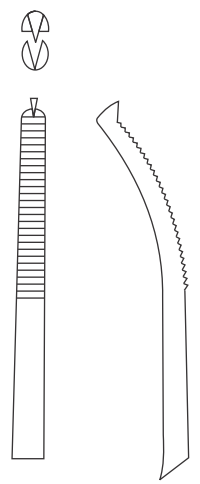
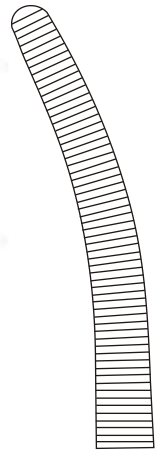
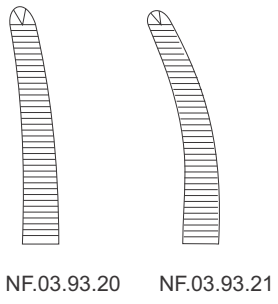

# Hemostatic Forceps



MIKULICZ  
20 cm / 8"

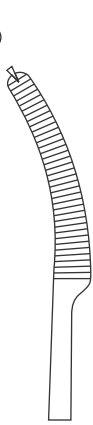

NF.03.94.60

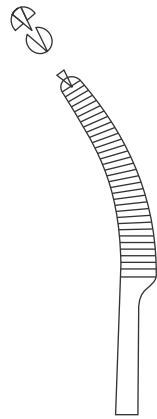

NF.03.94.61



MIKULICZ  
20 cm / 8"

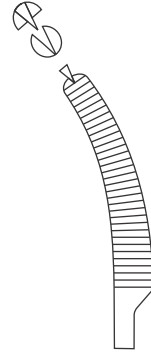

NF.03.94.70



WERTHEIM "AT"

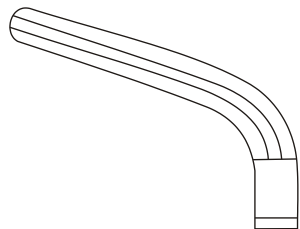

NF.03.94.35  
19.5 cm / 7 3/4"

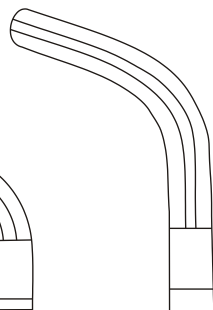

NF.03.94.34  
20.5 cm / 8"

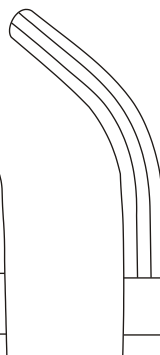

NF.03.94.33  
21.5 cm / 8 1/2"

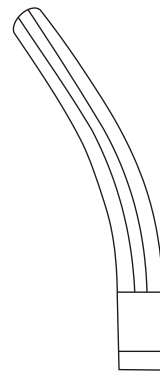

NF.03.94.31  
22 cm / 8 3/4"



NF.03.94.30  
22 cm / 8 3/4"

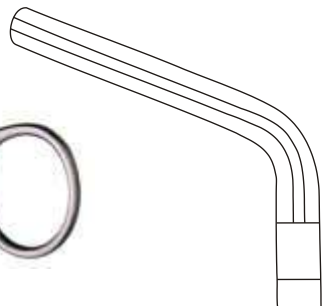

NF.03.94.55  
23 cm / 9"

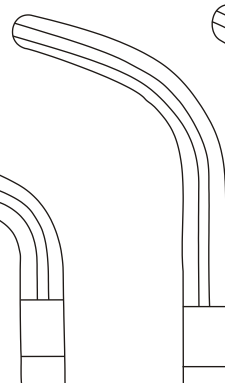

NF.03.94.54  
23.5 cm / 9 1/4"

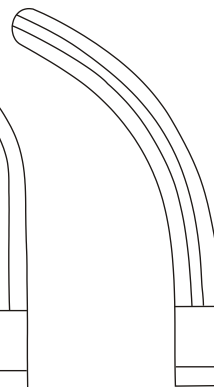

NF.03.9453  
24 cm / 9 1/2"

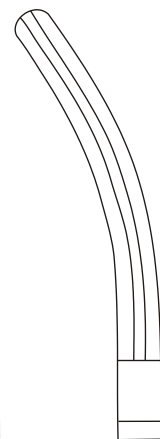

NF.03.94.51  
24.5 cm / 9 3/4"



NF.03.94.50  
25 cm / 10"

# Hemostatic Forceps



# Hemostatic Forceps



OVERHOLT BABY  
NF.03.99.13  
13.5 cm / 5¼"



FUCHSIG  
NF.03.99.19  
19 cm / 7½"



MEEKER  
NF.03.99.27  
27 cm / 10¾"



OVERHOLT SLIM

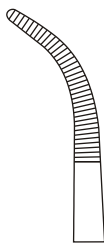

NF.03.99.28  
18.5 cm / 7¼"

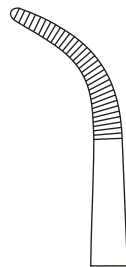

NF.03.99.30  
20.5 cm / 8"

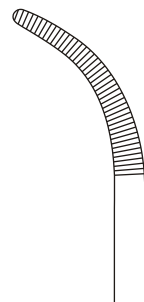

NF.03.99.31  
21 cm / 8¼"

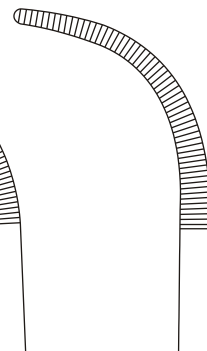

NF.03.99.32  
21.5 cm / 8½"

# Hemostatic Forceps



NF.03.99.49  
19 cm / 7½"

OVERHOLT  
GEISSENDOERFER

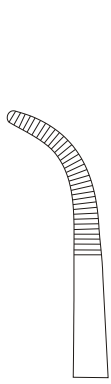

NF.03.99.49  
19 cm / 7½"

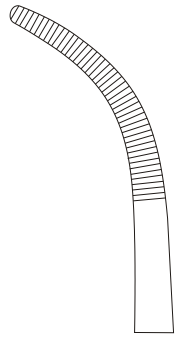

NF.03.99.51  
21.5 cm / 8½"

NF.03.99.67  
27 cm / 10¾"

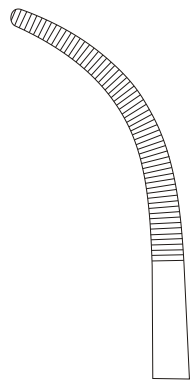

NF.03.99.52  
22.5 cm / 9"

NF.03.99.68  
28 cm / 11"

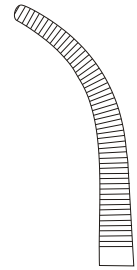

NF.03.99.60  
20.5 cm / 8¼"

NF.03.99.76  
26 cm / 10¼"

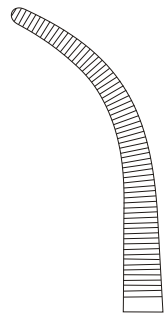

NF.03.99.61  
21 cm / 8¼"

NF.03.99.77  
27 cm / 10¾"

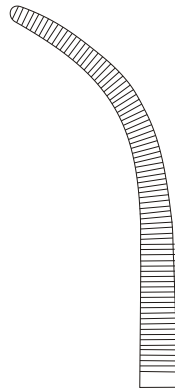

NF.03.99.62  
22.5 cm / 9"

NF.03.99.78  
27.5 cm / 10¾"

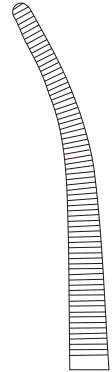

NF.03.99.63  
23.5 cm / 9¼"

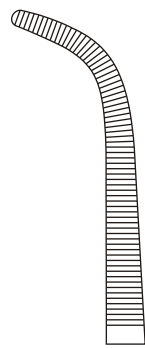

NF.03.99.64

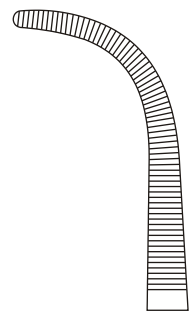

NF.03.99.65



OVERHOLT MIOTTI  
24 cm / 9½"

# Hemostatic Forceps

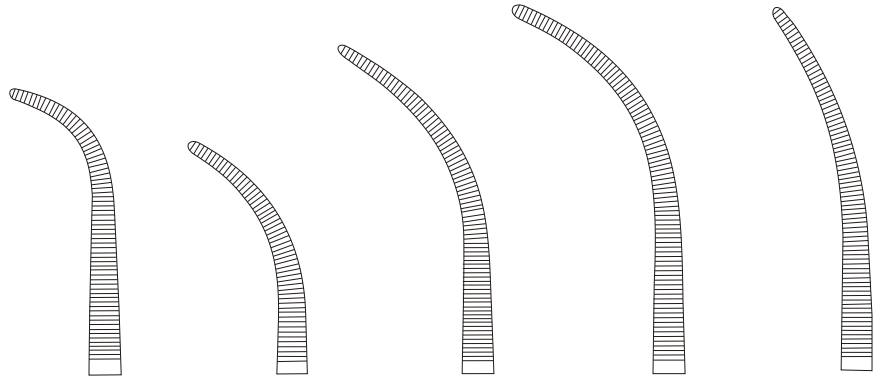

NF.03.99.82  
22 cm / 8¾"

NF.03.99.83  
21.5 cm / 8½"

NF.03.99.84  
22.5 cm / 8¾"

NF.03.99.85  
23 cm / 9"

NF.03.99.86  
23 cm / 9"



OVERHOLT  
delicate pattern

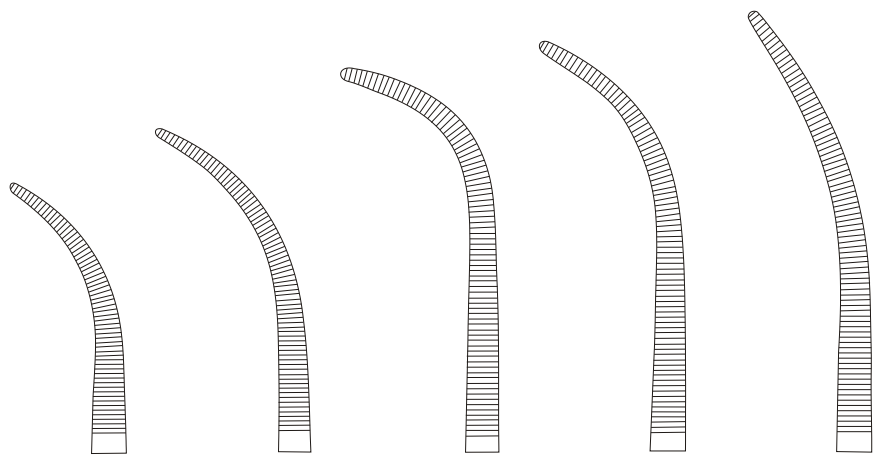

NF.03.99.87  
26.5 cm / 10½"

NF.03.99.88  
27.5 cm / 10¾"

NF.03.99.89  
30 cm / 11¾"

NF.03.99.90  
30 cm / 11¾"

NF.03.99.91  
30.5 cm / 12"

# Dissecting Forceps

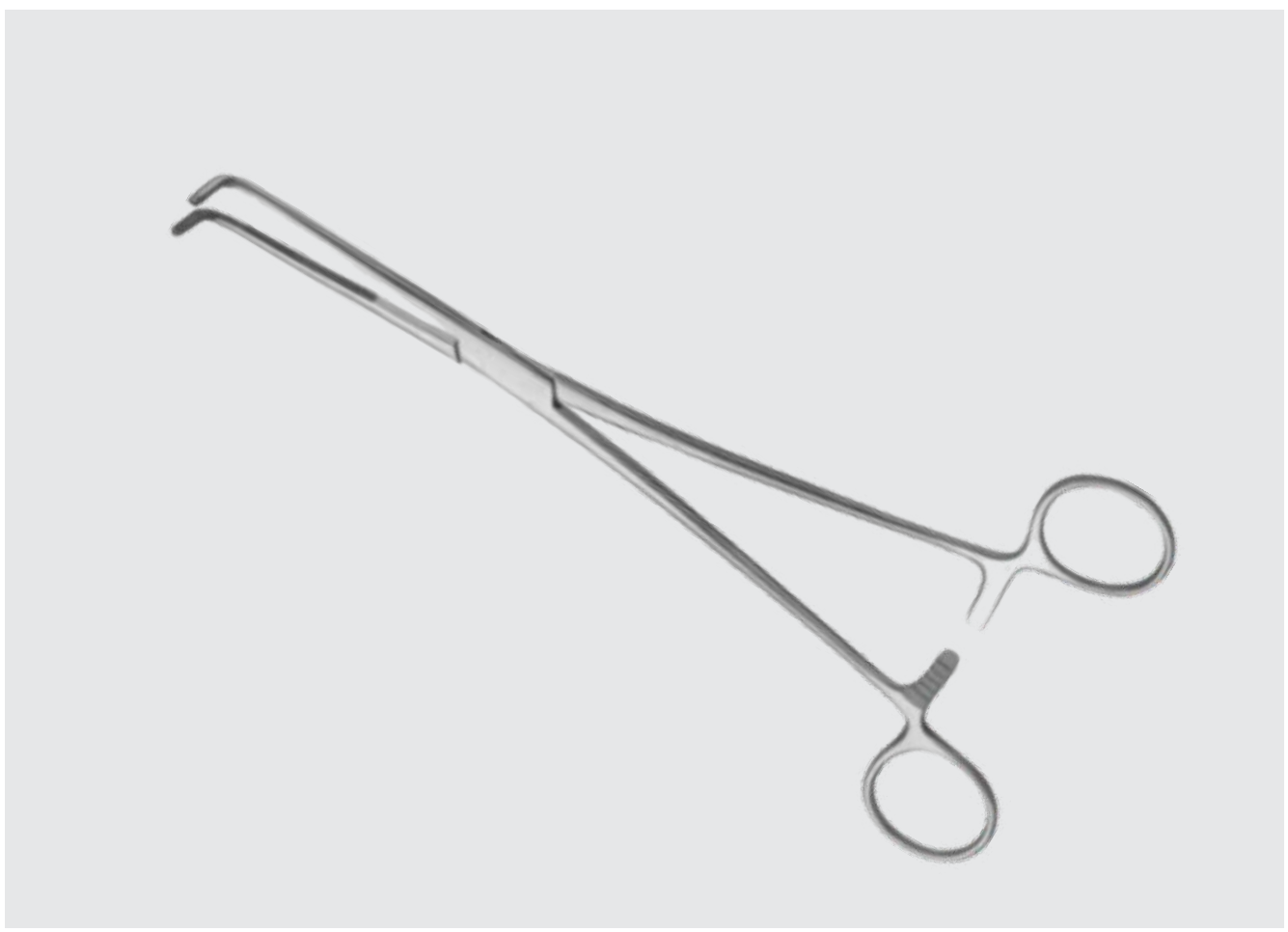



# Dissecting Forceps



NF.03.01.14 14 cm / 5½"  
NF.03.02.19 19 cm / 7½"

NF.03.03.14 14 cm / 5½"  
NF.03.04.19 19 cm / 7½"

ADSON BABY

MIXTER BABY

NF.03.05.14  
14 cm / 5½"



NF.03.05.89  
19 cm / 7½"

MIXTER

ROCHESTER MIXTER

NF.03.06.18 18 cm / 7¼"  
NF.03.06.23 23 cm / 9"

NF.03.06.36  
16 cm / 6¼"

NF.03.06.40  
20 cm / 8"

# Dissecting Forceps



**JOHNS HOPKINS**  
NF.03.06.45  
20 cm / 8"

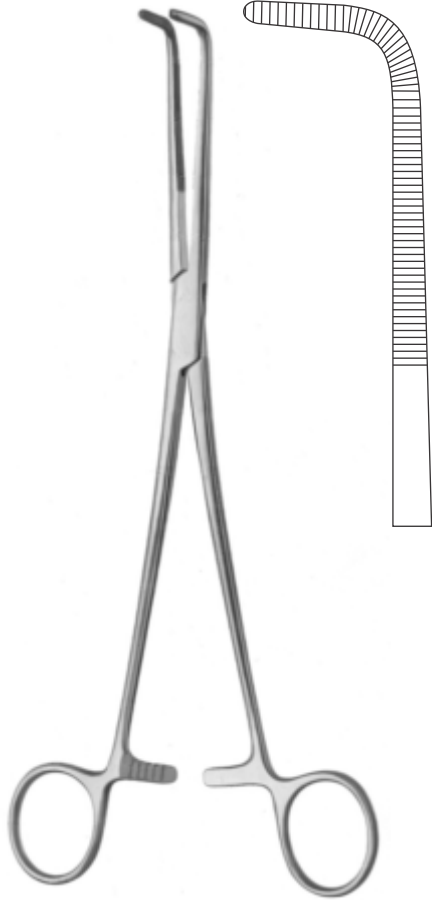

**MIXTER CRAFOORD**  
NF.03.07.75 25 cm / 10"  
NF.03.07.76 15 cm / 6"  
NF.03.07.77 27 cm / 10 3/4"  
NF.03.07.78 18 cm / 7 1/8"  
NF.03.07.80 20 cm / 8"



**WIKSTROEM**  
NF.03.07.81 21 cm / 8 1/4"  
NF.03.07.83 23 cm / 9"  
NF.03.07.84 24 cm / 9 1/2"



**GEMINI**

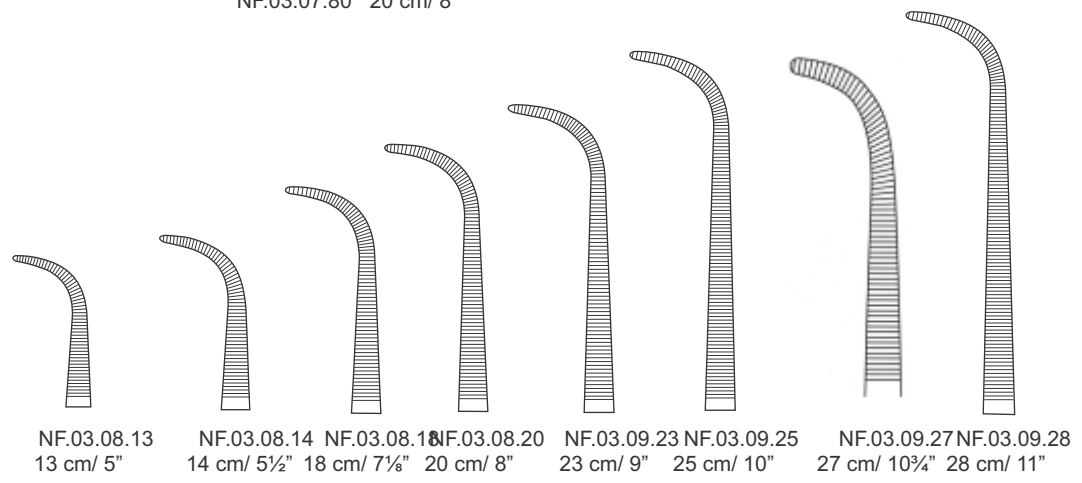

NF.03.08.13 13 cm / 5"    NF.03.08.14 14 cm / 5 1/2"    NF.03.08.15 18 cm / 7 1/8"    NF.03.08.20 20 cm / 8"    NF.03.09.23 23 cm / 9"    NF.03.09.25 25 cm / 10"    NF.03.09.27 27 cm / 10 3/4"    NF.03.09.28 28 cm / 11"

# Dissecting Forceps



NF.03.10.50  
SCHNIDT  
(BOETTCHER)

19 cm / 7½"

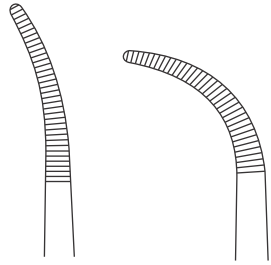

NF.03.10.55  
SCHNIDT  
(SAWTELL)



NF.03.11.51  
SCHNIDT  
(BOETTCHER)

19 cm / 7½"

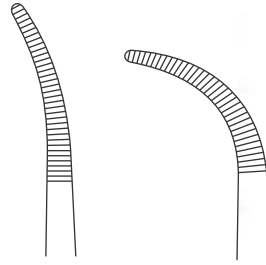

NF.03.11.56  
SCHNIDT  
(SAWTELL)



LAHEY (SWEET)  
NF.03.12.09  
19 cm / 7½"

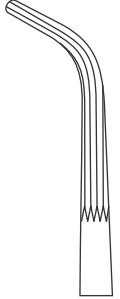

LAHEY

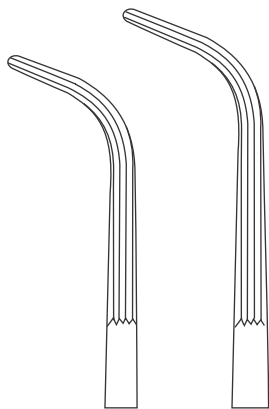

NF.03.12.19  
19 cm / 7½"

NF.03.12.23  
23 cm / 9"



HOHENFELLNER

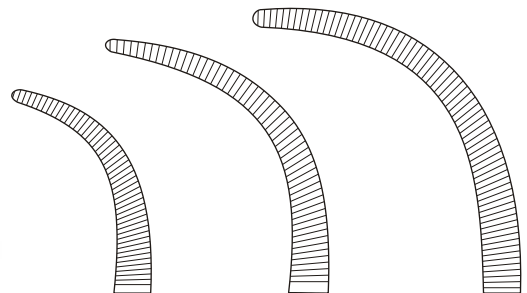

NF.03.12.78  
18 cm / 7 ⅛"

NF.03.12.81  
21 cm / 8¼"

NF.03.12.84  
24 cm / 9½"

# Dissecting Forceps



O'SHAUGNESSY  
NF.03.12.50  
20 cm / 8"

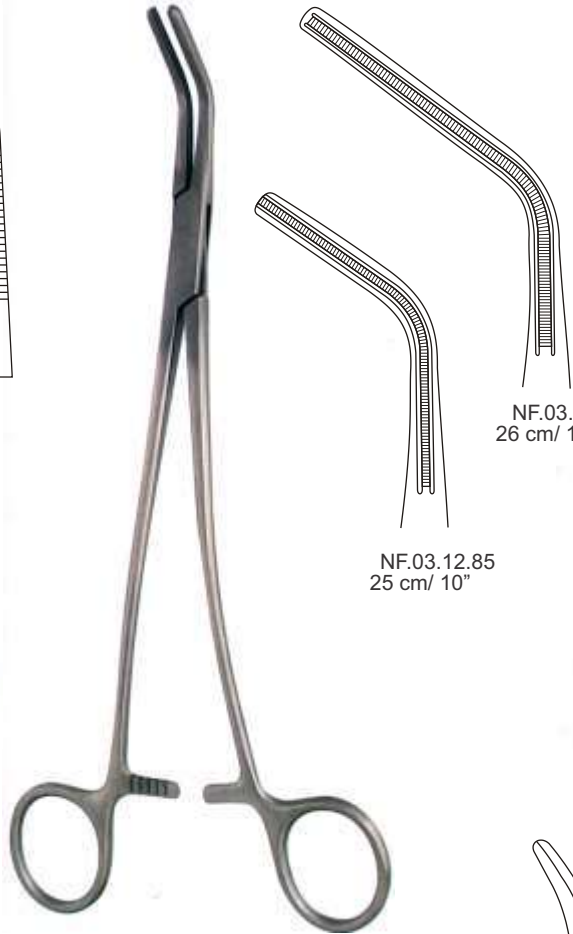

HOHENFELLNER "AT"

NF.03.12.85  
25 cm / 10"

NF.03.12.86  
26 cm / 10 1/4"



DEBAKEY MIXTER  
NF.03.13.35  
20 cm / 8"



MIXTER

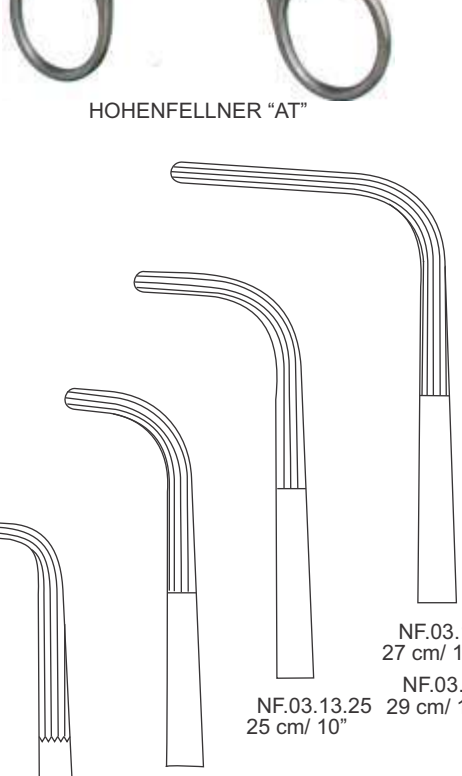

NF.03.13.19 19 cm / 7 1/2"    NF.03.13.22 22 cm / 8 3/4"

NF.03.13.25 25 cm / 10"

NF.03.13.27 27 cm / 10 3/4"

NF.03.13.29 29 cm / 11 1/2"



BRUNSCHWIG  
NF.03.13.52  
22 cm / 8 3/4"

# Dissecting Forceps

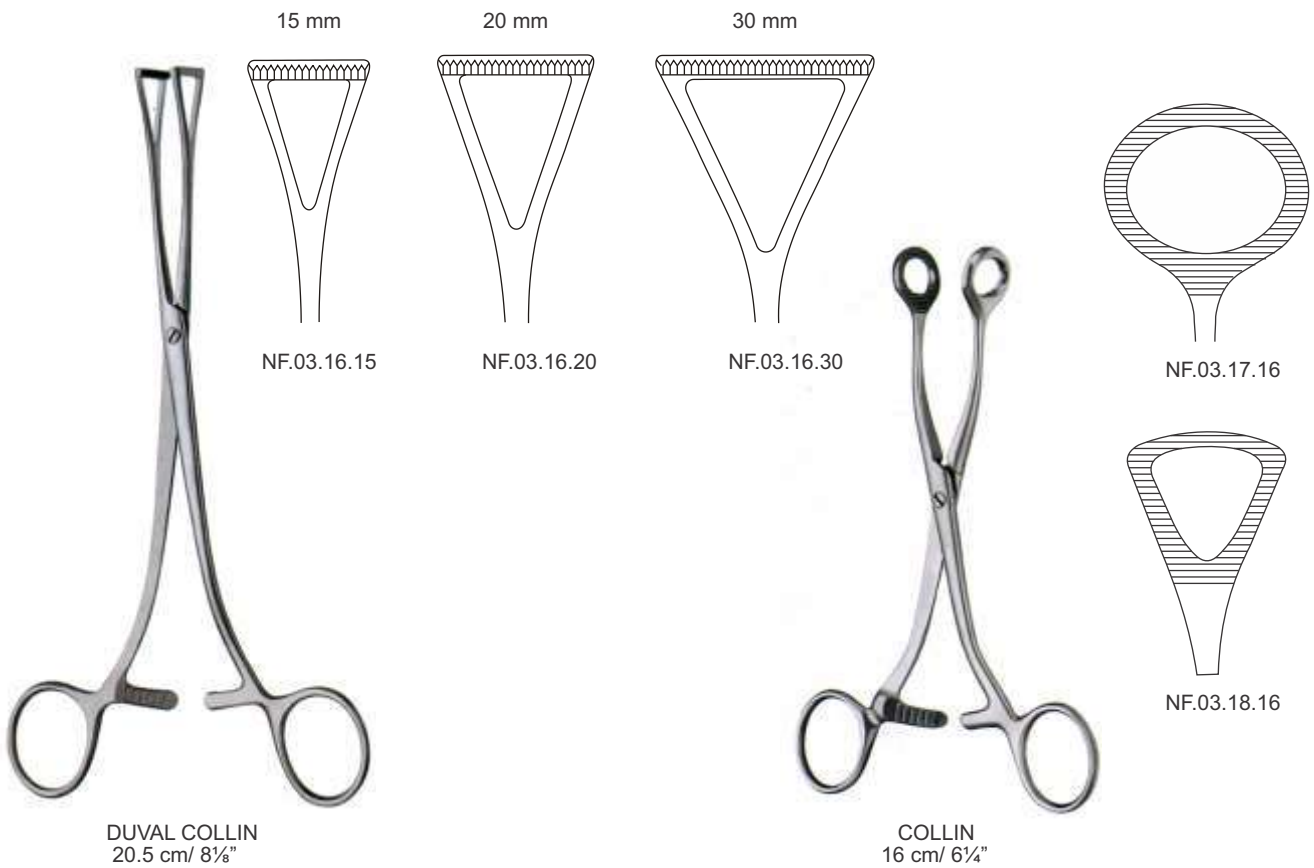
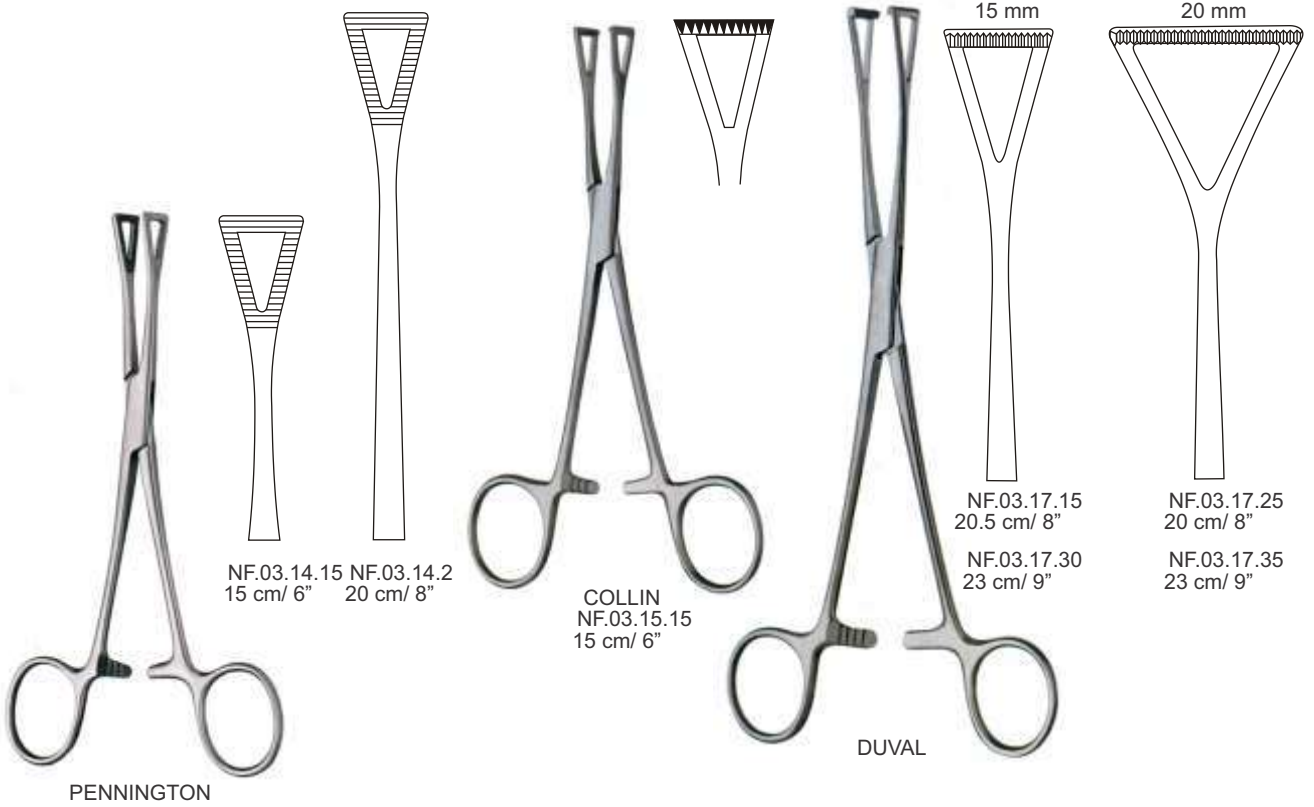

# Dissecting Forceps

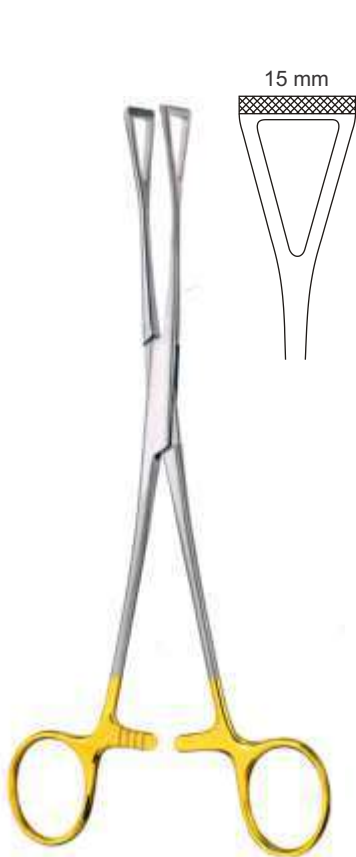

DUVAL "TC"  
NF.03.17.46  
20 cm / 8"



DUVAL "AT"  
NF.03.17.82  
23 cm / 9"

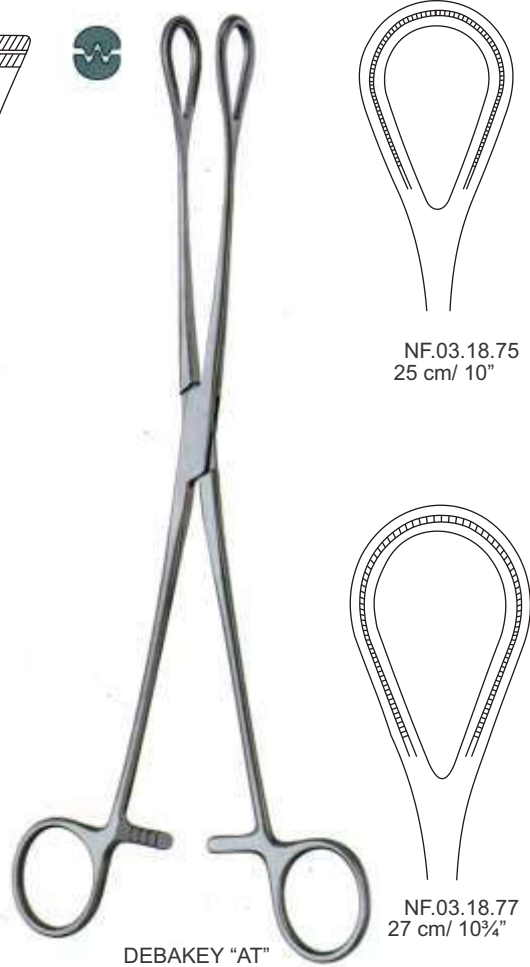

DEBAKEY "AT"

# Dissecting Forceps



NF.03.19.05  
5.5 cm/ 2 1/4"



JONES  
NF.03.20.08  
8 cm/ 3"

NF.03.20.09  
9 cm/ 3 1/2"



SCHAEFFEL  
NF.03.21.08  
8 cm/ 3"

NF.03.21.09  
9 cm/ 3 1/2"



NF.03.22.08  
8cm/ 3"



DOYEN  
NF.03.24.18  
18 cm/ 7 1/8"



BACKHAUS  
NF.03.25.08 8.5 cm/ 3 1/4"  
NF.03.25.10 10.5 cm/ 4 1/8"  
NF.03.26.13 13 cm/ 5 1/8"  
NF.03.26.15 15 cm/ 6"



TOHOKU  
NF.03.27.10 10 cm/ 4"  
NF.03.27.13 13 cm/ 5"



BERNHARD (STAUDE)  
NF.03.27.16  
16 cm/ 6 1/4"



BACKHAUS ROEDER  
NF.03.28.13 13 cm/ 5 1/8"  
NF.03.28.15 15 cm/ 6"

# Dissecting Forceps



**OMBREDANNE (JACKSON)**  
NF.03.29.13  
13.5 cm / 5¼"

**Nawrooz**  
NF.03.29.14  
13 cm / 5½"

**EDNA (LORNA)**  
NF.03.30.10  
10 cm / 4"

**EDNA (LORNA)**  
NF.03.30.34  
14 cm / 5½"



**BALL & SOCKET**  
NF.03.30.11 11 cm / 4¼"  
NF.03.30.13 13 cm / 5½"  
NF.03.30.15 15 cm / 6"



**LANE**  
NF.03.33.15 15 cm / 6"  
NF.03.33.18 18 cm / 7½"  
NF.03.33.20 20 cm / 8"



NF.03.36.14  
14.5 cm / 5¾"



# Dissecting Forceps

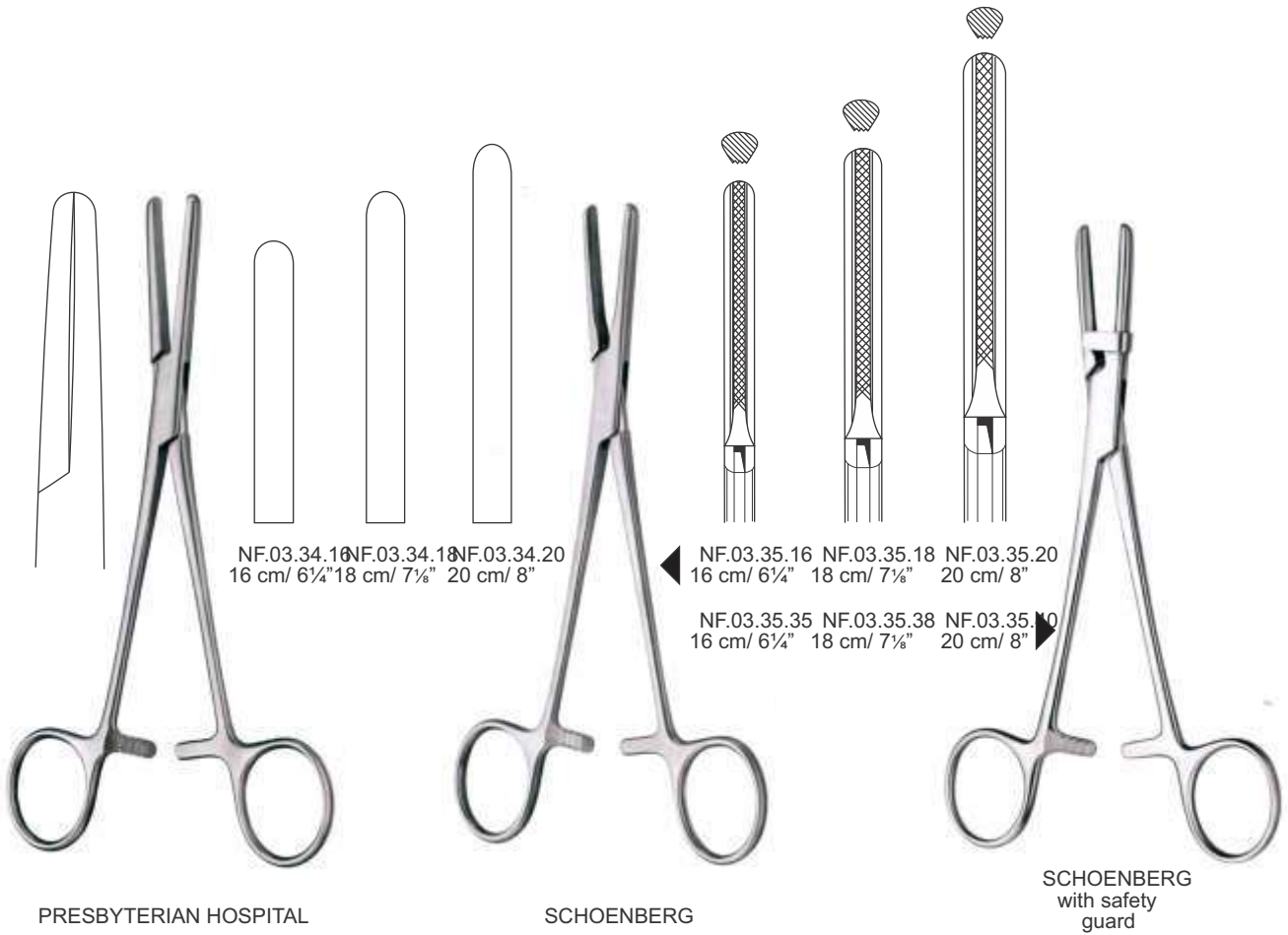

# Needle Holders



# Needle Holders

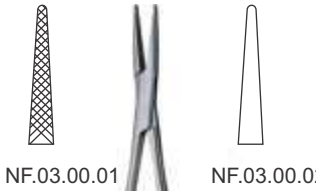

NF.03.00.01

NF.03.00.0



**HALSTED**  
11.5 cm/ 4½"

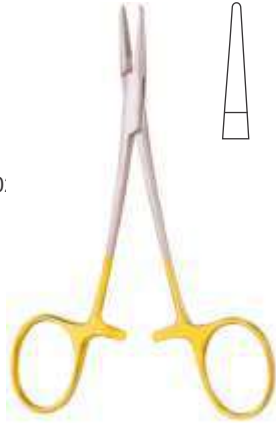

**HALSTED "TC"**  
NF.03.00.51  
11.5 cm/ 4½"



NF.03.00.12

NF.03.00.13

**DERF**  
12 cm/ 4¾"



**WEBSTER**  
NF.03.01.12  
12.5 cm/ 5"



**WEBSTER "TC"**  
NF.03.02.62  
12.5 cm/ 5"



**HALSEY**  
NF.03.03.13  
13.5 cm/ 5¼"



**HALSEY "TC"**



NF.03.04.62  
12 cm/ 4¾"

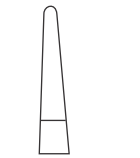

NF.03.04.63  
13.5 cm/ 5¼"



**COLLIER**  
NF.03.05.13  
13 cm/ 5⅛"

# Needle Holders



**BAUMGARTNER**  
NF.03.05.14  
14 cm / 5½"

**BAUMGARTNER "TC"**  
NF.03.05.64  
14 cm / 5½"

**BROWN**  
NF.03.06.13 13 cm / 5¼"  
NF.03.08.18 18 cm / 7¼"

**CONVERSE**  
NF.03.06.15  
15 cm / 6"

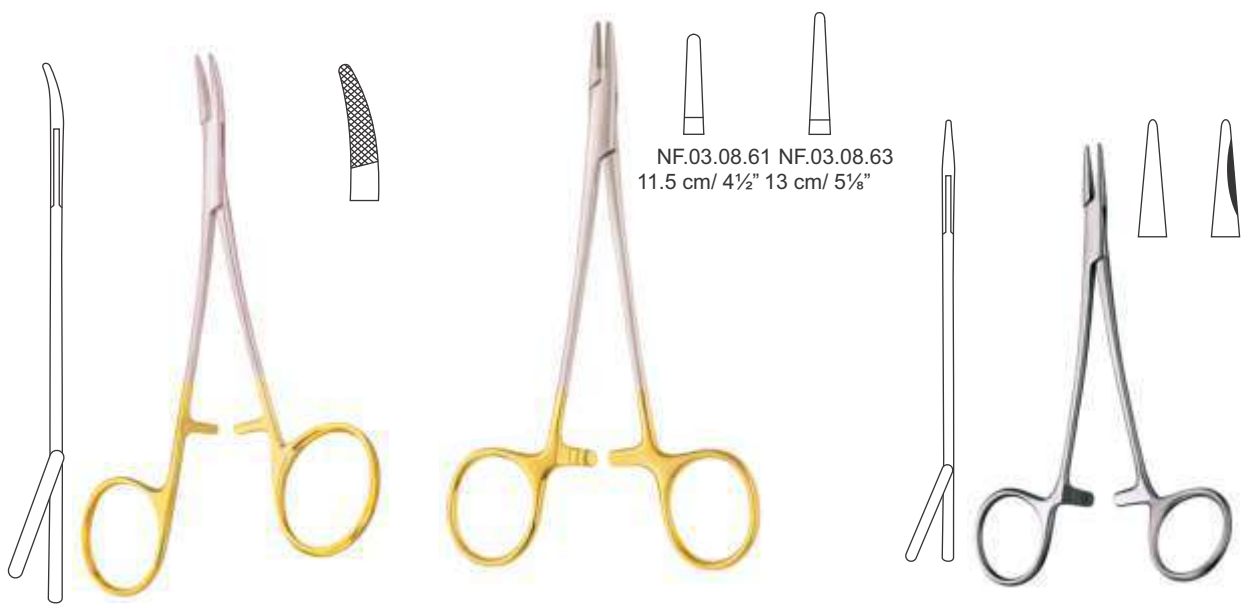

**CONVERSE "TC"**  
NF.03.07.65  
15 cm / 6"

**NAGATA**

NF.03.08.61 NF.03.08.63  
11.5 cm / 4½" 13 cm / 5¼"

**NEIVERT**  
NF.03.09.12  
12.5 cm / 5"

# Needle Holders

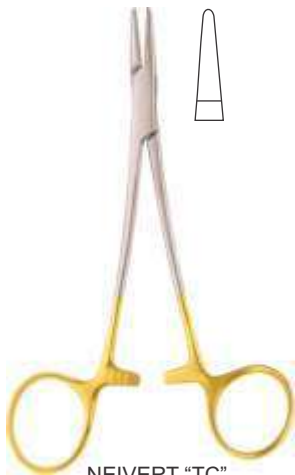

NEIVERT "TC"  
NF.04.10.62  
12.5 cm / 5"



DOYEN  
NF.04.11.13  
13 cm / 5 1/8"



WRIGHT (DERF)  
NF.04.12.12  
12.5 cm / 5"



"TC"  
NF.04.13.61  
12.5 cm / 5"

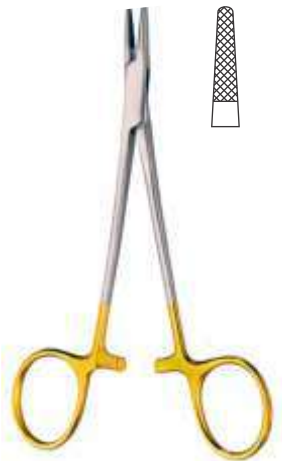

WRIGHT (DERF) "TC"  
NF.04.13.62  
12.5 cm / 5"



HALSEY  
NF.04.14.13  
13.5 cm / 5 1/4"

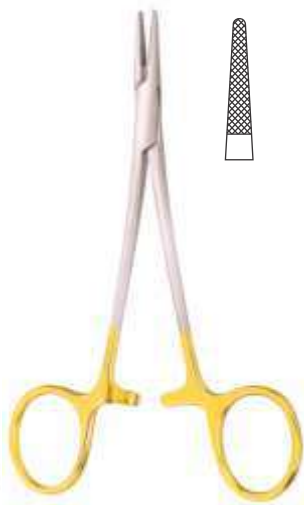

HALSEY "TC"  
NF.04.15.63  
13.5 cm / 5 1/4"



REHBEIN BABY  
NF.04.16.11  
11.5 cm / 4 1/2"



DERF CONVERSE  
NF.04.17.82  
12.5 cm / 5"

# Needle Holders



**NEW ORLEANS**  
NF.04.18.18  
18 cm / 7½"



**NEW ORLEANS "TC"**  
NF.04.19.68  
18 cm / 7½"



**CRILE WOOD**

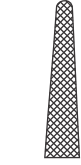

NF.04.21.18  
18 cm / 7½"



NF.04.21.20 20 cm / 8"  
NF.04.21.23 23 cm / 9"



NF.04.22.15  
15 cm / 6"



NF.04.22.18  
18 cm / 7½"



NF.04.22.20  
20 cm / 8"



NF.04.22.23  
23 cm / 9"



NF.04.27.25  
25 cm / 10"



NF.04.27.30  
30 cm / 11¼"

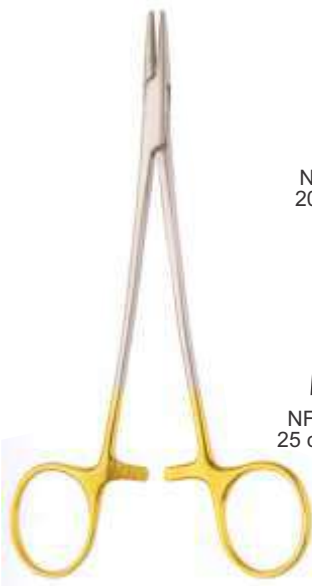

**CRILE WOOD "TC"**  
(DEBAKEY "TC")

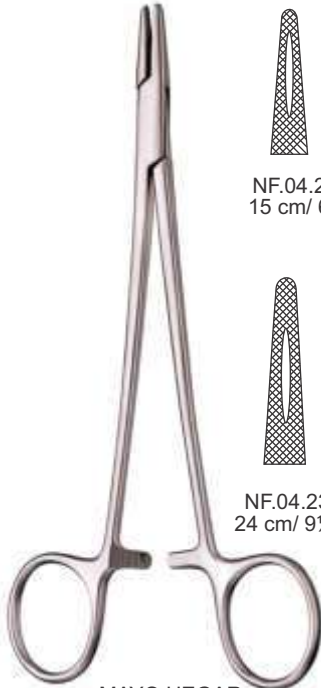

**MAYO HEGAR**

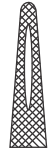

NF.04.23.15  
15 cm / 6"

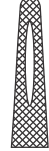

NF.04.23.18  
18 cm / 7½"

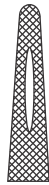

NF.04.23.20  
20 cm / 8"



NF.04.23.23  
23 cm / 9"

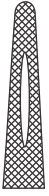

NF.04.23.24  
24 cm / 9½"

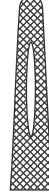

NF.04.23.26  
26 cm / 10¼"







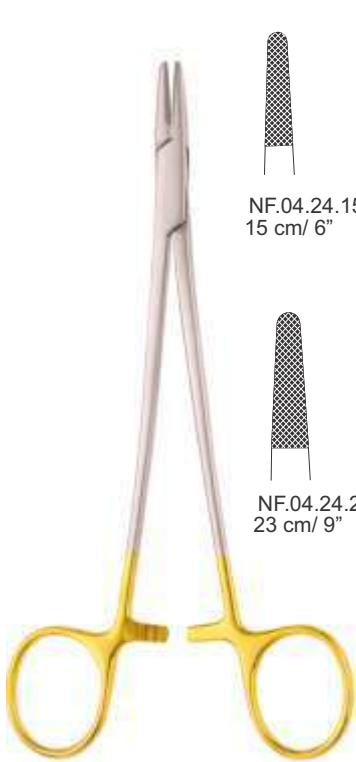

NF.04.23.30  
30 cm / 11¼"

# Needle Holders



MAYO HEGAR "TC"

-   
 NF.04.24.15  
 15 cm / 6"
-   
 NF.04.24.18  
 18 cm / 7½"
-   
 NF.04.24.20  
 20 cm / 8"



-   
 NF.04.24.23  
 23 cm / 9"
-   
 NF.04.24.24  
 24 cm / 9½"
-   
 NF.04.24.26  
 26 cm / 10¼"
-   
 NF.04.24.30  
 30 cm / 11¾"



HEGAR "TC"  
NF.04.25.71  
20.5 cm / 8"

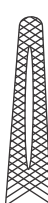
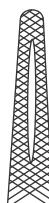

HEGAR

-   
 NF.04.25.17  
 17 cm / 6¾"
-   
 NF.04.25.20  
 20 cm / 8"
-   
 NF.04.26.37  
 17 cm / 6¾"
-   
 NF.04.26.40  
 20 cm / 8"

# Needle Holders

	 				
	<p>NF.04.27.65 15 cm/ 6"</p>	<p>NF.04.27.68 18 cm/ 7 1/8"</p>	<p>NF.04.28.20 20 cm/ 8"</p>	<p>NF.04.29.20 20 cm/ 8"</p>	
					
	<p>NF.04.27.70 20 cm/ 8"</p>	<p>NF.04.27.73 23 cm/ 9"</p>	<p>NF.04.28.23 23 cm/ 9"</p>	<p>NF.04.29.23 23 cm/ 9"</p>	
<p>MICRO SLIM "TC"</p>		<p>JULIAN</p>		<p>JULIAN "TC"</p>	
					
	<p>NF.04.30.18 18 cm/ 7 1/8"</p>	<p>NF.04.31.18 18 cm/ 7 1/8"</p>	<p>NF.04.31.23 23.5 cm/ 9 1/4"</p>	<p>NF.04.31.65</p>	<p>NF.04.31.64</p>
					
	<p>NF.04.30.27 27 cm/ 10 3/4"</p>	<p>NF.04.31.22 22 cm/ 8 3/4"</p>	<p>NF.04.31.27 27 cm/ 10 3/4"</p>		
<p>SAROT</p>		<p>SAROT "TC"</p>		<p>INTRACARDIAC "TC" 14 cm/ 5 1/2"</p>	



# Needle Holders



**BABY CRILE WOOD**  
NF.04.32.15  
15 cm / 6"



**CRILE MURRAY**  
NF.04.32.45  
15 cm / 6"



**BABY CRILE WOOD "TC"**  
NF.04.33.15  
15 cm / 6"



Grooved Jaws

**CRILE WOOD**  
NF.04.34.15  
15 cm / 6"



**CRILE WOOD "TC"**  
NF.04.35.15  
15 cm / 6"



**ADSON**  
NF.04.36.17  
18 cm / 7 1/8"



**METZENBAUM HEGAR**  
NF.04.37.18  
18 cm / 7 1/8"



**HEANEY**  
NF.04.38.21  
21 cm / 8 1/4"

# Needle Holders



HEANEY "TC"  
NF.04.39.21  
21 cm / 8¼"

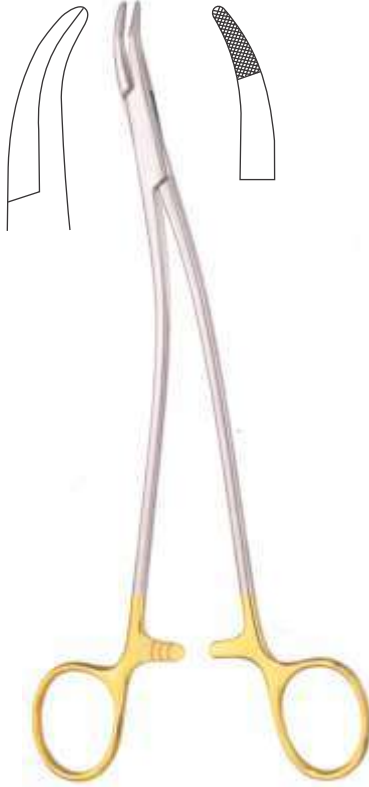

STRATTE "TC"  
NF.04.41.20 20 cm / 8"  
NF.04.41.24 24 cm / 9½"



RYDER (FRENCH EYE) "TC"

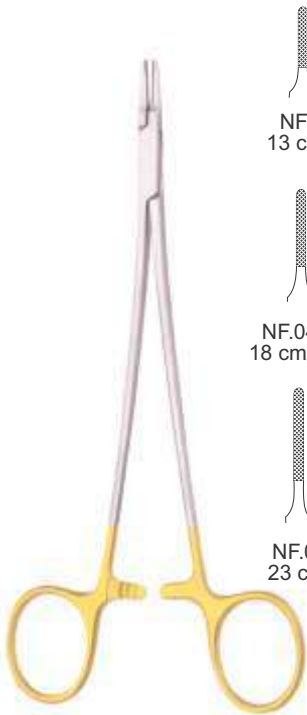
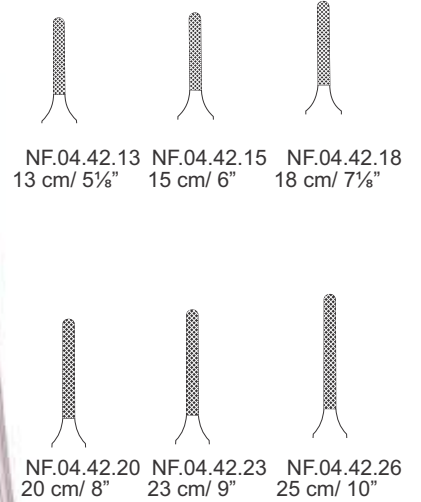

MINI RYDER "TC"  
VASCULAR

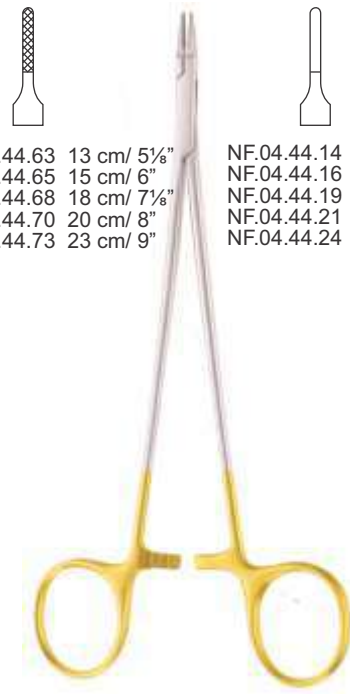
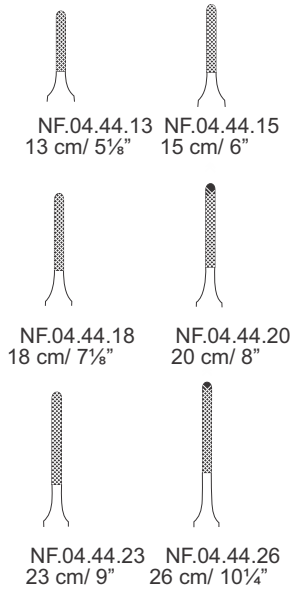



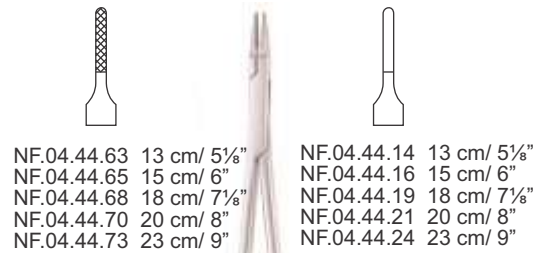



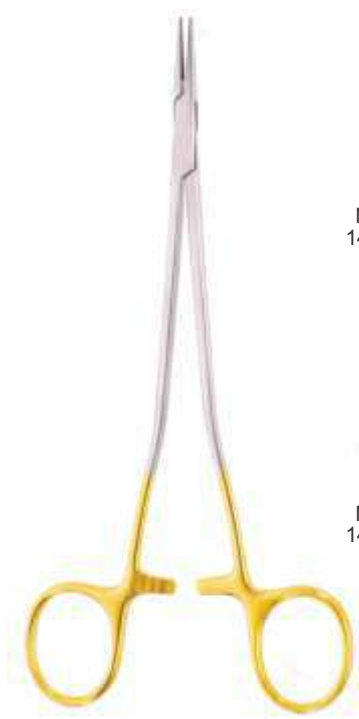

RYDER SLIM "TC"



# Needle Holders



MICROVASCULAR "TC"

			
NF.04.30.65 14 cm/ 5½"	NF.04.30.69 18 cm/ 7¼"	NF.04.30.71 20 cm/ 8"	NF.04.30.74 23 cm/ 9"
			
NF.04.30.64 14 cm/ 5½"	NF.04.30.68 18 cm/ 7¼"	NF.04.30.70 20 cm/ 8"	NF.04.30.73 23 cm/ 9"

extremely delicate

	
NF.04.45.15 15 cm/ 6" NF.04.45.17 17 cm/ 6¾"	NF.04.45.16 15 cm/ 6" NF.04.45.18 17 cm/ 6¾"



SENNING "TC"



SENNING  
NF.04.46.17  
17 cm/ 6¾"

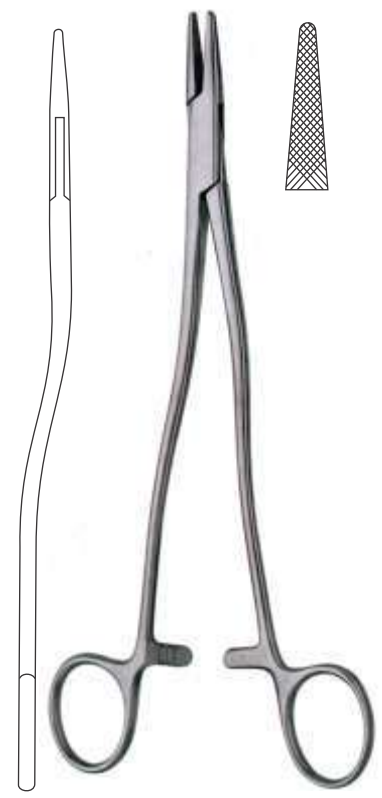

THOMSON WALKER  
(BOZEMANN)  
NF.04.47.20  
20 cm/ 8"

# Needle Holders

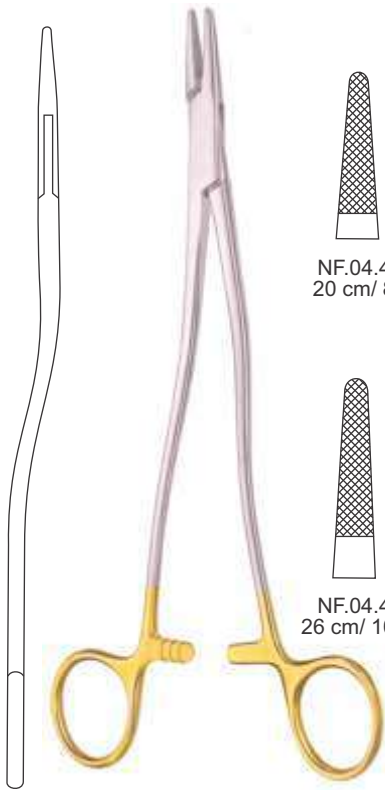

**BOZEMANN  
(WERTHEIM) "TC"**

NF.04.48.20  
20 cm/ 8"

NF.04.48.24  
24 cm/ 9½"

NF.04.48.26  
26 cm/ 10¼"

NF.04.48.30  
30 cm/ 11¾"



**MASSON  
NF.04.49.27  
27 cm/ 10¾"**



**MASSON "TC"  
NF.04.50.27  
27 cm/ 10¾"**



**WANGENSTEEN  
NF.04.51.28  
28 cm/ 11"**



**WANGENSTEEN "TC"  
NF.04.52.28  
28 cm/ 11"**

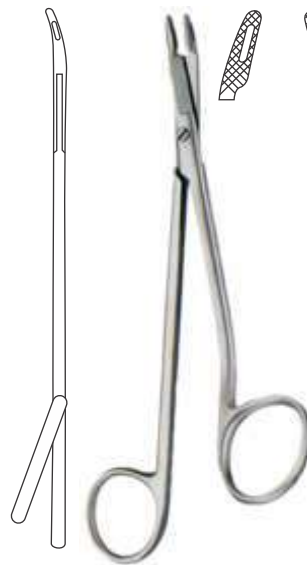

**GILLIES SLIM  
NF.04.53.14  
14.5 cm/ 5¾"**

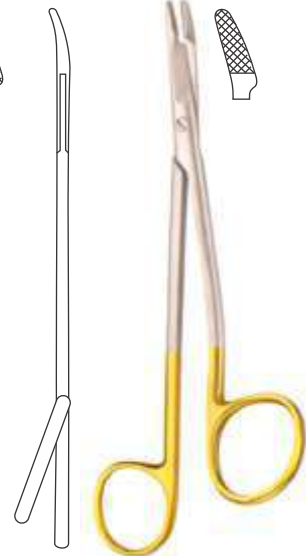

**GILLIES SLIM "TC"  
NF.04.54.15  
14.5 cm/ 5¾"**

# Needle Holders

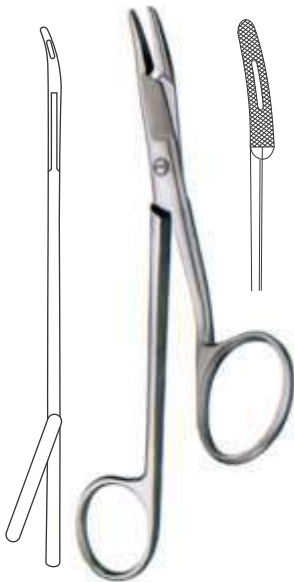

**GILLIES**  
NF.04.55.15  
15 cm/ 6"

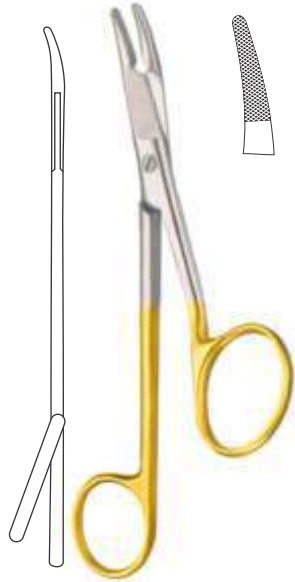

**GILLIES "TC"**  
NF.04.56.16  
15 cm/ 6"



**FINOCHIETTO**  
NF.04.57.27  
27 cm/ 10 3/4"



**FINOCHIETTO "TC"**  
NF.04.58.27  
27 cm/ 10 3/4"



**KILNER**  
NF.04.59.13  
13 cm/ 5 1/8"

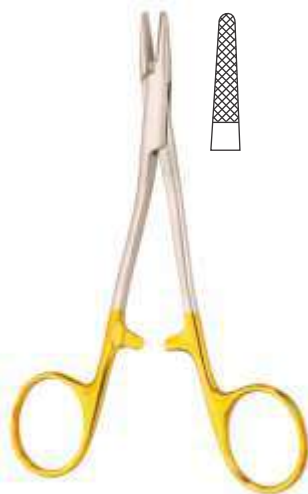

**KILNER "TC"**  
NF.04.60.13  
13 cm/ 5 1/8"



**OLSEN HEGAR MINI**  
12 cm/ 4 3/4"

NF.04.61.12

NF.04.61.13

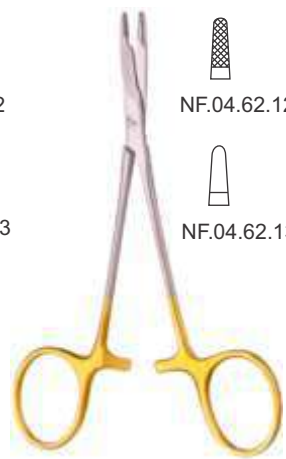

**OLSEN HEGAR MINI "TC"**  
12 cm/ 4 3/4"

NF.04.62.12

NF.04.62.13

# Needle Holders



OLSEN HEGAR

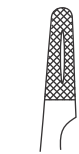

NF.04.63.14  
14 cm / 5½"



NF.04.63.17  
17 cm / 6¾"



NF.04.63.19  
19 cm / 7½"



OLSEN HEGAR "TC"



NF.04.64.14  
14 cm / 5½"



NF.04.64.17  
17 cm / 6¾"



NF.04.64.19  
19 cm / 7½"



MATHIEU KOCHER



NF.04.65.14  
14 cm / 5½"



NF.04.65.17  
17 cm / 6¾"



NF.04.65.20  
20 cm / 8"



MATHIEU KOCHER "TC"



NF.04.66.14  
14 cm / 5½"



NF.04.66.17  
17 cm / 6¾"



NF.04.66.20  
20 cm / 8"

# Needle Holders



MATHIEU

NF.04.67.14  
14 cm / 5½"



NF.04.67  
17 cm / 6¾"



NF.04.67  
20 cm / 8"



MATHIEU

NF.04.68.14 NF.04.68.17  
14 cm / 5½" 17 cm / 6¾"



NF.04.68.20 NF.04.68.24  
20 cm / 8" 24 cm / 9½"



MATHIEU "TC"

NF.04.69.14 NF.04.69.17  
14 cm / 5½" 17 cm / 6¾"



NF.04.69.20 NF.04.69.24  
20 cm / 8" 24 cm / 9½"



MATHIEU  
NF.04.70.13  
14 cm / 5½"



MATHIEU

NF.04.71.14  
14 cm / 5½"



NF.04.71.17  
17 cm / 6¾"

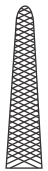

NF.04.71.20  
20 cm / 8"



NF.04.72.14  
14 cm / 5½"

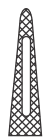

NF.04.72.17  
17 cm / 6¾"



NF.04.72.20  
20 cm / 8"

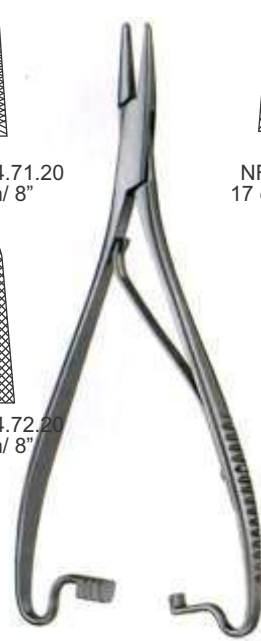

MATHIEU

NF.04.73.17  
17 cm / 6¾"



NF.04.73.20  
20 cm / 8"



NF.04.73.90  
20 cm / 8"



# Needle Holders



NF.04.74.14  
14 cm / 5½"

MATHIEU "TC"



NF.04.74.17  
17 cm / 6¾"



NF.04.74.20  
20 cm / 8"



ZWEIFEL



NF.04.76.20  
20 cm / 8"



NF.04.76.23  
23 cm / 9"



ZWEIFEL "TC"



NF.04.77.20  
20 cm / 8"



NF.04.77.23  
23 cm / 9"



"TC"



NF.04.79.20  
20 cm / 8"



NF.04.79.25  
25 cm / 10"



METZENBAUM  
MATHIEU "TC"



NF.04.81.17  
17 cm / 6¾"



NF.04.81.20  
20 cm / 8"



MATHIEU RYDER  
MICRO "TC"

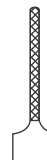

NF.04.80.67  
17 cm / 6¾"



NF.04.80.70  
20 cm / 8"

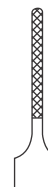

NF.04.80.74  
24 cm / 9½"



# Needle Holders



NF.04.82.70  
20 cm / 8"



NF.04.82.75  
25 cm / 10"

LICHTENBERG "TC"



NF.04.83.16  
16 cm / 6 1/4"



NF.04.83.18  
18 cm / 7 1/8"



NF.04.83.20  
20 cm / 8"

LANGENBECK



NF.04.84.16  
16 cm / 6 1/4"



NF.04.84.18  
18 cm / 7 1/8"



NF.04.84.21  
20 cm / 8"

LANGENBECK "TC"



CRILE  
NF.04.85.15  
15 cm / 6"



TOENNIS  
NF.04.86.18  
18 cm / 7 1/8"

# Needle Holders



TOENNIS "TC"



NF.04.87.16  
16 cm / 6¼"



NF.04.87.18  
18 cm / 7⅙"



NF.04.88.20  
20 cm / 8"



BOYNTON  
NF.04.91.12  
12 cm / 4¾"



BOYNTON "TC"  
NF.04.92.12  
12 cm / 4¾"



JACOBSON



NF.04.101.18  
18.5 cm / 7¼"

NF.04.101.21  
21 cm / 8¼"

with catch



JACOBSON "TC"



NF.04.102.18  
18.5 cm / 7¼"

NF.04.102.21  
21 cm / 8¼"

with catch



JACOBSON "TC"



NF.04.102.19  
18.5 cm / 7¼"

NF.04.102.20  
21 cm / 8¼"

# Needle Holders



NF.04.102.22 NF.04.102.23

JACOBSON "TC"  
18 cm / 7 1/8"



NF.04.102.24 NF.04.102.25

JACOBSON "TC"  
18 cm / 7 1/8"



NF.04.103.12 12 cm / 4 3/4"	NF.04.104.12 12 cm / 4 3/4"
NF.04.103.14 14 cm / 5 1/2"	NF.04.104.15 14 cm / 5 1/2"
NF.04.103.17 17 cm / 6 3/4"	NF.04.104.18 17 cm / 6 3/4"

with catch

CASTROVIEJO



with catch

CASTROVIEJO  
NF.04.103.34 14 cm / 5 1/2"  
NF.04.103.37 17 cm / 6 3/4"



NF.04.105.14 14 cm / 5 1/2"
NF.04.105.16 17 cm / 6 3/4"











NF.04.105.15 14 cm / 5 1/2"
NF.04.105.17 17 cm / 6 3/4"

CASTROVIEJO "TC"

# Needle Holders

									
	NF.04.105.44	NF.04.105.45	NF.04.105.46		NF.04.106.22		NF.04.107.24		NF.04.114.14
	14 cm / 5½"		17 cm / 6¾"						
<b>CASTROVIEJO "TC"</b>				<b>CASTROVIEJO MICRO</b>		<b>CASTROVIEJO MICRO</b>		<b>CASTROVIEJO (KOSHIMA)</b>	
				14.5 cm / 5¾"		14.5 cm / 5¾"		14.5 cm / 5¾"	

							
	NF.04.116.14	NF.04.117		NF.04.108.13			
<b>CASTROVIEJO (KOSHIMA)</b>			<b>CASTROVIEJO "TC"</b>		<b>BARRAQUER</b>	<b>BARRAQUER</b>	<b>BARRAQUER</b>
14.5 cm / 5¾"			13 cm / 5¼"		14 cm / 5½"		14 cm / 5½"

# Bandage Instruments



# Bandage Instruments



LORENZ  
NF.04.01.24  
24 cm / 9½"

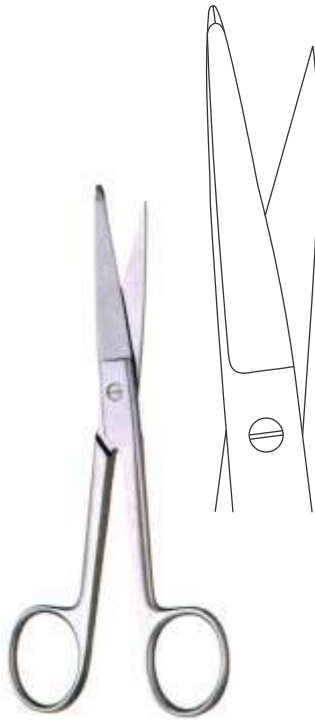

KNOWLES  
NF.04.02.14  
14 cm / 5½"

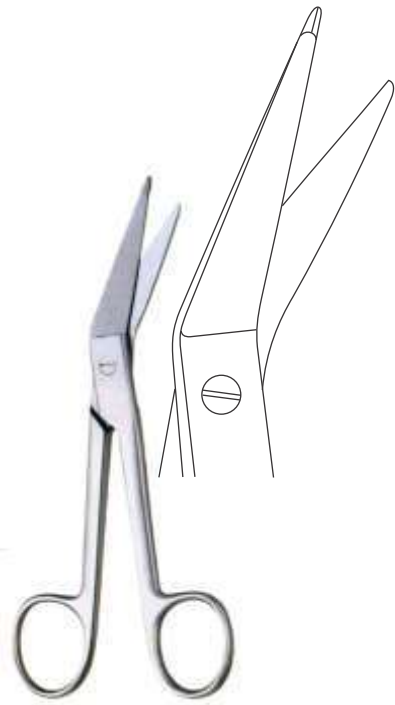

KNOWLES  
NF.04.03.84  
14 cm / 5½"



ESMARCH

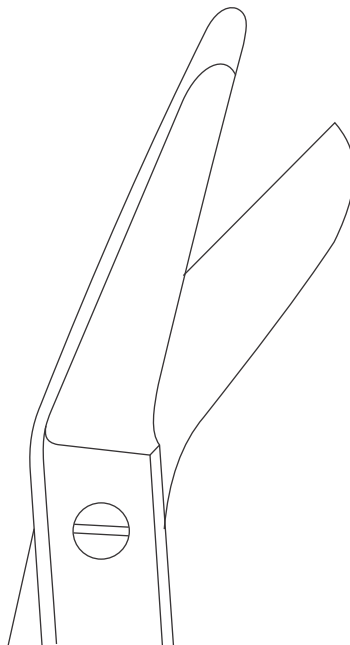

20 cm / 8"  
Standard  
NF.04.04.20

Supercut  
NF.04.04.120

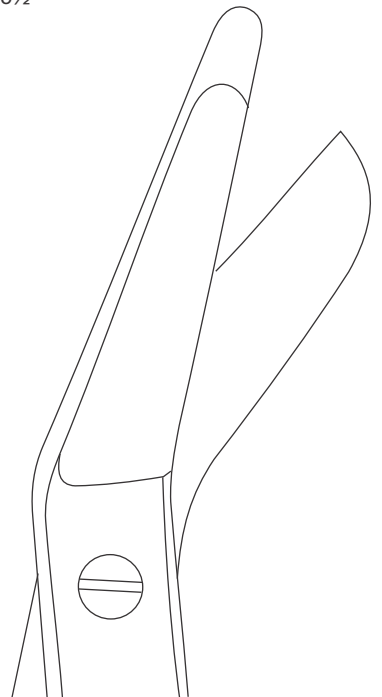

22 cm / 8¾"  
Standard  
NF.04.04.22

# Bandage Instruments

**UNIVERSAL**

14 cm/ 5½"  
Black NF.04.08.14

14 cm/ 5½"  
Black NF.04.08.15  
Blue NF.04.08.15 BL  
Red NF.04.08.15 RD  
Yellow NF.04.08.15 YL  
Orange NF.04.08.15 OR  
Pink NF.04.08.15 PK

18 cm/ 7¼"  
Black NF.04.08.18  
Blue NF.04.08.18 BL  
Red NF.04.08.18 RD  
Yellow NF.04.08.18 YL  
Orange NF.04.08.18 OR  
Pink NF.04.08.18 PK



**BERGMANN**  
NF.04.05.23  
23 cm/ 9"



**BRUNS**  
23 cm/ 9"  
standard NF.04.07.24  
TC NF.04.07.74  
supercut NF.04.07.124



**BRUNS**  
NF.04.06.23  
24 cm/ 9½"

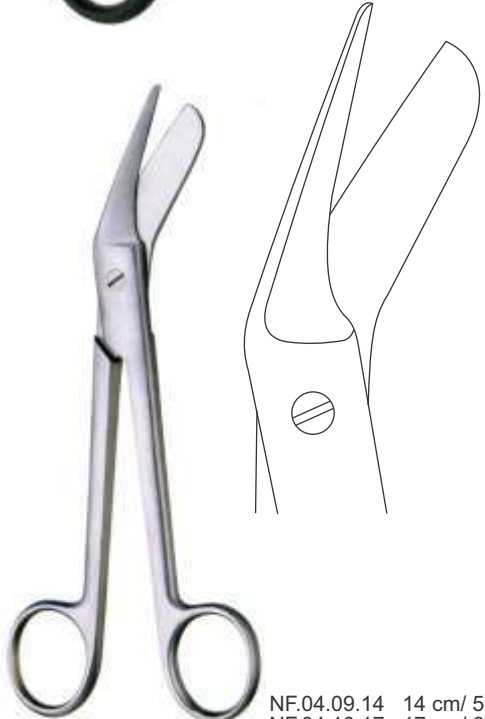

NF.04.09.14 14 cm/ 5½"  
NF.04.10.17 17 cm/ 6¾"

# Bandage Instruments



NF.04.11.15  
15 cm / 6"



LISTER

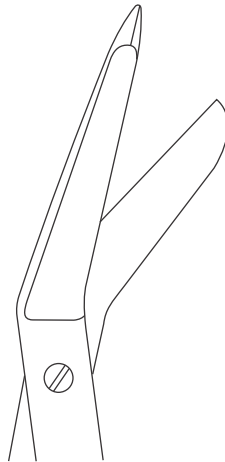

	standard	"TC"	supercut
9 cm / 3½"	NF.04.12.09	NF.04.12.59	
11.5 cm / 3½"	NF.04.12.11	NF.04.12.61	
14 cm / 5½"	NF.04.12.14	NF.04.12.64	NF.04.12.114
16 cm / 6¼"	NF.04.12.16	NF.04.12.66	NF.04.12.116
18 cm / 7¼"	NF.04.12.18	NF.04.12.68	NF.04.12.118
20 cm / 8"	NF.04.12.20	NF.04.12.70	NF.04.12.120

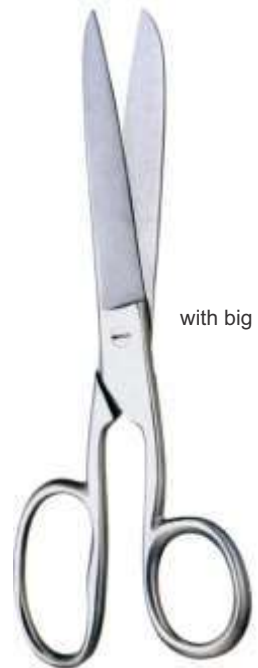

with big ring

SMITH  
NF.04.13.18  
18 cm / 7¼"



LISTER  
standard NF.04.14.96  
supercut NF.04.14.196  
16 cm / 6¼"



LISTER  
standard NF.04.17.20  
"TC" NF.04.17.80  
supercut NF.04.17.120  
20 cm / 8"



NF.04.15.21  
21 cm / 8¼"



SEUTIN  
NF.04.16.23  
23 cm / 9"



# Mallets



# Mallets



Ø 20mm



NF.04.01.17  
16.5 cm / 6½"  
100 g

solid head

NF.04.01.16  
16.5 cm / 6½"  
130 g

lead filled head

Ø 40 mm  
570 g



BERGMANN (HIBBS)  
NF.04.01.22  
22.5 cm / 9"

Ø 40 mm  
700 g



KIRK  
NF.04.02.20  
19.5 cm / 7¾"

Ø 25 mm  
120 g  
Ø 30 mm  
200 g  
Ø 35 mm  
260 g



DOYEN  
NF.04.03.01  
21 cm / 8"

NF.04.03.02  
21 cm / 8"

NF.04.03.03  
21 cm / 8"

Ø 40 mm  
770 g



OMBREDANNE  
NF.04.03.23  
23 cm / 9"

Ø 26 mm  
300 g

Ø 28 mm  
340 g

Ø 30 mm  
350 g



WILLIGER  
NF.04.04.01  
24 cm

NF.04.04.02  
24 cm

NF.04.04.03  
25 cm

# Mallets

Ø 30 mm  
200 g



COLLIN (LUCAS)  
NF.04.05.20  
21 cm / 8¼"

Ø 42/30mm  
530 g



NF.04.05.24  
24 cm / 9½"

Ø 30 mm  
400 g



GERZOG  
NF.04.07.18  
18 cm / 7⅛"

Ø 28 mm  
450 g

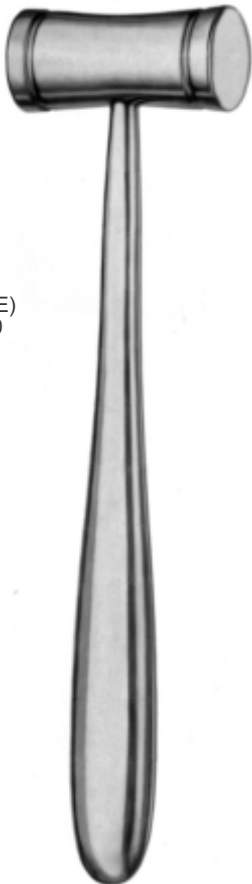

NF.04.05.23  
23 cm / 9"

Ø 26 mm  
300 g



MEAD  
NF.04.06.19  
18 cm / 7⅛"

Ø 25 mm  
200 g



NF.04.08.185  
spare facing

NF.04.08.18  
18.5 cm / 7¼"

NF.04.06.195  
spare facing

# Mallets



Ø 19 mm  
215 g

NF.04.09.19  
19 cm / 7½"



Ø 25 mm  
335 g

NF.04.10.25  
23 cm / 9"



Ø 37mm  
360 g

NF.04.10.134  
spare facing

NF.04.10.34  
24 cm / 9½"

# Mallets



NF.04.10.73  
Wrench only



WAGNER  
NF.04.10.70



130 g

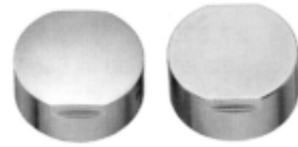

Ø 35 mm  
230 g  
NF.04.10.71  
Metal facing only

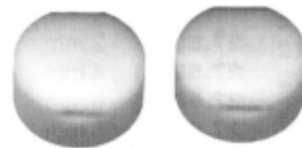

Ø 35 mm  
32 g  
NF.04.10.72  
Plastic facing only

# Mallets

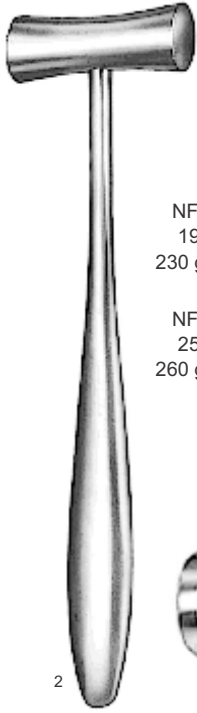

NF.04.11.01  
19 mm ø  
230 gm (8 oz)

NF.04.11.02  
25 mm ø  
260 gm (9 oz)

2  
LUCAE  
19 cm 7 1/2"



30 mm ø  
510 gm  
(18 oz)

1/3  
NF.04.12.22  
26 cm 10 1/2"



Ø 30mm  
215 g

NF.04.12.24  
24 cm/ 9 1/2"



NF.04.14.35 Ø 35 mm, 150 g  
NF.04.14.45 Ø 45 mm, 240 g  
NF.04.14.50 Ø 50 mm, 330 g  
26 cm/ 10 1/4"



Ø 26mm  
200 g

HAJEK  
NF.04.24.22  
21 cm/ 8 1/4"

# Intestinal and Tissue Grasping Forceps

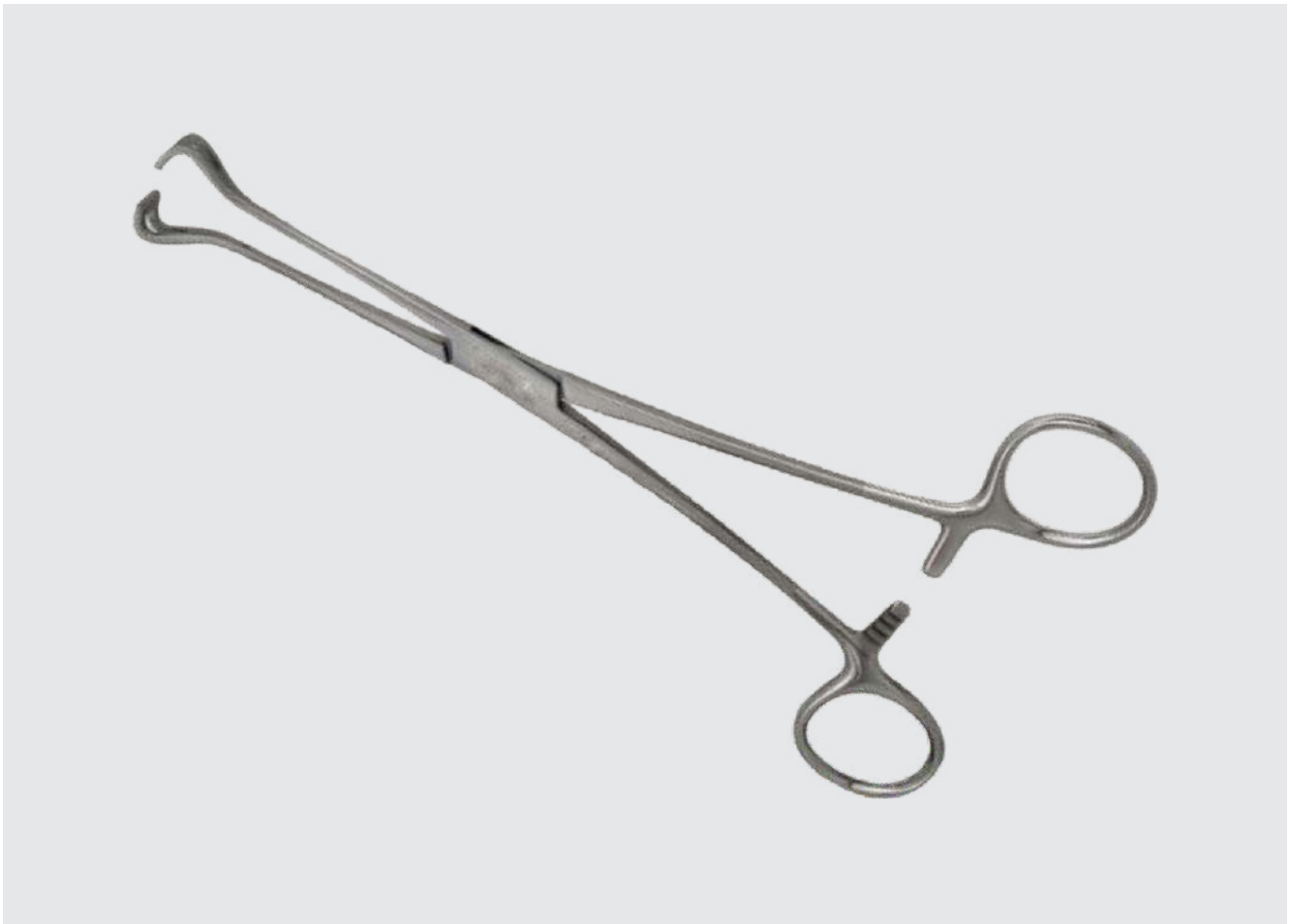

# Intestinal and Tissue Grasping Forceps



**ALLIS BABY**  
NF.04.01.13 13 cm/ 5½"  
NF.04.01.14 14 cm/ 5½"

**ALLIS**  
NF.04.02.15 15 cm/ 6"  
NF.04.02.29 19 cm/ 7½"

**ALLIS**  
NF.04.02.16 15 cm/ 6"  
NF.04.02.19 19 cm/ 7½"  
NF.04.02.20 20 cm/ 8"  
NF.04.02.23 23 cm/ 9"

**ALLIS-NIRO**  
NF.04.03.85  
15 cm/ 6"



**BOYS-ALLIS**  
NF.04.04.15  
15 cm/ 6"

**WILLIAMS**  
NF.04.05.16  
16 cm/ 6¼"

**ADAIR-ALLIS**  
NF.04.06.15  
15 cm/ 6"

**THOMS-ALLIS**  
NF.04.07.20  
20 cm/ 8"



# Intestinal and Tissue Grasping Forceps

4 x 5 teeth



**LOCKWOOD-ALLIS**  
NF.04.08.16  
16 cm / 6¼"

3 x 4 teeth

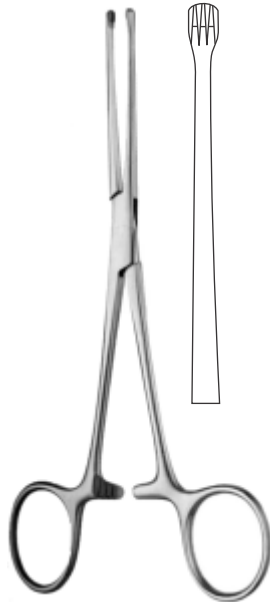

**JUDD-ALLIS**  
NF.04.09.65 15 cm / 6"  
NF.04.09.70 20 cm / 8"

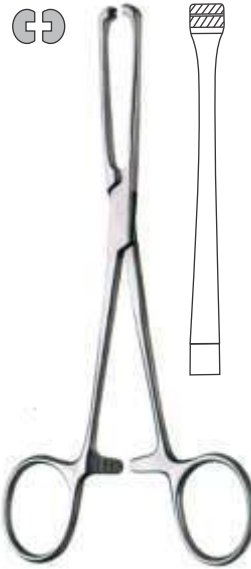

**ALLIS "AT"**  
NF.04.10.15 15.5 cm / 6⅞"  
NF.04.10.20 19 cm / 7½"

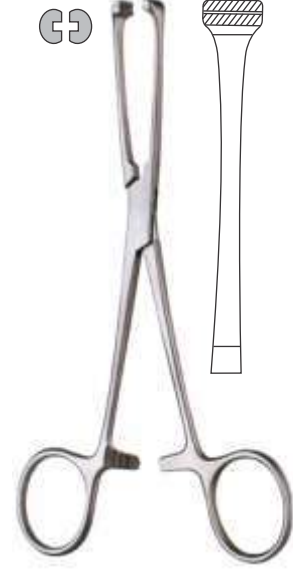

**ALLIS "AT"**  
NF.04.11.16 15.5 cm / 6⅞"  
NF.04.11.19 19 cm / 7½"  
NF.04.11.25 25.5 cm / 10"  
NF.04.11.30 30 cm / 12"



**BABCOCK-BABY**  
NF.04.12.16  
16 cm / 6¼"



**BABCOCK**

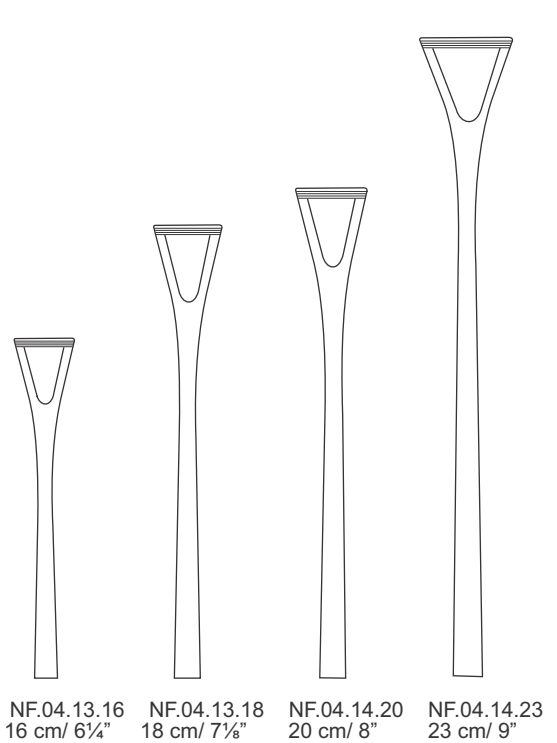

NF.04.13.16 16 cm / 6¼"  
NF.04.13.18 18 cm / 7⅞"  
NF.04.14.20 20 cm / 8"  
NF.04.14.23 23 cm / 9"

# Intestinal and Tissue Grasping Forceps



BABCOCK "AT"

BABCOCK "TC"

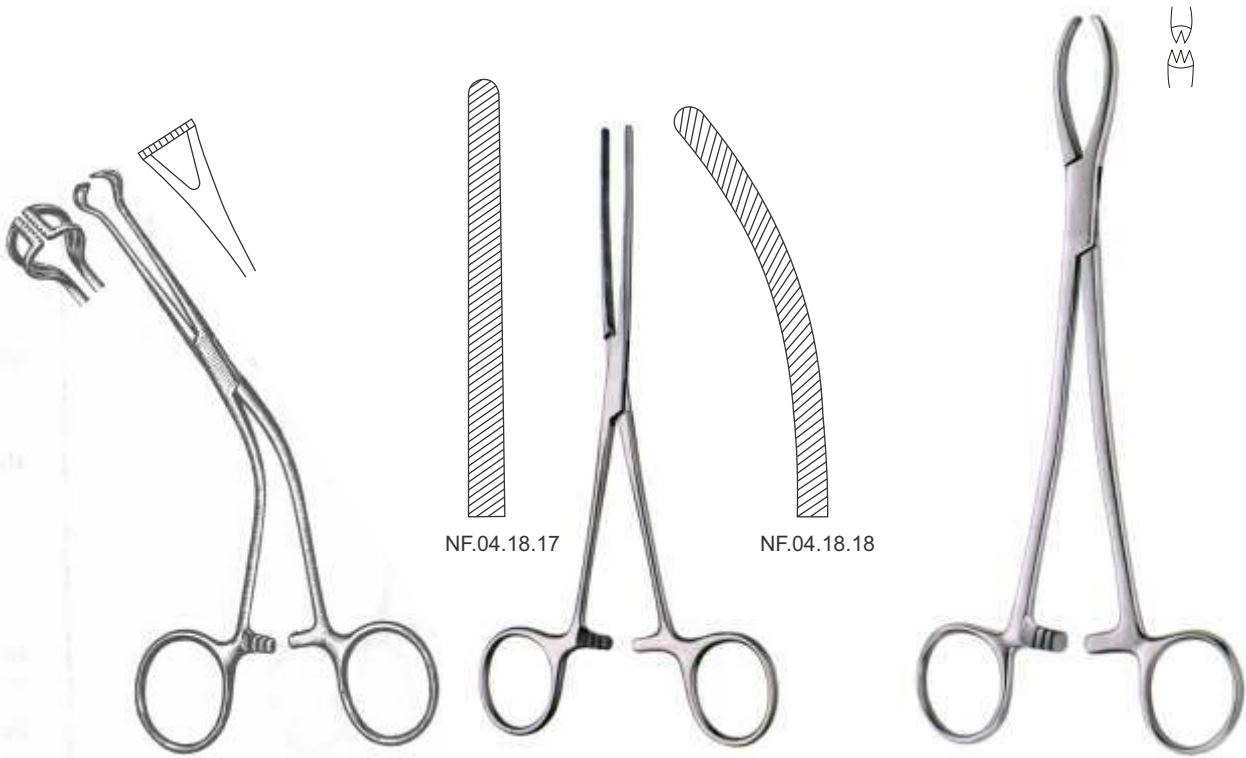

ALLIS-BABCOCK  
NF.04.17.86  
16 cm / 6 1/4"

DOYEN-BABY  
17 cm / 6 3/4"

LITTLEWOOD  
NF.04.19.18  
18.5 cm / 7 1/4"

# Intestinal and Tissue Grasping Forceps



DOYEN-BABY "AT"

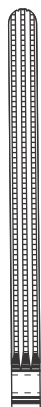

A



B



C



D

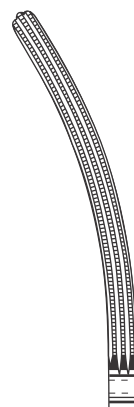

E

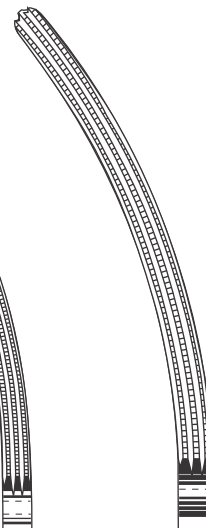

F

13 cm/ 5 $\frac{1}{8}$ "		16 cm/ 6 $\frac{1}{4}$ "		18 cm/ 7 $\frac{1}{8}$ "	
A	NF.04.19.63	B	NF.04.19.67	C	NF.04.19.69
D	NF.04.19.64	E	NF.04.19.68	F	NF.04.19.70

# Intestinal and Tissue Grasping Forceps



NF.04.20.23  
23 cm/ 9"

NF.04.20.26  
26 cm/ 10 1/4"

NF.04.20.28  
28 cm/ 11"

NF.04.21.23  
23 cm/ 9"

NF.04.21.26  
26 cm/ 10 1/4"

NF.04.21.28  
28 cm/ 11"

KOCHER

KOCHER

# Intestinal and Tissue Grasping Forceps



1/4

NF.04.22.23  
23 cm/ 9"

NF.04.22.26  
26 cm/ 10¼"

NF.04.22.28  
28 cm/ 11"

1/4

NF.04.23.23  
23 cm/ 9"

NF.04.23.26  
26 cm/ 10¼"

NF.04.23.28  
28 cm/ 11"

KOCHER "AT"

KOCHER "AT"

# Intestinal and Tissue Grasping Forceps

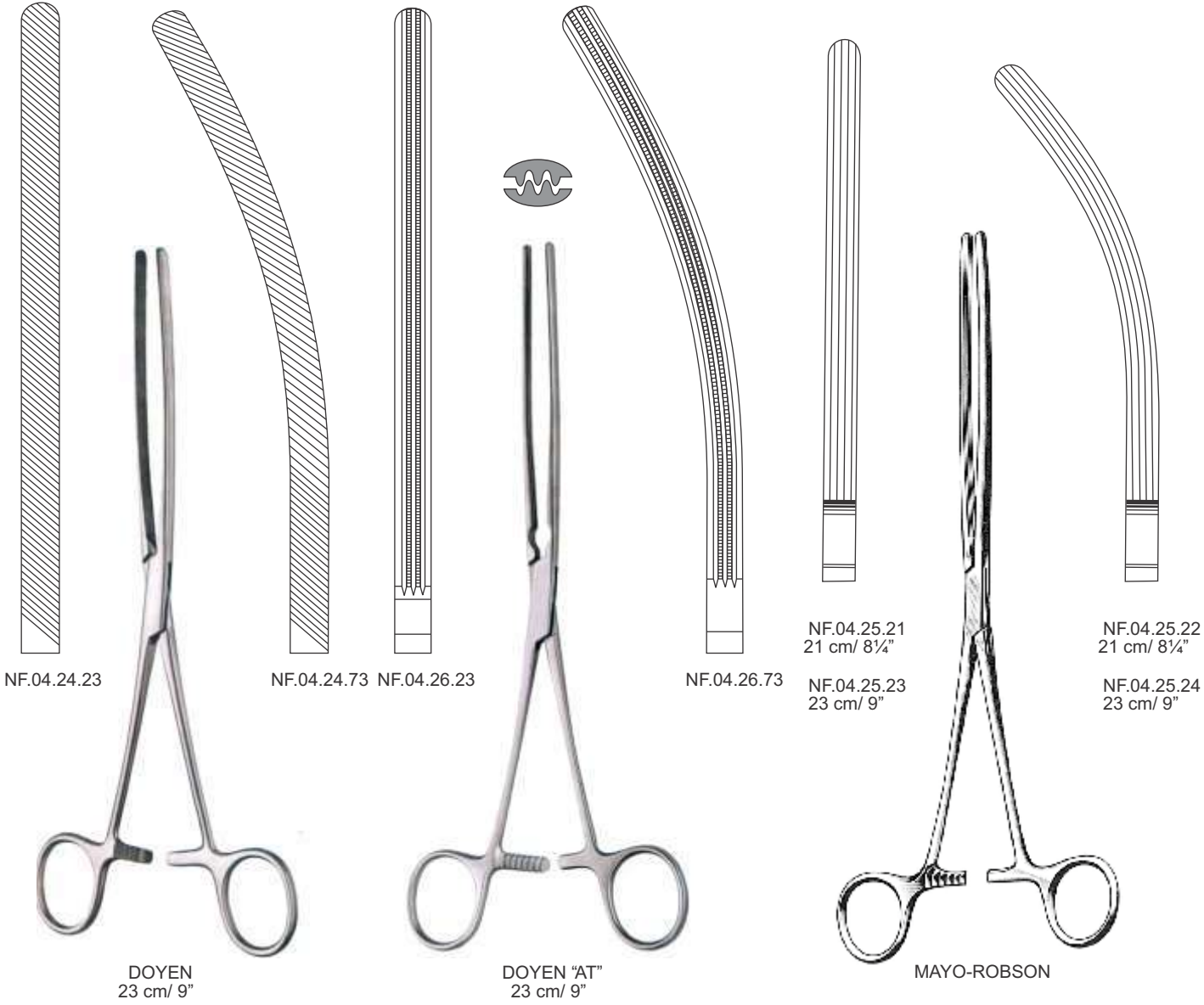

# Intestinal and Tissue Grasping Forceps

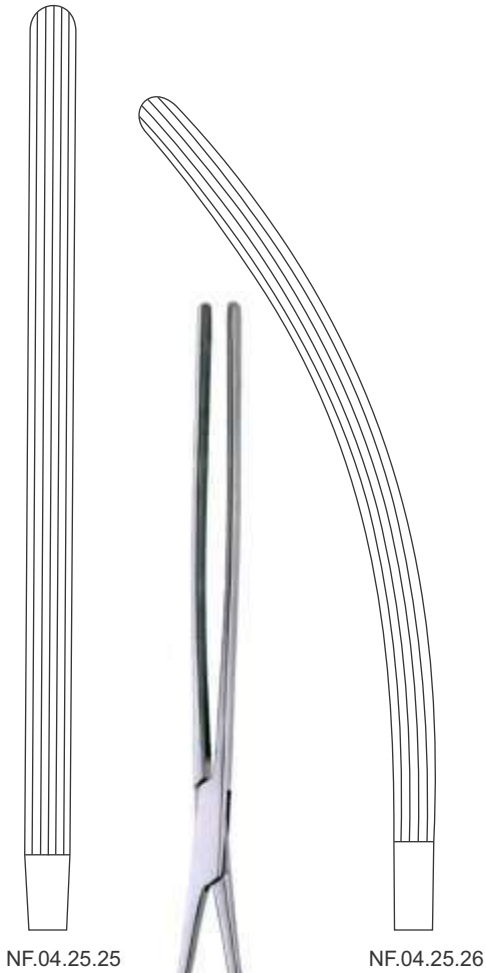

NF.04.25.25

NF.04.25.26

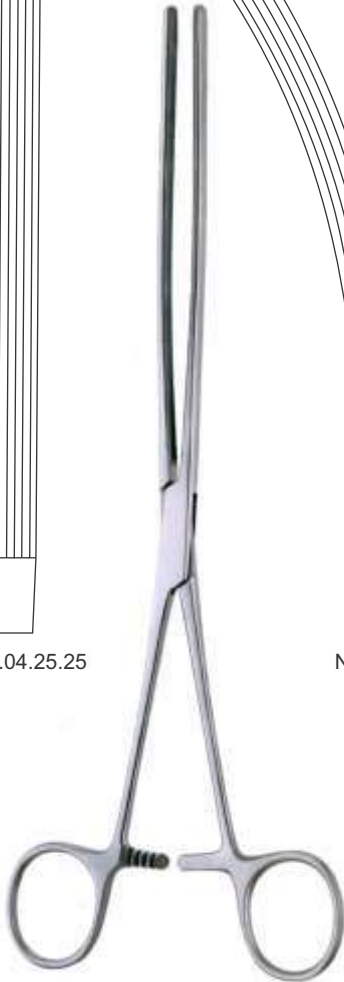

**MAYO ROBSON**  
25 cm / 10"

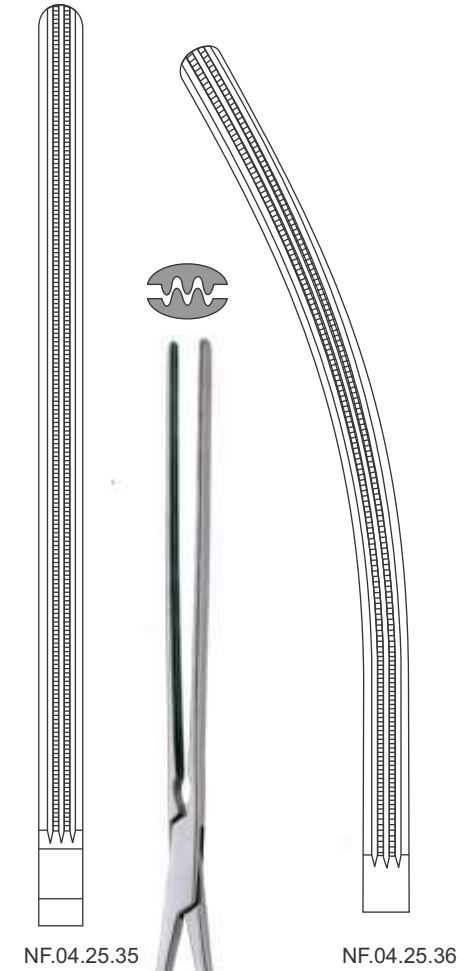

NF.04.25.35

NF.04.25.36

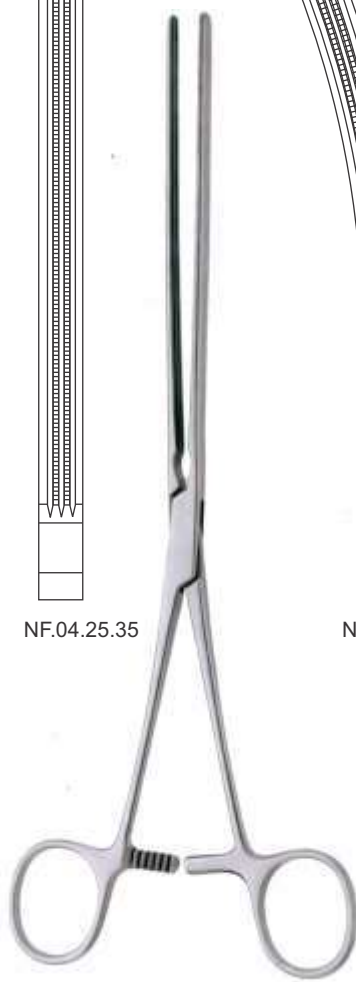

**MAYO ROBSON "AT"**  
25 cm / 10"

# Intestinal and Tissue Grasping Forceps

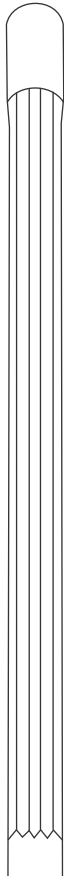

NF.04.27.25

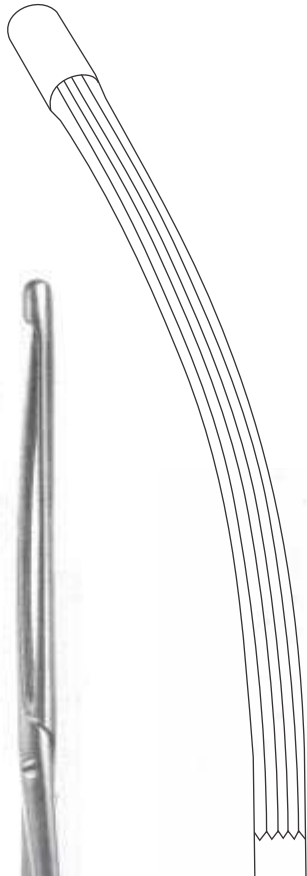

NF.04.27.26



NF.04.28.24  
24 cm / 9½"

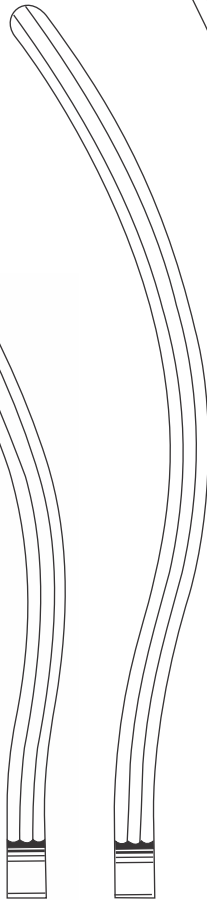

NF.04.28.26  
26 cm / 10¼"

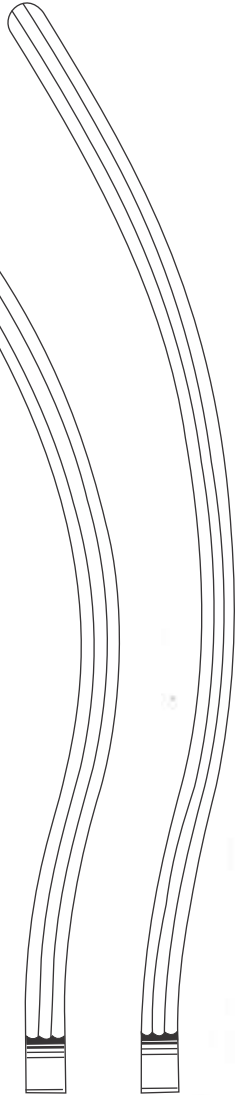

NF.04.28.28  
28 cm / 11"

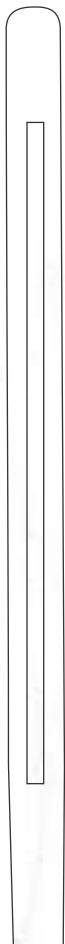

**NUSSBAUM**  
25 cm / 10"

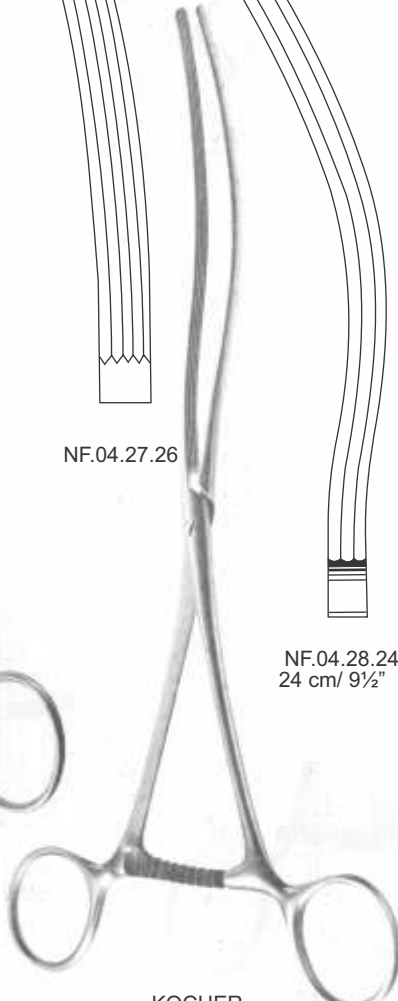

**KOCHER**

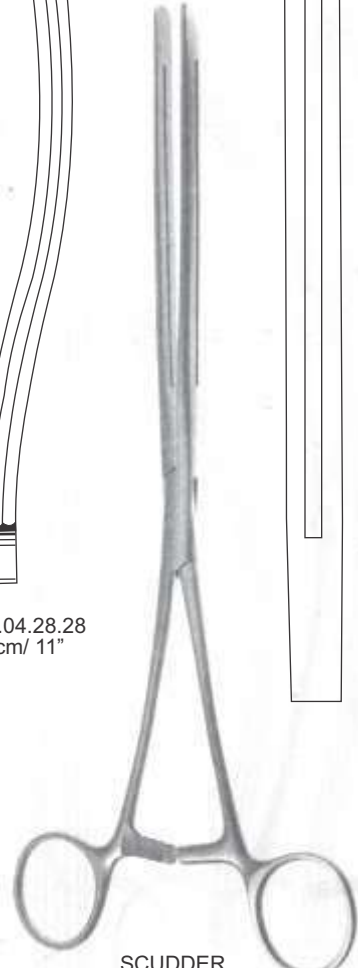

**SCUDDER**  
NF.04.29.25  
25 cm / 10"



# Intestinal and Tissue Grasping Forceps

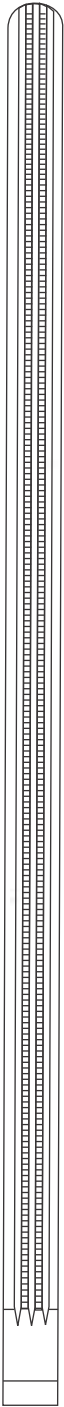

NF.04.29.33



SCUDDER "AT"  
33 cm / 13"

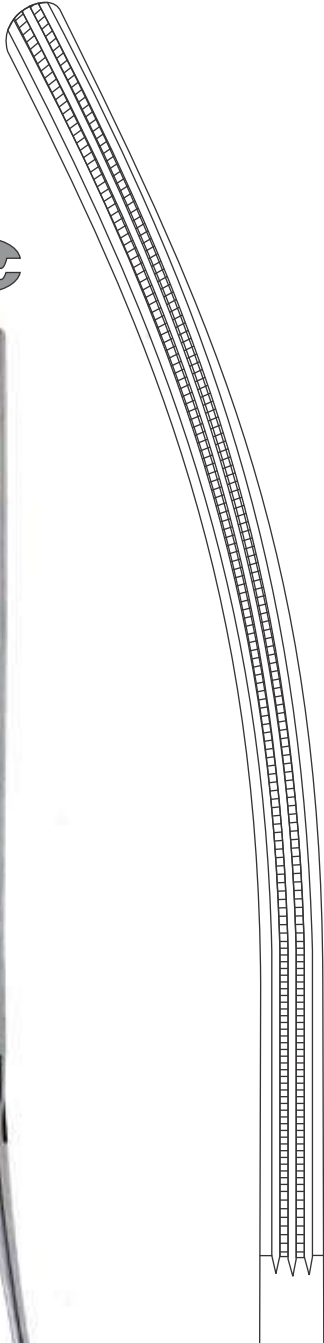

NF.04.29.34

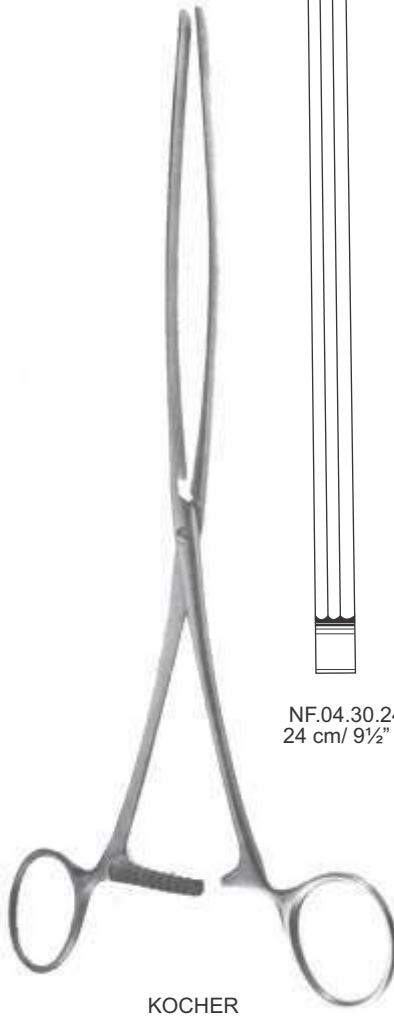

KOCHER



NF.04.30.24  
24 cm / 9½"



NF.04.30.26  
26 cm / 10¼"

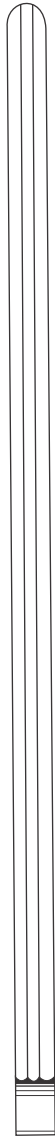

NF.04.30.28  
28 cm / 11"

# Intestinal and Tissue Grasping Forceps

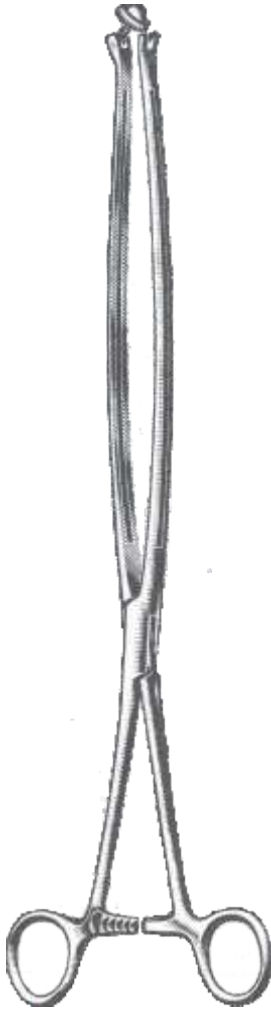

SCUDDER  
NF.04.31.36  
36 cm / 14"



SCUDDER  
NF.04.32.36  
36 cm / 14"

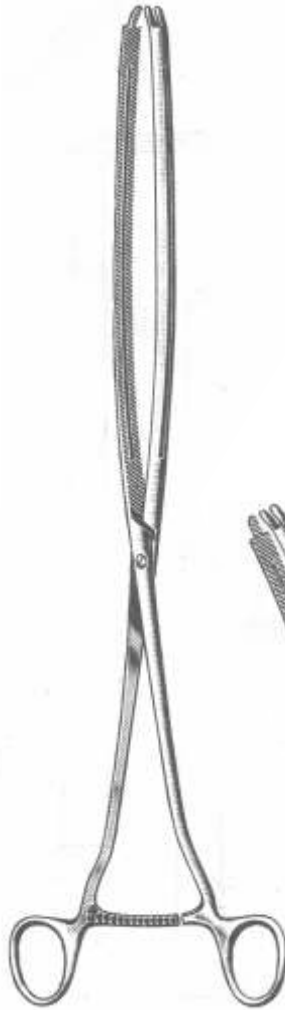

MOYNIHAN  
NF.04.33.36  
36 cm / 14"



MOYNIHAN  
NF.04.34.36  
36 cm / 14"

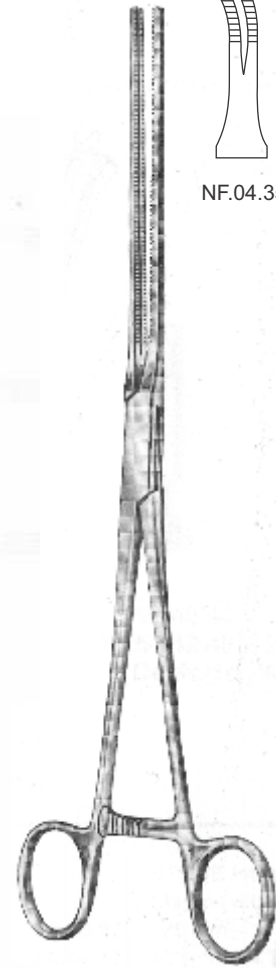

25 cm / 10"

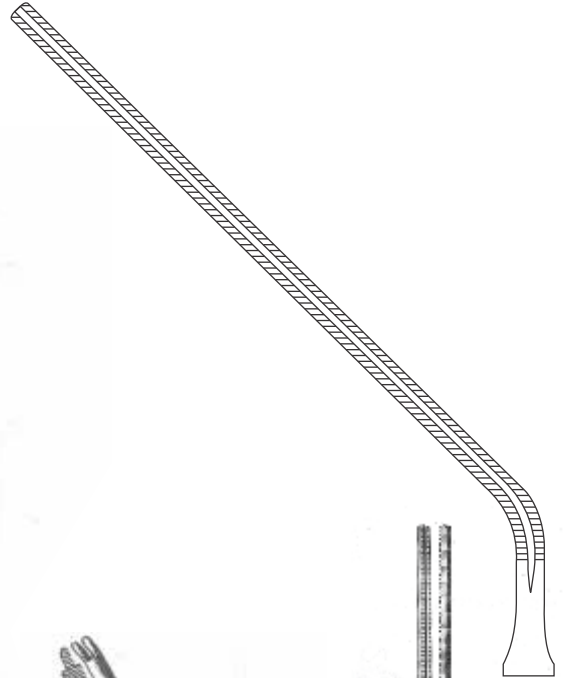

NF.04.35.26

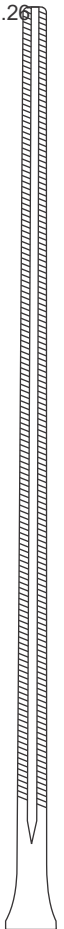

NF.04.35.25

# Intestinal and Tissue Grasping Forceps

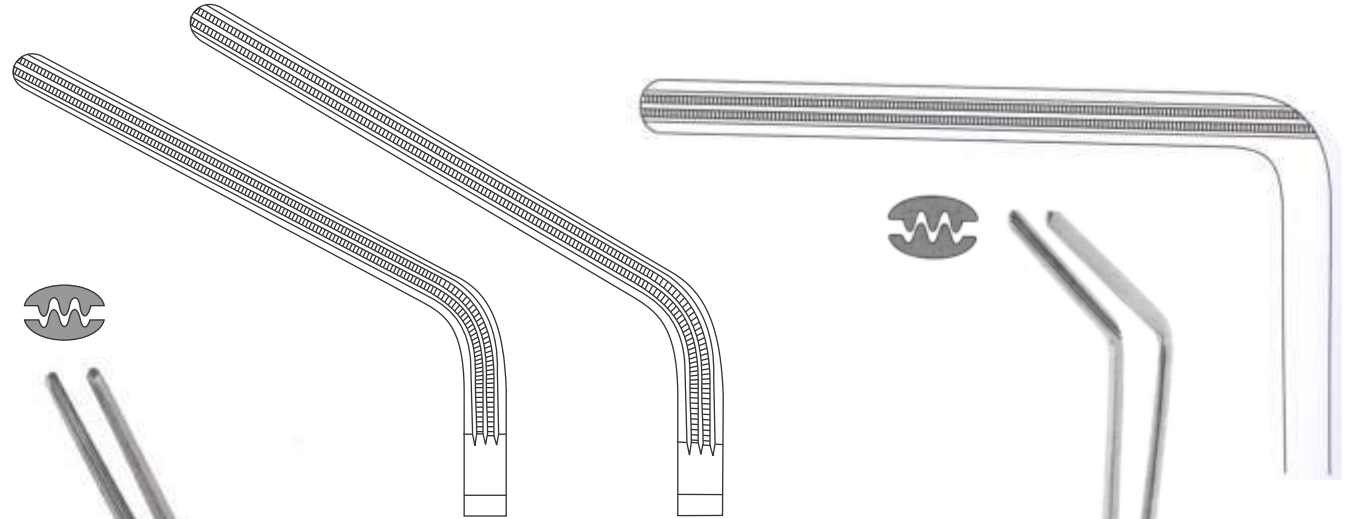

NF.04.35.40  
20 cm / 8"

NF.04.35.46  
26 cm / 10¼"



DEBAKEY "AT"



BRUNNER  
NF.04.36.24  
24 cm / 9½"



RESANO "AT"  
NF.04.36.28  
28 cm / 11"

# Intestinal and Tissue Grasping Forceps

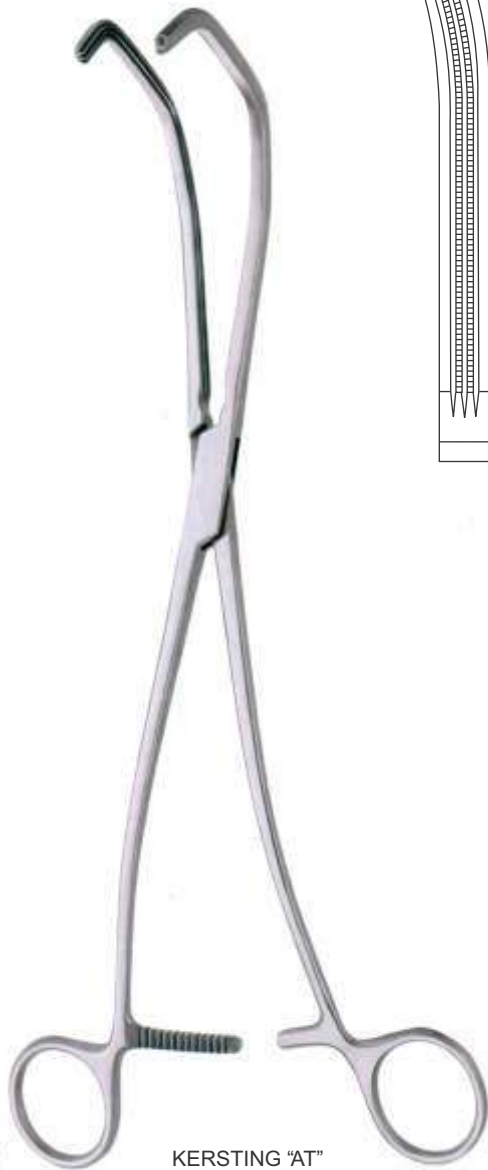

**KERSTING "AT"**  
NF.04.36.30  
30 cm / 11¼"

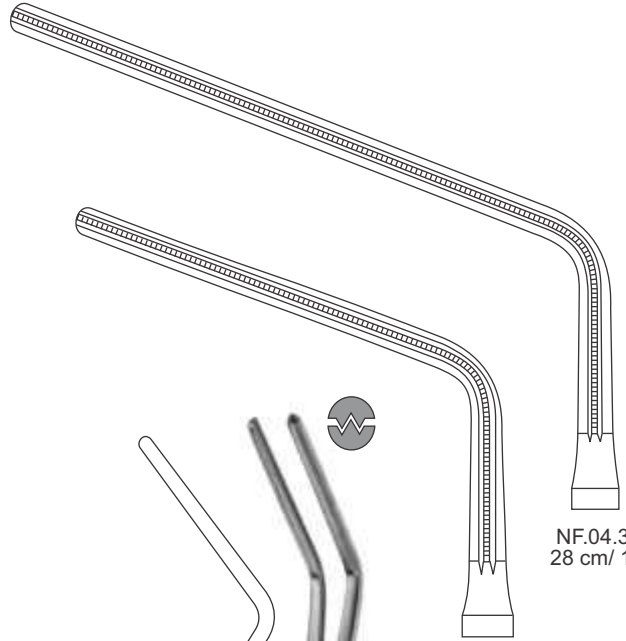

NF.04.36.37  
27 cm / 10¾"

NF.04.36.38  
28 cm / 11"

**HAYES "AT"**

# Intestinal and Tissue Grasping Forceps



# Intestinal and Tissue Grasping Forceps

With Pin

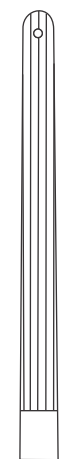

NF.04.42.14



**PAYR-BABY**  
14.5 cm / 5¾"



NF.04.43.14



**PAYR**



NF.04.44.20  
20 cm / 8"

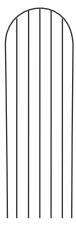

NF.04.44.28  
28 cm / 11"

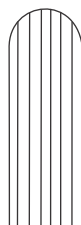

NF.04.44.35  
35 cm / 13¾"



NF.04.45.20  
20 cm / 8"

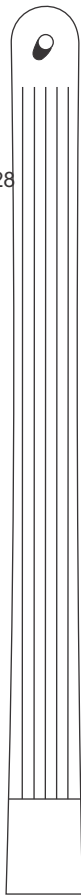

NF.04.45.28  
28 cm / 11"

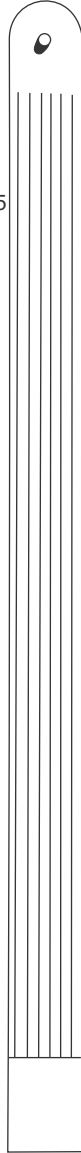

NF.04.45.35  
35 cm / 13¾"

# Intestinal and Tissue Grasping Forceps



CZERNY  
NF.04.48.22  
22 cm/ 8¾"



12/20 x 70 mm  
RICORD  
NF.04.49.16  
16 cm/ 6¼"

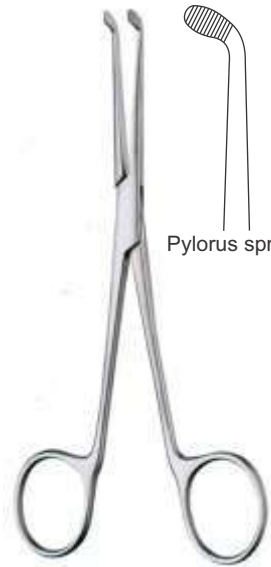

Pylorus spreader  
BENSON  
NF.04.50.15  
15 cm/ 6"



BODENHAMMER (SIMS)  
NF.04.52.16  
16 cm/ 6¼"



SIMS  
NF.04.53.16  
16 cm/ 6¼"

# Intestinal and Tissue Grasping Forceps



DEMARTEL-WOLFSON  
NF.04.54.05 50 mm  
NF.04.54.07 75 mm  
NF.04.54.10 100 mm

set of 3 pieces



DEMARTEL WOLFSON  
NF.04.55.09 8.5 cm  
NF.04.55.23 23 cm

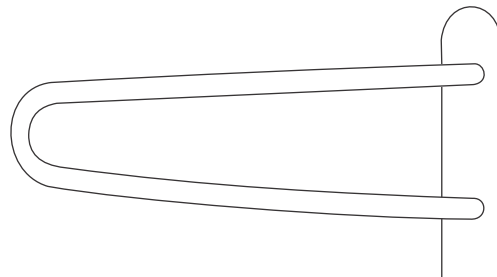

Blade Length  
NF.04.56.17 17 cm 20 x 60 mm  
NF.04.56.23 23 cm 23 x 80 mm  
NF.04.56.24 23 cm 23 x 125 mm  
NF.04.56.25 23 cm 23 x 150 mm



SIMS



# Intestinal and Tissue Grasping Forceps



**PRATT**  
NF.04.57.21  
21 cm / 8¼"



**MATHIEU**  
NF.04.58.21  
21 cm / 8¼"



**BRINKERHOFF**  
NF.04.59.13 Ø 13-25 x 90 mm  
NF.04.59.15 Ø 15-25 x 100 mm  
NF.04.59.19 Ø 19-32 x 115 mm



**IVES-FANSLER**  
NF.04.60.21  
Ø 21 x 85 mm



Sphincteroscopes

**KELLY**  
NF.04.61.25 Ø 25 x 50 mm  
NF.04.61.21 Ø 21 x 50 mm

# Intestinal and Tissue Grasping Forceps

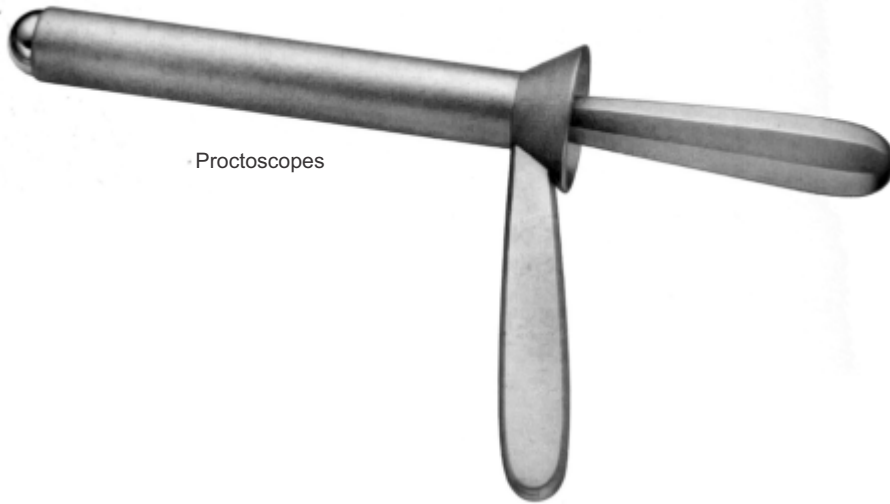

Proctoscopes

**KELLY**  
NF.04.62.23 Ø 23 x 145 mm  
NF.04.62.24 Ø 23 x 205 mm



**NEWMAN**  
NF.04.63.01 – ø 16 mm x 63 mm  
NF.04.63.02 – ø 19 mm x 63 mm  
NF.04.63.03 – ø 23 mm x 63 mm



**BENSAUDE**  
NF.04.63.19 Ø 19 x 70 mm  
NF.04.63.22 Ø 22 x 70 mm



Anusscopes

**HIRSCHMANN**  
NF.04.64.16 Ø 16 x 60 mm  
NF.04.64.19 Ø 19 x 70 mm  
NF.04.64.22 Ø 22 x 90 mm

# Intestinal and Tissue Grasping Forceps

Lateral blades only (Pair)



NF.04.64.74  
Frame only



NF.04.64.50

**ALAN PARKS**  
Comprising 1 Retractor  
bows with fine adjustment ratchets,  
1 adjustable centre blade and  
NF.04.64.50 with 2 Adult size lateral blades.  
NF.04.64.51 with 2 Child size lateral blades.  
NF.04.64.52 with 2 Sphincterotomy size lateral blades.  
NF.04.64.53 with 2 Anastomosis size lateral blades.

Adult size	
Child size	
Sphincterotomy size	
Anastomosis size	
Centre Blade	
Illuminated Centre Blade	

# Intestinal and Tissue Grasping Forceps



**NAUNTON MORGAN**  
NF.04.64.70  
Large, 64 mm long x 24 mm diameter

NF.04.64.71  
Medium, 64 mm long x 20.5 mm diameter

NF.04.64.72  
Small, 64 mm long x 17 mm diameter

NF.04.64.73  
Illumination stem for metal proctoscope.



malleable

**PRATT**  
NF.04.68.20  
28 cm/ 11"  
nickel silver



malleable

**BUIE**  
NF.04.69.16  
21.5 cm/ 8½"  
nickel silver



**BRODIE**  
NF.04.70.18  
18 cm/ 7⅞"



**LOCKHART MUMMERY**  
16 cm/ 6¼"



NF.04.70.21  
# 1



NF.04.70.22  
# 2

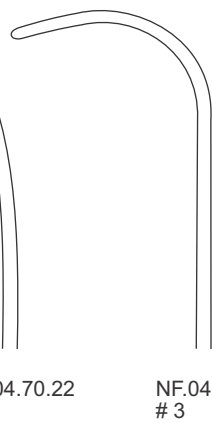

NF.04.70.23  
# 3

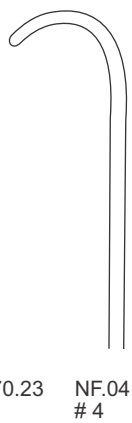

NF.04.70.24  
# 4

# Intestinal and Tissue Grasping Forceps

max. spread 115 mm

NF.04.70.52 X 72 mm  
Lateral blades only (Pair)



NF.04.70.54  
Frame only

PARK  
NF.04.70.50  
1X NF.04.70.54  
1X NF.04.70.55

23 X 70 mm  
Blades

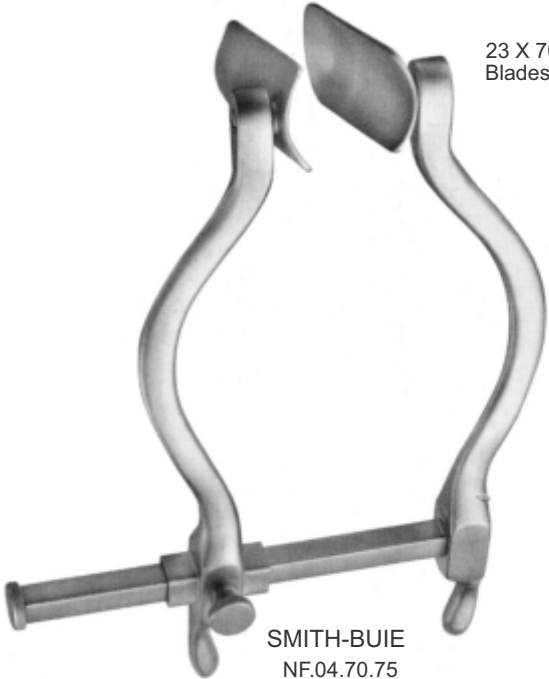

SMITH-BUIE  
NF.04.70.75

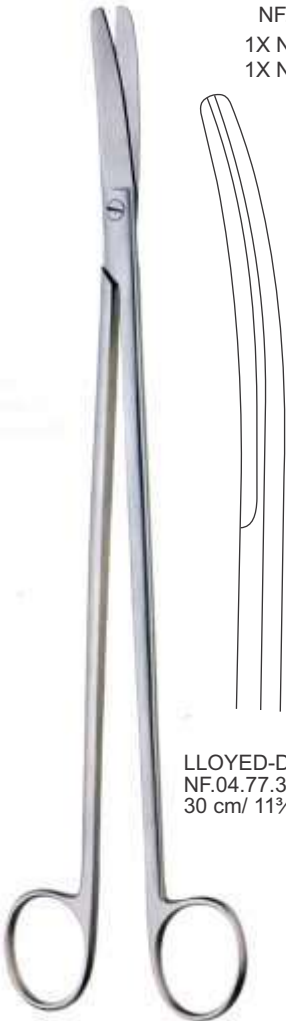

LLOYED-DAVIS  
NF.04.77.31  
30 cm / 11 3/4"

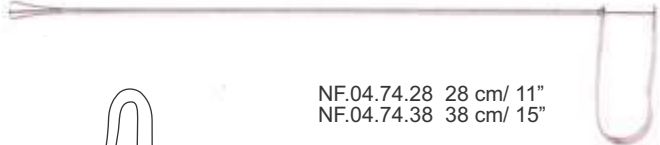

NF.04.74.28 28 cm / 11"  
NF.04.74.38 38 cm / 15"



PRATT  
21 cm / 8 1/4"



NF.04.78.21



NF.04.78.22



NF.04.78.23

# Intestinal and Tissue Grasping Forceps

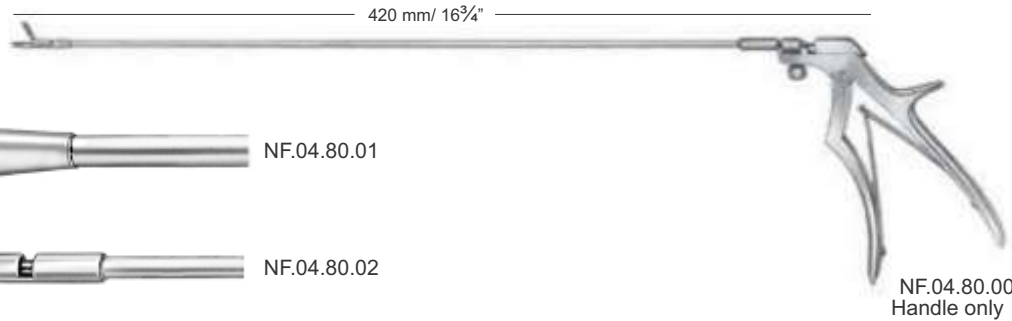

MCGIVNEY  
NF.04.81.19  
19 cm / 7 1/2"



HEYWOOD-SMITH  
NF.04.82.21  
21 cm / 8 1/4"

# Intestinal and Tissue Grasping Forceps

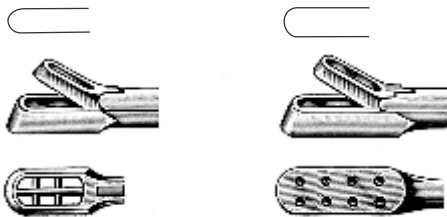
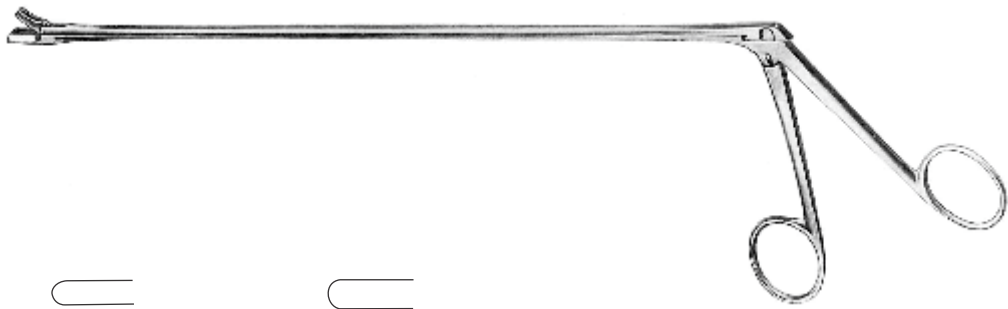
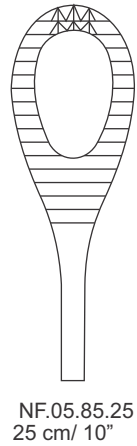

Shaft length		
28 cm / 11"	NF.05.86.18	NF.05.86.28
35 cm / 13¾"	NF.05.86.25	NF.05.86.35
43 cm / 17"	NF.05.86.33	NF.05.86.43

# Intestinal and Tissue Grasping Forceps





# Intestinal and Tissue Grasping Forceps



HOESEL  
NF.05.89.50  
25 cm/ 10"

# Intestinal and Tissue Grasping Forceps

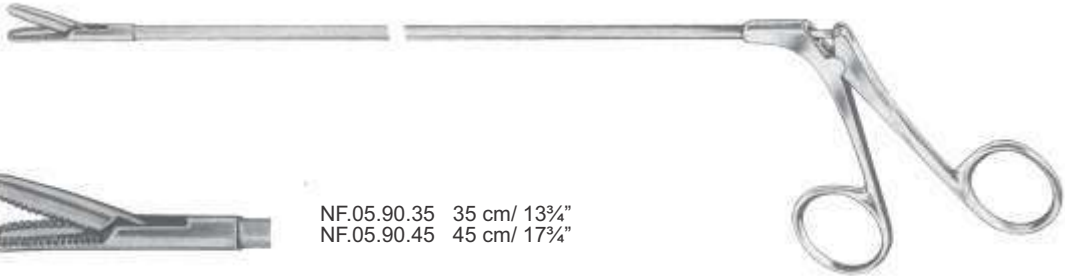

INSULATED BIOPSY FORCEPS  
for Rectal HF-Surgery

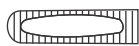

NF.05.90.35 35 cm / 13<sup>3</sup>/<sub>4</sub>"  
NF.05.90.45 45 cm / 17<sup>3</sup>/<sub>4</sub>"



NF.05.91.35 35 cm / 13<sup>3</sup>/<sub>4</sub>"  
NF.05.91.45 45 cm / 17<sup>3</sup>/<sub>4</sub>"



NF.05.92.35 35 cm / 13<sup>3</sup>/<sub>4</sub>"  
NF.05.92.45 45 cm / 17<sup>3</sup>/<sub>4</sub>"



NF.05.93.35 35 cm / 13<sup>3</sup>/<sub>4</sub>"  
NF.05.93.45 45 cm / 17<sup>3</sup>/<sub>4</sub>"



NF.05.94.35 35 cm / 13<sup>3</sup>/<sub>4</sub>"  
NF.05.94.45 45 cm / 17<sup>3</sup>/<sub>4</sub>"

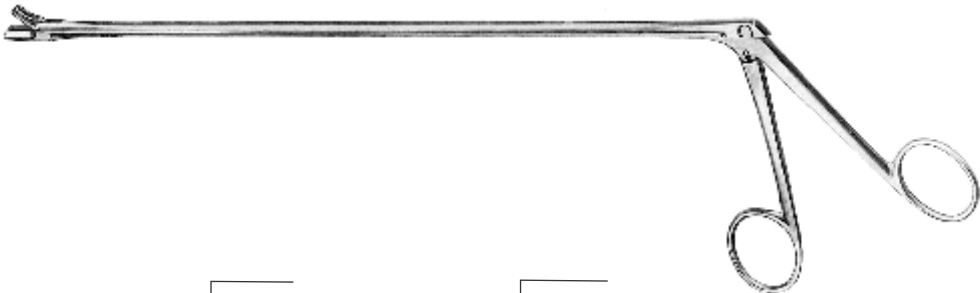

YEOMAN



Shaft length		
28 cm / 11"	NF.05.95.18	NF.05.95.28
35 cm / 13 <sup>3</sup> / <sub>4</sub> "	NF.05.95.25	NF.05.95.35
43 cm / 17"	NF.05.95.33	NF.05.95.43

# Intestinal and Tissue Grasping Forceps



NF.05.95.63 35 cm/ 13<sup>3</sup>/<sub>4</sub>"  
NF.05.95.64 45 cm/ 17<sup>3</sup>/<sub>4</sub>"



NF.05.95.51

NF.05.95.52

JACKSON  
35 cm/ 13<sup>3</sup>/<sub>4</sub>"



Combined Suction  
HAEMORRHOIDAL LIGATOR  
NF.05.98.48  
33 cm/ 13"

# Gynecology



105 x 38 mm



105 x 27 mm



88 x 25 mm



AUVARD  
NF.05.02.24  
24 cm/ 9½"

SIMON  
28 cm/ 11"

NF.05.03.28  
115 x 22 mm

NF.05.03.29  
115 x 27 mm

MARTIN  
NF.05.03.25  
25 cm/ 10"

LONDON  
NF.05.03.22  
22 cm/ 8¾"

# Gynecology



**DOYEN**  
25 cm/ 10"

- NF.05.04.01 55 x 45 mm
- NF.05.04.02 85 x 45 mm
- NF.05.04.03 115 x 45 mm

60 x 30 mm



**DOYEN**  
NF.05.06.23  
23 cm/ 9"



**MATZENAUER**  
20-23 cm/ 8"-9"

- NF.05.06.50 90 x 20 mm
- NF.05.06.51 100 x 10 mm
- NF.05.06.52 100 x 15 mm
- NF.05.06.53 100 x 20 mm
- NF.05.06.54 100 x 25 mm
- NF.05.06.55 110 x 25 mm
- NF.05.06.56 110 x 30 mm
- NF.05.06.57 120 x 10 mm
- NF.05.06.58 120 x 15 mm
- NF.05.06.59 120 x 20 mm
- NF.05.06.60 120 x 25 mm
- NF.05.06.61 120 x 30 mm
- NF.05.06.62 120 x 35 mm
- NF.05.06.63 130 x 20 mm
- NF.05.06.64 130 x 25 mm
- NF.05.06.65 130 x 30 mm
- NF.05.06.66 130 x 35 mm
- NF.05.06.67 130 x 40 mm

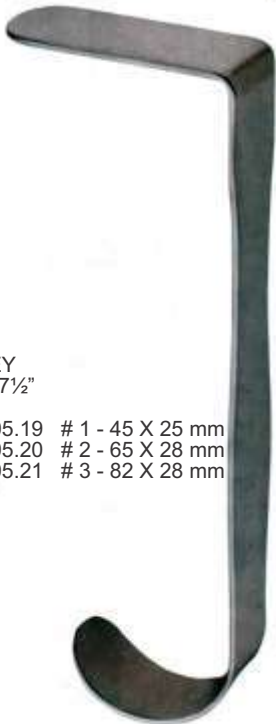

**HEANEY**  
19 cm/ 7½"

- NF.05.05.19 # 1 - 45 X 25 mm
- NF.05.05.20 # 2 - 65 X 28 mm
- NF.05.05.21 # 3 - 82 X 28 mm

80 x 30 mm



**DOYEN**  
NF.05.06.25  
25 cm/ 10"

# Gynecology

\* for virgins

Vienna pattern

Vienna pattern

(Ret. & Spec.)

Complete Set  
NF.05.09.01  
NF.05.09.05

**KRISTELLER**  
23 cm/ 9"

- \* NF.05.07.18 # 0 - 110 x 20 mm
- NF.05.07.24 # 1 - 110 x 27 mm
- NF.05.07.45 # 2 - 110 x 30 mm
- NF.05.07.56 # 3 - 110 x 36 mm

**KRISTELLER**  
23 cm/ 9"

- \*NF.05.07.19 # 0 - 115 x 17 mm
- NF.05.07.25 # 1 - 115 x 23 mm
- NF.05.07.46 # 2 - 115 x 26 mm
- NF.05.07.57 # 3 - 115 x 32 mm

**MATHIEU**  
20 cm/ 8"

- \*NF.05.09.10 # 1 - 95 x 16 - 26 mm
- NF.05.09.15 # 2 - 95 x 16 - 30 mm

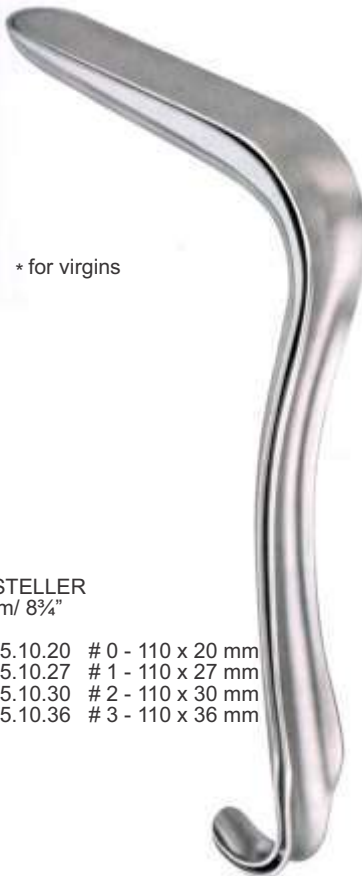

\* for virgins

**MATHIEU**  
20 cm/ 8"

- \* NF.05.09.25 # 1 - 100 x 11 - 20 mm
- NF.05.09.35 # 2 - 100 x 14 - 26 mm

**KRISTELLER**  
22 cm/ 8<sup>3</sup>/<sub>4</sub>"

- \* NF.05.10.20 # 0 - 110 x 20 mm
- NF.05.10.27 # 1 - 110 x 27 mm
- NF.05.10.30 # 2 - 110 x 30 mm
- NF.05.10.36 # 3 - 110 x 36 mm

**KRISTELLER**  
22 cm/ 8<sup>3</sup>/<sub>4</sub>"

- \*NF.05.12.17 # 0 - 115 x 17 mm
- NF.05.12.23 # 1 - 115 x 23 mm
- NF.05.12.26 # 2 - 115 x 26 mm
- NF.05.12.32 # 3 - 115 x 32 mm

# Gynecology



**KRISTELLER**  
22 cm/ 8¾"

- NF.05.11.20 # 0 - 110 x 20 mm
- NF.05.11.27 # 1 - 110 x 27 mm
- NF.05.11.30 # 2 - 110 x 30 mm
- NF.05.11.36 # 3 - 110 x 36 mm



**EASTMAN**  
17 cm/ 6¾"

- NF.05.13.10 75 x 38 mm
- NF.05.13.20 90 x 38 mm
- NF.05.13.33 100 x 38 mm



**JACKSON**  
17 cm/ 6¾"

- NF.05.14.10 75 x 38 mm
- NF.05.14.20 90 x 38 mm
- NF.05.14.30 100 x 38 mm

\* for virgins



**KRISTELLER**  
18 cm/ 7⅞"

- \* NF.05.15.15 # 0 - 70 x 15 mm
- NF.05.15.27 # 1 - 70 x 27 mm
- NF.05.15.30 # 2 - 75 x 30 mm
- NF.05.15.36 # 3 - 90 x 36 mm

**KRISTELLER**  
18 cm/ 7⅞"

- \* NF.05.16.10 # 0 - 75 x 10 mm
- NF.05.16.23 # 1 - 75 x 23 mm
- NF.05.16.25 # 2 - 80 x 25 mm
- NF.05.16.32 # 3 - 100 x 32 mm



# Gynecology

\* for virgins

**KRISTELLER**  
\* NF.05.17.0# 0 - 70 X 15 mm  
NF.05.17.1# 1 - 70 X 27 mm  
NF.05.17.2# 2 - 75 X 30 mm  
NF.05.17.3# 3 - 90 X 6 mm  
18 cm / 7 1/8"



set complete

for children

**KRISTELLER**  
NF.05.18.18  
21.5 cm / 8 1/2"  
110 x 18 mm



**KRISTELLER**  
NF.05.18.20  
21.5 cm / 8 1/2"  
110 x 18 mm



**KRISTELLER**  
NF.05.18.25  
21.5 cm / 8 1/2"  
115 x 14 mm



**BREISKY**  
NF.05.19.10  
# 1 - 70 x 22 mm  
76 x 25 mm  
12.5 cm / 5"

**NF.05.19.20**  
# 2 - 76 x 25 mm  
82 x 30 mm  
14.5 cm / 5 3/4"

**NF.05.19.30**  
# 3 - 82 x 30 mm  
95 x 38 mm  
16.5 cm / 6 1/2"

# Gynecology



Set of 3 Pieces

SIMS  
NF.05.20.03  
18 cm/ 7 1/8"

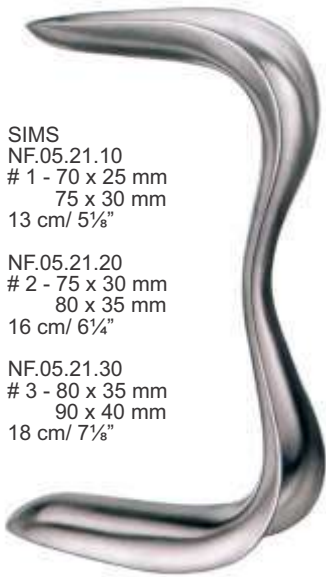

SIMS  
NF.05.21.10  
# 1 - 70 x 25 mm  
75 x 30 mm  
13 cm/ 5 1/8"

NF.05.21.20  
# 2 - 75 x 30 mm  
80 x 35 mm  
16 cm/ 6 1/4"

NF.05.21.30  
# 3 - 80 x 35 mm  
90 x 40 mm  
18 cm/ 7 1/8"



KALLMORGEN  
NF.05.22.07  
# 1 - 70 x 33 mm  
18.5 cm/ 7 1/4"

NF.05.22.09  
# 2 - 90 x 33 mm  
21.5 cm/ 8 1/2"



KALLMORGEN  
NF.05.22.40  
# 1 - 70 x 40 mm  
18.5 cm/ 7 1/4"

NF.05.22.55  
# 2 - 90 x 40 mm  
21.5 cm/ 8 1/2"



set complete

KALLMORGEN  
NF.05.22.70  
# 1 - 70 x 40 mm  
18.5 cm/ 7 1/4"

NF.05.22.90  
# 2 - 90 x 40 mm  
21.5 cm/ 8 1/2"

# Gynecology

NF.05.23.01 - Small  
NF.05.23.02 - Medium  
NF.05.23.03 - Large



**COLLIN**  
NF.05.23.25 90 x 25 mm  
NF.05.23.27 90 x 27 mm  
NF.05.23.29 90 x 29 mm  
NF.05.23.32 90 x 32 mm  
NF.05.23.33 100 x 32 mm  
NF.05.23.34 110 x 34 mm  
NF.05.23.35 100 x 35 mm  
NF.05.23.36 110 x 36 mm  
NF.05.23.38 100 x 38 mm  
NF.05.23.40 100 x 40 mm  
NF.05.23.41 110 x 40 mm



**COLLIN**  
NF.05.24.16 90 X 16 mm  
NF.05.24.20 65 X 20 mm

for virgins



**COLLIN-LANDAU**  
NF.05.25.30 90 x 30 mm  
NF.05.25.35 100 x 35 mm  
NF.05.25.37 110 x 40 mm

for children



**COLLIN**  
NF.05.26.00  
55 x 10 mm



**GRAVES MODIF.**  
NF.05.27.45  
115 x 35 mm  
45°



**GRAVES MODIF.**  
NF.05.27.90  
115 x 35 mm  
90°

# Gynecology



**SEMM**  
NF.05.28.18 90 x 14 mm - 18 mm  
NF.05.28.20 100 x 17 mm - 20 mm  
NF.05.28.30 110 x 25 mm - 30 mm



**PEDIERSON**  
NF.05.29.13 76 x 13 mm  
NF.05.29.22 100 x 22 mm  
NF.05.29.25 120 x 25 mm



**GRAVES**  
NF.05.30.20 75 x 20 mm  
NF.05.30.30 100 x 30 mm  
NF.05.30.35 115 x 35 mm



**SEYFFERT**  
NF.05.31.17 100 x 17 mm  
NF.05.31.33 110 x 33 mm



**CUSCO**  
NF.05.32.17 75 x 17 mm  
for virgins



**CUSCO**  
NF.05.32.32 75 x 32 mm  
NF.05.32.36 85 x 36 mm  
NF.05.32.37 95 x 37 mm  
NF.05.32.38 100 x 37 mm



CUSCO  
NF.05.32.62 15 x 95 mm  
NF.05.32.63 25 x 100 mm  
NF.05.32.65 30 x 120 mm  
NF.05.32.66 35 x 105 mm



Swiss pattern

CUSCO  
NF.05.33.25 90 x 23 mm - 25 mm  
NF.05.33.27 100 x 25 mm - 27 mm  
NF.05.33.30 110 x 27 mm - 30 mm



TRELAT  
NF.05.34.01 85 x 33 mm  
NF.05.34.02 95 x 35 mm  
NF.05.34.03 115 x 43 mm



CUSCO  
NF.05.34.32 75 x 32 mm  
NF.05.34.36 85 x 36 mm  
NF.05.34.37 95 x 37 mm  
NF.05.34.38 100 x 35 mm

# Gynecology

for virgins



CUSCO  
NF.05.34.75  
75 x 17 mm



NOTT  
NF.05.34.81 90 x 30 mm  
NF.05.34.82 110 x 30 mm



BOZEMANN  
NF.05.37.38 80 x 30 mm  
NF.05.37.42 85 x 33 mm  
NF.05.37.45 100 x 35 mm  
NF.05.37.50 110 x 42 mm



BOZEMANN  
NF.05.37.55 70 x 30 mm  
NF.05.37.56 85 x 35 mm  
NF.05.37.57 90 x 35 mm  
NF.05.37.58 110 x 42 mm



BOZEMANN  
NF.05.36.01  
23 cm/ 9"  
MOD. A



BOZEMANN  
NF.05.36.02  
24 cm/ 9½"  
MOD. B

BOZEMANN  
NF.05.36.00

Vaginal speculum, set complete, consisting of:  
1 Handle mod. A NoNF.05.36.01  
1 Handle mod. B NoNF.05.36.02  
8 Speculum blades NdNF.05. 37.38 - NF.05.37.58



**BREISKY**

28-31 cm - 11"-12 $\frac{1}{8}$ "

NF.05.35.01	70 x 25 mm	NF.05.35.02	100 x 20 mm
NF.05.35.03	80 x 25 mm	NF.05.35.04	100 x 25 mm
NF.05.35.05	90 x 25 mm	NF.05.35.06	100 x 30 mm
NF.05.35.07	100 x 10 mm	NF.05.35.08	100 x 35 mm
NF.05.35.09	100 x 15 mm	NF.05.35.10	100 x 40 mm

NF.05.35.11	110 x 20 mm	NF.05.35.21	120 x 20 mm
NF.05.35.12	110 x 25 mm	NF.05.35.22	120 x 25 mm
NF.05.35.13	110 x 30 mm	NF.05.35.23	120 x 30 mm
NF.05.35.19	120 x 10 mm	NF.05.35.24	120 x 35 mm
NF.05.35.20	120 x 15 mm	NF.05.35.25	120 x 40 mm

Vienna pattern



**BREISKY**

32-42 cm - 12 $\frac{1}{2}$ "-16 $\frac{1}{2}$ "

NF.05.36.31	130 x 20 mm	NF.05.36.55	155 x 40 mm
NF.05.36.32	130 x 25 mm	NF.05.36.63	160 x 30 mm
NF.05.36.33	130 x 30 mm	NF.05.36.66	160 x 45 mm
NF.05.36.34	130 x 35 mm	NF.05.36.73	170 x 30 mm
NF.05.36.35	130 x 40 mm	NF.05.36.74	170 x 35 mm

NF.05.36.44	140 x 35 mm	NF.05.36.85	180 x 40 mm
NF.05.36.45	140 x 40 mm	NF.05.36.91	200 x 25 mm
NF.05.36.46	140 x 45 mm	NF.05.36.92	220 x 25 mm
NF.05.36.52	150 x 25 mm	NF.05.36.94	220 x 35 mm
NF.05.36.53	150 x 30 mm	NF.05.36.95	220 x 40 mm
NF.05.36.54	150 x 35 mm	NF.05.36.96	240 x 20 mm

Vienna pattern



**LANDAU**

29 cm/ 11 $\frac{1}{2}$ "

NF.05.36.97	100 x 28 mm
NF.05.36.98	110 x 38 mm

# Gynecology

- NF.05.38.01 1 mm
- NF.05.38.02 2 mm
- NF.05.38.03 3 mm
- NF.05.38.04 4 mm
- NF.05.38.05 5 mm
- NF.05.38.06 6 mm
- NF.05.38.07 7 mm
- NF.05.38.08 8 mm
- NF.05.38.09 9 mm
- NF.05.38.10 10 mm
- NF.05.38.11 11 mm
- NF.05.38.12 12 mm
- NF.05.38.13 13 mm
- NF.05.38.14 14 mm
- NF.05.38.15 15 mm
- NF.05.38.16 16 mm
- NF.05.38.17 17 mm
- NF.05.38.18 18 mm
- NF.05.38.19 19 mm
- NF.05.38.20 20 mm
- NF.05.38.21 21 mm
- NF.05.38.22 22 mm
- NF.05.38.23 23 mm
- NF.05.38.24 24 mm
- NF.05.38.25 25 mm
- NF.05.38.26 26 mm



HEGAR

- NF.05.39.01 1.5 mm
- NF.05.39.02 2.5 mm
- NF.05.39.03 3.5 mm
- NF.05.39.04 4.5 mm
- NF.05.39.05 5.5 mm
- NF.05.39.06 6.5 mm
- NF.05.39.07 7.5 mm
- NF.05.39.08 8.5 mm
- NF.05.39.09 9.5 mm
- NF.05.39.10 10.5 mm
- NF.05.39.11 11.5 mm
- NF.05.39.12 12.5 mm
- NF.05.39.13 13.5 mm
- NF.05.39.14 14.5 mm
- NF.05.39.15 15.5 mm
- NF.05.39.16 16.5 mm
- NF.05.39.17 17.5 mm
- NF.05.39.18 18.5 mm
- NF.05.39.19 19.5 mm
- NF.05.39.20 20.5 mm
- NF.05.39.21 21.5 mm
- NF.05.39.22 22.5 mm



**NF.05.38.40**  
Set of 14 HEGAR uterine dilators, 4 - 17 mm, in cardboard box

**NF.05.38.41**  
Set of 26 HEGAR uterine dilators, 1 - 26 mm, in cardboard box



**NF.05.38.44**  
Set of 14 HEGAR uterine dilators, 4 - 17 mm, in metal case.

**NF.05.38.45**  
Set of 26 HEGAR uterine dilators, 1 - 26 mm, in metal case.

- NF.05.40.01 1 + 2 mm
- NF.05.40.03 3 + 4 mm
- NF.05.40.05 5 + 6 mm
- NF.05.40.07 7 + 8 mm
- NF.05.40.09 9 + 10 mm
- NF.05.40.11 11 + 12 mm
- NF.05.40.13 13 + 14 mm
- NF.05.40.15 15 + 16 mm
- NF.05.40.17 17 + 18 mm
- NF.05.40.19 19 + 20 mm
- NF.05.40.21 21 + 22 mm
- NF.05.40.23 23 + 24 mm
- NF.05.40.25 25 + 26 mm



HEGAR



**NF.05.38.42**  
Set of 14 HEGAR uterine dilators, 4 - 17 mm, in black pouch.

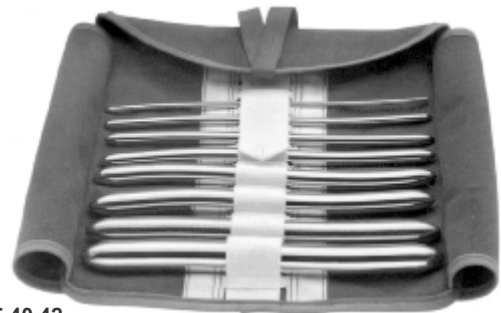

**NF.05.40.42**  
Set of 8 HEGAR uterine dilators, 3 + 4 mm - 17 + 18 in carrying case.



# Gynecology



HANK

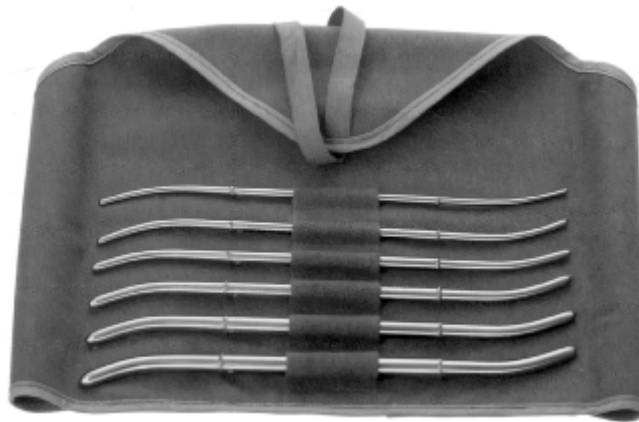

**NF.05.40.70**  
Set of 6 HANK uterine dilators,  
# 9/10-19/20, in canvas roll.

- |                    |                      |
|--------------------|----------------------|
| <b>NF.05.40.50</b> | # 9/10 (4½ + 5 mm)   |
| <b>NF.05.40.52</b> | # 11/12 (5½ + 6 mm)  |
| <b>NF.05.40.54</b> | # 13/14 (6½ + 7 mm)  |
| <b>NF.05.40.56</b> | # 15/16 (7½ + 8 mm)  |
| <b>NF.05.40.58</b> | # 17/18 (8½ + 9 mm)  |
| <b>NF.05.40.60</b> | # 19/20 (9½ + 10 mm) |



PARTT

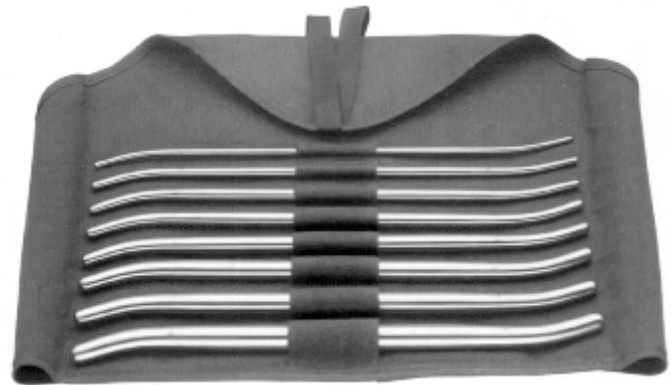

**NF.05.40.92**  
Set of 8 PRATT uterine dilators,  
# 13/15 - 41/43, in canvas roll.

- |                    |                         |
|--------------------|-------------------------|
| <b>NF.05.40.73</b> | # 13/15 ( 4½ + 5 mm)    |
| <b>NF.05.40.75</b> | # 17/19 ( 5⅓ + 1⅙ mm)   |
| <b>NF.05.40.77</b> | # 21/23 ( 7 + ⅔ mm)     |
| <b>NF.05.40.79</b> | # 25/27 ( 8⅓ + 9 mm)    |
| <b>NF.05.40.81</b> | # 29/31 ( 9⅔ + 10⅓ mm)  |
| <b>NF.05.40.83</b> | # 33/35 ( 11 + ⅔ mm)    |
| <b>NF.05.40.85</b> | # 37/39 ( 12½ + 13 mm)  |
| <b>NF.05.40.87</b> | # 41/43 ( 13⅓ + 14⅓ mm) |

# Gynecology



- NF.05.42.01 1 mm
- NF.05.42.02 2 mm
- NF.05.42.03 3 mm
- NF.05.42.04 4 mm
- NF.05.42.05 5 mm
- NF.05.42.06 6 mm
- NF.05.42.07 7 mm
- NF.05.42.08 8 mm
- NF.05.42.09 9 mm
- NF.05.42.10 10 mm
- NF.05.42.11 11 mm
- NF.05.42.12 12 mm
- NF.05.42.13 13 mm
- NF.05.42.14 14 mm
- NF.05.42.15 15 mm
- NF.05.42.16 16 mm
- NF.05.42.17 17 mm
- NF.05.42.18 18 mm
- NF.05.42.19 19 mm
- NF.05.42.20 20 mm
- NF.05.42.21 21 mm
- NF.05.42.22 22 mm
- NF.05.42.23 23 mm
- NF.05.42.24 24 mm
- NF.05.42.25 25 mm
- NF.05.42.26 26 mm

HEGAR  
with serrated handle



30 cm/ 11¾"  
NF.05.43.30 corrugated ends  
NF.05.43.33 smooth ends



NF.05.43.30  
NF.05.44.30



NF.05.43.33  
NF.05.44.33



WYLIE  
30 cm/ 11¾"  
NF.05.44.30 corrugated ends  
NF.05.44.33 smooth ends

# Gynecology



SCHERBACK  
NF.05.45.61 80 x 30 mm  
NF.05.45.62 85 x 35 mm  
NF.05.45.63 90 x 40 mm



SCHERBACK  
NF.05.45.64 55 x 40 - 60 mm  
NF.05.45.65 70 x 45 - 70 mm

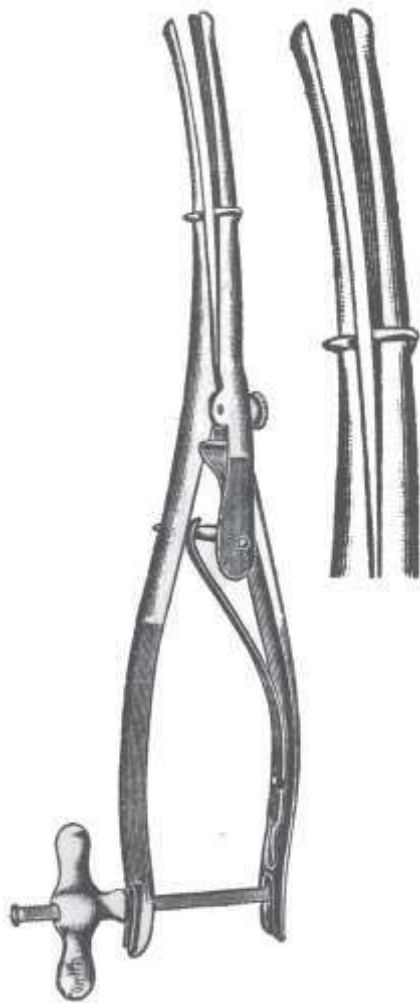

SIMS  
NF.05.45.28  
28 cm / 11"



SCHERBACK  
NF.05.45.75  
19 cm - 7½"

SCHERBACK  
NF.05.45.60  
Vaginal Speculum,  
Set complete



SCHERBACK  
NF.05.45.77 400 g  
NF.05.45.78 600 g

# Gynecology

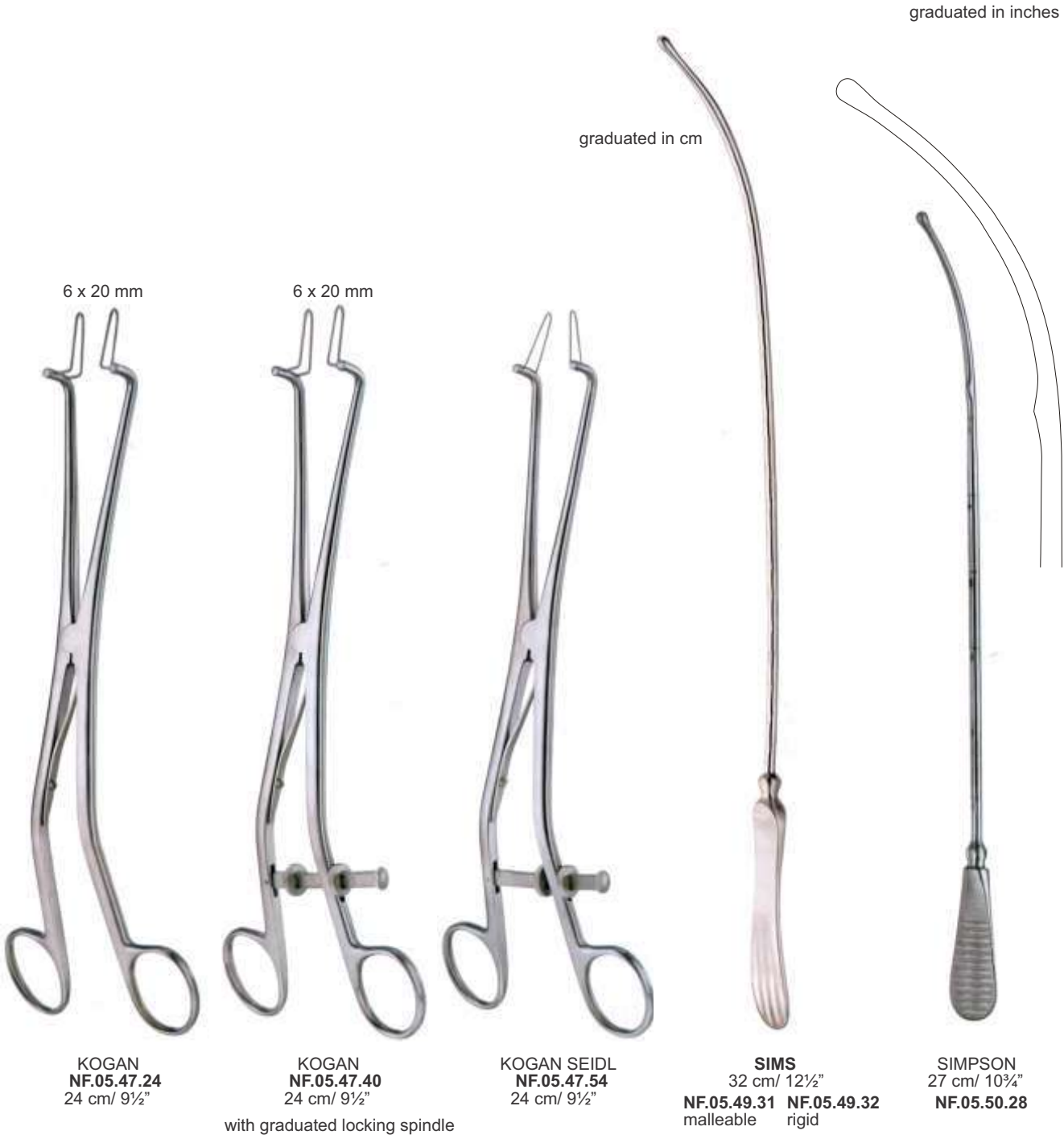

6 x 20 mm

6 x 20 mm

graduated in cm

graduated in inches

**KOGAN**  
**NF.05.47.24**  
24 cm/ 9½"

**KOGAN**  
**NF.05.47.40**  
24 cm/ 9½"  
with graduated locking spindle

**KOGAN SEIDL**  
**NF.05.47.54**  
24 cm/ 9½"

**SIMS**  
32 cm/ 12½"  
**NF.05.49.31** malleable  
**NF.05.49.32** rigid

**SIMPSON**  
27 cm/ 10¾"  
**NF.05.50.28**

# Gynecology



VALLEIX  
28 cm / 11"  
NF.05.51.25  
rigid

EMMET (SIMS)  
NF.05.52.30  
30 cm / 12"

MARTIN  
30 cm / 11¾"  
NF.05.53.30 NF.05.53.32  
rigid malleable

SIMPSON  
27 cm / 10¾"  
NF.05.54.33  
malleable

SIMS  
26.5 cm / 10½"  
NF.05.56.26  
malleable

# Gynecology

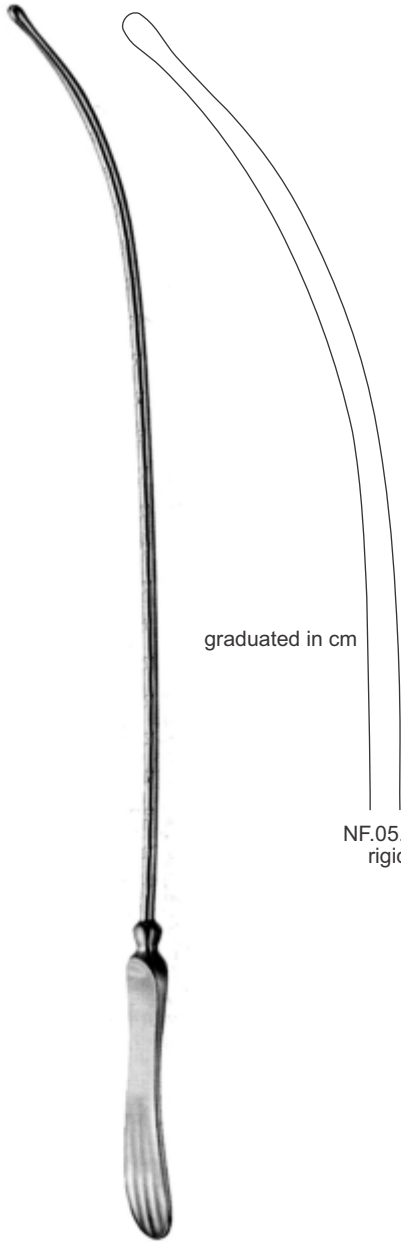

**SIMS**  
32 cm - 12½"



**BRAUN**



NF.05.57.15  
28.5 cm / 11¼"



NF.05.57.25  
26 cm / 10¼"



NF.05.57.35  
27cm / 10¾"

# Gynecology



**BRAUN**  
NF.05.58.27  
27 cm/ 10½"

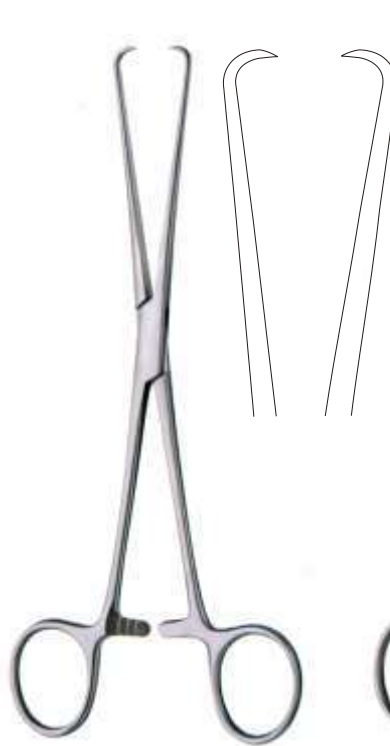

**BARRETT**  
NF.05.62.18  
18 cm/ 7¼"



**ADAIR**  
NF.05.62.19  
19 cm/ 7½"



**SCHROEDER**  
NF.05.63.25  
25 cm/ 10"



**SCHROEDER**  
NF.05.63.26  
25 cm/ 10"

# Gynecology



**POZZI**  
**NF.05.65.25**  
25.5 cm/ 10"



**BRAUN**  
**NF.05.67.25**  
25 cm/ 10"



**MARTIN**  
**NF.05.66.26**  
26.5 cm/ 10½"



**ABEL**  
**NF.05.68.27**  
27 cm/ 10¾"





**POZZI**  
**NF.05.69.25**  
25 cm/ 10"

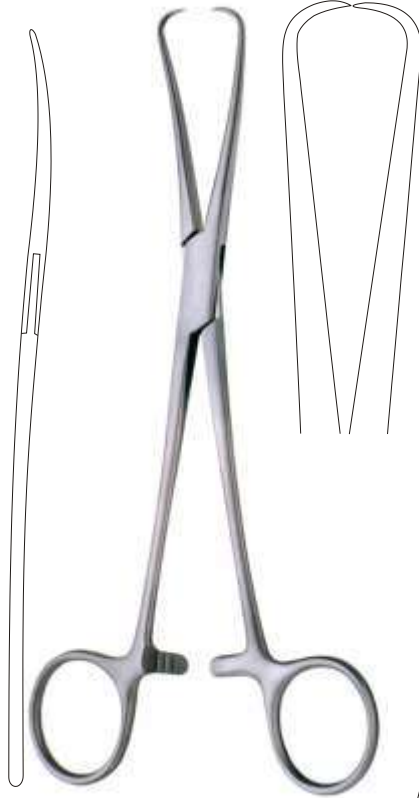
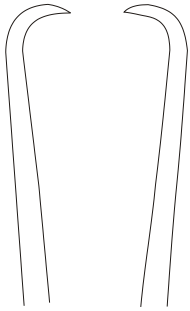

**JARCHO**  
**NF.05.71.20**  
20 cm/ 8"

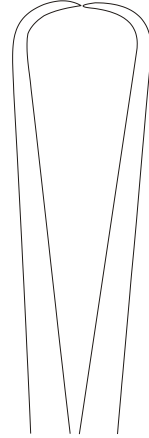

**POZZI-PALMER**  
**NF.05.70.25**  
25 cm/ 10"

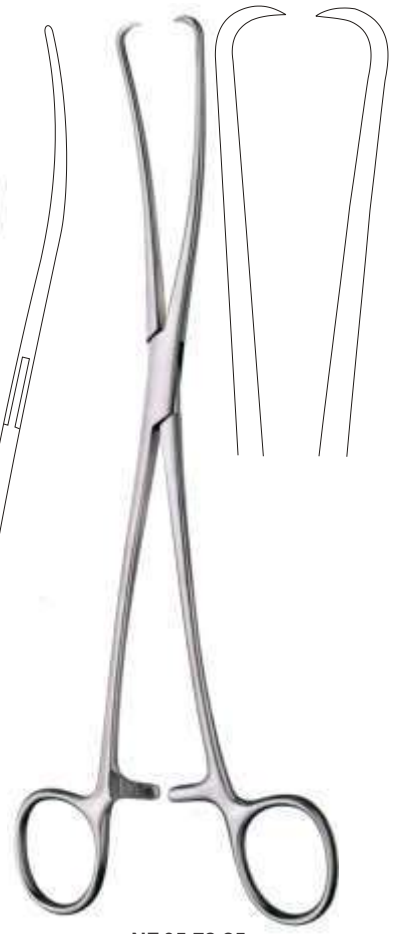
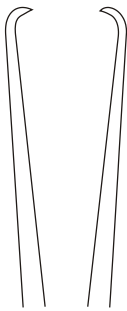

**NF.05.72.25**  
25 cm/ 10"

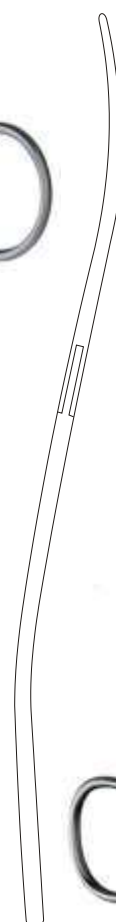

**Gynecology**



**GORDON**  
**NF.05.73.24**  
24 cm/ 9½"

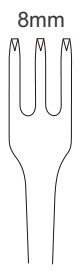

**Nawrooz**  
**NF.05.74.24**  
24 cm/ 9½"

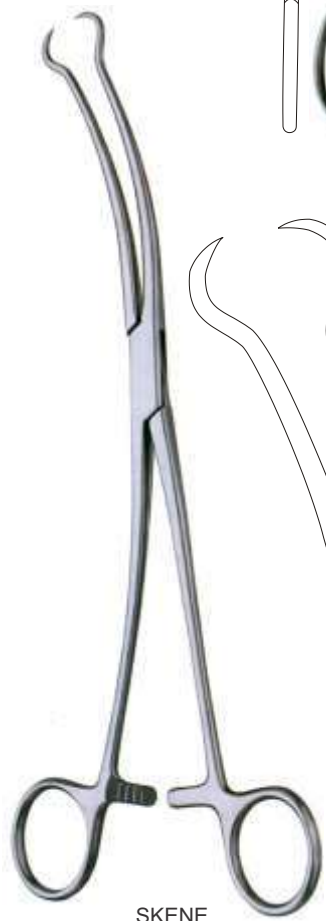
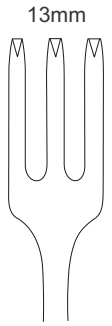

**SKENE**  
**NF.05.76.24**  
24 cm/ 9½"

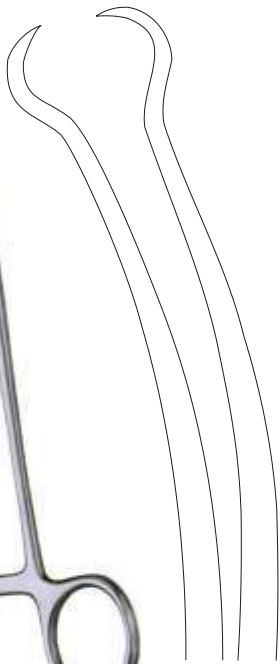

**KAHN**  
**NF.05.75.24**  
24 cm/ 9½"

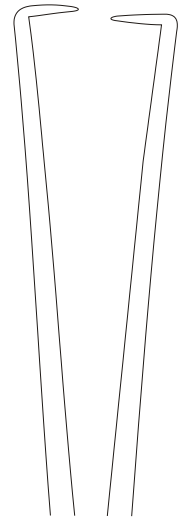

# Gynecology

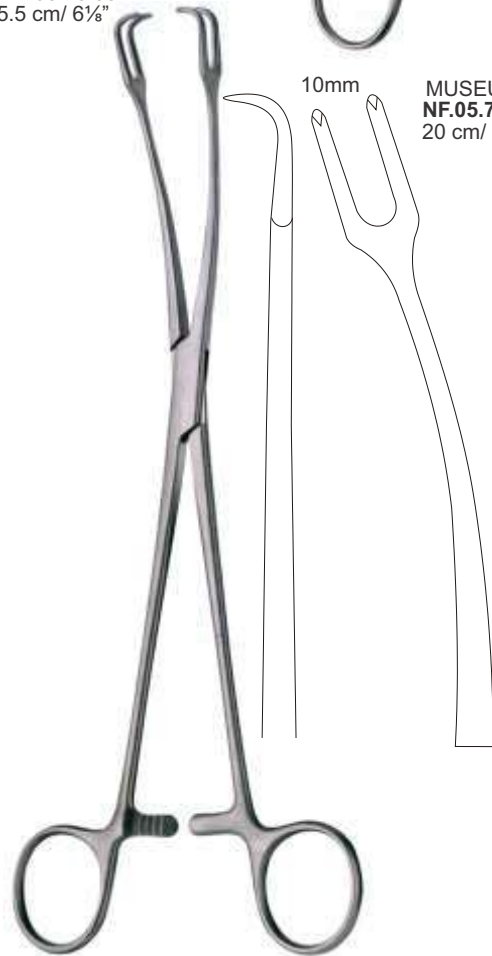

# Gynecology



JACOBS  
NF.05.80.21  
21 cm / 8 1/4"

JACOBS  
NF.05.81.21  
21 cm / 8 1/4"

PRATT  
NF.05.82.26  
26 cm / 10 1/4"

BILLROTH  
(PRATT)  
NF.05.83.27  
27 cm / 10 3/4"



TEALE  
NF.05.98.23  
23 cm/ 9"



TEALE  
NF.05.98.33  
23 cm/ 9"

# Gynecology



# Gynecology



**MUSEUX**  
26 cm / 10 $\frac{1}{4}$ "



NF.05.104.06  
# 1 - 9 mm



NF.05.104.07  
# 2 - 11 mm

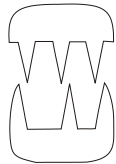

NF.05.104.11  
# 3 - 13 mm



**DOYEN**  
NF.05.105.20  
20 cm / 8"

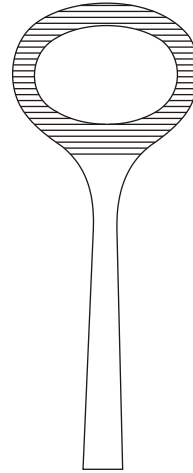

27 mm



**NOTO**  
NF.05.106.27  
27 cm / 10 $\frac{3}{4}$ "

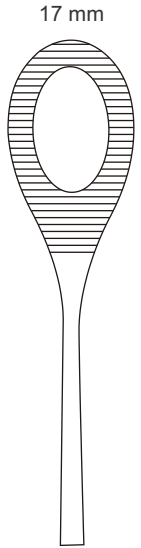

17 mm

# Gynecology

18 mm



**KELLY**  
**NF.05.106.32**  
32 cm / 12½"



**COLLIN**  
**NF.05.107.26**  
26 cm / 10¼"



**KELLY**  
**NF.05.108.26**  
26 cm / 10¼"



# Gynecology



NF.05.109.19  
19.5 cm / 7¾"  
NF.05.109.21  
21 cm / 8¼"  
NF.05.109.23  
23 cm / 9"

HEANEY

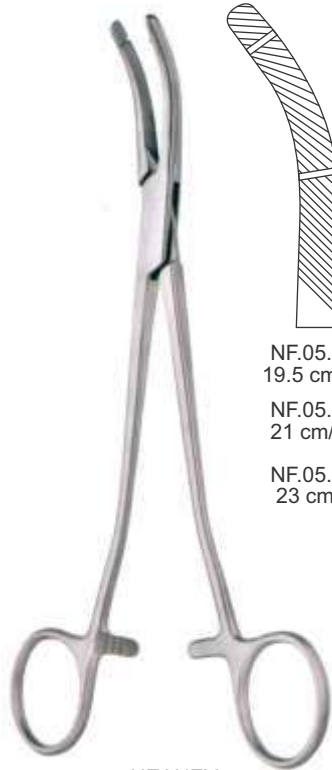

NF.05.110.19  
19.5 cm / 7¾"  
NF.05.110.21  
21 cm / 8¼"  
NF.05.110.23  
23 cm / 9"

HEANEY



HEANEY-REZEK  
NF.05.111.21  
21 cm / 8¼"

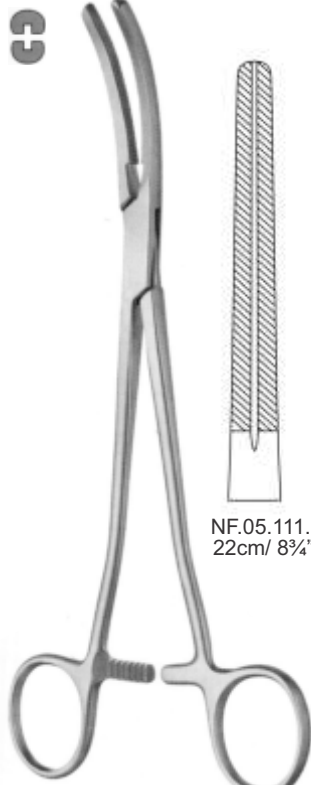

HEANEY "AT"

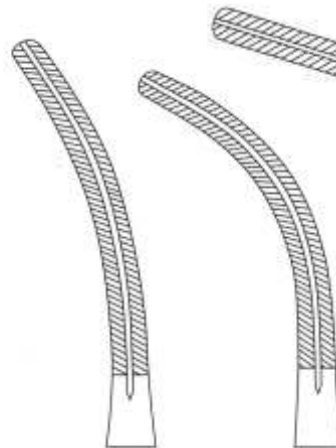

NF.05.111.50  
22cm / 8¾"

NF.05.111.51  
22cm / 8¾"

NF.05.111.53  
22cm / 8¾"

NF.05.111.55  
20cm / 8"

# Gynecology



**SOMER**  
**NF.05.112.24**  
24 cm / 9½"



**DARTIGUES**  
**NF.05.113.26**  
27 cm / 10¾"



**COLLIN**  
**NF.05.113.38**  
28 cm / 11"

# Gynecology

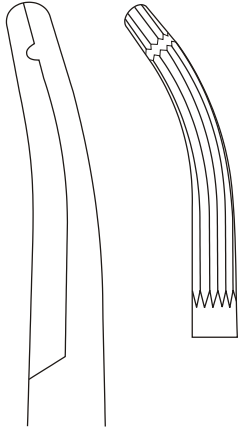

NF.05.115.21

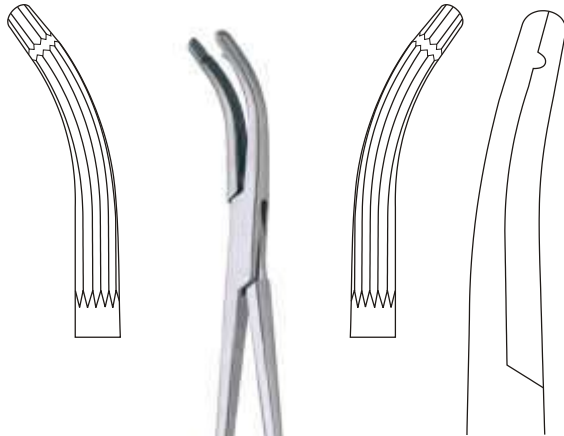

NF.05.114.21

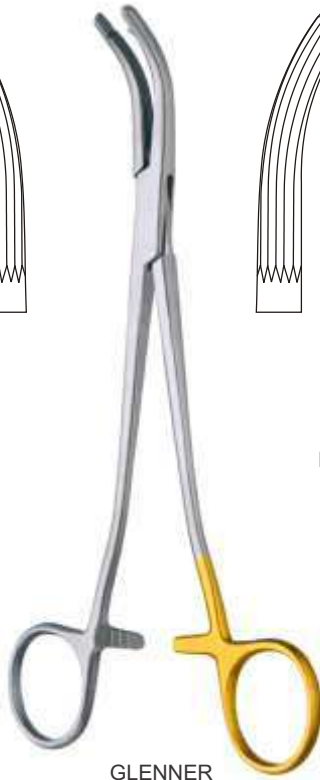

**GLENNER**  
21 cm/ 8¼"

**NF.05.114.20**  
Set (NF.05.114.21+  
NF.05.115.21)

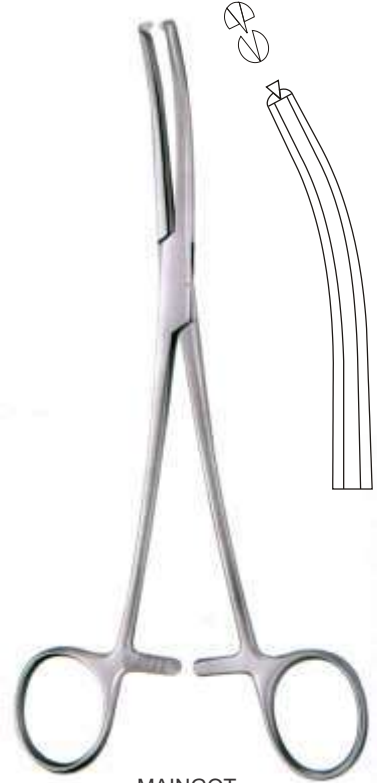

**MAINGOT**  
NF.05.116.20  
20 cm/ 8"

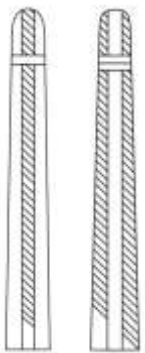

NF.05.116.30

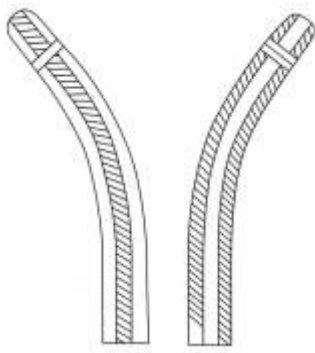

NF.05.116.31

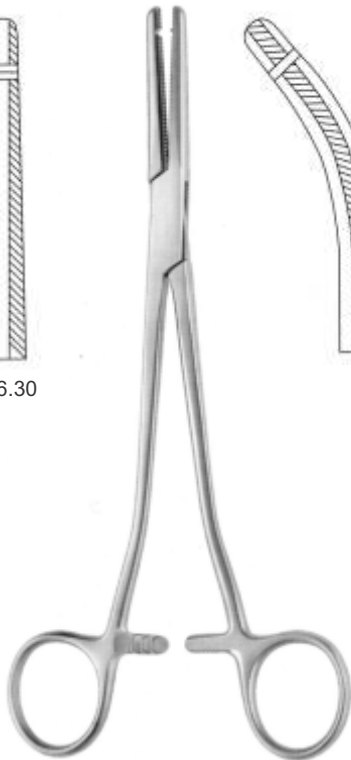

**REICH-NECHTOW**  
21 cm/ 8¼"

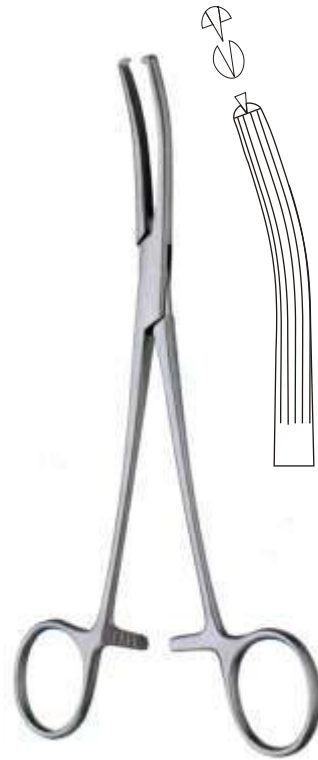

**LONG**  
NF.05.118.19  
19 cm/ 7½"

# Gynecology



**BALLENTINE**  
NF.05.118.31

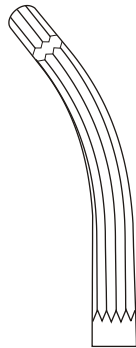

**HEANEY-  
BALLENTINE**  
NF.05.118.32



**FAURE**  
NF.05.120.23  
23 cm / 9"



**SCHUBERT**  
NF.05.121.24  
24 cm / 9½"



VAN DOREN  
NF.05.122.24  
24 cm/ 9½"



THOMS-GAYLOR  
NF.05.123.24  
24 cm/ 9½"



NAWROOZ MEDINA  
NF.05.124.22  
22 cm/ 8¾"



GAYLOR  
NF.05.124.24  
24 cm/ 9½"

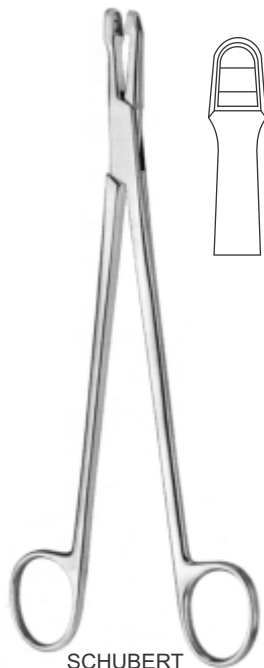

SCHUBERT  
NF.05.125.21  
21 cm/ 8¼"



SCHUBERT  
NF.05.126.21  
21 cm/ 8¼"

# Gynecology

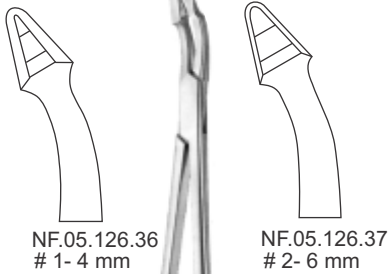

NF.05.126.36  
# 1- 4 mm

NF.05.126.37  
# 2- 6 mm

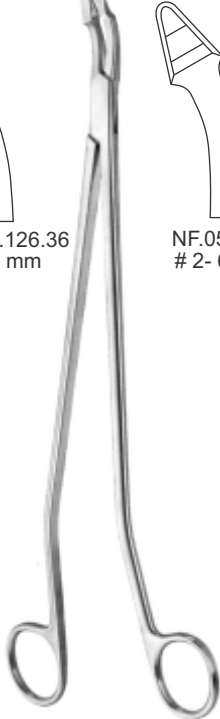

SCHUMACHER-VAN DOREN  
24 cm/ 9½"

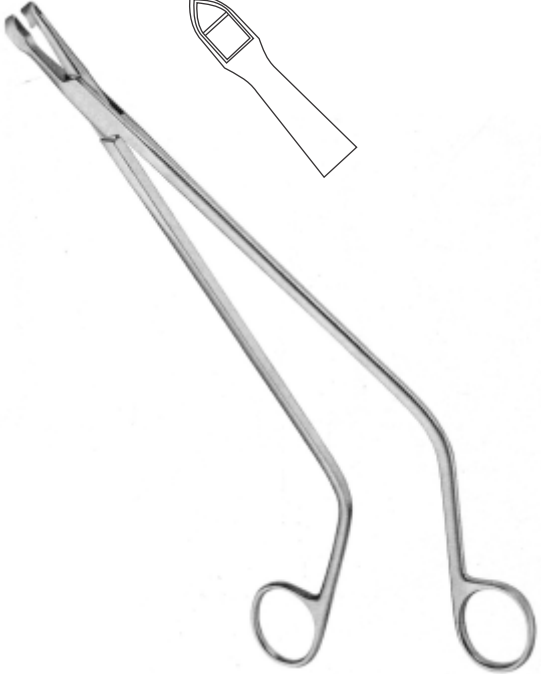

TISCHLER  
NF.05.126.54  
27 cm/ 10¾"



NF.05.127.22  
20 cm-8"  
Cannula only

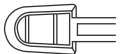

NF.05.127.26  
Biopsy tip only

NF.05.127.20  
Universal handle only



EPPENDORF  
NF.05.127.30

# Gynecology

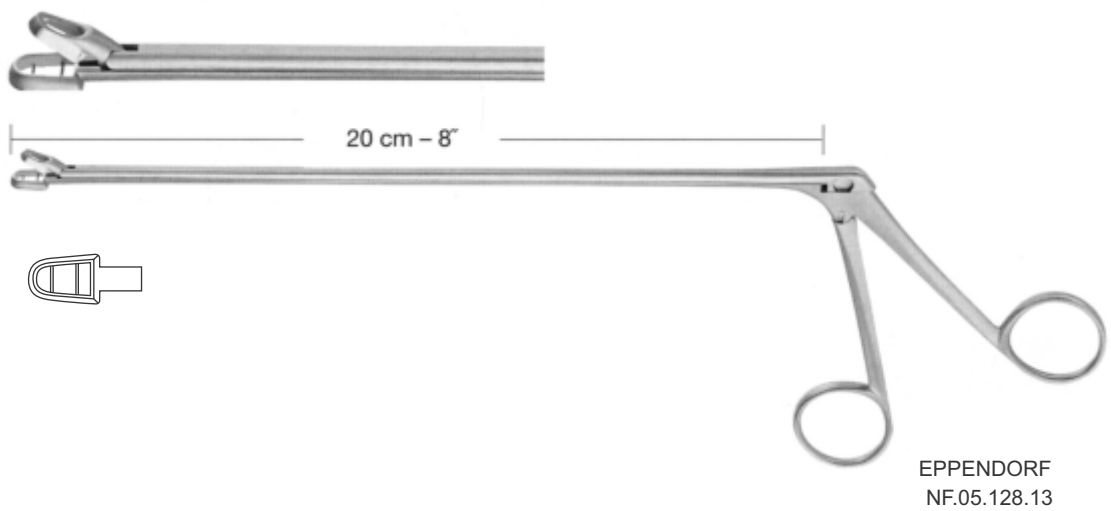
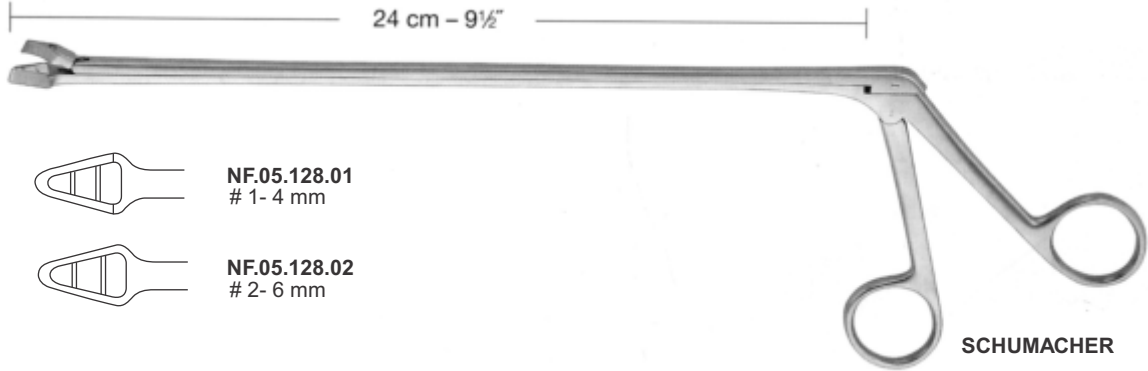

# Gynecology

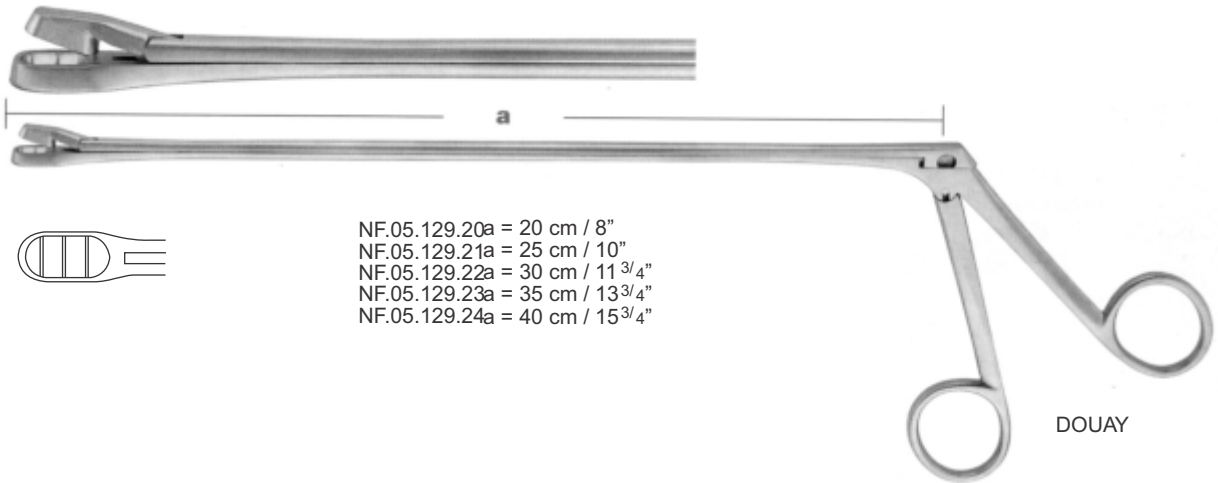

DOUAY

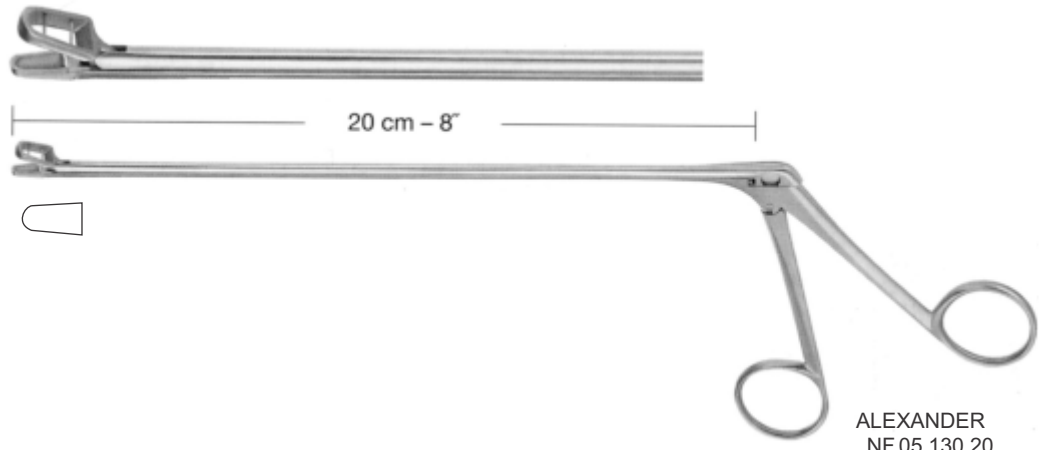

ALEXANDER  
NF.05.130.20

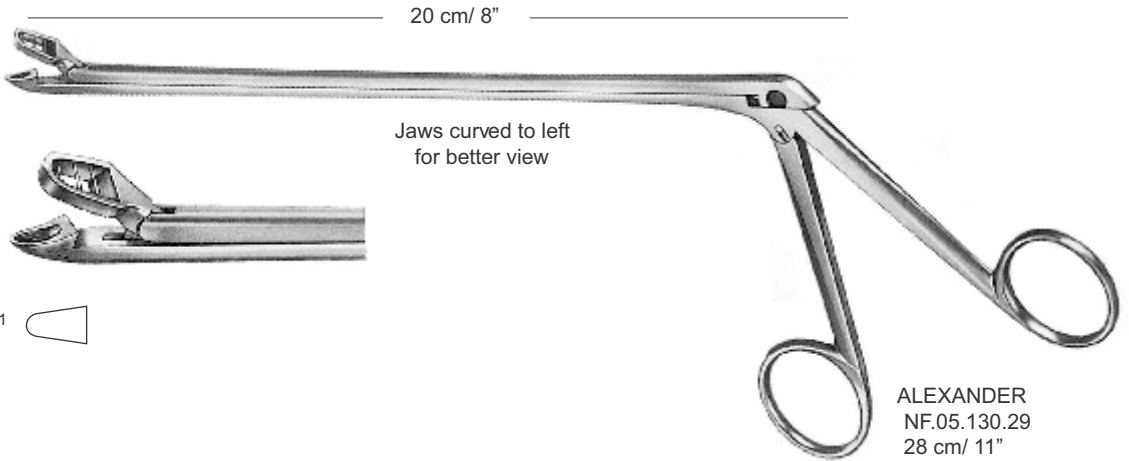

ALEXANDER  
NF.05.130.29  
28 cm / 11"



# Gynecology

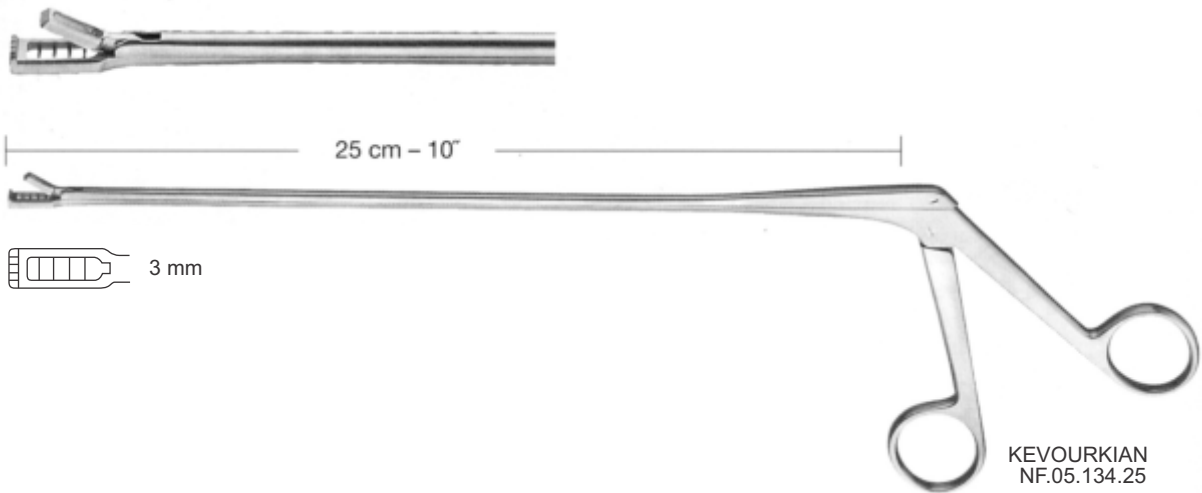
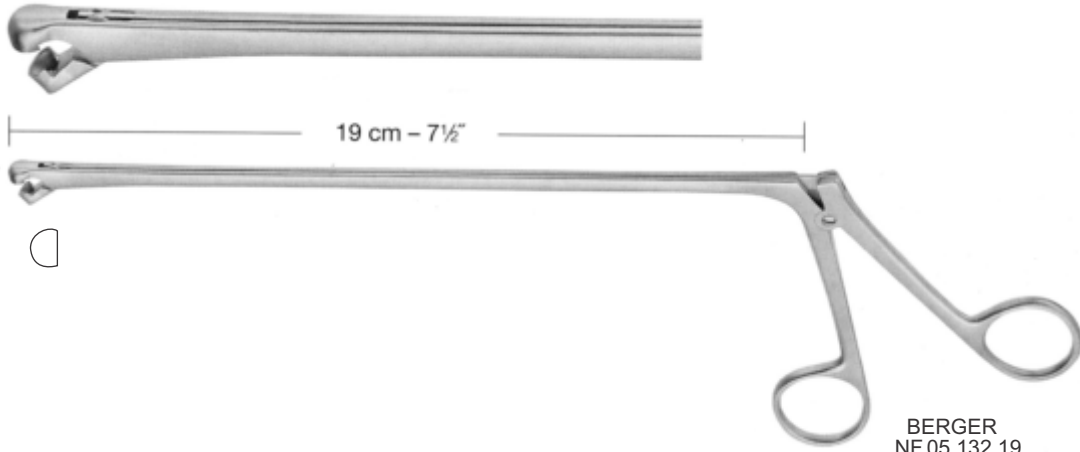

# Gynecology



**COLLIN**  
28 cm/11"



**NF.05.136.08**  
8 mm



**NF.05.136.10**  
10 mm



**NF.05.136.12**  
12 mm

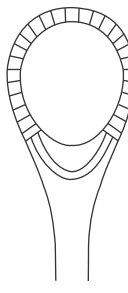

**NF.05.136.14**  
14 mm



**DOYEN**  
NF.05.136.29  
14 cm/ 5½"

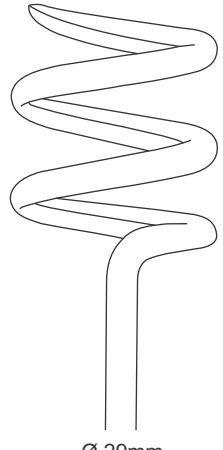

Ø 29mm

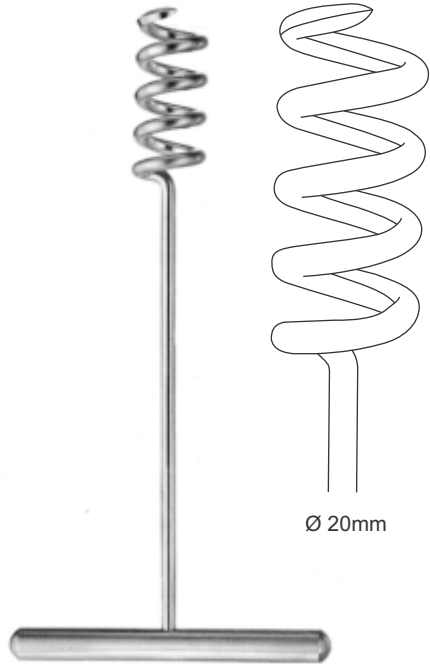

**DOYEN**  
NF.05.136.20  
17 cm/ 6¾"



Ø 20mm



**SEGOND**  
NF.05.136.50  
27 cm/ 10¾"

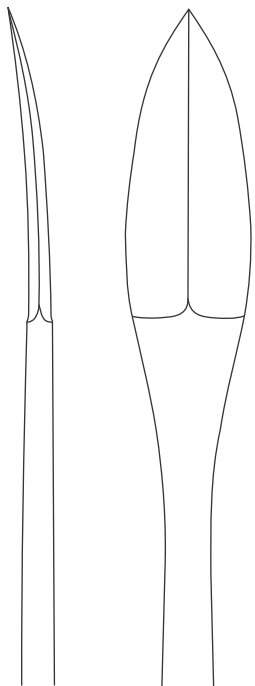

# Gynecology

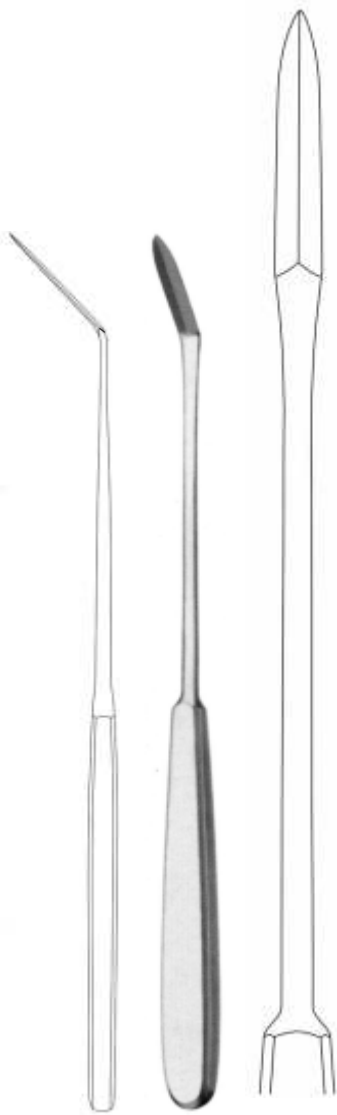

**AYRE**  
NF.05.136.51  
23 cm/ 9"

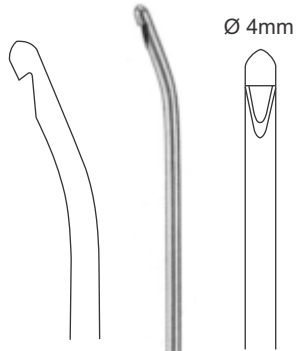

Luer-Lock

**RANDALL**  
NF.05.137.23  
23 cm/ 9"

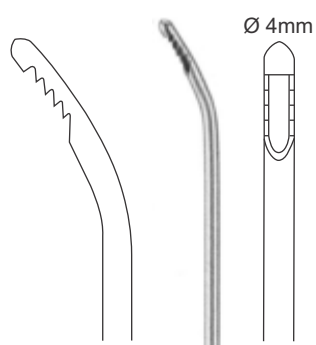

Luer-Lock

**NOVAK**  
NF.05.138.23  
23 cm/ 9"



**KEVOURKIAN-YOUNGE**  
NF.05.139.30  
30 cm/ 11¾"

# Gynecology

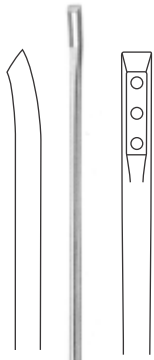

**KEVOURKIAN-YOUNGE**  
NF.05.140.30  
30 cm / 11¾"

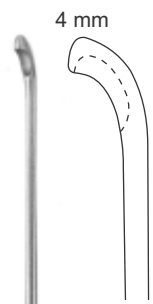

**GENELL**  
NF.05.142.28  
28 cm / 11"

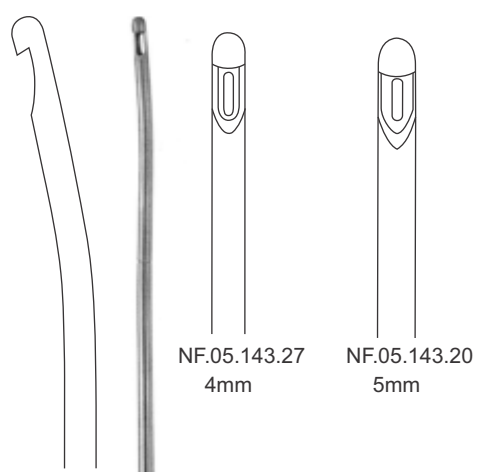

**MOD. MÜNCHEN**  
27 cm / 10¾"

NF.05.143.27  
4mm

NF.05.143.20  
5mm

# Gynecology

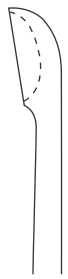

c  
29 cm/ 11½"



NF.05.146.07  
# 1 - 7 mm



NF.05.146.08  
# 2 - 8 mm



NF.05.146.10  
# 3 - 10 mm



NF.05.146.11  
# 4 - 11 mm

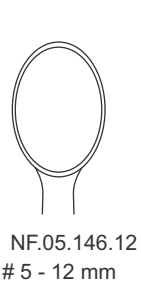

NF.05.146.12  
# 5 - 12 mm

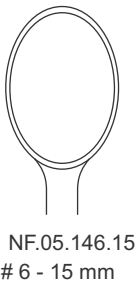

NF.05.146.15  
# 6 - 15 mm



MILAN  
28 cm/ 11"



NF.05.147.04  
# 1 - Ø 4 mm



NF.05.147.06  
# 2 - Ø 6 mm



NF.05.147.09  
# 3 - Ø 9 mm

Slightly malleable

# Gynecology







sharp



rigid

1/2





**SCHROEDER**  
30 cm / 11 3/4"

-  NF.05.148.01  
#1 - 7 mm
-  NF.05.148.02  
#2 - 8 mm
-  NF.05.148.03  
#3 - 10 mm
-  NF.05.148.04  
#4 - 11 mm
-  NF.05.148.05  
#5 - 12 mm
-  NF.05.148.06  
#6 - 15 mm

blunt

malleable

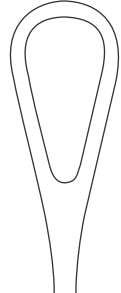
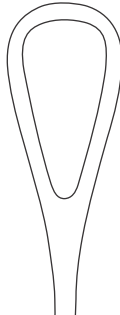

-  NF.05.149.01  
#1 - 10 mm
-  NF.05.149.02  
#2 - 11 mm
-  NF.05.149.03  
#3 - 12 mm
-  NF.05.149.04  
#4 - 13 mm
-  NF.05.149.05  
#5 - 14 mm
-  NF.05.149.06  
#6 - 15 mm

**THOMAS**  
28 cm / 11"

# Gynecology



NF.05.149.14  
4.5 mm  
Fig # 1



NF.05.149.17  
6 mm  
Fig # 2

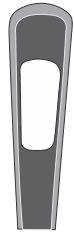

NF.05.149.22  
7.5 mm  
Fig # 3

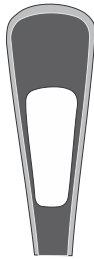

NF.05.149.26  
9 mm  
Fig # 4

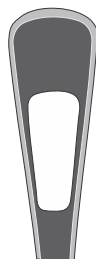

NF.05.149.29  
12 mm  
Fig # 5

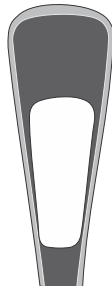

NF.05.149.35  
15 mm  
Fig # 6

J.O.MW UTERINE CURETTES  
28 cm/ 11"



sharp



# 0 - 5 mm



blunt



GOURDET  
28 cm/ 11"



NF.05.152.06  
6 mm



NF.05.152.08  
8 mm



NF.05.152.10  
10 mm



NF.05.152.12  
12 mm



NF.05.152.14  
14 mm

SIMS (HERRERA)  
NF.05.151.80  
25 cm/ 10"

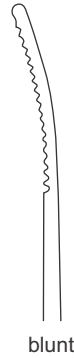

blunt



malleable

GREENE  
28 cm/ 11"

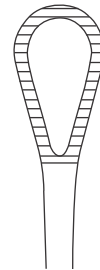

NF.05.151.10  
10 mm

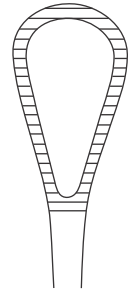

NF.05.151.14  
14 mm

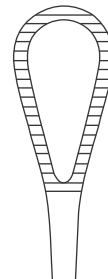

NF.05.151.12  
12 mm

# Gynecology



sharp



SIMS  
24.5 - 26 cm  
9 3/4" - 10 1/4"



NF.05.153.01  
# 1 - 7 mm



NF.05.153.03  
# 3 - 9 mm

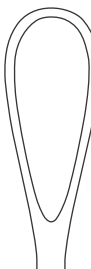

NF.05.153.05  
# 5 - 12 mm



NF.05.153.02  
# 2 - 8 mm



NF.05.153.04  
# 4 - 11 mm

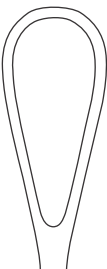

NF.05.153.06  
# 6 - 14 mm



blunt



SIMS  
24.5 - 26 cm  
9 3/4" - 10 1/4"



NF.05.153.07  
# 1 - 7 mm



NF.05.153.09  
# 3 - 9 mm



NF.05.153.12  
# 5 - 12 mm



NF.05.153.08  
# 2 - 8 mm



NF.05.153.11  
# 4 - 11 mm



NF.05.153.14  
# 6 - 14 mm



# Gynecology



sharp



RECAMIER  
31 cm/ 12"



NF.06.155.00  
# 00 - 5 mm



NF.06.155.10  
# 0 - 6 mm



NF.06.155.11  
# 1 - 7 mm



NF.06.155.12  
# 2 - 8 mm



NF.06.155.13  
# 3 - 9 mm



NF.06.155.14  
# 4 - 11 mm



NF.06.155.15  
# 5 - 12 mm

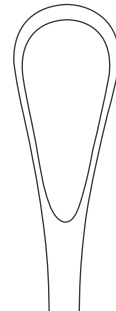

NF.06.155.16  
# 6 - 14 mm



rigid

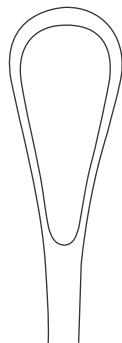

NF.06.155.17  
# 7 - 15 mm

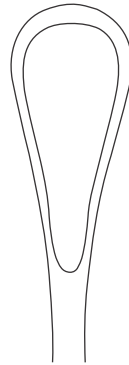

NF.06.155.18  
# 8 - 16 mm

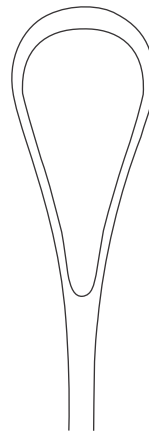

NF.06.155.19  
# 9 - 19 mm

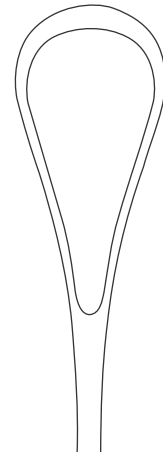

NF.06.155.20  
# 10 - 20 mm

# Gynecology



sharp



**RECAMIER**  
31 cm/ 12"



malleable



NF.06.155.26  
# 0 - 6 mm



NF.06.155.27  
# 1 - 7 mm



NF.06.155.28  
# 2 - 8 mm



NF.06.155.29  
# 3 - 9 mm



NF.06.155.31  
# 4 - 11 mm



NF.06.155.32  
# 5 - 12 mm



NF.06.155.34  
# 6 - 14 mm

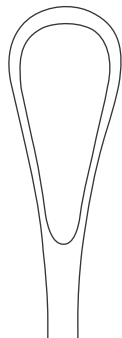

NF.06.155.35  
# 7 - 15 mm

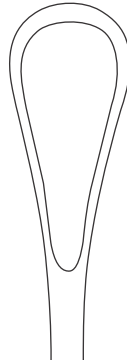

NF.06.155.36  
# 8 - 16 mm

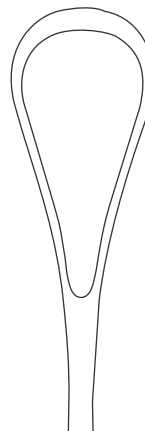

NF.06.155.39  
# 9 - 19 mm

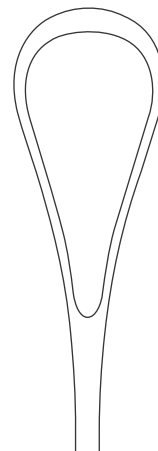

NF.06.155.40  
# 10 - 20 mm

# Gynecology



blunt



rigid



RECAMIER  
31 cm / 12"



NF.06.156.00  
# 00 - 5 mm



NF.06.156.10  
# 0 - 6 mm



NF.06.156.11  
# 1 - 7 mm



NF.06.156.12  
# 2 - 8 mm



NF.06.156.13  
# 3 - 9 mm



NF.06.156.14  
# 4 - 11 mm



NF.06.156.15  
# 5 - 12 mm



NF.06.156.16  
# 6 - 14 mm

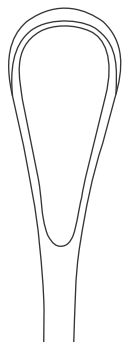

NF.06.156.17  
# 7 - 15 mm

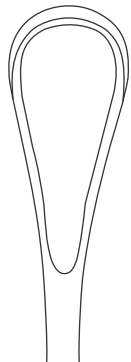

NF.06.156.18  
# 8 - 16 mm

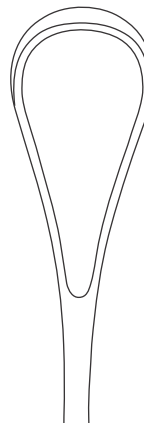

NF.06.156.19  
# 9 - 19 mm

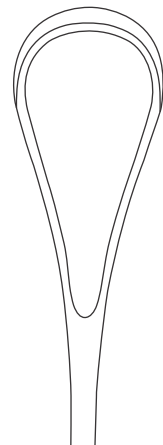

NF.06.156.20  
# 10 - 20 mm

# Gynecology



blunt



RECAMIER  
31 cm/ 12"



malleable



NF.06.156.26  
# 0 - 6 mm



NF.06.156.27  
# 1 - 7 mm



NF.06.156.28  
# 2 - 8 mm



NF.06.156.29  
# 3 - 9 mm



NF.06.156.31  
# 4 - 11 mm



NF.06.156.32  
# 5 - 12 mm

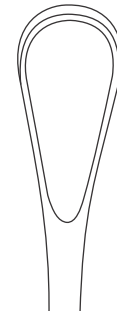

NF.06.156.34  
# 6 - 14 mm



NF.06.156.35  
# 7 - 15 mm

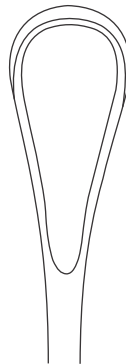

NF.06.156.36  
# 8 - 16 mm

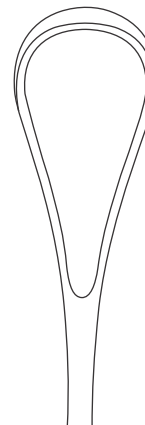

NF.06.156.39  
# 9 - 19 mm

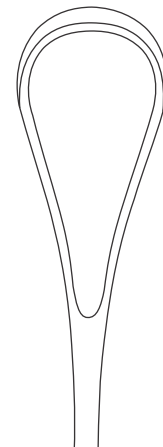

NF.06.156.40  
# 10 - 20 mm

# Gynecology



blunt



malleable

BUMM  
28 - 31cm  
11" - 12"

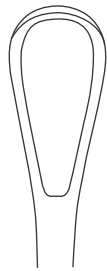

NF.06.158.10  
# 0 - 10 mm

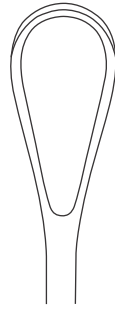

NF.06.158.11  
# 1 - 11 mm

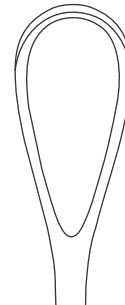

NF.06.158.12  
# 2 - 13 mm

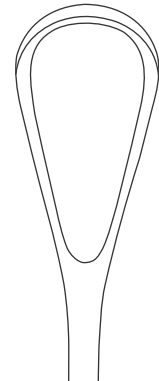

NF.06.158.13  
# 3 - 15 mm

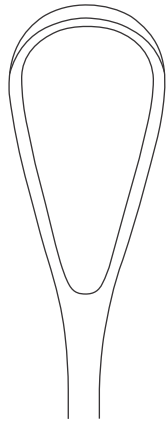

NF.06.158.14  
# 4 - 17 mm

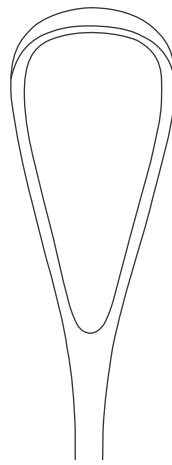

NF.06.158.15  
# 5 - 19 mm

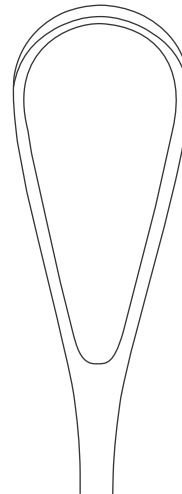

NF.06.158.16  
# 5 - 21 mm

# Gynecology

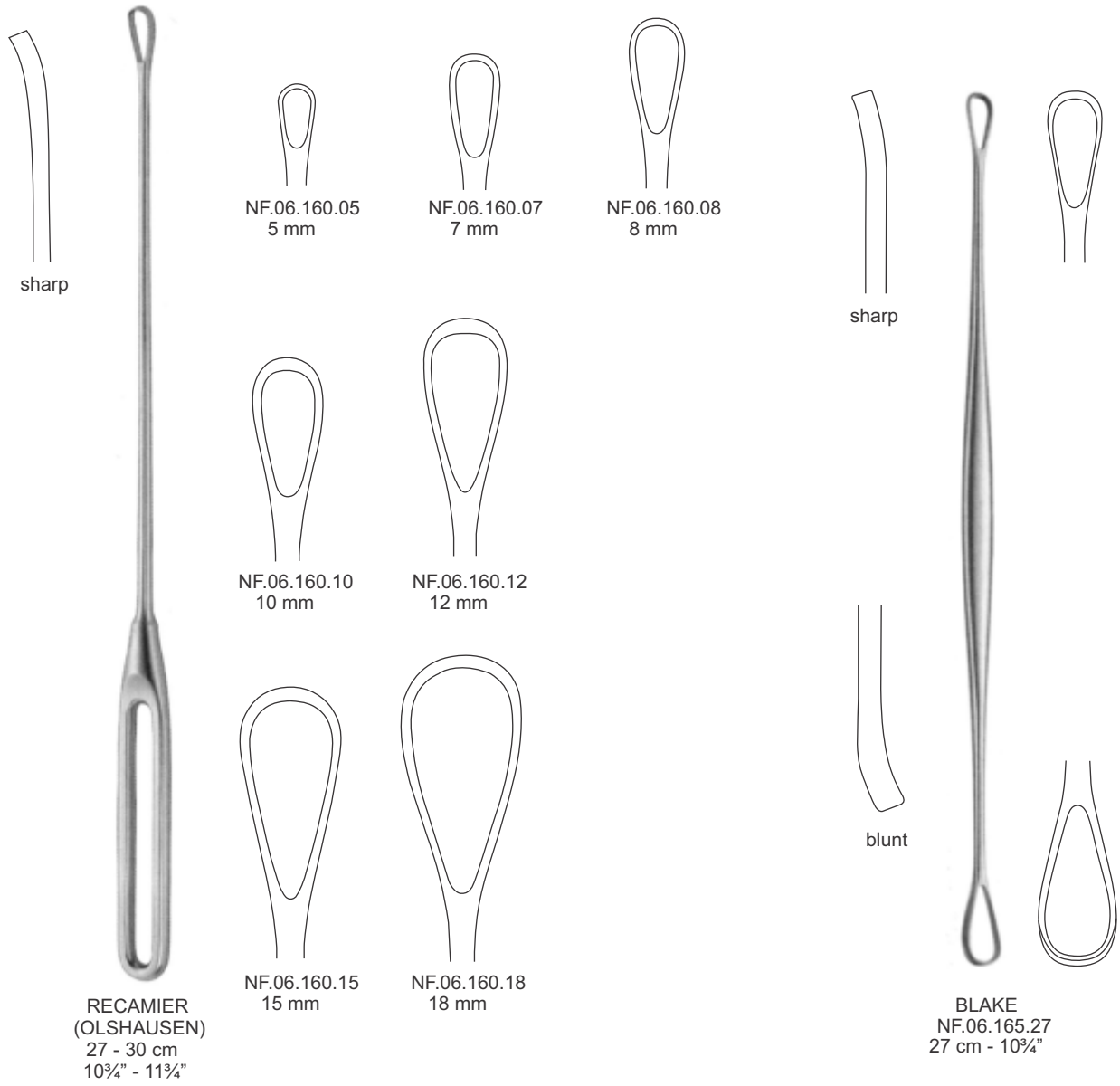



# Obstetrics



graduated in cm and inches

NF.06.01.15



graduated in cm

MARTIN  
NF.06.03.35

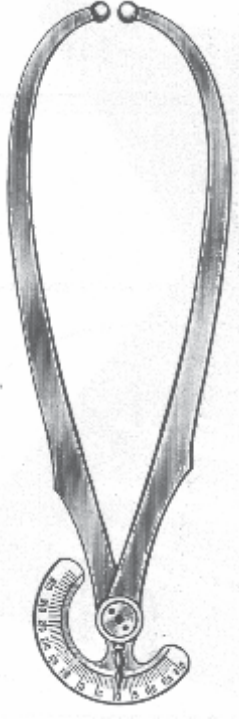

graduated in cm

COLLIN  
NF.06.02.25



# Obstetrics

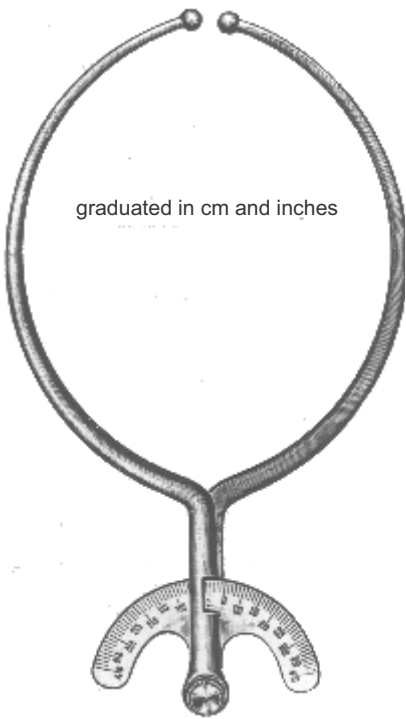

graduated in cm and inches

**BREISKY**  
NF.06.04.45



**DELEE**  
NF.06.05.55  
graduated in cm and inches



Amniotome

**BEACHAM**  
NF.06.06.24  
24 cm/ 9½"

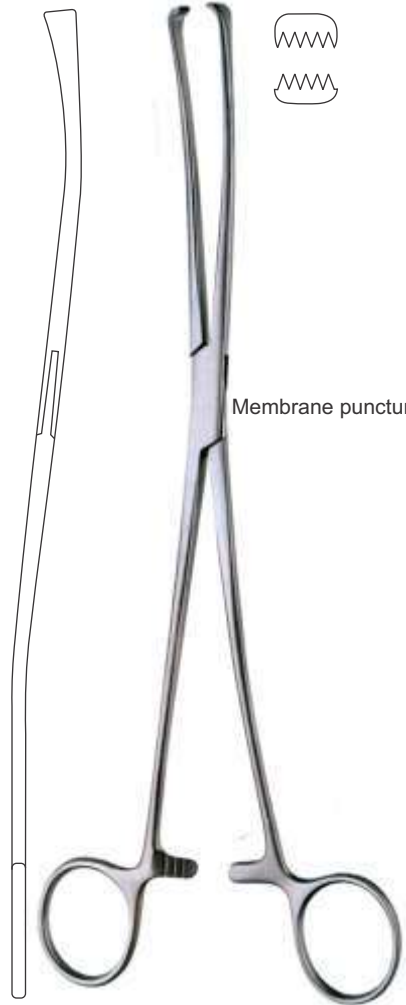

Membrane puncturing

**IOWA**  
NF.06.07.26  
26 cm/ 10¼"



**DEMARTEL**  
NF.06.08.14  
14 cm/ 5½"



**WILLETT**  
NF.06.08.19  
19 cm/ 7½"

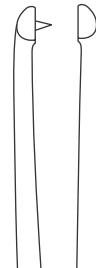
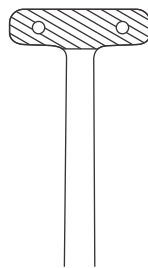

# Obstetrics



**GREEN-ARMYTAGE**  
NF.06.09.22  
20.5 cm / 8"

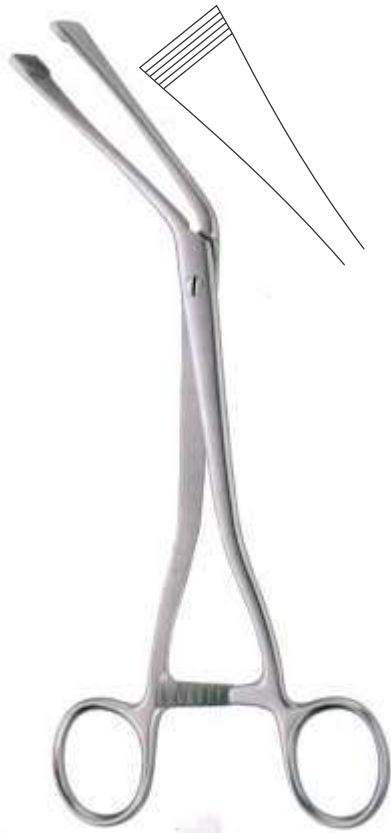

**GREEN-ARMYTAGE**  
NF.06.09.23  
20.5 cm / 8"



**DELEE**  
NF.06.12.36  
36 cm / 14 1/8"



Cannula for trans-vaginal  
anaesthesia of the pudendum

**LUER-LOCK**  
NF.06.10.09  
0.90 x 150 mm



Needle guide (trumpet shaped)

**IOWA**  
NF.06.11.14  
14 cm / 5 1/2"



SIMPSON  
NF.06.13.32 30 cm/ 11 $\frac{1}{4}$ "  
NF.06.13.36 36 cm/ 14 $\frac{1}{8}$ "



LUIKART-SIMPSON  
NF.06.14.36  
36 cm/ 14 $\frac{1}{8}$ "

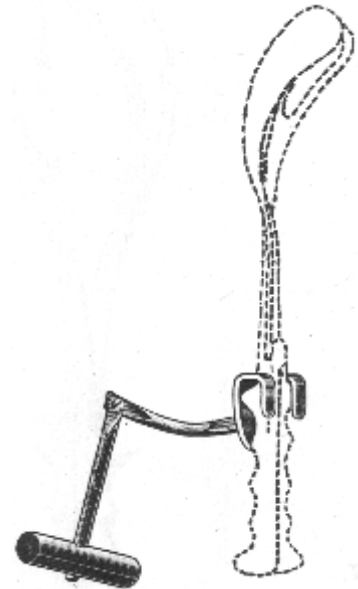

BILL  
NF.06.16.10

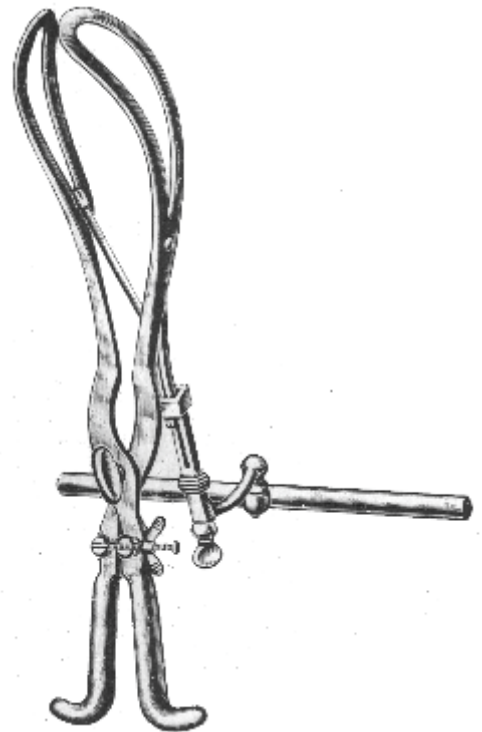

TARNIER  
NF.06.15.40  
40 cm/ 15 $\frac{3}{4}$ "



KIELLAND  
NF.06.17.40  
40 cm/ 15¾"



KIELLAND-LUIKART  
NF.06.18.40  
40 cm/ 15¾"



PIPER  
NF.06.19.44  
44 cm/ 17½"



**KIELLAND-LUIKART**  
NF.06.20.38  
38 cm / 15"



**BRAUN-STADLER**  
NF.06.20.15 15 cm / 6"  
NF.06.20.18 18 cm / 7 1/8"  
NF.06.20.21 21 cm / 8 1/4"  
NF.06.20.22 22 cm / 9"

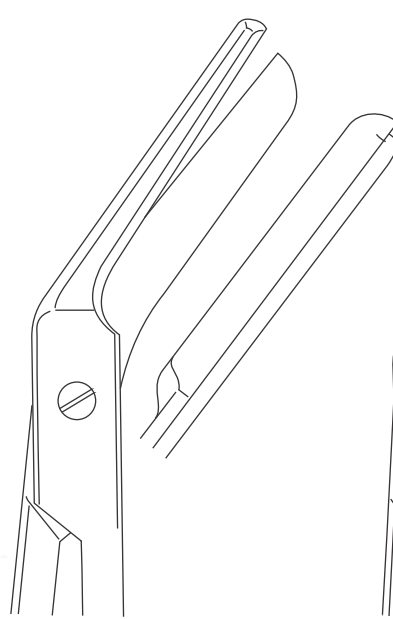

NF.06.20.15

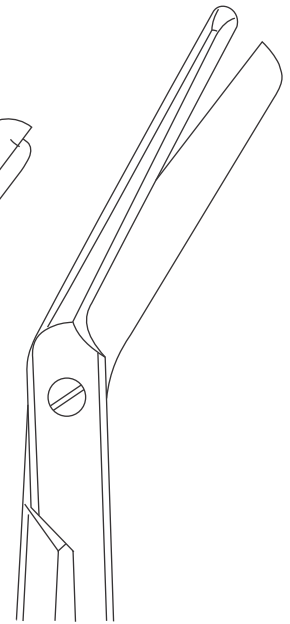

NF.06.20.21



**WALDMANN**  
18 cm / 7 1/8"  
NF.06.21.18  
Standard  
NF.06.21.118  
Supercut

# Obstetrics



SIMPSON  
NF.06.21.23  
23 cm/ 9"



WRIGLEY  
NF.06.22.28  
28 cm/ 11"



BOERMA  
NF.06.22.35  
28 cm/ 11"

Obstetrical spoon  
Geburtslöffel  
Cuchara obstétrica  
Cuiller obstétricale  
Cucchiaio ostetrico



NAEGELE  
NF.06.23.35 35 cm/ 13¾"  
NF.06.23.40 40 cm/ 15¾"

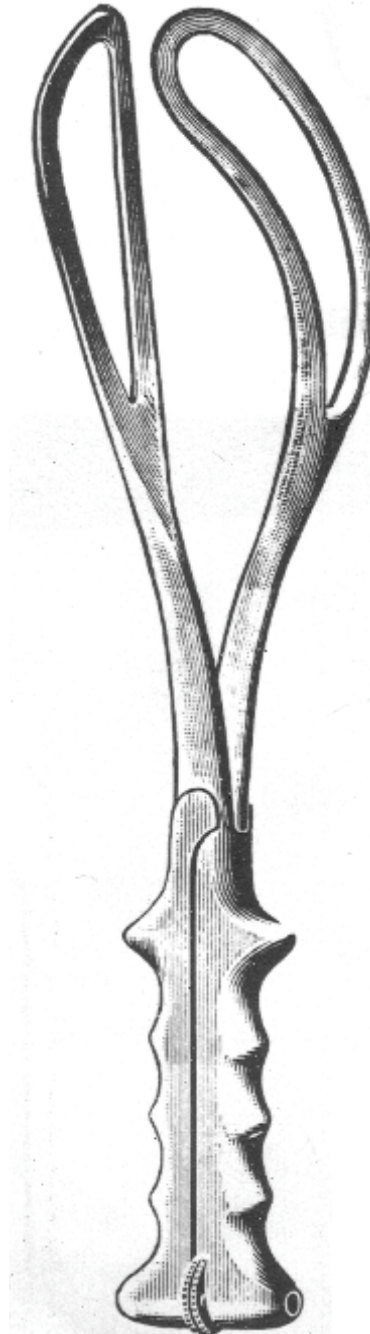

ELLIOT  
NF.06.24.32 32 cm/ 12½"  
NF.06.24.38 38 cm/ 15"



SELLHEIM  
NF.06.25.28  
28 cm/ 11"

# Obstetrics



SELLHEIM  
NF.06.25.30  
30 cm / 12"



SMELLIE  
NF.06.26.30  
30 cm / 11 1/4"

Decapitation Hook



BRAUN  
NF.06.27.31  
31 cm / 12"

Cranioclast



BRAUN  
NF.06.28.42  
42 cm / 16 1/2"

Perforator



SMELLIE  
NF.06.30.27  
27 cm / 10 3/4"  
Perforator



# Obstetrics



UMBILICAL  
NF.06.32.11  
10.5 cm / 4 1/4"

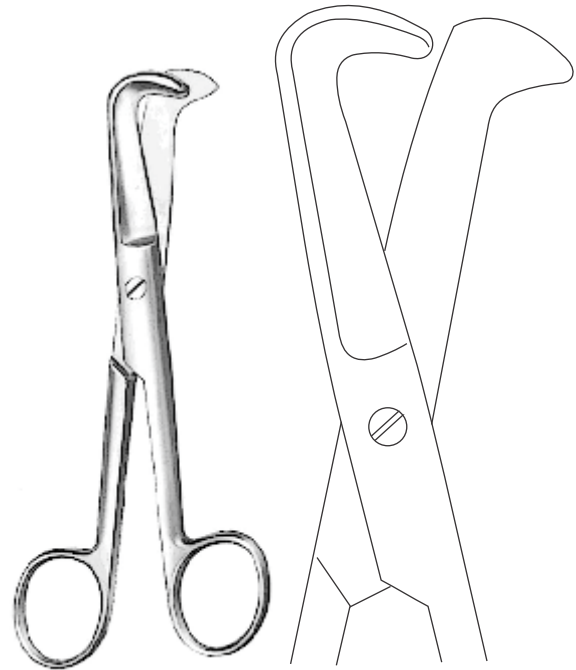

SCHUMACHER  
NF.06.33.16  
16 cm / 6 1/4"

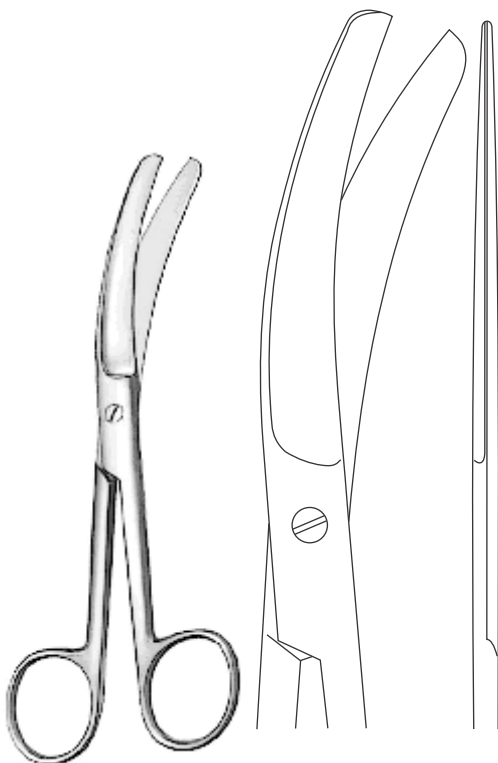

BUSCH  
NF.06.34.13 13 cm / 5 1/8"  
NF.06.34.16 16 cm / 6 1/4"  
NF.06.34.47 16 cm / 6 1/4" one serrated blade

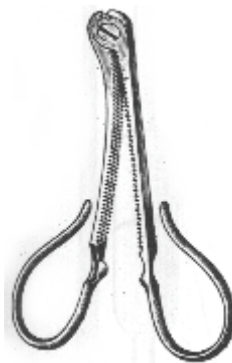

KANE  
NF.06.35.09  
8.5 cm / 3 1/4"



COLLIN  
NF.06.36.09  
8.5 cm / 3 1/4"

Umbilical cord clamp



LOVSET  
NF.06.38.25  
package/100 pieces

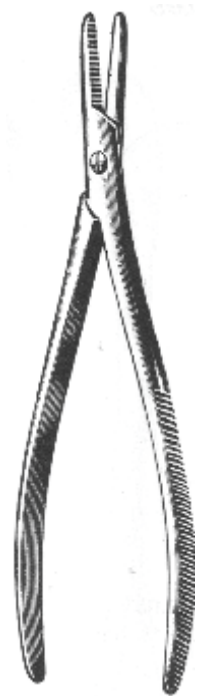

LOVSET  
NF.06.37.20  
20 cm / 7 1/4"

# Obstetrics



WINTER  
28 cm/ 11"

NF.06.39.01  
# 1 - 8 mm



NF.06.39.02  
# 2 - 10 mm



NF.06.39.03  
# 3 - 14 mm



WINTER  
28 cm/ 11"

NF.06.40.10  
# 1 - 8 mm



NF.06.40.12  
# 2 - 10 mm



NF.06.40.15  
# 3 - 14 mm

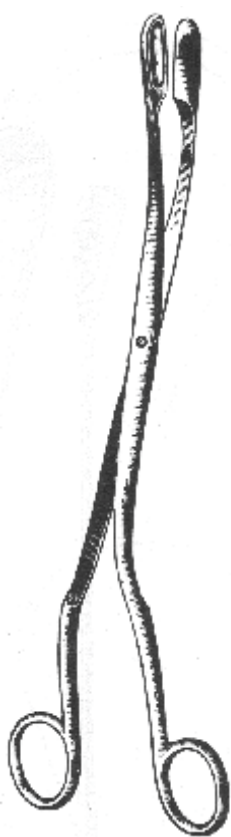
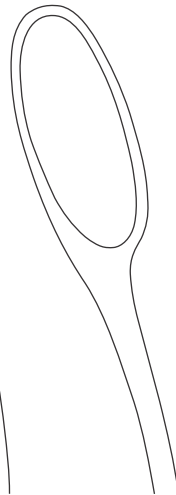

WINTER  
NF.06.41.27  
27 cm/ 10 1/4"  
14 mm

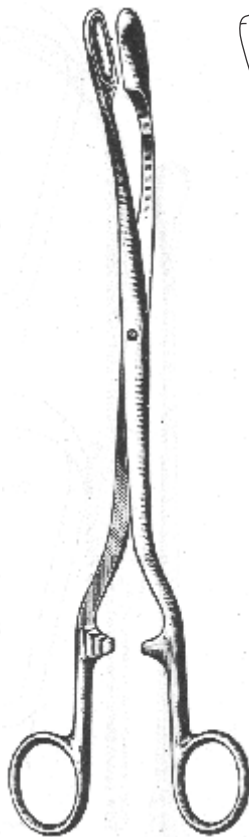

WINTER  
NF.06.42.32 #2-10 mm  
NF.06.42.33 #3-14 mm

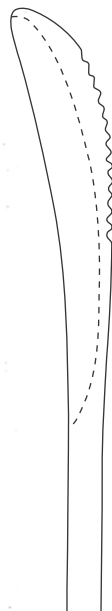

CUZZI  
30 cm/ 11 3/4"

NF.06.43.01  
# 1 - 14 mm



NF.06.43.02  
# 2 - 18 mm



NF.06.43.03  
# 3 - 21 mm

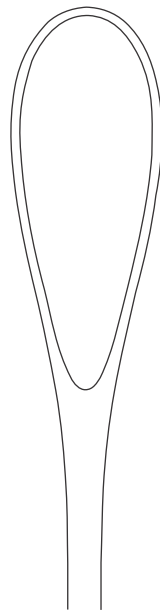

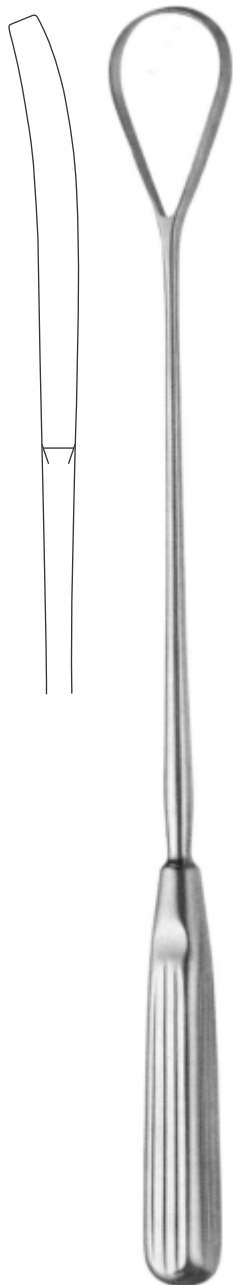

RECAMIER

NF.06.43.11  
sharp

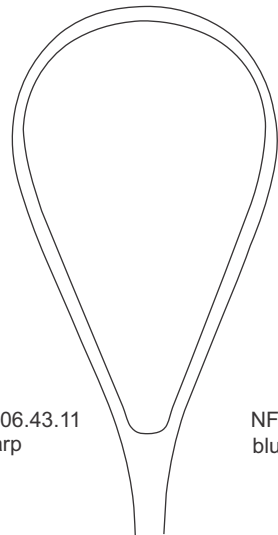

35 mm  
34 cm/13<sup>3</sup>/<sub>16</sub>"

NF.06.43.15  
blunt

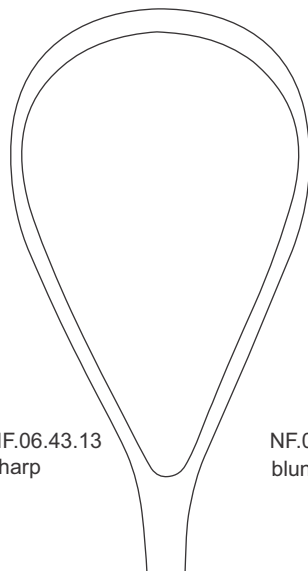

40 mm  
35 cm - 13<sup>3</sup>/<sub>4</sub>"

NF.06.43.13  
sharp

NF.06.43.17  
blunt

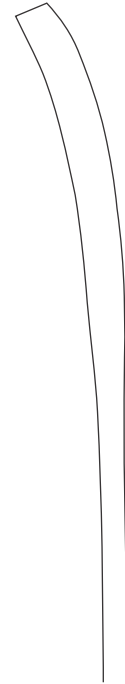

sharp



BUMM (RECAMIER)  
NF.06.43.24 24 mm  
NF.06.43.26 26 mm  
NF.06.43.28 28 mm  
30-31 cm

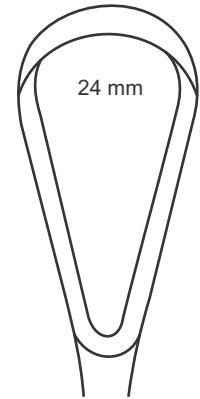

24 mm

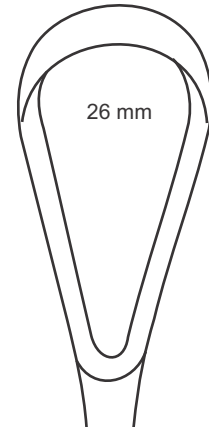

26 mm

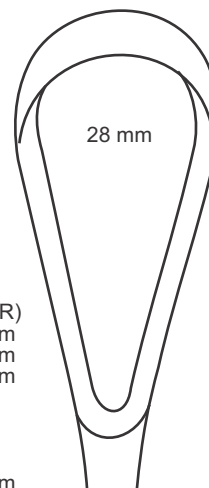

28 mm

blunt

NF.06.43.44 24 mm  
NF.06.43.46 26 mm  
NF.06.43.48 28 mm  
30-31 cm

# Obstetrics



**WALLICH**  
NF.06.44.42  
42 cm / 16½"

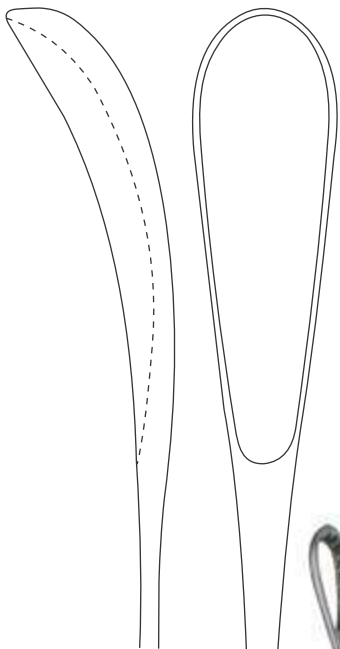

19 mm



**SAENGER**  
29 cm / 11¼"

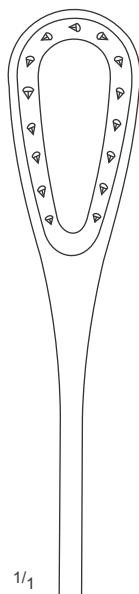

1/1

NF.06.45.28  
17 mm

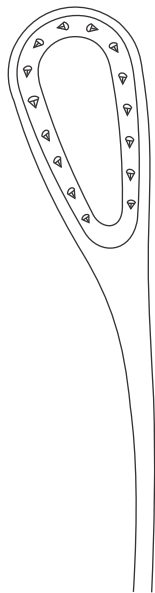

NF.06.45.29  
17 mm



**SAENGER**  
27 cm / 10¾"

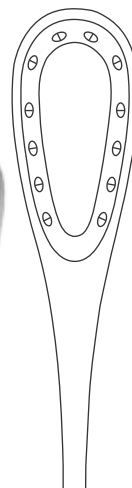

NF.06.46.27  
18 mm

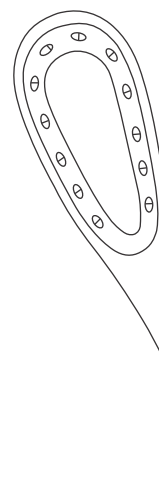

NF.06.47.27  
18 mm



**PESTALOZZA**  
NF.06.47.40  
30 cm/ 11¼"

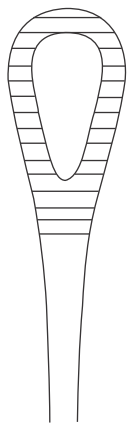

**MCCLINTOCK**  
NF.06.48.24  
24 cm/ 9½"

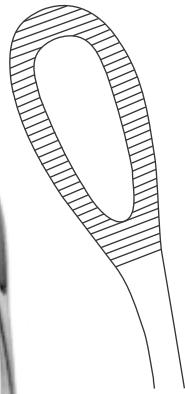

**LEWKOWITZ**  
NF.06.49.40  
24 cm/ 9½"

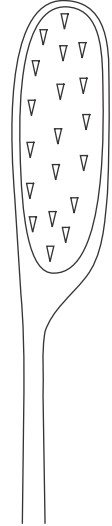

# Bandage and Plaster Cast Instruments



# Bandage and Plaster Cast Instruments



STILLE  
NF.06.01.23 23 cm/ 9"  
NF.06.01.26 26 cm/ 10¼"  
NF.06.01.37 37 cm/ 14½"

NF.06.01.73  
Spare Blade for NF.06.01.23

NF.06.01.77  
Spare Blade for NF.06.01.37

NF.06.01.76  
Spare Blade for NF.06.01.26



STILLE  
NF.06.02.37  
37 cm/ 14½"  
NF.06.02.77  
Spare Blade For NF.06.02.37

# Bandage and Plaster Cast Instruments



MOD.USA  
NF.06.03.23  
23 cm / 9"



WOLFF BOEHLER  
NF.06.04.18 18 cm / 7 1/8"  
NF.06.04.24 24 cm / 9 1/2"



HENNIG  
NF.06.05.27  
27 cm / 10 3/4"

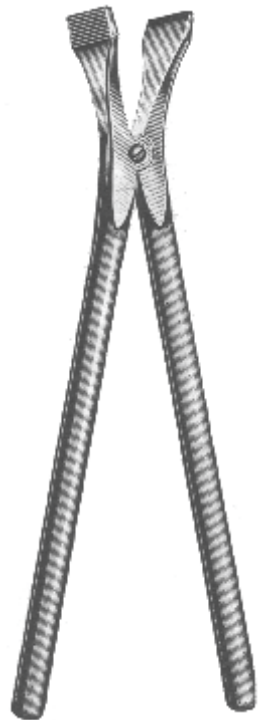

BEESON  
NF.06.06.30  
30 cm / 11 3/4"

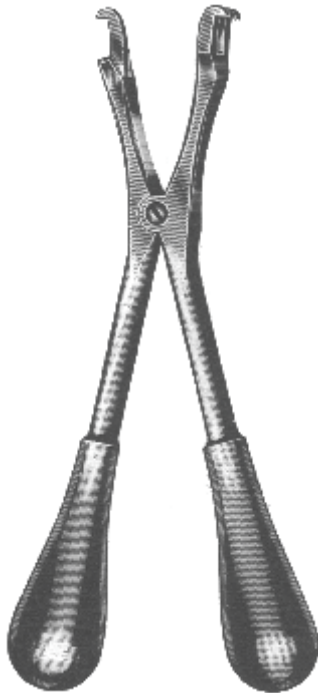

HAGLUND STILLE  
NF.06.07.28  
28 cm / 11"



WIGMORE  
NF.06.09.19  
19 cm / 7 1/2"

Plaster Saw



ENGEL  
NF.06.10.15  
15 cm / 6"



ESMARCH  
NF.06.11.18  
18 cm / 7 1/8"



# Bandage and Plaster Cast Instruments



SAUERBRUCH  
NF.06.08.55  
55 cm/ 21¾"



HOPKINS  
NF.06.12.20  
20 cm/ 8"



REINER  
NF.06.13.19  
19 cm/ 7½"



STILLE  
NF.06.18.23  
23 cm/ 9"



CARTILAGE  
NF.06.16.21  
21 cm/ 8¼"

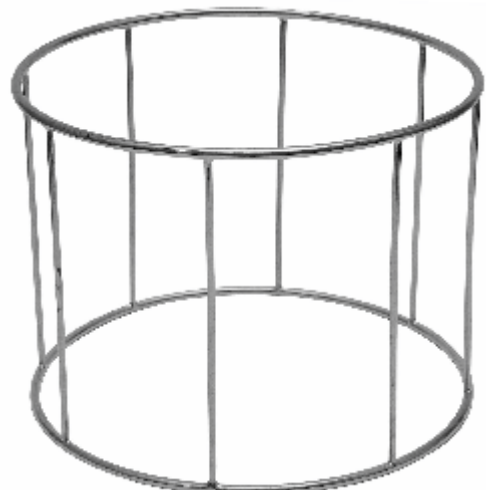
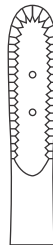

TUBE GAUZE  
NF.06.15.01 Size "A"  
NF.06.15.13 Size "C" 154.00 mm x 36.30 mm  
NF.06.15.14 Size "D" 154.00 mm x 36.30 mm  
NF.06.15.15 Size "E" 154.00 mm x 51.80 mm  
NF.06.15.16 Size "F" 154.00 mm x 130.00 mm  
NF.06.15.27 Size "G" 154.00 mm x 180.00 mm  
NF.06.15.28 Size "H" 154.00 mm x 205.00 mm  
NF.06.15.19 Size "J" 154.00 mm x 233.00 mm  
NF.06.15.26 Size "FX" 154.00 mm x 156.00 mm  
NF.06.15.29 Size "K" 153.00 mm x 252.00 mm

# Bandage and Plaster Cast Instruments



**BANDAGE**  
NF.06.17.22  
23 cm/ 9"

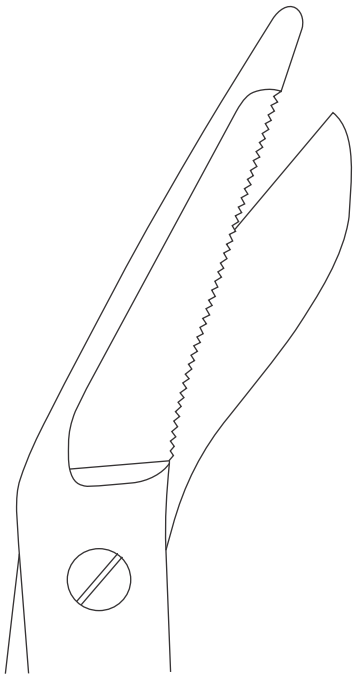

**STILLE MINI**  
NF.06.19.20  
20 cm/ 8"

# Sterilization

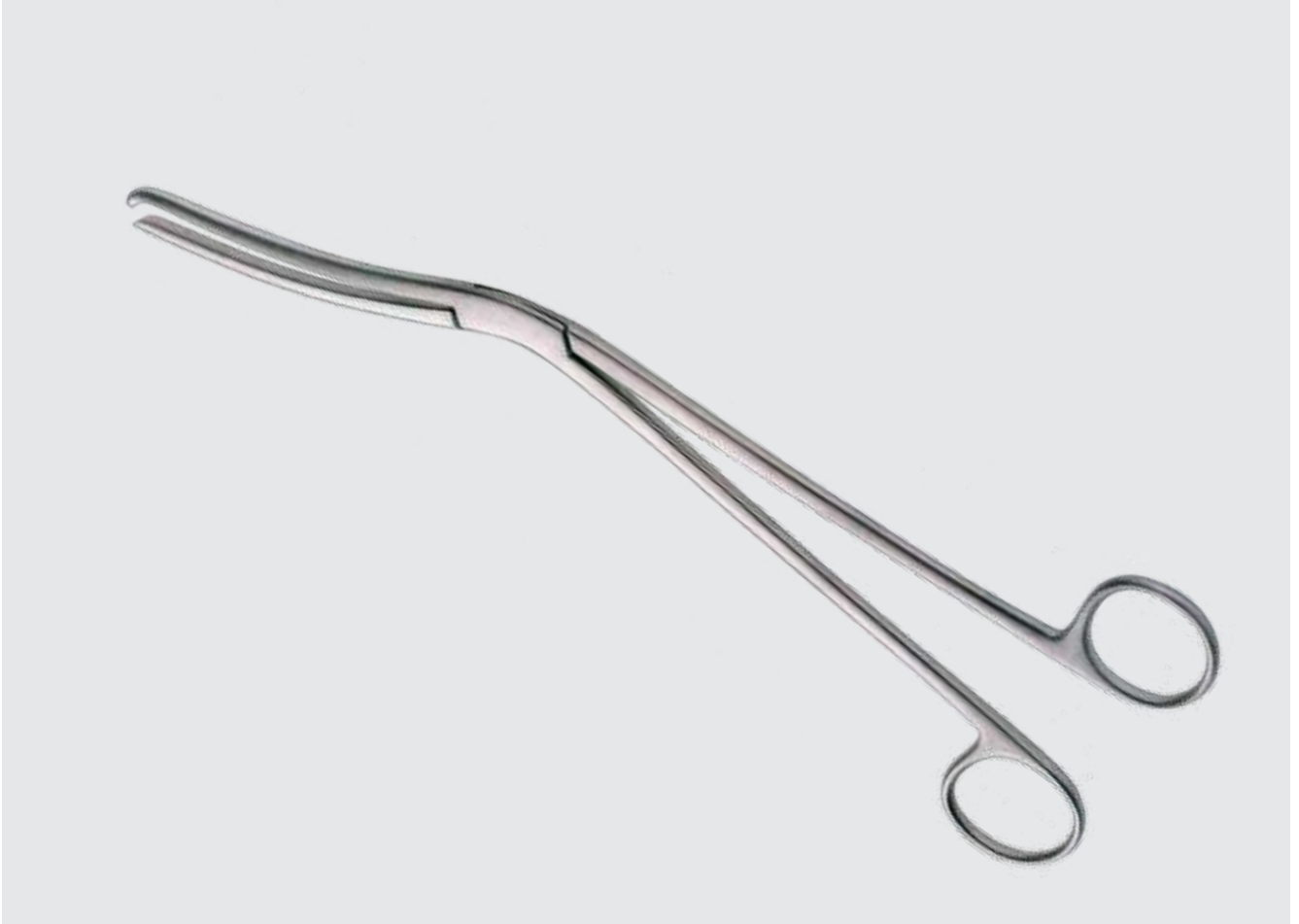

# Sterilization

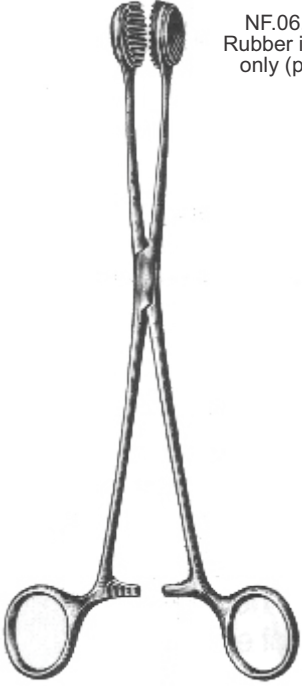

NF.06.01.26  
Rubber inserts  
only (pairs)

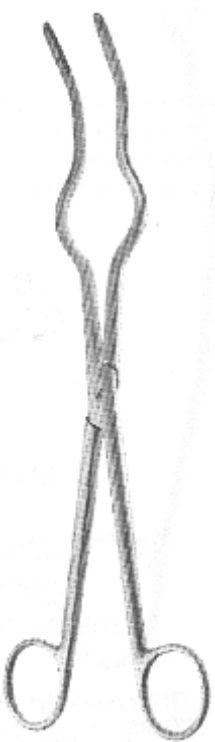

ULLEVAL  
NF.06.02.24  
24 cm/ 9½"



CHEATTLE  
NF.06.03.27  
27 cm/ 10¾"

NF.06.01.24  
24 cm/ 9½"



NF.06.04.20 20 cm/ 8"  
NF.06.04.28 28 cm/ 11"

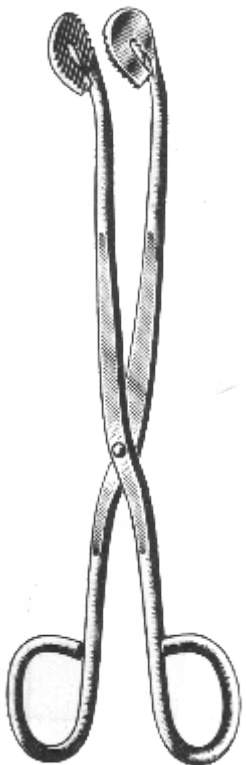

NF.06.05.20 20 cm/ 8"  
NF.06.05.28 28 cm/ 11"



HAKIE  
NF.06.08.25  
for ring handle instruments (without instruments)

# Sterilization



BUNT (MAYO)  
NF.06.10.13  
14 cm/ 5½"



BUNT (MAYO)  
NF.06.10.12  
12 cm/ 4¾"

BUNT (MAYO)  
NF.06.10.14  
14 cm/ 5½"



Supplied without wires

- |                            |                  |
|----------------------------|------------------|
|                            | for wires up to: |
| NF.06.10.23<br>16 cm/ 6¼"  | 15 cm/ 6"        |
| NF.06.10.24<br>19 cm/ 7½"  | 18 cm/ 7⅞"       |
| NF.06.10.25<br>32 cm/ 12½" | 31 cm/ 12"       |
| KIRSCHNER<br>Ø 12 mm       |                  |



Needle case  
NF.06.19.65  
Ø 65 mm x 15 mm

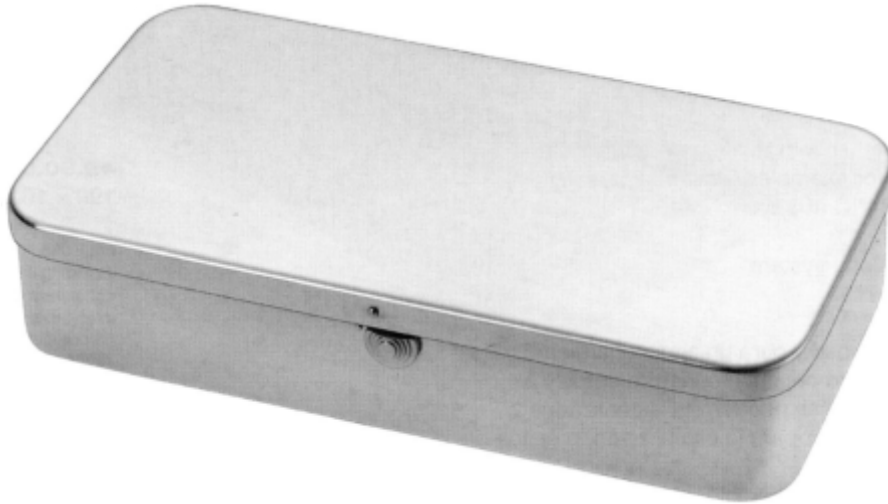

- NF.06.22.20 200 x 100 x 20 mm
  - NF.06.22.30 200 x 100 x 30 mm
  - NF.06.22.40 200 x 100 x 40 mm
  - NF.06.22.50 200 x 100 x 50 mm
- Metal cases, empty with lid and slide lock



Horizontal ventilation

## SCHIMMELBUSCH

NF.06.25.14	14 x 14 cm
NF.06.25.16	16 x 15 cm
NF.06.25.19	19 x 16 cm
NF.06.25.20	19 x 19 cm
NF.06.25.24	24 x 12 cm
NF.06.25.25	24 x 16 cm
NF.06.25.27	24 x 24 cm
NF.06.25.29	29 x 16 cm
NF.06.25.30	29 x 24 cm
NF.06.25.34	34 x 16 cm
NF.06.25.35	34 x 24 cm
NF.06.25.39	39 x 14 cm
NF.06.25.40	39 x 19 cm
NF.06.25.41	39 x 29 cm



Vertical ventilation

## KONRICH

	ø	h
NF.06.26.14	14	14 cm
NF.06.26.16	16	15 cm
NF.06.26.19	19	16 cm
NF.06.26.20	19	19 cm
NF.06.26.24	24	12 cm
NF.06.26.25	24	16 cm
NF.06.26.27	24	24 cm
NF.06.26.29	29	16 cm
NF.06.26.30	29	24 cm
NF.06.26.34	34	16 cm
NF.06.26.35	34	24 cm
NF.06.26.36	35	30 cm
NF.06.26.39	39	14 cm
NF.06.26.40	39	19 cm
NF.06.26.41	39	29 cm
NF.06.26.45	39	35 cm

# Suture



# Suture

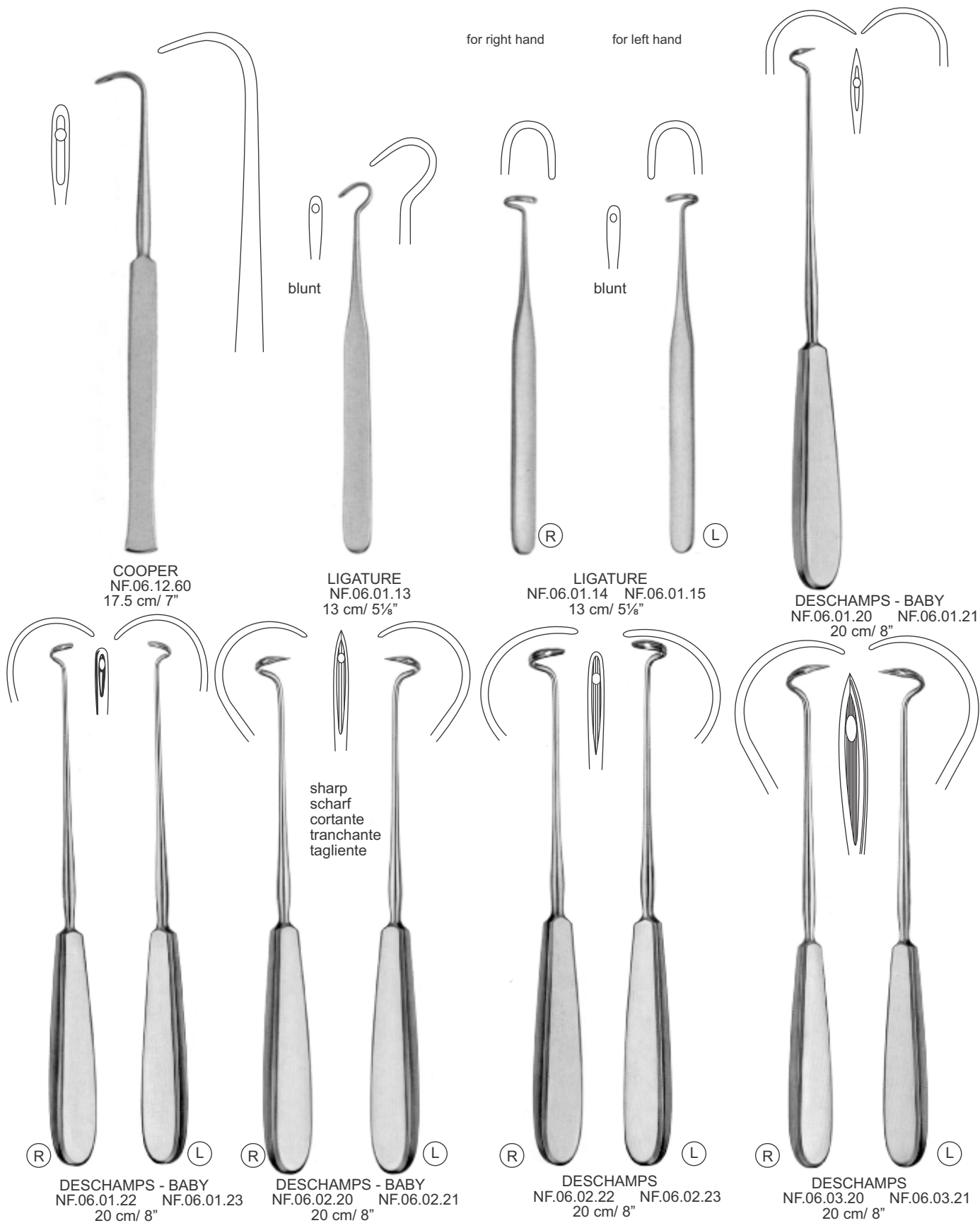



# Suture

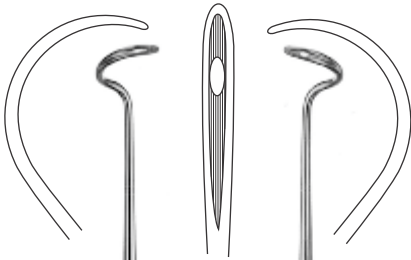

(R)

DESCHAMPS  
NF.06.03.22 NF.06.03.23  
20 cm/ 8"

(L)

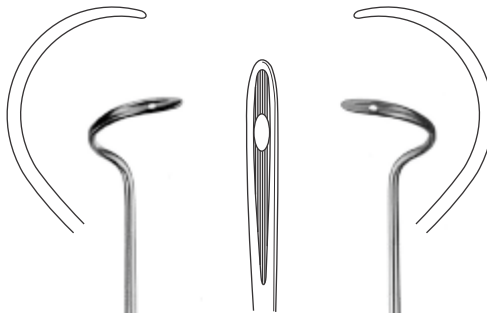

(R)

DESCHAMPS  
NF.06.04.28 NF.06.04.29  
30 cm/11¾"

(L)

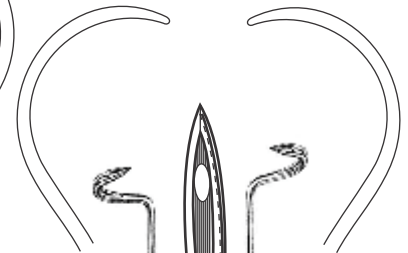

(R)

DESCHAMPS  
NF.06.05.28 NF.06.05.29  
28 cm/11"

(L)

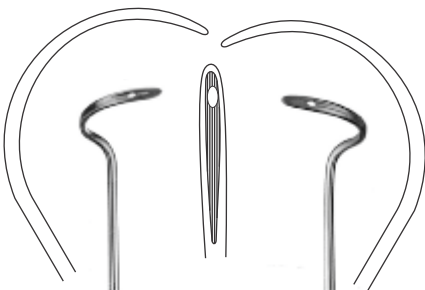

(R)

DESCHAMPS  
NF.06.03.24 NF.06.03.25  
24 cm/ 9½"

(L)

# Suture



Knot tier

**BOZEMANN**  
NF.06.08.61  
21.5 cm/ 8½"



Ligature adjuster

NF.06.08.63  
23 cm/ 9"



Ligature catcher

**MOD. WIEN**  
NF.06.08.64  
23.5 cm/ 9¼"



**LANGE**  
NF.06.09.10  
10 cm/ 4"



**MICHEL**  
NF.06.10.12  
12.5 cm/ 5"

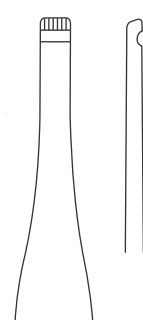

**CHILD**  
NF.06.11.17  
17 cm/ 6¾"

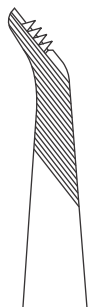

**HEGENBARTH**  
NF.06.13.12  
12 cm/ 4¾"



**WACHENFELDT**  
NF.06.14.12  
12 cm/ 4¾"



**WACHENFELDT**  
NF.06.15.12  
12 cm/ 4¾"



12.5 cm/ 5"



**MICHEL**  
NF.06.16.12

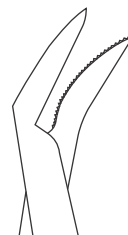

**MICHEL MODIF.**  
NF.06.16.13

# Suture



**COLLIN**  
NF.06.17.13  
13 cm / 5 $\frac{1}{8}$ "



**HEATH**  
NF.06.18.14  
13 cm / 5 $\frac{1}{8}$ "



**SPENCER**  
NF.06.19.09  
9 cm / 3 $\frac{1}{2}$ "



**SPENCER**  
NF.06.20.10 – 10.5 cm / 4 $\frac{1}{8}$ "  
NF.06.20.12 – 12 cm / 4 $\frac{3}{4}$ "  
NF.06.20.14 – 14 cm / 5 $\frac{1}{2}$ "

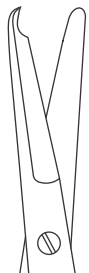

**"TC"**  
NF.06.20.60  
10.5 cm / 4 $\frac{1}{8}$ "

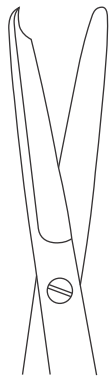

**"TC"**  
NF.06.20.62  
12 cm / 4 $\frac{3}{4}$ "

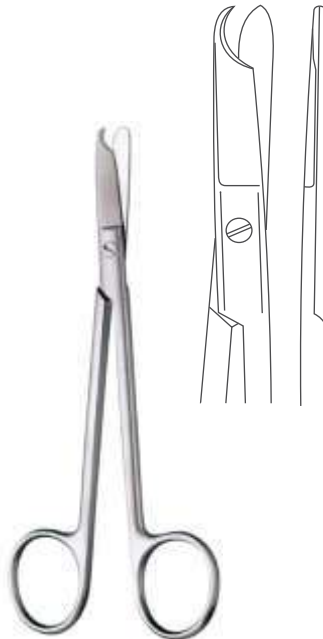

**LITTAUER**  
NF.06.21.13  
13 cm / 5 $\frac{1}{8}$ "

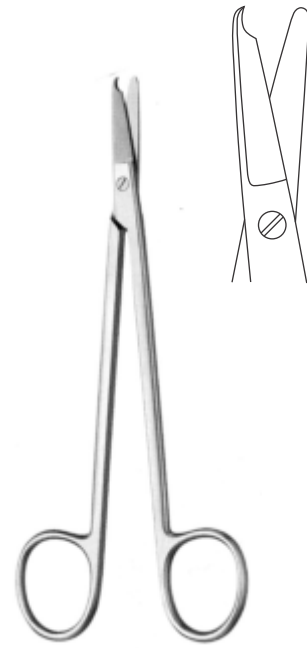

**KELLY**  
NF.06.21.35  
15 cm / 6"



**SPENCER**

# Suture

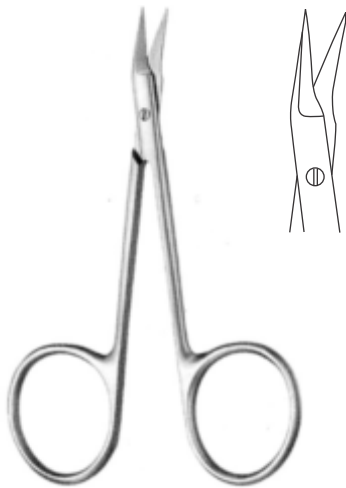

O'BRIEN  
NF.06.22.09  
9 cm / 3½"

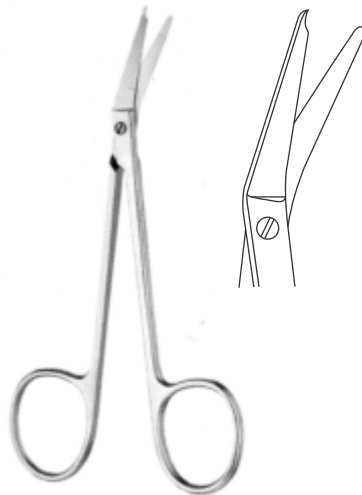

SPENCER  
NF.06.22.11  
11.5 cm / 4½"

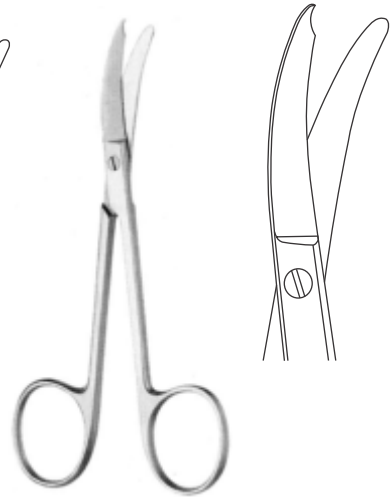

SPENCER  
NF.06.22.12  
12 cm / 4¾"

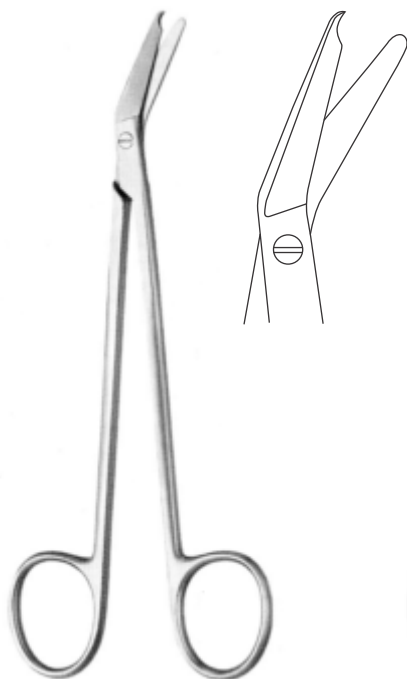

LOCKLIN  
NF.06.22.15  
15 cm / 6"



EISELSBERG  
NF.06.22.91  
11 cm / 4 3/8"



NF.06.23.84  
14.5 cm / 4¾"

# Suture

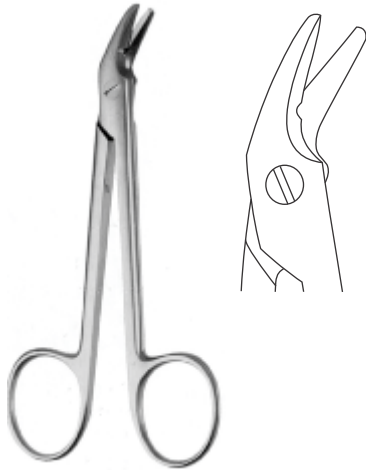

UNIVERSAL  
NF.06.23.12  
12 cm/ 4¾"

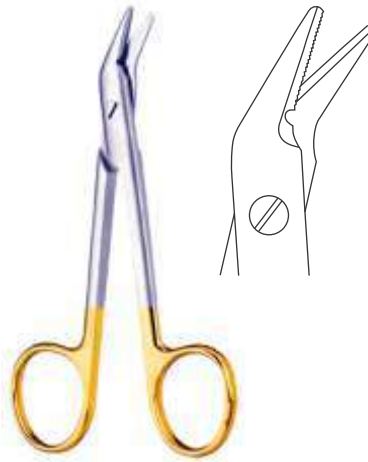

UNIVERSAL "TC"  
NF.06.24.12  
12 cm/ 4¾"



UNIVERSAL "TC"  
NF.06.24.16  
16 cm/ 6¼"

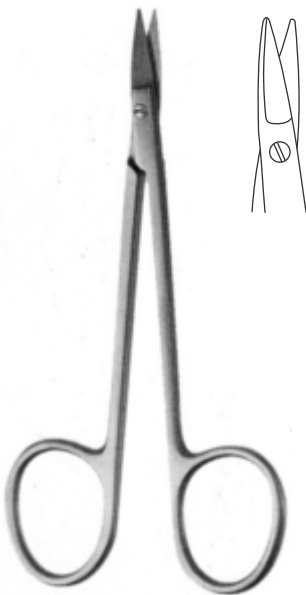

SCHUKNECHT  
NF.06.25.09  
10 cm/ 4"

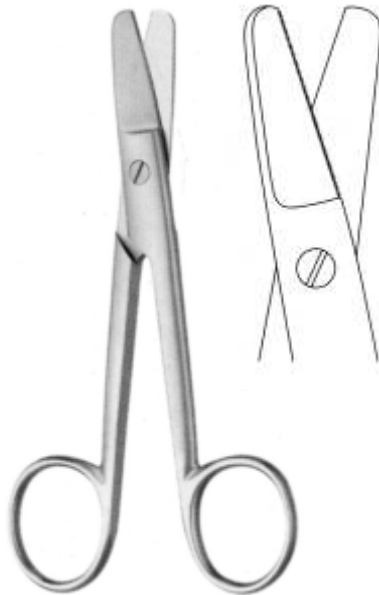

HARVEY  
NF.06.25.10  
13 cm/ 5⅛"

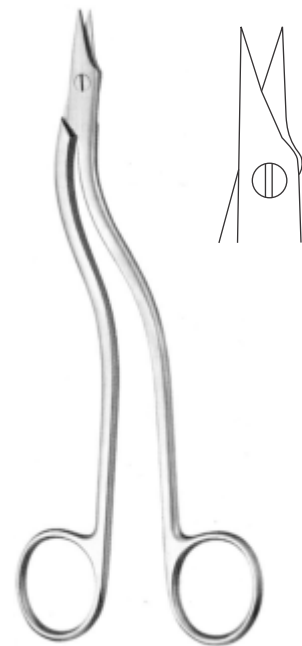

HEATH  
NF.06.25.15  
15 cm/ 6"  
NF.06.25.18  
18 cm/ 7⅛"

# Suture



**BEEBEE**  
10.5cm/ 4 1/4"

serrated



NF.06.26.10



NF.06.26.20



NF.06.28.10



NF.06.28.20



NF.06.27.10

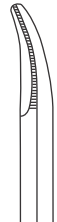

NF.06.27.20



NF.06.29.10



NF.06.29.20



**BEEBEE**  
12.5 cm -5"



NF.06.26.12



NF.06.26.22



NF.06.28.12



NF.06.28.22



NF.06.27.12

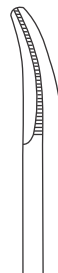

NF.06.27.22



NF.06.29.12

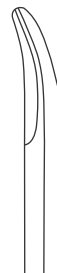

NF.06.29.22

# Suture



NF.06.30.12  
12 cm - 4¾"

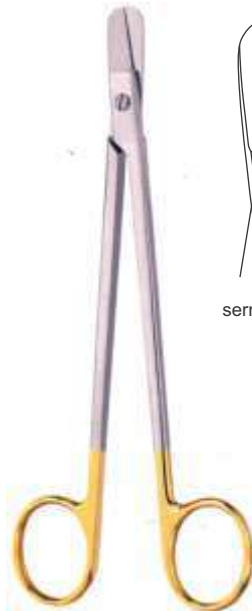

serrated blade

NF.06.30.36  
16 cm - 6¼"  
"TC"



NF.06.30.37  
16 cm - 6¼"  
"TC"



"TC"

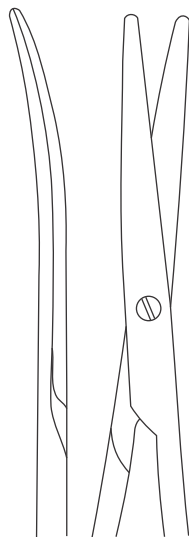

NF.06.36.84  
14.5 cm - 5¾"



NF.06.36.88  
18 cm - 7¼"

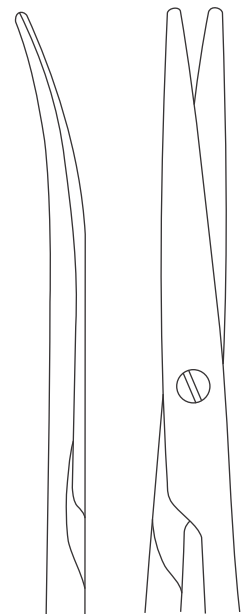

NF.06.36.93  
23 cm - 9"

Ligature scissors with micro serration and tungsten carbide edges

# Bone Files, Elevators, Raspatories





# Bone Files, Elevators, Raspatories

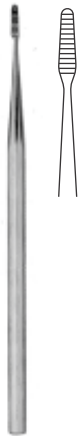

**BLACK**  
NF.06.01.11  
11 cm/ 4¼"  
NF.06.01.16  
16 cm/ 6¼"

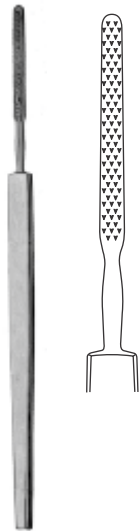

**JOSEPH**  
NF.06.02.13  
14 cm/ 5½"



**JOSEPH**  
17 cm/ 6¾"

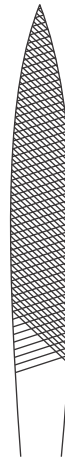

NF.06.03.01  
#1

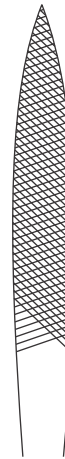

NF.06.03.02  
#2

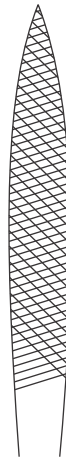

NF.06.03.03  
#3



**PUTTI**  
NF.06.04.28  
27 cm/ 10¾"



**PUTTI**  
NF.06.05.30  
30 cm/ 11¾"



NF.06.06.22  
22 cm/ 8¾"



NF.06.07.28  
28 cm/ 11"



NF.06.08.24  
24 cm/ 9½"

# Bone Files, Elevators, Raspatories

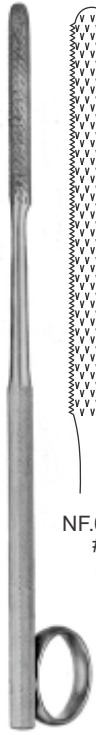

**GALLAHER**  
19 cm / 7½"

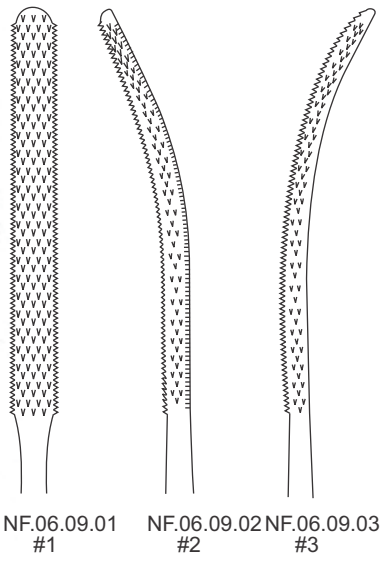

NF.06.09.01 #1    NF.06.09.02 #2    NF.06.09.03 #3



**MILLER**  
18 cm / 7⅞"

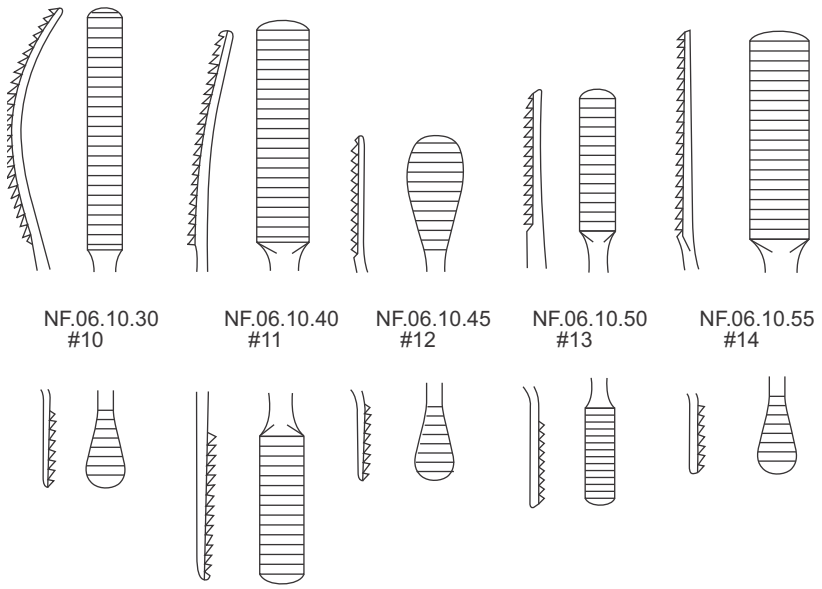

NF.06.10.30 #10    NF.06.10.40 #11    NF.06.10.45 #12    NF.06.10.50 #13    NF.06.10.55 #14



**MILLER**  
18 cm / 7⅞"

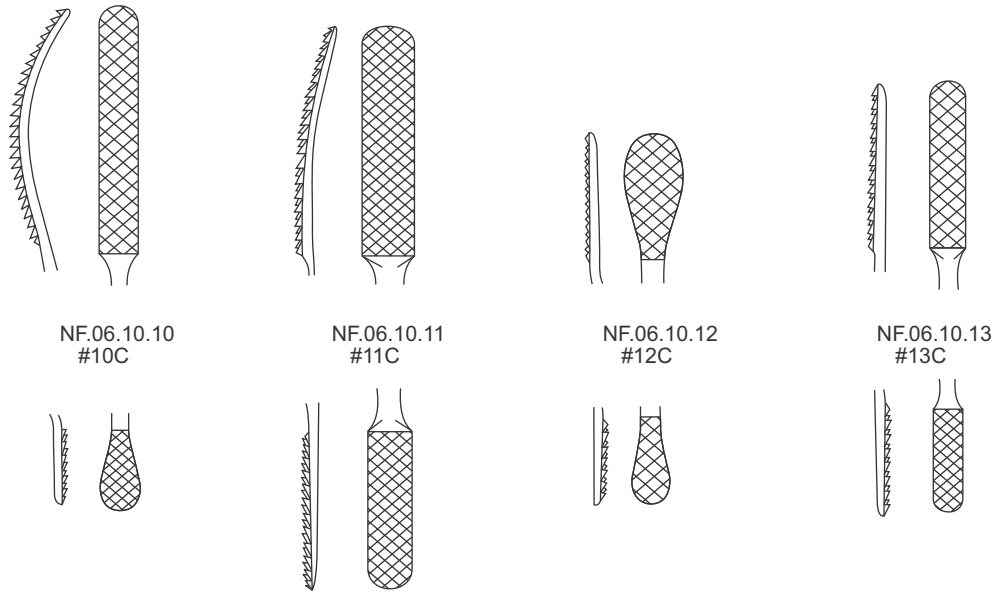

NF.06.10.10 #10C    NF.06.10.11 #11C    NF.06.10.12 #12C    NF.06.10.13 #13C

# Bone Files, Elevators, Raspatories

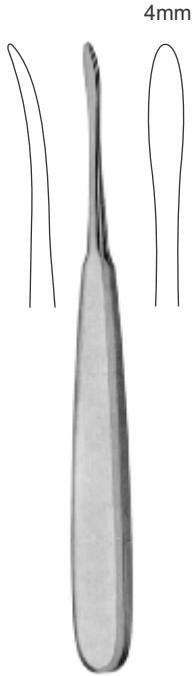

**SEBILEAU**  
NF.06.11.16  
16.5 cm/ 6½"

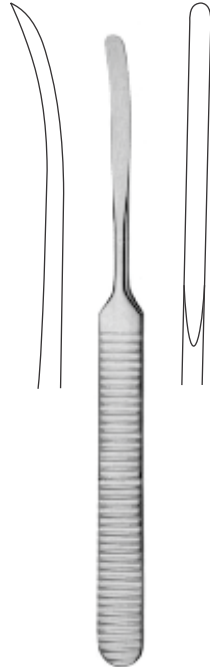

**WILLIGER**  
NF.06.11.17  
17 cm/ 6¾"

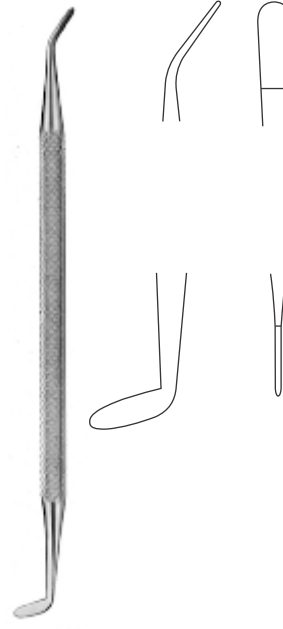

**NAGATA**  
NF.06.11.26  
16 cm/ 6¼"

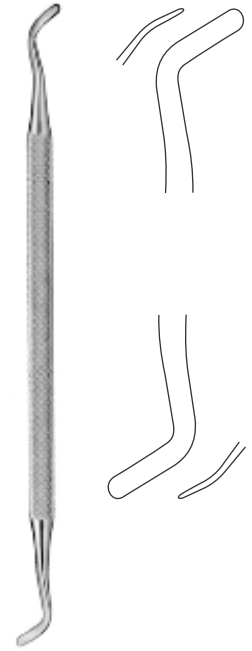

**NAGATA**  
NF.06.11.27  
17 cm/ 6¾"



**WILLIGER**  
16 cm/ 6¼"



NF.06.12.04

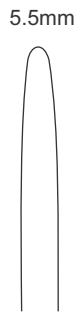

NF.06.12.06



NF.06.12.07



**LANGENBECK**

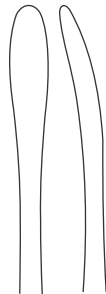

NF.06.13.01  
17 cm/ 6¾"  
5 mm



NF.06.13.02  
17 cm/ 6¾"  
7 mm



NF.06.13.03  
20 cm/ 8"  
8 mm

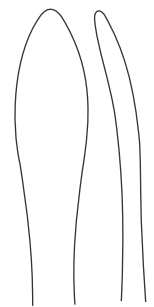

NF.06.13.04  
20 cm/ 8"  
10 mm

# Bone Files, Elevators, Raspatories



**HENAHAN**  
17 cm/ 6¾"



NF.06.13.10  
10 mm



NF.06.13.12  
12 mm



NF.06.13.15  
15 mm

semi sharp



**HOEN**

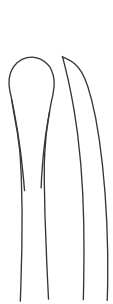

NF.06.14.07  
19 cm/ 7½"  
7 mm



NF.06.14.15  
19 cm/ 7½"  
15 mm

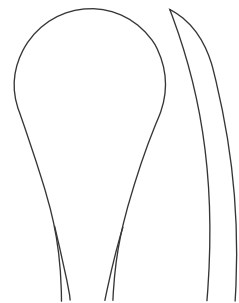

NF.06.14.20  
19 cm/ 7½"  
20 mm

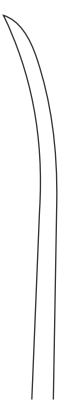

**WILLIGER**  
16 cm/ 6¼"

4mm

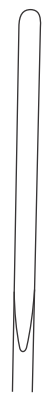

5mm



7mm



NF.06.15.03 NF.06.15.05 NF.06.15.07



**FREER**  
19 cm/ 7½"

5mm

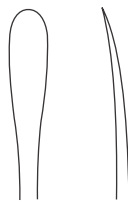

sharp/sharp

5mm



sharp/blunt

6.5mm



sharp/blunt



NF.06.18.01

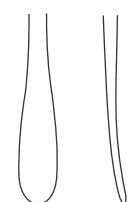

NF.06.18.02



NF.06.18.03

# Bone Files, Elevators, Raspatories

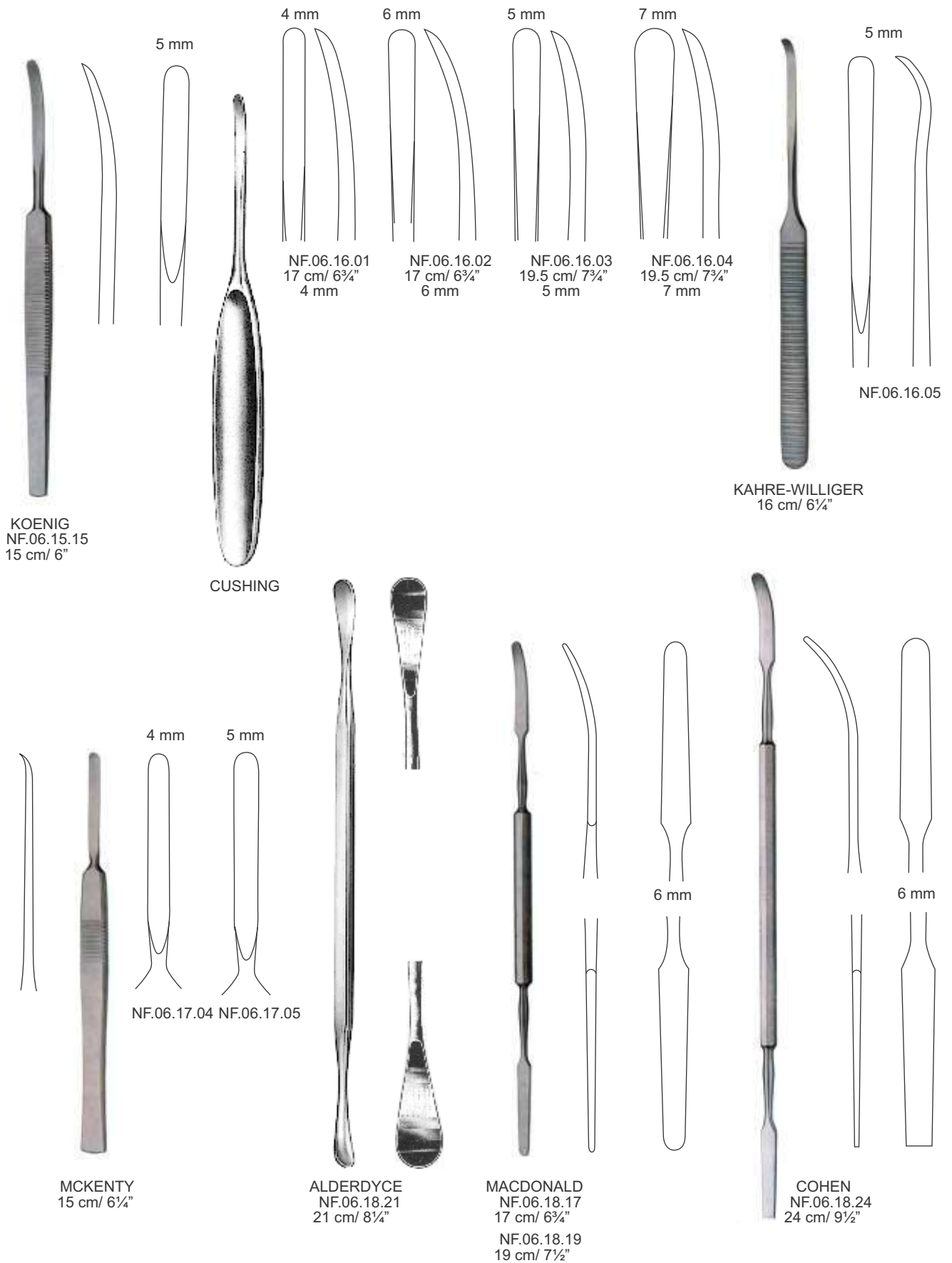

# Bone Files, Elevators, Raspatories

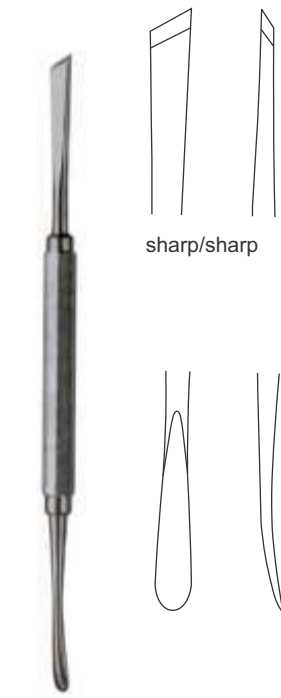

**MEAD**  
NF.06.19.16  
16.5 cm / 6½"

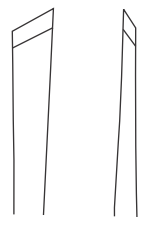

sharp/sharp



sharp/blunt



**MOLT**  
18 cm / 7½"

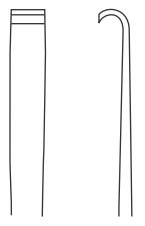

sharp/blunt

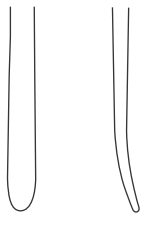

NF.06.19.18

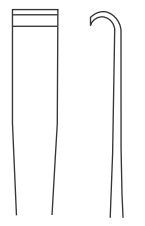

sharp/blunt



NF.06.19.19



sharp/blunt

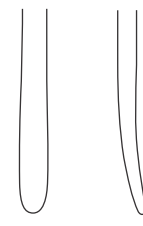

NF.06.19.20



sharp/sharp



NF.06.19.21

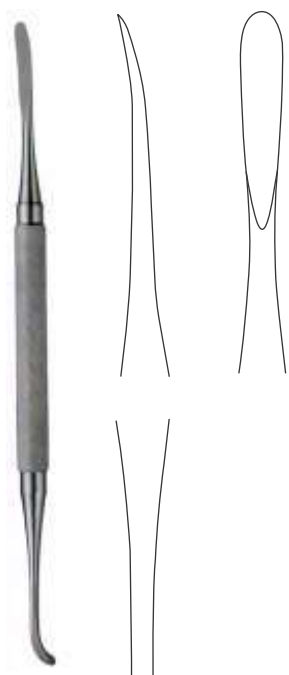

**BENNET**  
NF.06.18.27  
17 cm / 6¾"  
# 12S

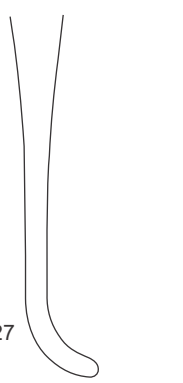
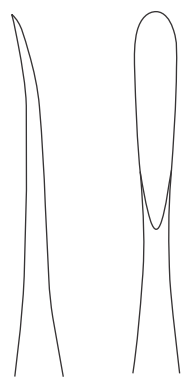

17 cm / 6¾"

6 mm

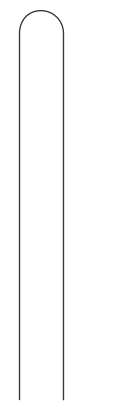

NF.06.20.06

8 mm



NF.06.20.08



**WARD**  
NF.06.21.19  
16.5 cm / 6½"

4 mm

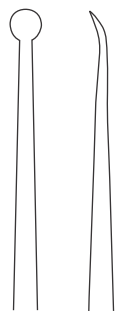

**JOSEPH**  
NF.06.22.16  
16.5 cm / 6½"

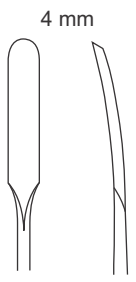

4 mm

# Bone Files, Elevators, Raspatories



**LEMPERT**  
17 cm / 6¾"

2 mm



NF.06.23.02

3 mm

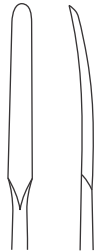

NF.06.23.03

4 mm

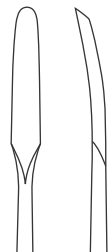

NF.06.23.04

5 mm



NF.06.23.05

3.5 mm

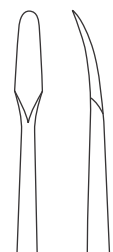

NF.06.23.06



**WIBERG**  
17 cm / 6¾"

4 mm



NF.06.24.01  
# 1

7 mm



NF.06.24.02  
# 2

9 mm



NF.06.24.03  
# 3

12 mm



NF.06.24.04  
# 4



**KRAEMER**  
NF.06.24.18  
18.5 cm / 7¼"

10 mm



**KRAEMER**  
NF.06.24.19  
19 cm / 7½"

10 mm

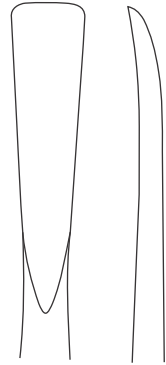

# Bone Files, Elevators, Raspatories

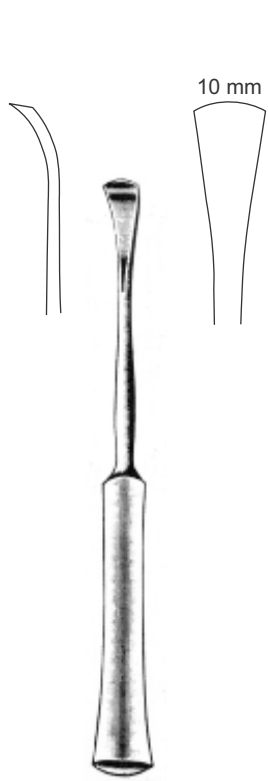

**HYLIN**  
NF.06.25.14  
14.5 cm / 5¾"

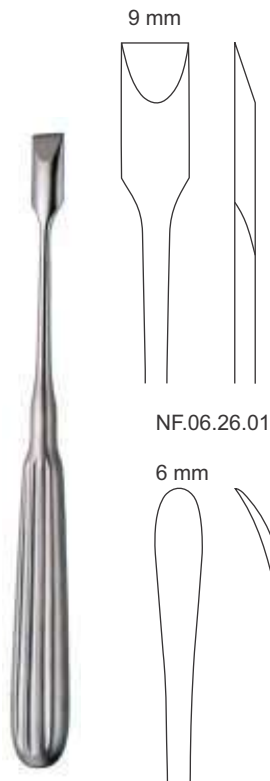

**ADSON**  
17 cm / 6¾"

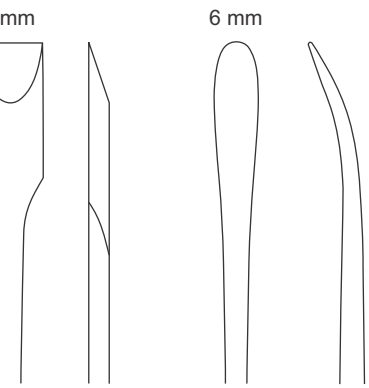

NF.06.26.01

NF.06.26.02

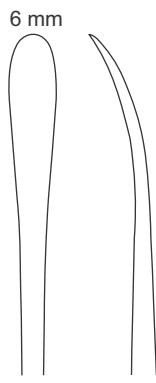

NF.06.26.03

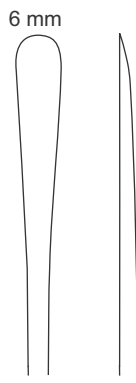

NF.06.26.04



**SEDILLOT**  
NF.06.28.21  
21 cm / 8¼"

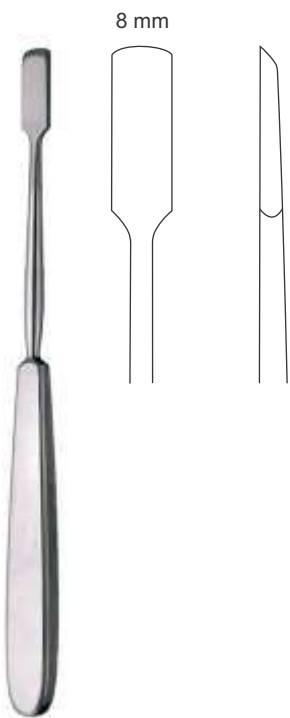

**OLIVECRONA**  
NF.06.25.18  
18 cm / 7½"

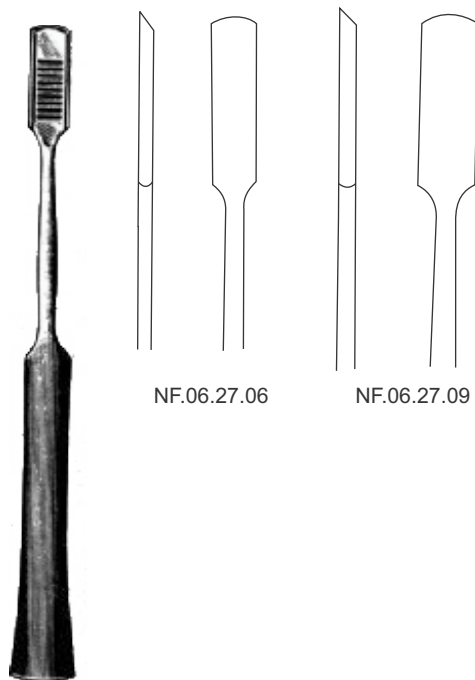

**MATHIEU**  
14 cm / 5½"

NF.06.27.06

NF.06.27.09

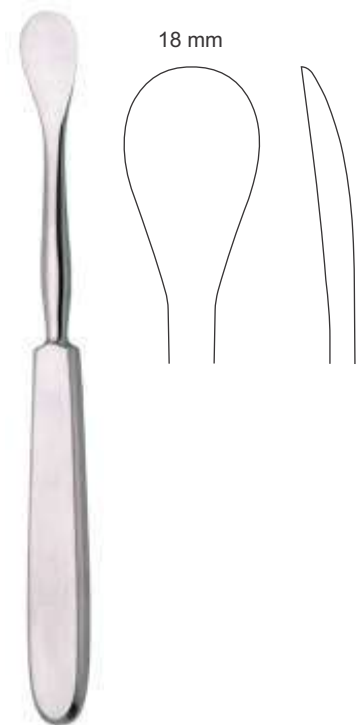

**SEDILLOT**  
NF.06.28.19  
19 cm / 7½"



# Bone Files, Elevators, Raspatories

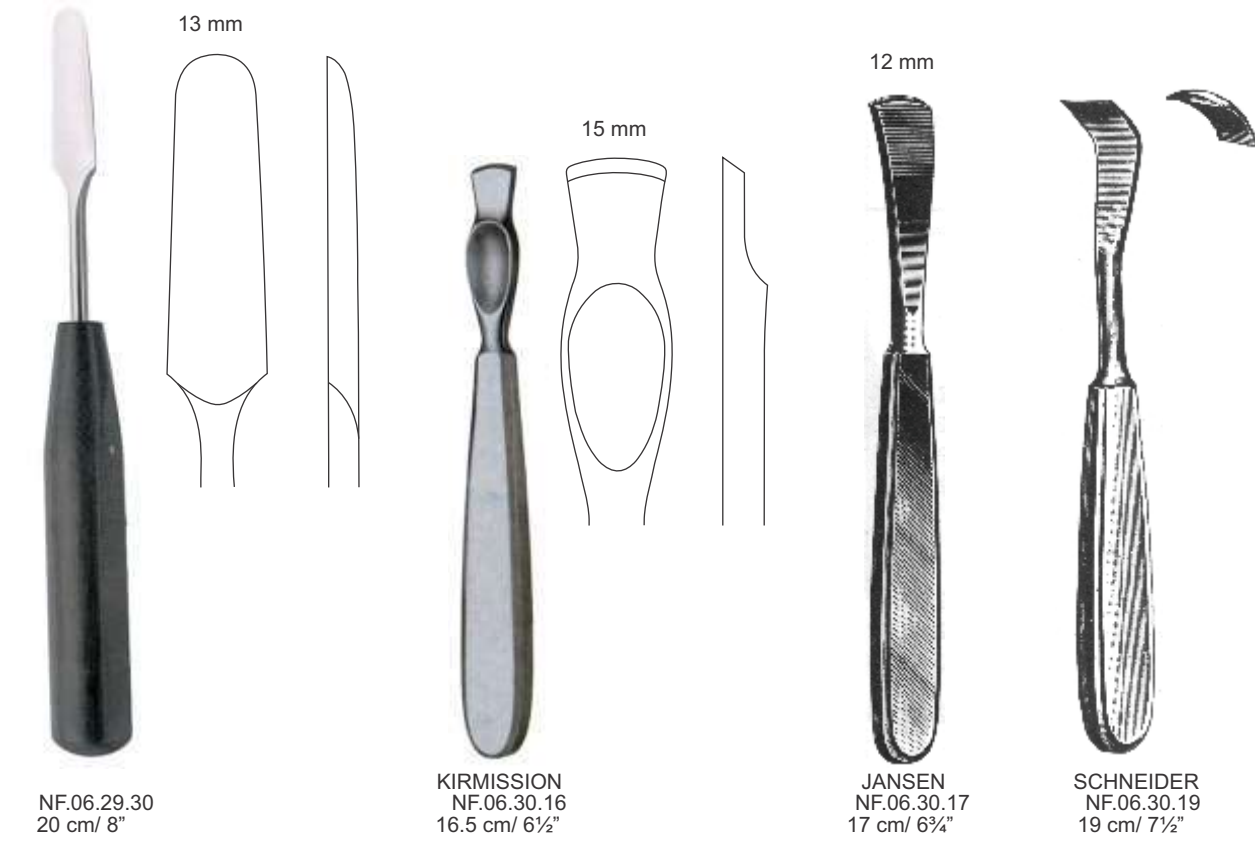

# Bone Files, Elevators, Raspatories



16 mm

18 mm

NF.06.30.36

NF.06.30.38

30 cm / 11¾"

SEMB  
NF.06.31.01  
20.5 cm / 8½"

SEMB  
NF.06.31.02  
24 cm / 9½"

SEMB  
NF.06.31.03  
24 cm / 9½"

SEMB  
NF.06.31.04  
22 cm / 8¾"

# Bone Files, Elevators, Raspatories



**SEMB**  
NF.07.31.07  
22.5 cm / 9"

12 mm

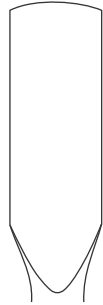

**FARABEUF**  
15 cm / 6"

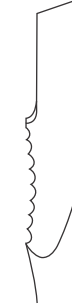

NF.07.32.15

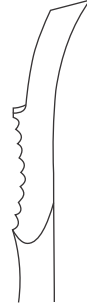

NF.07.32.16



**FARABEUF**  
NF.07.32.19  
19 cm / 7½"

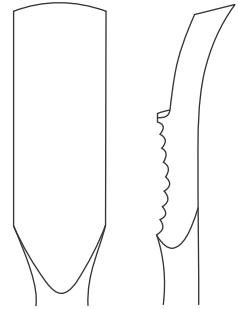

12 mm

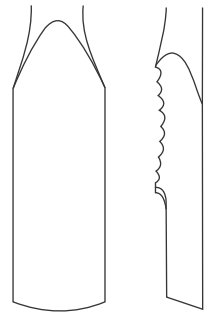

11 mm



**FARABEUF-COLLIN**  
16 cm / 6¼"

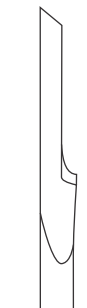

NF.07.32.46



NF.07.32.47



**NF.07.33.20**  
20 cm / 8"



13 mm



**NF.07.33.21**  
20 cm / 8"



14 mm



# Bone Files, Elevators, Raspatories



NF.07.33.22  
20 cm / 8"



LAMBOTTE  
22cm/8¾"

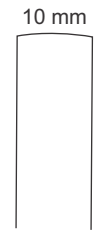

NF.07.34.10

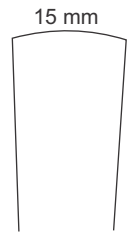

NF.07.34.15

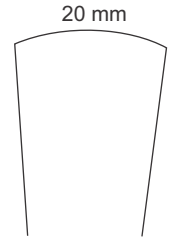

NF.07.34.20

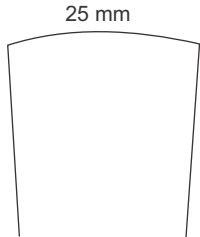

NF.07.34.25



KEY

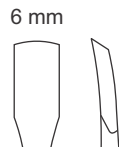

NF.07.35.06  
18 cm / 7 1/8"

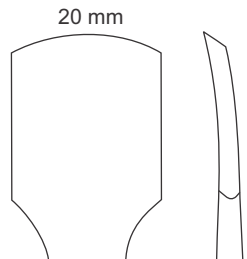

NF.07.35.20  
20 cm / 8"

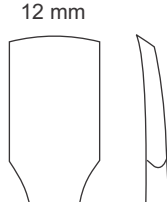

NF.07.35.12  
19 cm / 7 1/2"

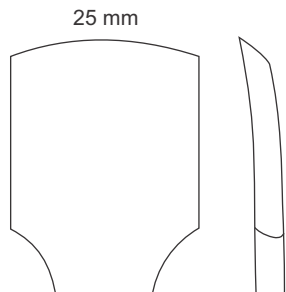

NF.07.35.25  
21 cm / 8 1/4"

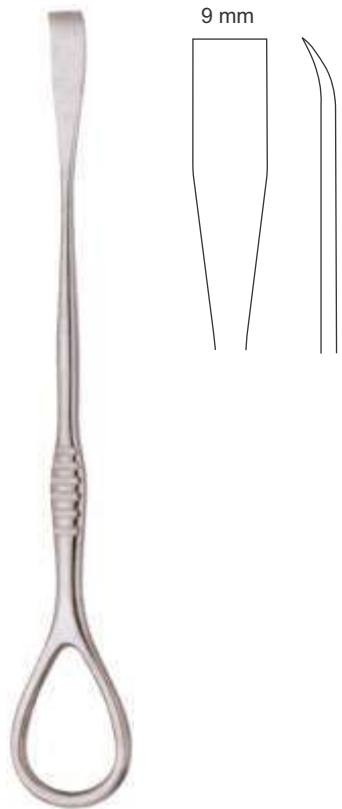

BRISTOW  
NF.07.36.21  
21 cm / 8 1/4"

# Bone Files, Elevators, Raspatories

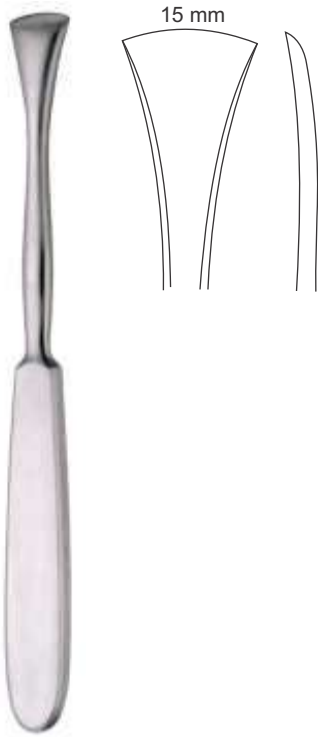

**LANGENBECK**  
NF.07.37.35  
19 cm / 7½"

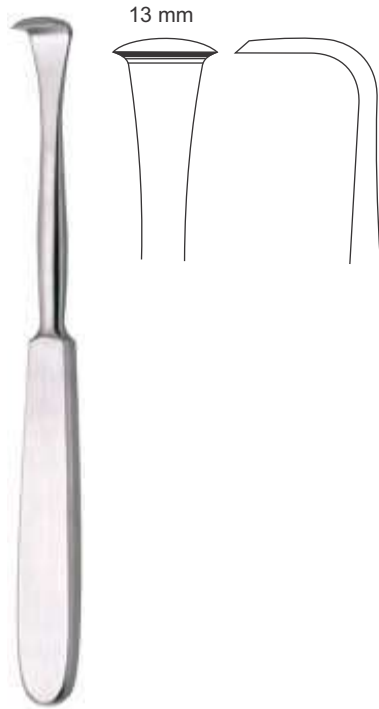

**LANGENBECK**  
NF.07.37.63  
18 cm / 7⅝"



**CUSHING**  
18 cm / 7⅞"

NF.07.38.01

NF.07.38.02



**WANG**  
NF.07.38.18  
18 cm / 7¼"



**WANG**  
NF.07.38.19  
18 cm / 7¼"

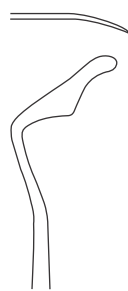

**WANG**  
NF.07.38.28  
18 cm / 7¼"



**WANG**  
NF.07.38.29  
18 cm / 7¼"

# Bone Files, Elevators, Raspatories



28 cm / 11"

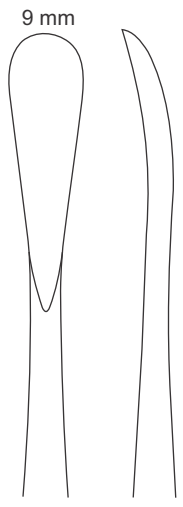

9 mm

NF.07.40.01

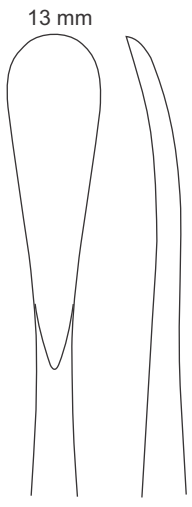

13 mm

NF.07.40.02

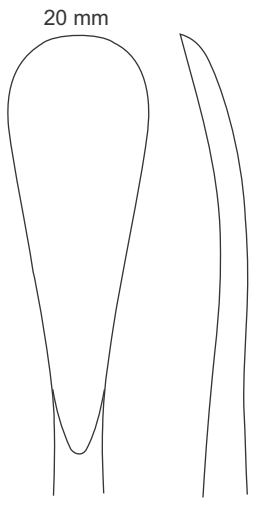

20 mm

NF.07.40.03



29 cm / 11 3/8"

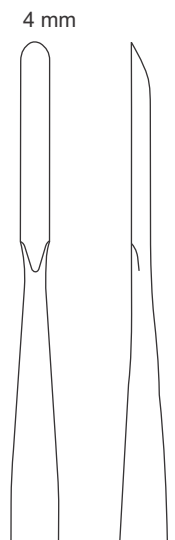

4 mm

NF.07.40.04

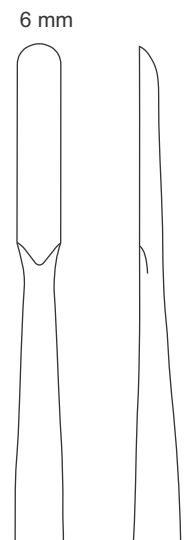

6 mm

NF.07.40.06

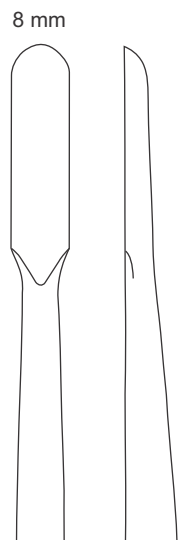

8 mm

NF.07.40.08

# Bone Files, Elevators, Raspatories



semi sharp

**COBB**  
25 cm / 10"

10 mm



NF.07.40.10

13 mm

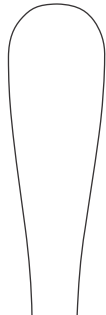

NF.07.40.13

19 mm

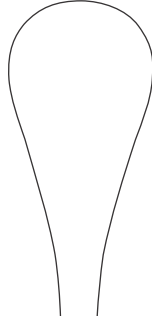

NF.07.40.19

25 mm

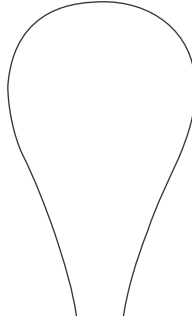

NF.07.40.25

4 mm



NF.07.41.04

5 mm



NF.07.41.05

6 mm



NF.07.41.06



30 cm / 11<sup>3</sup>/<sub>4</sub>"



NF.07.41.28  
28 cm / 11"

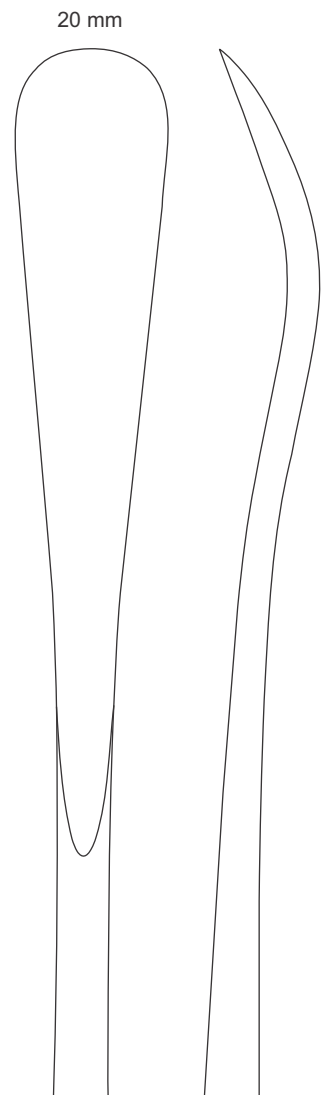

20 mm



**FREER**  
NF.07.42.18  
18 cm / 7<sup>1</sup>/<sub>8</sub>"

# Bone Files, Elevators, Raspatories



**WAGNER**  
33 cm/13"

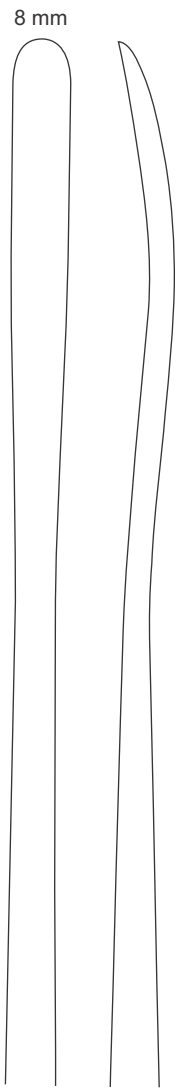

NF.07.42.33

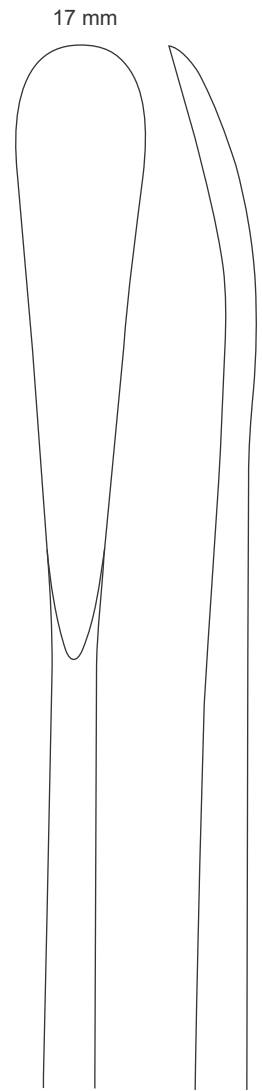

NF.07.42.34



**LANGENBECK**  
20 cm/ 8"

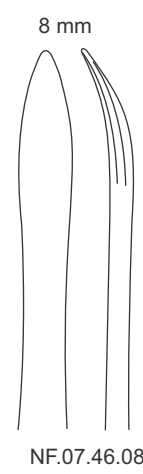

NF.07.46.08

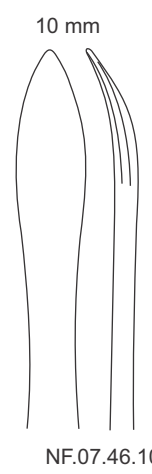

NF.07.46.10

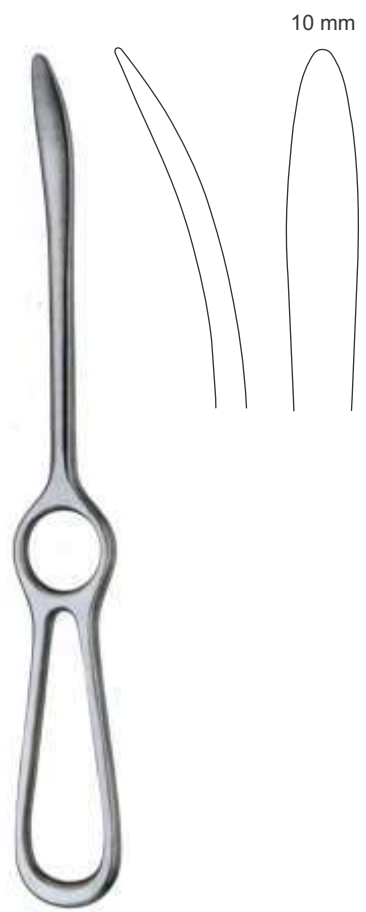

**LANGENBECK**  
NF.07.47.11  
23 cm/ 9"



# Bone Files, Elevators, Raspatories

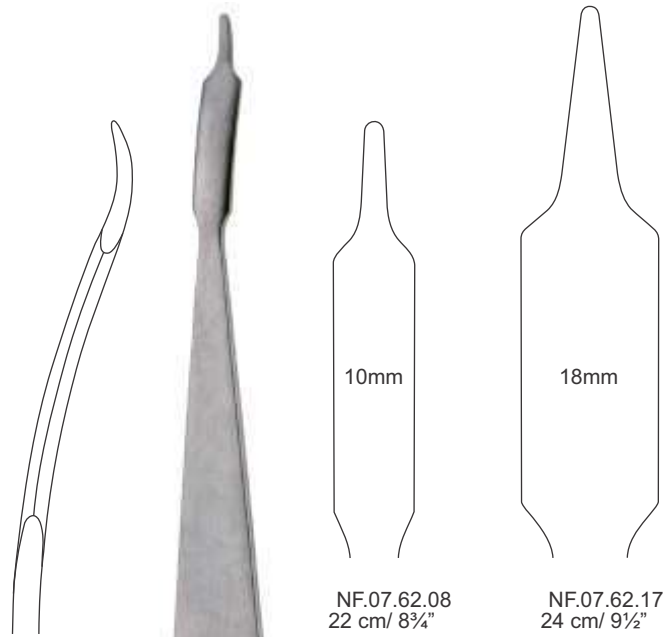
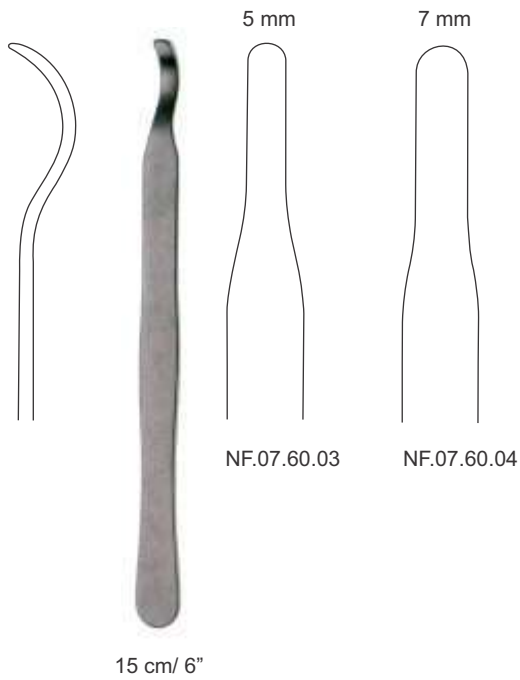

HOHMANN

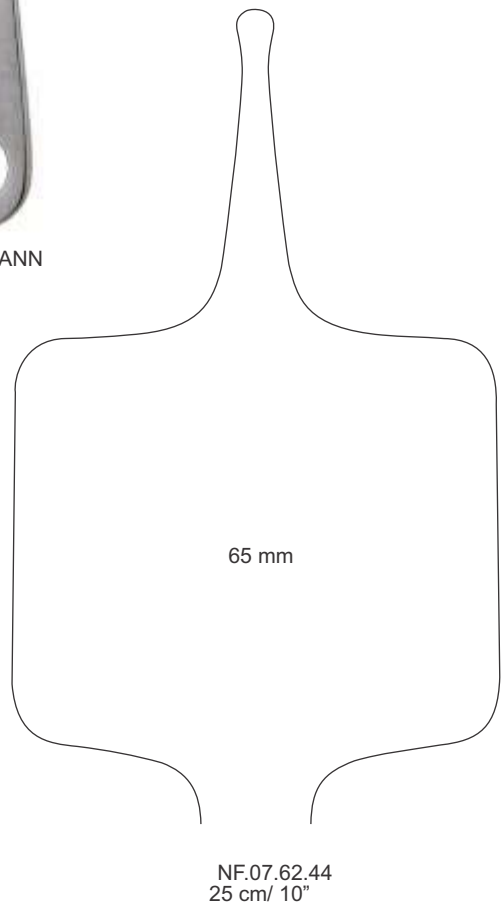
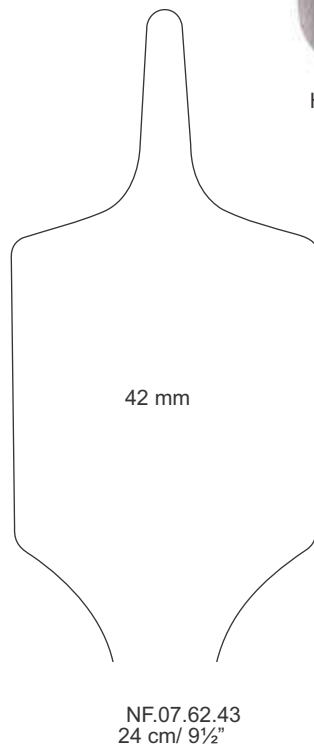

# Bone Files, Elevators, Raspatories

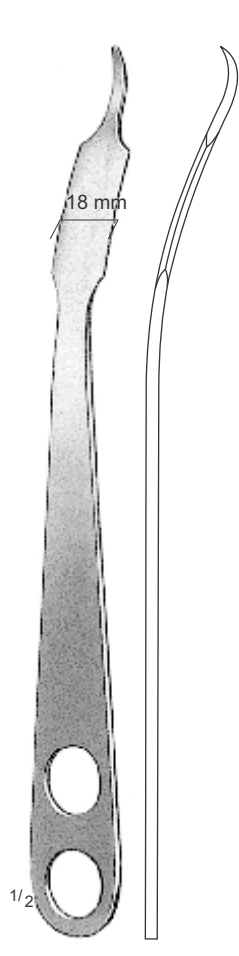

NF.07.62.18  
24 cm / 9½"

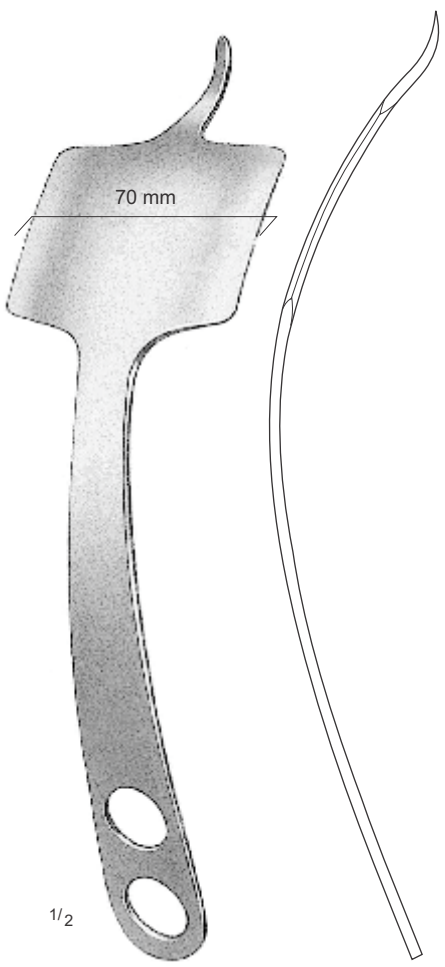

NF.07.62.70  
29 cm / 11½"

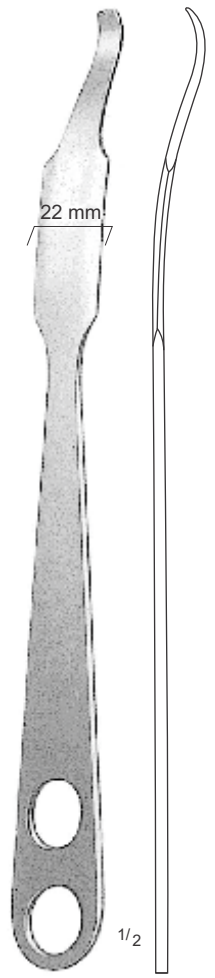

NF.07.64.22  
25 cm / 10"

# Bone Files, Elevators, Raspatories

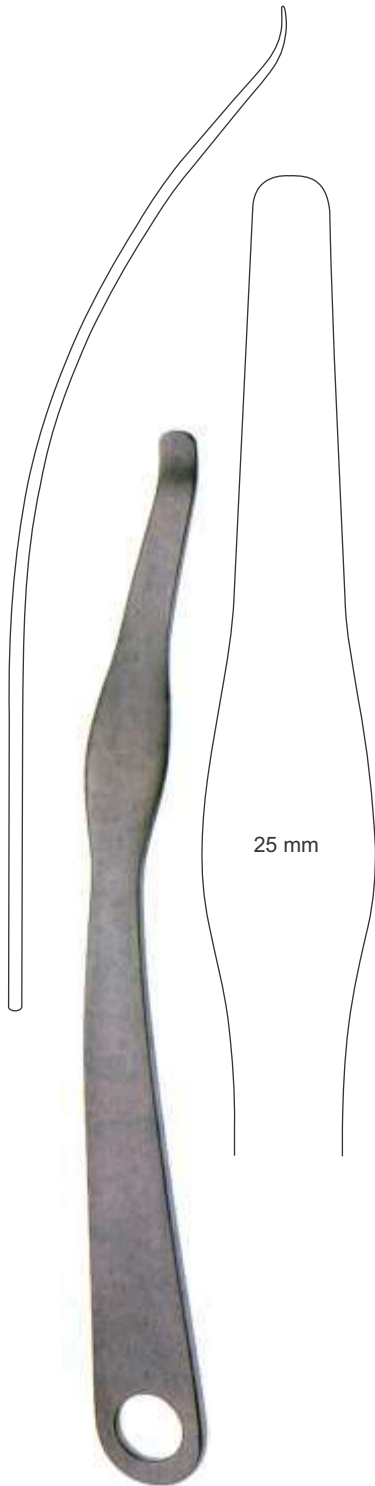

NF.07.64.24  
27 cm / 10<sup>3</sup>/<sub>4</sub>"

25 mm

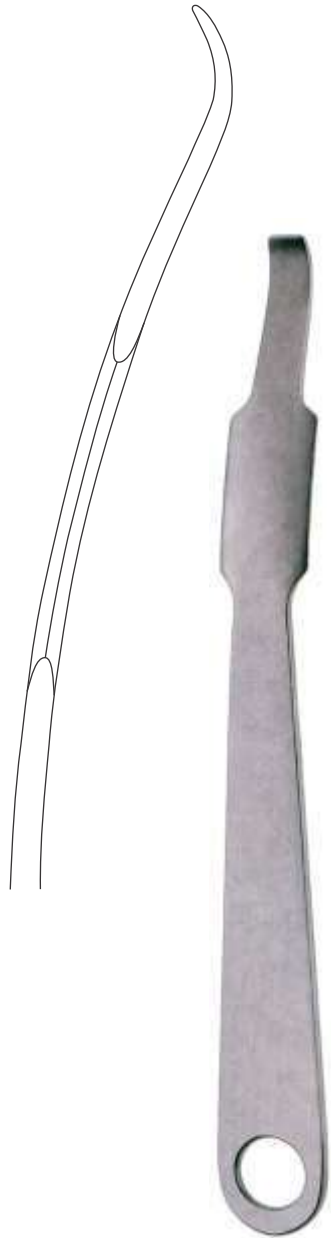

HOHMANN

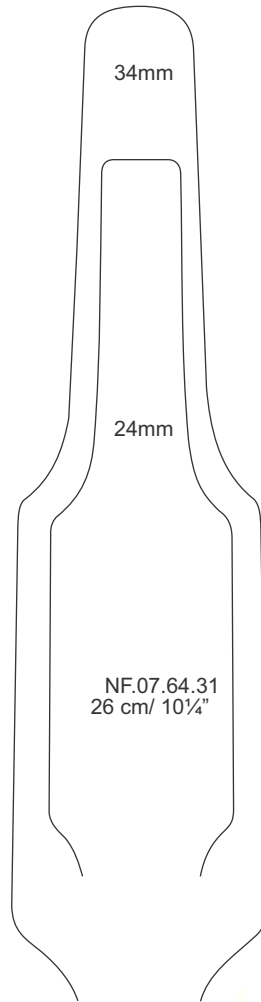

34mm

24mm

NF.07.64.31  
26 cm / 10<sup>1</sup>/<sub>4</sub>"

NF.07.64.3  
29 cm / 11<sup>1</sup>/<sub>2</sub>"

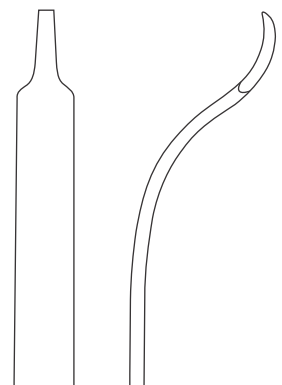

BUCK-GRAMCKO  
NF.07.66.15  
15 cm / 6"

# Bone Files, Elevators, Raspatories

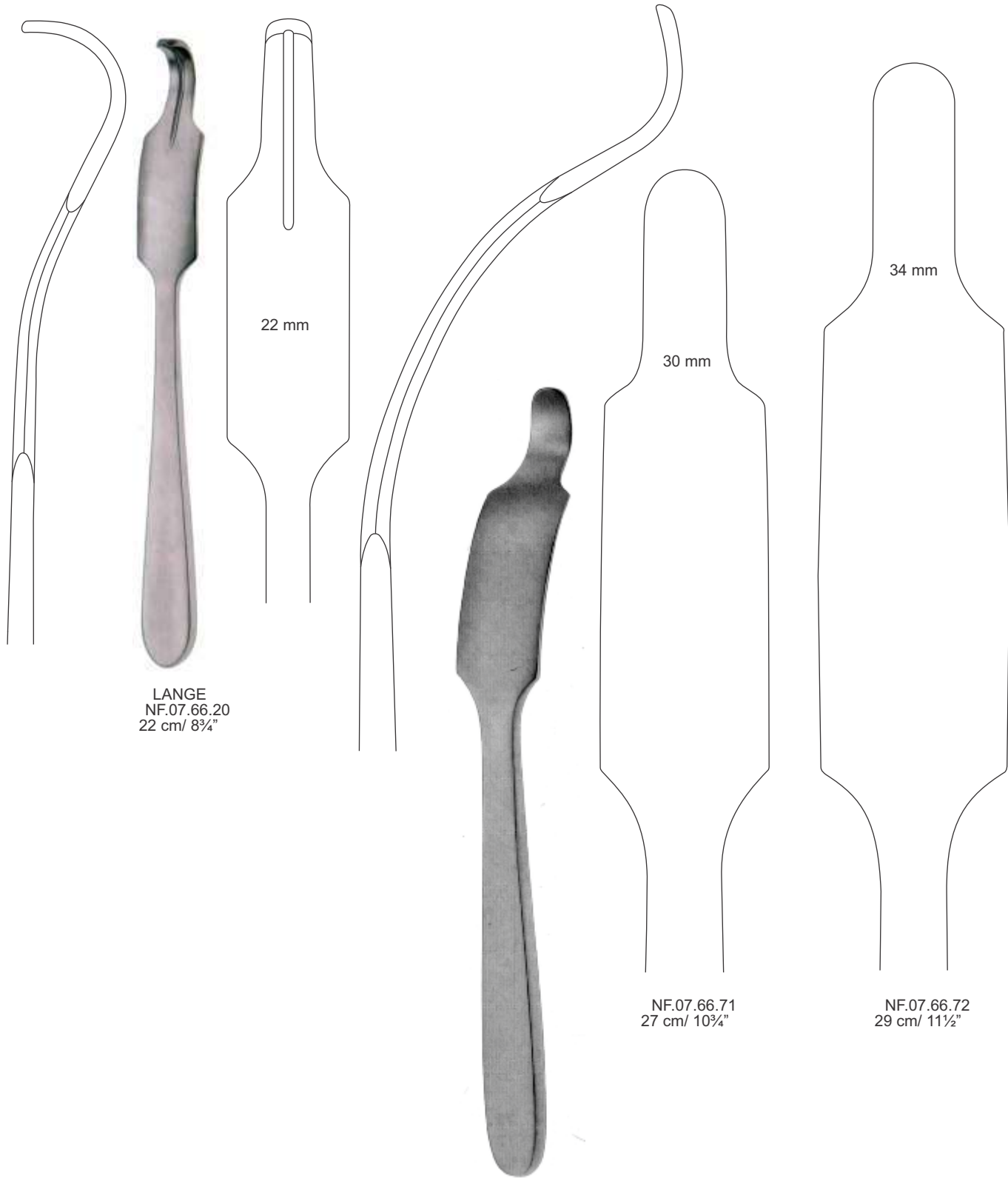

LANGE  
NF.07.66.20  
22 cm / 8<sup>3</sup>/<sub>4</sub>"

22 mm

30 mm

34 mm

NF.07.66.71  
27 cm / 10<sup>3</sup>/<sub>4</sub>"

NF.07.66.72  
29 cm / 11<sup>1</sup>/<sub>2</sub>"

LANGE-HOHMANN

# Bone Files, Elevators, Raspatories

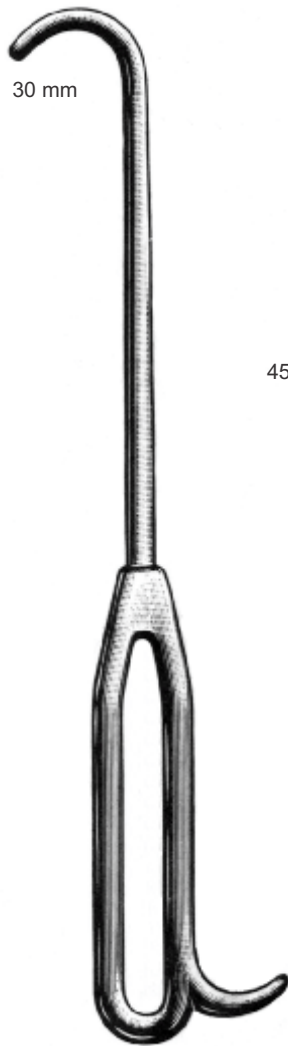

30 mm

LAMBOTTE  
NF.07.68.27  
27 cm/ 10¾"



45 mm wide

BENNET  
NF.07.74.34  
24 cm/ 9½"



43 mm wide

BENNET  
NF.07.74.25  
24 cm/ 9½"



65 mm wide

BENNET  
NF.07.74.44  
24 cm/ 9½"

# Bone Files, Elevators, Raspatories

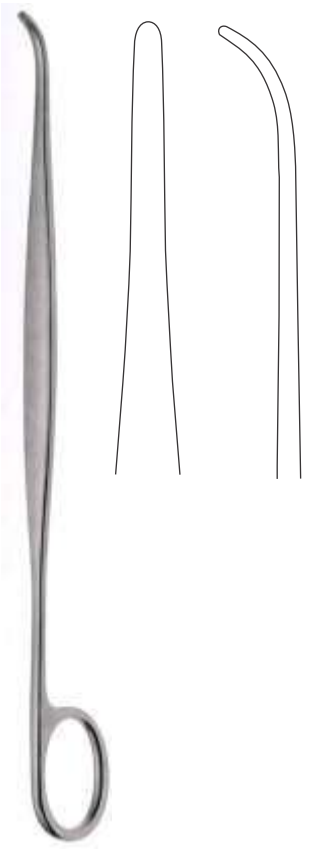

LANE  
NF.07.70.21  
21 cm / 8¼"

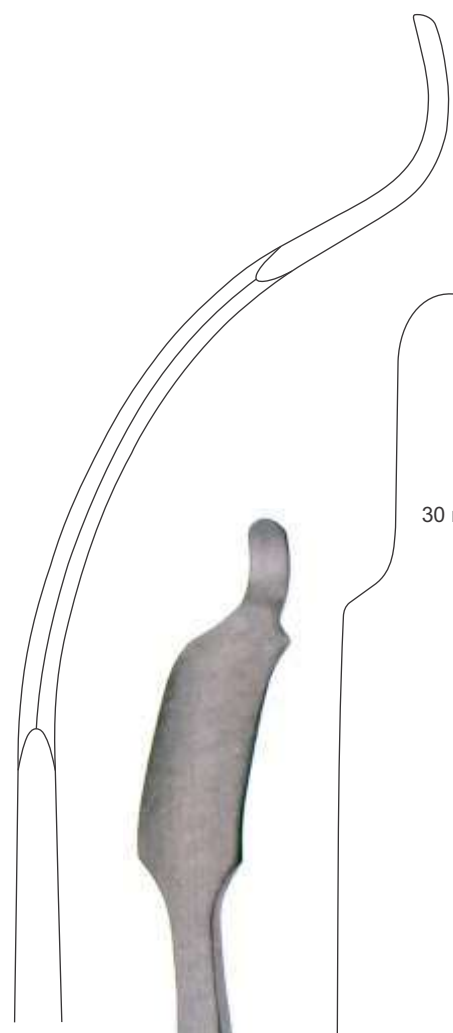

LANGE-HOHMANN  
MODIF.

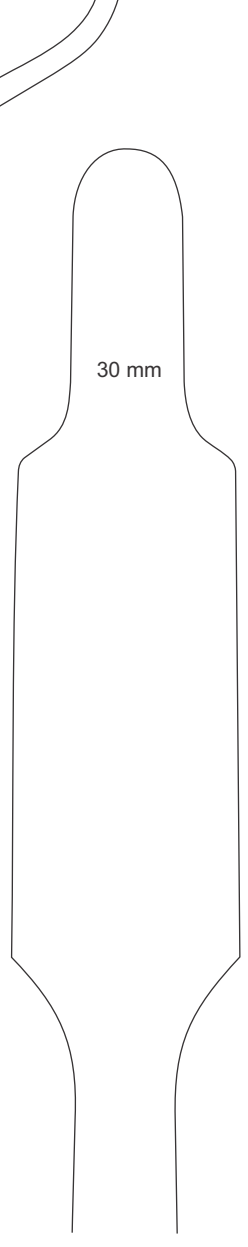

NF.07.71.27  
27 cm / 10¾"

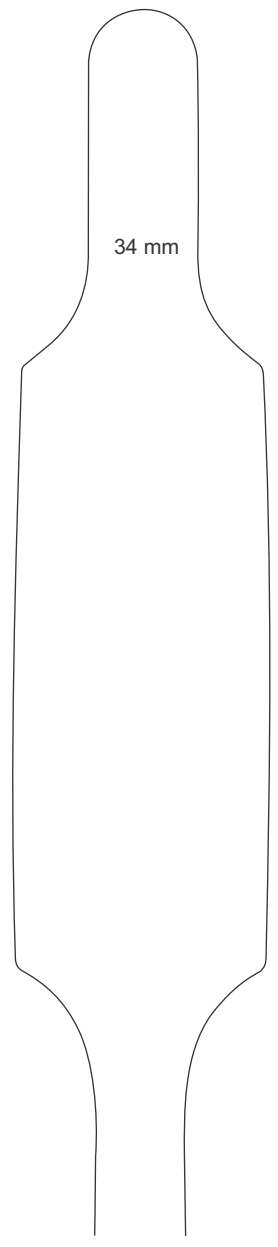

NF.07.71.29  
29 cm / 11½"

# Bone Files, Elevators, Raspatories

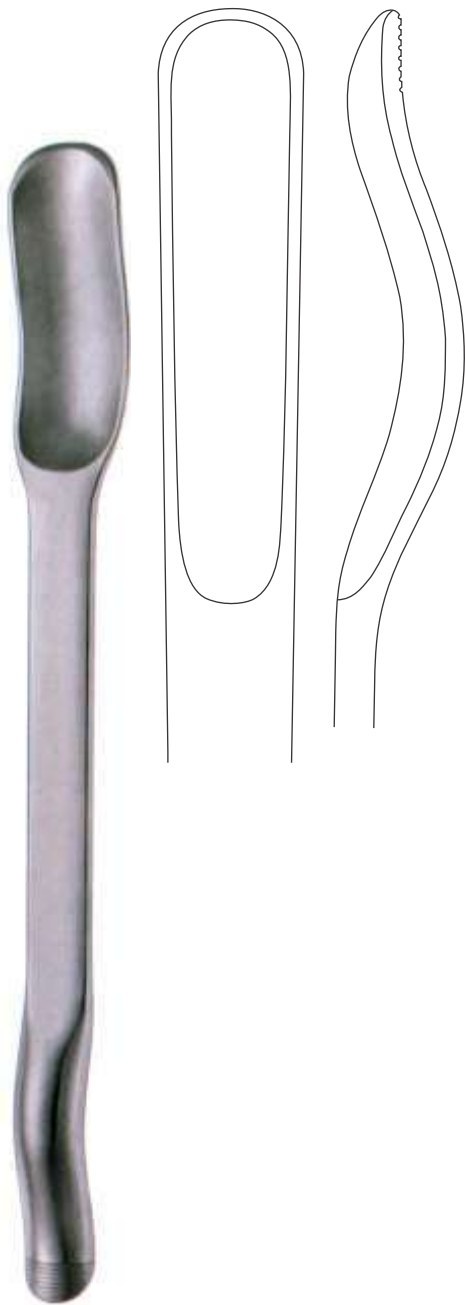

MURPHY-LANE  
NF.07.73.31  
31 cm / 12 $\frac{1}{8}$ "

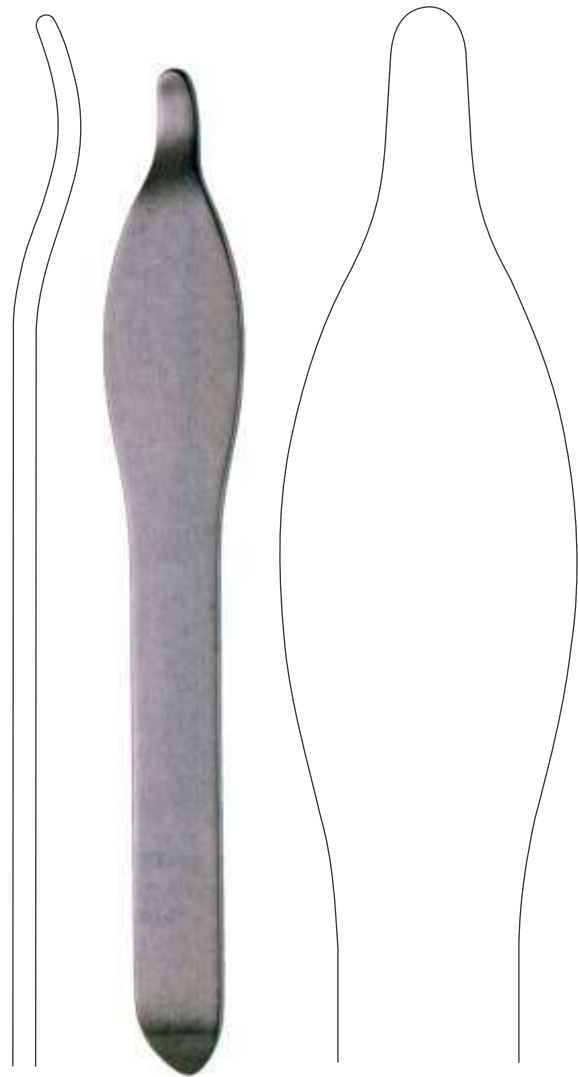

BLOUNT  
NF.07.75.27  
27 cm / 10 $\frac{3}{4}$ "

# Bone Files, Elevators, Raspatories

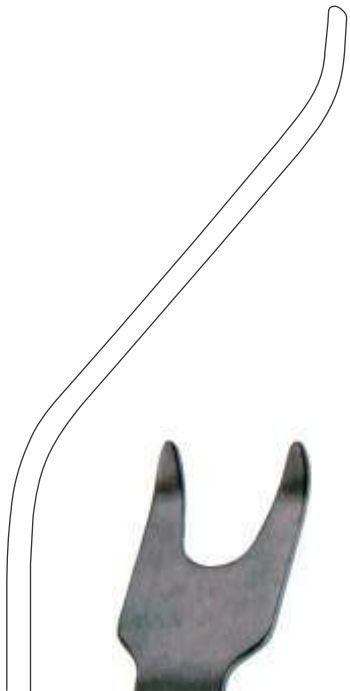

**BLOUNT**  
NF.07.75.52  
25 cm / 10"

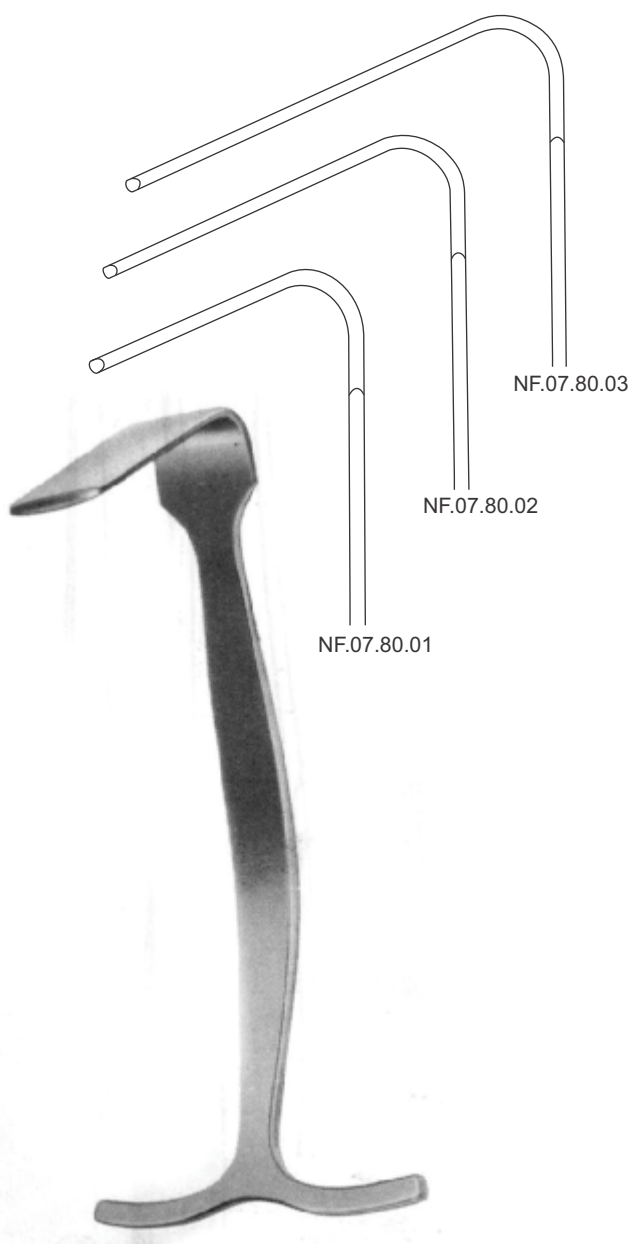
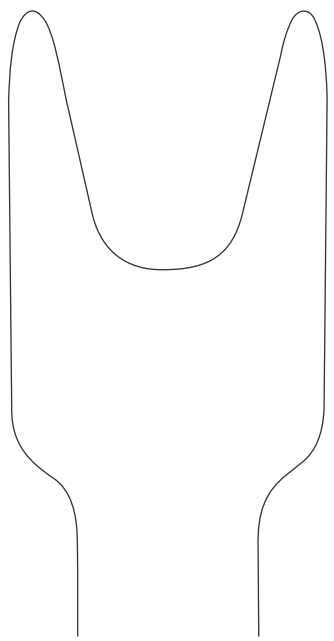

**SMILLIE**  
14 cm / 5½"  
NF.07.80.01 # 1 - 19 x 32 mm  
NF.07.80.02 # 2 - 19 x 45 mm  
NF.07.80.03 # 3 - 19 x 60 mm

NF.07.80.03  
NF.07.80.02  
NF.07.80.01



# Bone Files, Elevators, Raspatories

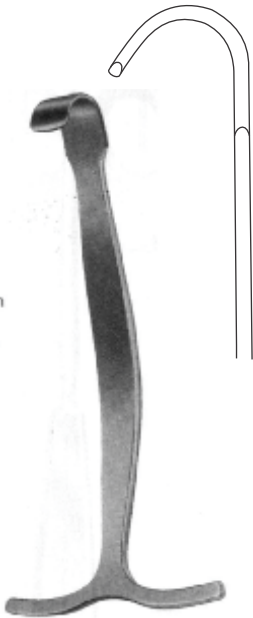

SMILLIE  
NF.07.80.04  
14 cm/ 5½"  
# 4 - 13 x 15 mm



SMILLIE  
NF.07.80.05  
14 cm/ 5½"  
# 6 - 13 x 55 mm

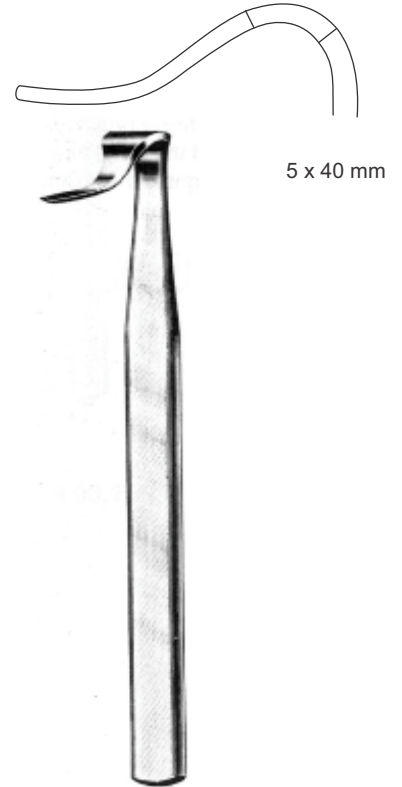

BLOUNT  
NF.07.82.18  
18 cm/ 7¼"

5 x 40 mm



SMILLIE  
NF.07.80.06  
14 cm/ 5½"  
# 5 - 13 x 25 mm



BLOUNT  
24 cm/ 9½"

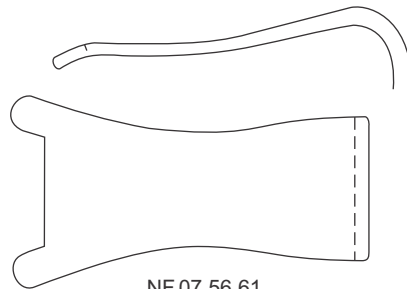

NF.07.56.61  
26 x 43 mm

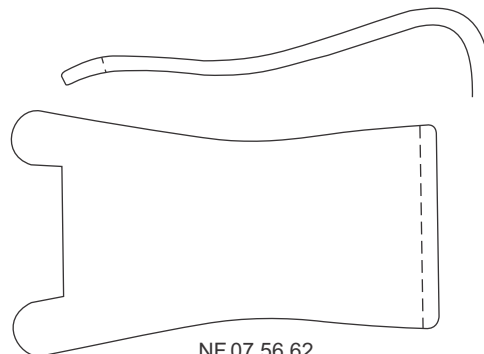

NF.07.56.62  
33 x 54 mm

# Orthopedic Instruments



# Orthopedic Instruments



NF.07.01.15  
No. 18, 15 cm / 6"



NF.07.02.16  
16 cm / 6 1/4"



NF.07.03.23  
23 cm / 9"

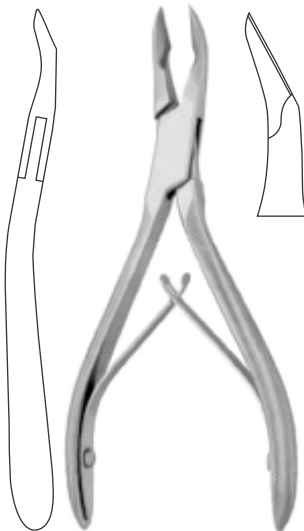
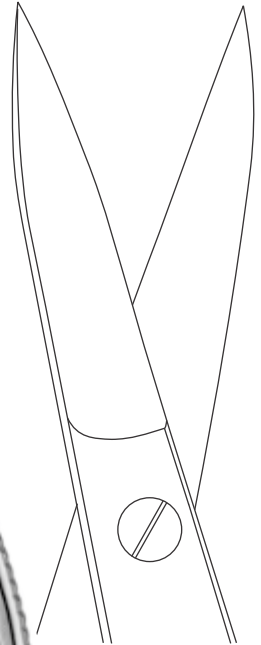

NIRO  
NF.07.04.14  
14 cm / 5 1/2"



CLEVELAND  
NF.07.05.15  
15 cm / 6"

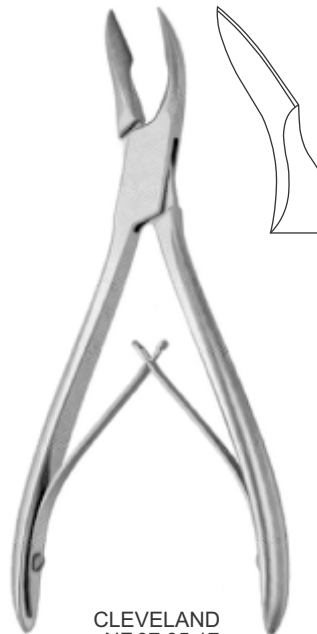

CLEVELAND  
NF.07.05.17  
17 cm / 6 3/4"



LITTAUER  
NF.07.06.15  
15 cm / 6"

# Orthopedic Instruments



**COTTLE-KAZANJIAN**  
NF.07.07.18  
18 cm / 7 1/8"



**COTTLE**  
NF.07.08.18  
18 cm / 7 1/8"



**HORSLEY**  
NF.07.09.19  
19 cm / 7 1/2"



**MEGA CUT®**  
NF.07.100.47  
47 cm / 17 3/4"  
For cutting off  
Kirschner wires,  
Tibia head screws  
bolts, pins upto  
6.0 mm ø  
  
NF.07.100.56  
56 cm / 22 1/2"  
T/C  
For hard wires  
upto ø 2.5 mm



NF.07.10.14  
14 cm / 5 1/2"



NF.07.10.17  
17 cm / 6 3/4"



**LISTON**



NF.07.10.19  
19 cm / 7 1/2"



NF.07.10.22  
22 cm / 8 3/4"

# Orthopedic Instruments



NF.07.11.14  
14 cm / 5½"

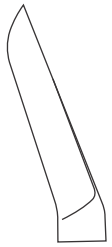

NF.07.11.17  
17 cm / 6¾"



NF.07.12.16  
NO. 6A



NF.07.12.2f  
NO. 6



LISTON

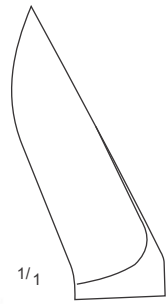

NF.07.11.19  
19 cm / 7½"

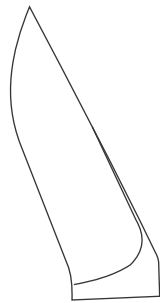

NF.07.11.22  
22 cm / 8¾"



GARDNER  
16 cm / 6¼"



MCINDOE  
NF.07.16.17  
18 cm / 7½"

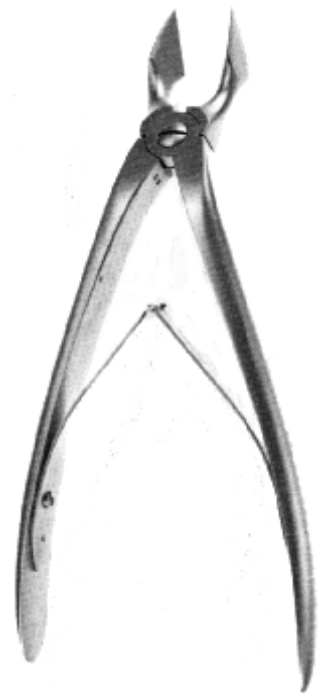

HORSLEY  
NF.07.13.20  
20 cm / 8"



MARKWALDER  
NF.07.14.20  
20 cm / 8"

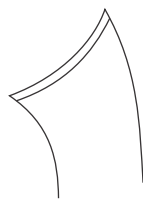

MCINDOE  
18 cm / 7⅞"



NF.07.15.18

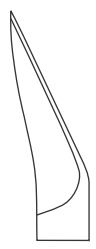

NF.07.15.19

# Orthopedic Instruments

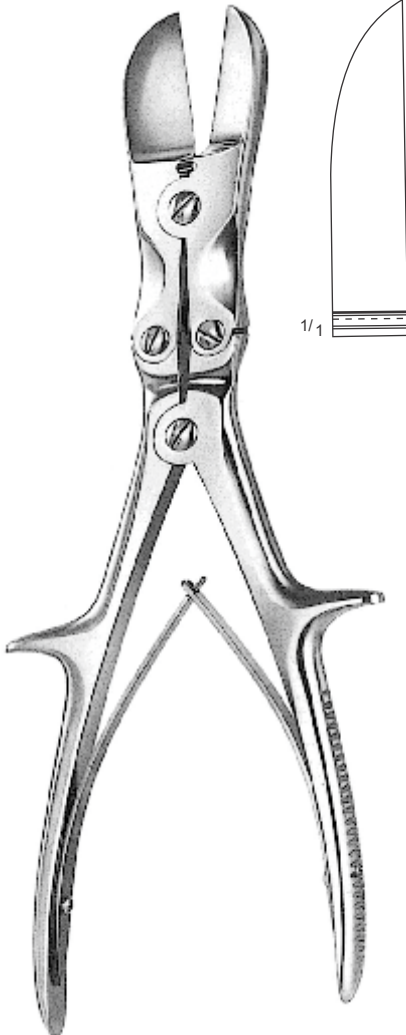

STILLE-LISTON  
NF.07.17.27  
27 cm / 10<sup>3</sup>/<sub>4</sub>"

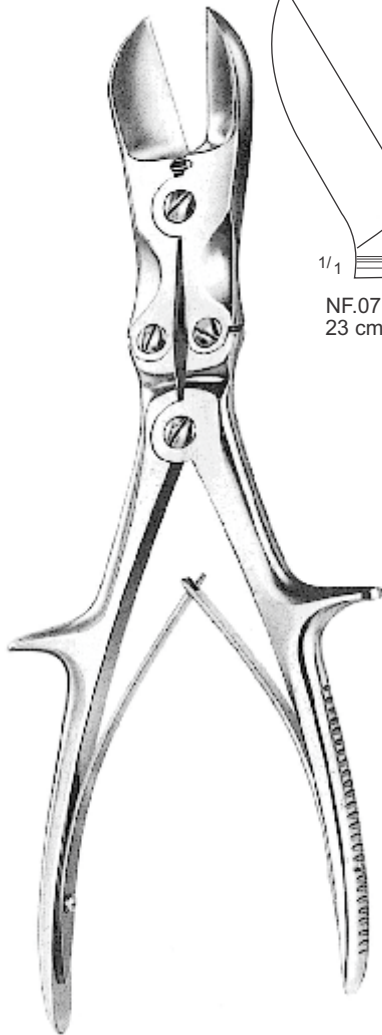

STILLE-LISTON

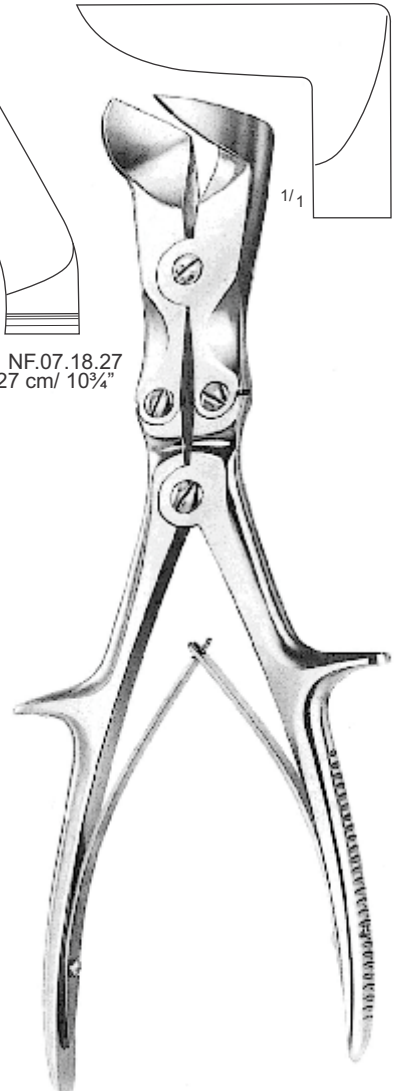
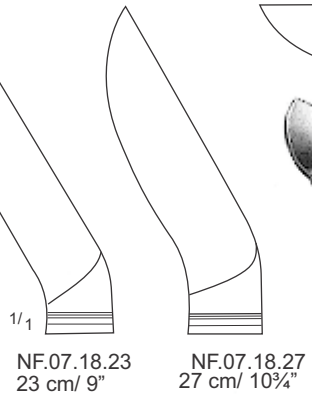

STILLE-LISTON  
NF.07.19.27  
27 cm / 10<sup>3</sup>/<sub>4</sub>"

# Orthopedic Instruments



GERSTER-LOWMAN

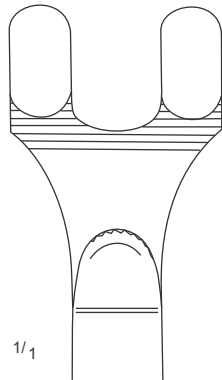
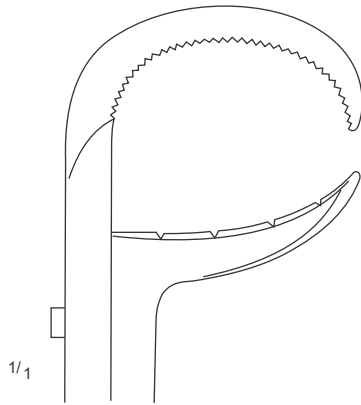

NF.07.35.18  
18 cm / 7 1/4"

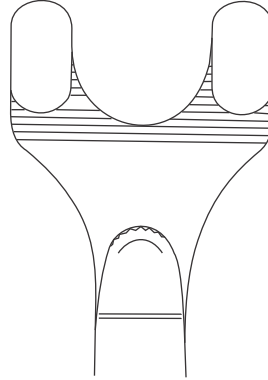

NF.07.35.20  
20 cm / 8"

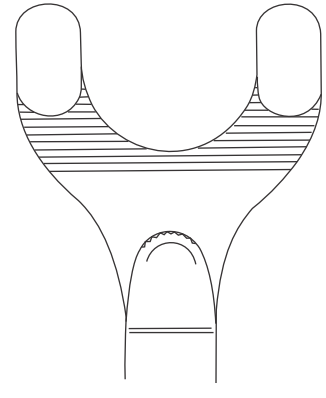

NF.07.35.22  
22 cm / 8 3/4"



VAN BUREN  
NF.07.35.23  
23 cm / 9"

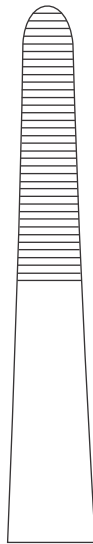

NF.07.36.20  
19 cm / 7 1/2"



DINGMAN  
NF.07.38.19  
19 cm / 7 1/2"

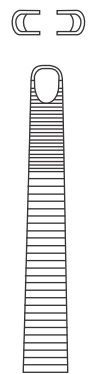

# Orthopedic Instruments



DINGMAN  
NF.07.39.19  
19 cm / 7½"



NF.07.40.21  
21 cm / 8¼"

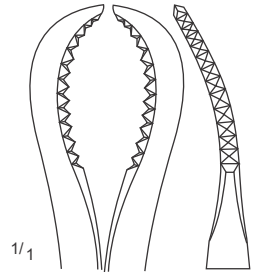

NF.07.41.16  
16 cm / 6¼"

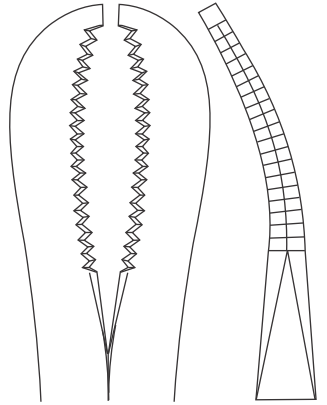

NF.07.42.22  
22 cm / 8¾"

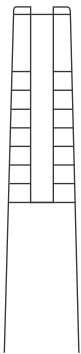

SEMB  
NF.07.43.20  
20 cm / 8"



OBWEGESER  
NF.07.43.45  
15.5 cm / 6½"

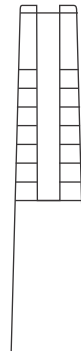

SEMB  
NF.07.44.20  
20 cm / 8"



# Orthopedic Instruments

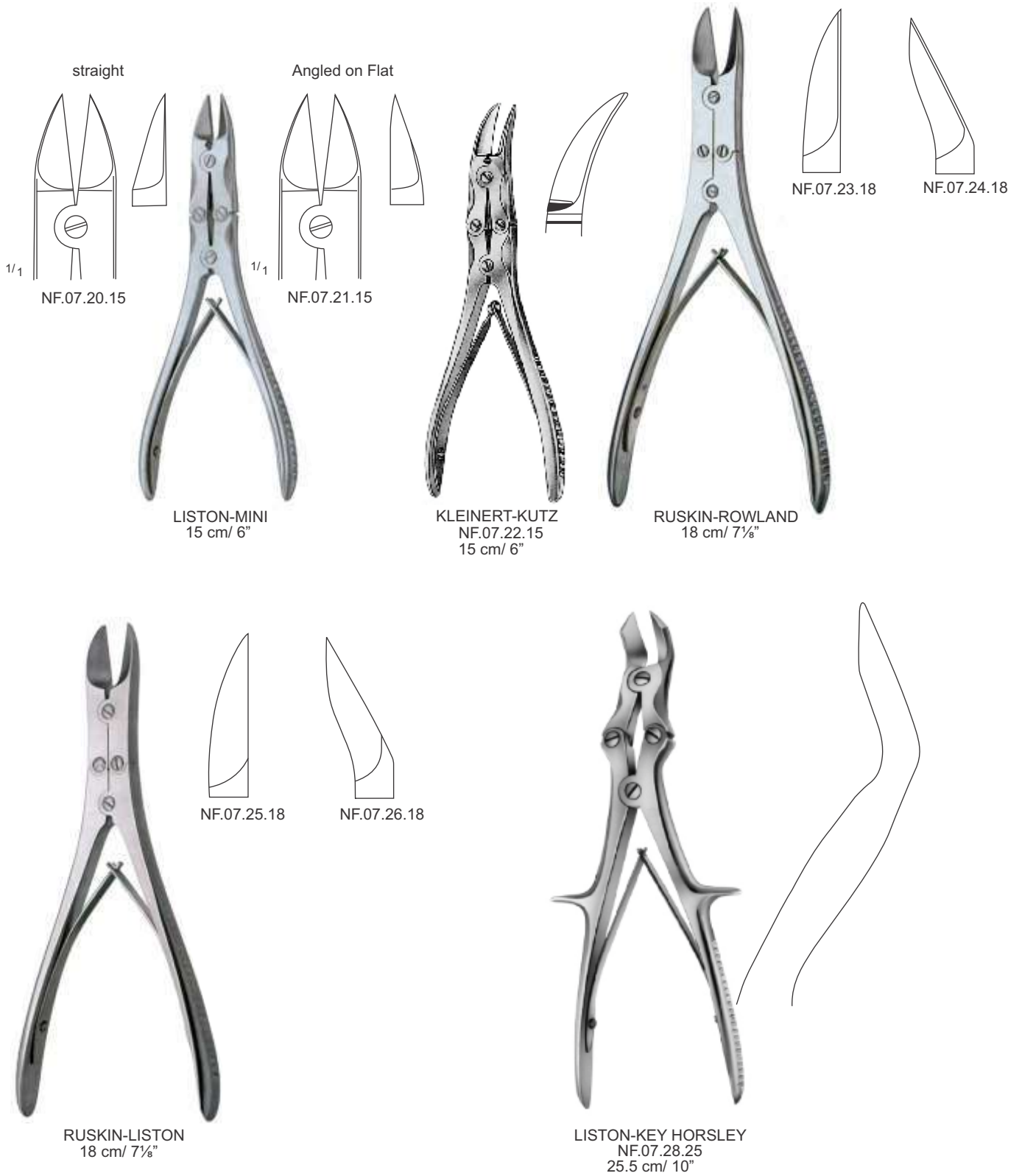

# Orthopedic Instruments



**LISTON-KEY**  
NF.07.28.27  
26 cm/ 10¼"

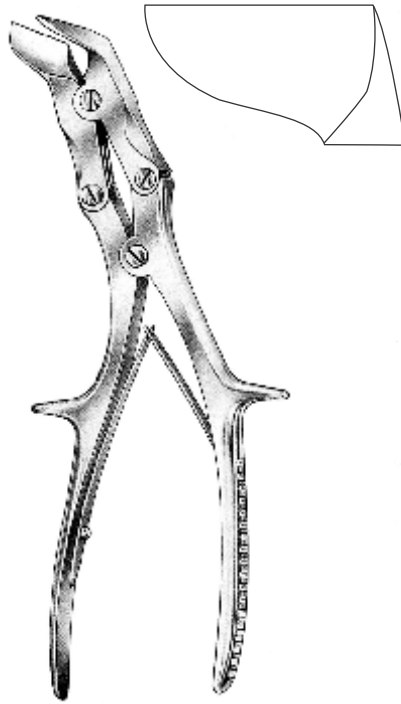

**SEMB**  
NF.07.29.23  
23 cm/ 9"

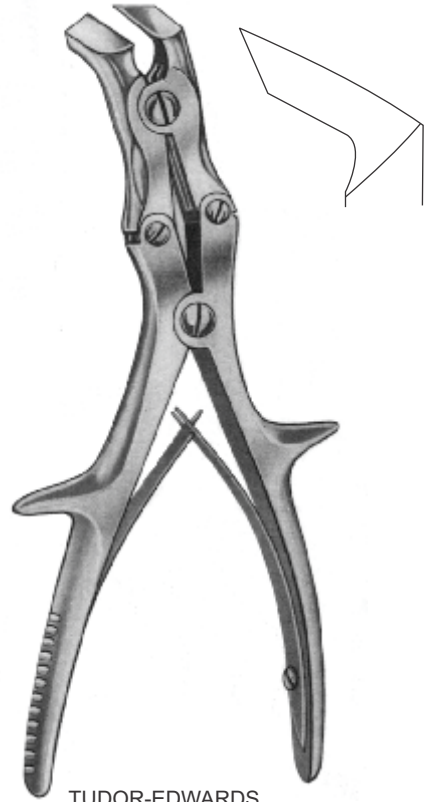

**TUDOR-EDWARDS**  
NF.07.30.23  
23 cm/ 9"



NF.07.31.13  
13.5 cm/ 5¼"



**STEINHAUSER**  
NF.07.32.13  
13 cm/ 5½"



20 cm/ 8"

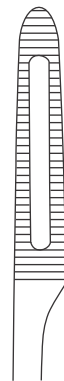

NF.07.33.20

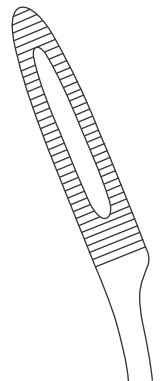

NF.07.34.20

Sequestrum forceps

# Orthopedic Instruments



**ROWE-HARRISON**  
NF.07.45.20  
20 cm / 8"



NF.07.46.14  
14 cm / 5½"

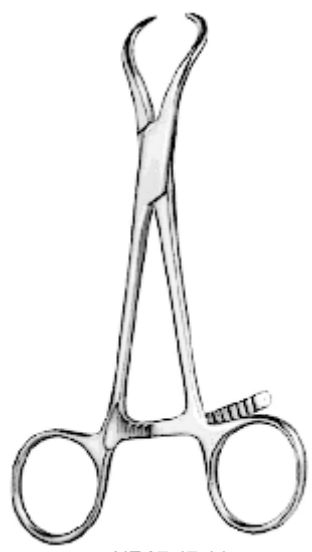

NF.07.47.14  
14 cm / 5½"



NF.07.47.15  
13.5 cm / 5¼"

Wire Twisting Forceps

extra large opening for hand surgery

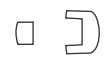

**KISTLER-MANUS**  
NF.07.47.16  
15.5 cm / 6½"

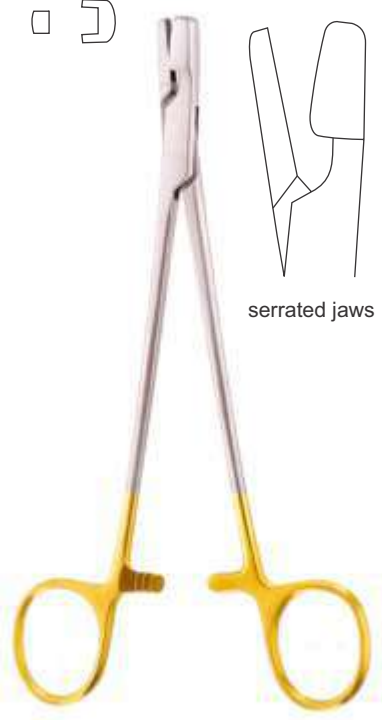

serrated jaws

**"TC"**  
NF.07.48.01  
17 cm / 6¾"



**CORWIN-HEGAR "TC"**  
NF.07.48.03  
16 cm / 6¼"

Cartilage and meniscus forceps

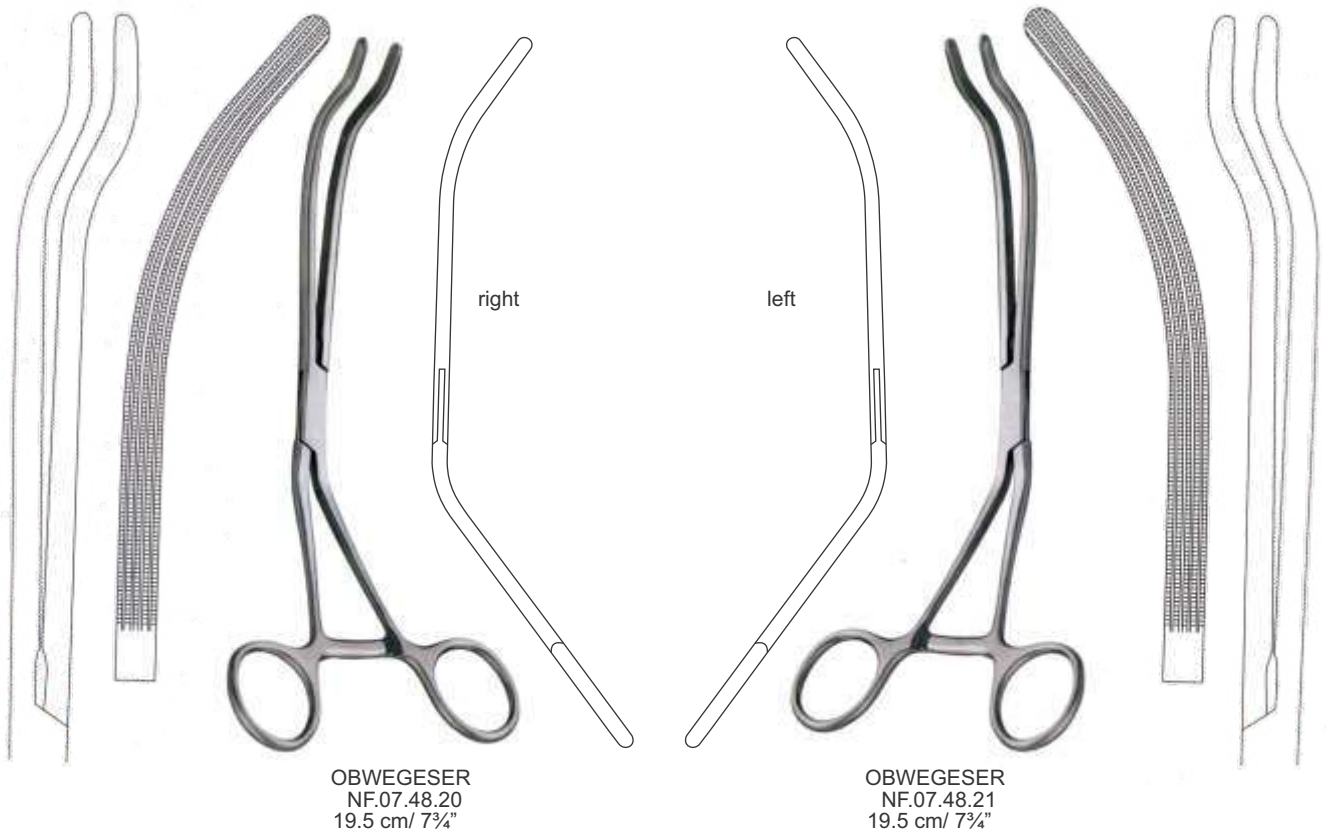

# Orthopedic Instruments

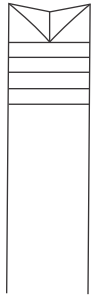

**LANGENBECK**  
NF.07.51.21  
21 cm / 8¼"

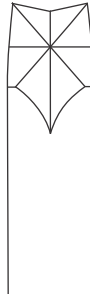

**FERGUSSON**  
NF.07.52.21  
21 cm / 8¼"

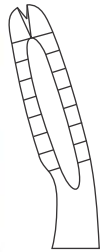

**BIRCHER**  
NF.07.53.20  
20 cm / 8"



**BIRCHER**  
NF.07.54.20  
20 cm / 8"

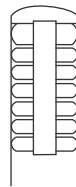

NF.07.55.23  
23 cm / 9"

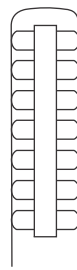

NF.07.55.25  
25 cm / 10"

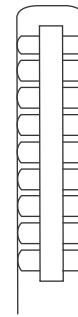

NF.07.55.28  
28 cm / 11"

NF.07.55.24  
23 cm / 9"

NF.07.55.26  
25 cm / 10"

NF.07.55.27  
28 cm / 11"

**ULRICH**



**ULRICH**

# Orthopedic Instruments



NF.07.56.14 14 cm / 5½"  
NF.07.56.17 17 cm / 6¾"  
NF.07.56.21 21 cm / 8¼"  
NF.07.61.23 23 cm / 9"

KERN with ratchet



NF.07.57.14 14 cm / 5½"  
NF.07.60.23 23 cm / 9"

KERN

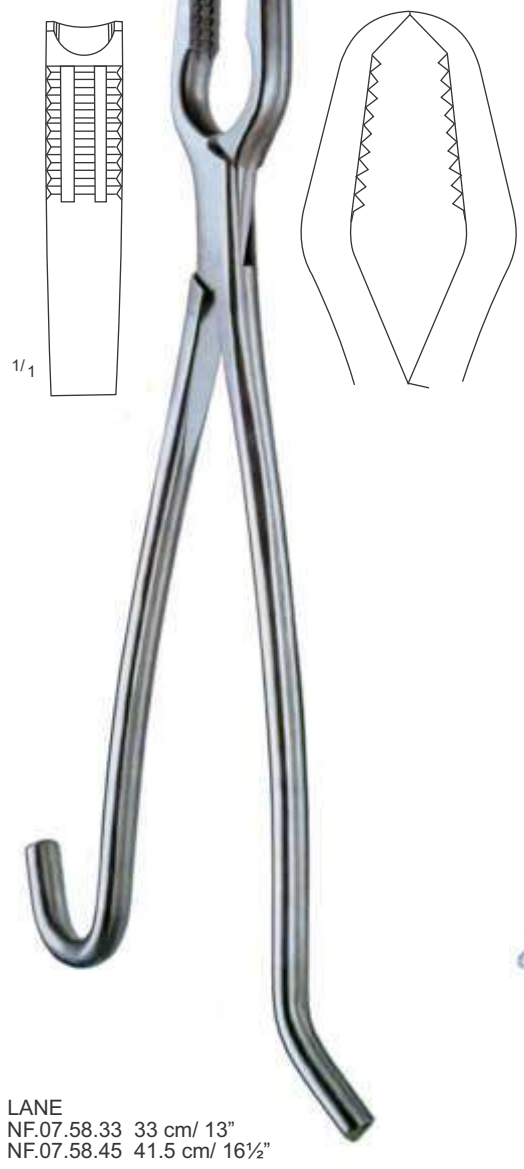

LANE  
NF.07.58.33 33 cm / 13"  
NF.07.58.45 41.5 cm / 16½"

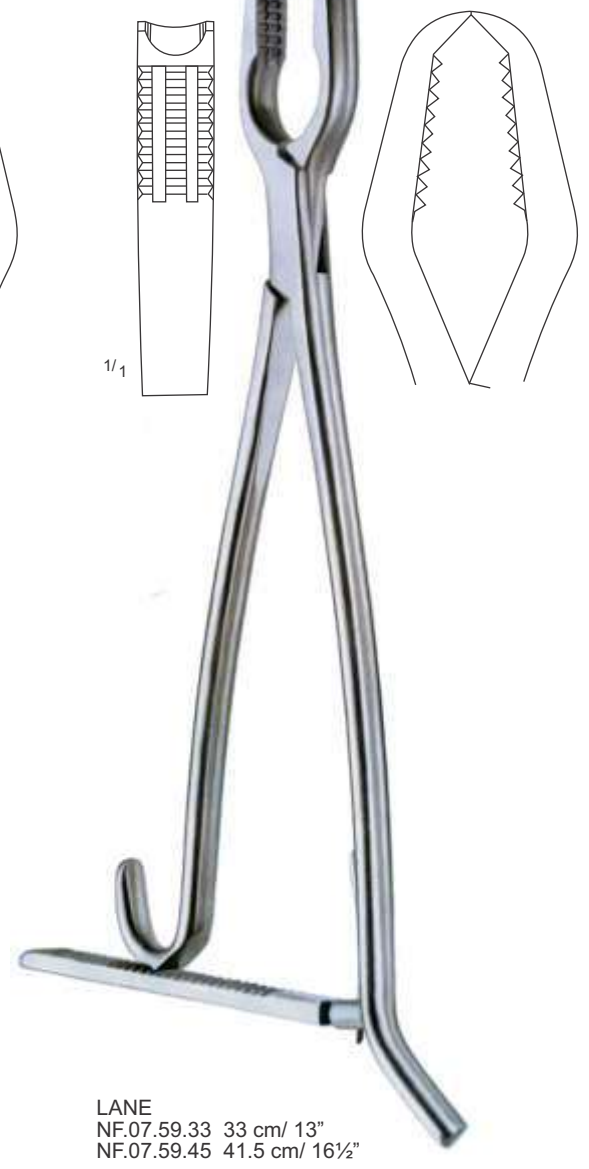

LANE  
NF.07.59.33 33 cm / 13"  
NF.07.59.45 41.5 cm / 16½"



**LAMBOTTE**  
NF.07.62.21 - 21 cm / 8¼"  
NF.07.62.25 - 25 cm / 10"  
NF.07.62.30 - 30 cm / 11¼"

**LAMBOTTE**  
NF.07.63.21 - 21 cm / 8¼"  
NF.07.63.26 - 26 cm / 10¼"  
NF.07.63.33 - 30 cm / 11¼"

**FARABEU**  
NF.07.64.23 23 cm / 9"  
NF.07.64.25 25 cm / 10"

# Orthopedic Instruments

Bone holding clamps

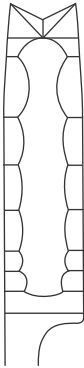

**FARABEU-F-LAMBOTTE**  
NF.07.65.26  
26 cm / 10¼"



**VERBRUGGE**  
NF.07.66.17  
17.5 cm / 7"

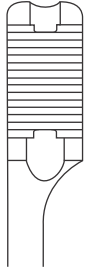

**VERBRUGGE**  
NF.07.67.25 25 cm / 10"  
NF.07.67.26 26 cm / 10¼"  
NF.07.67.27 27 cm / 10¾"



# Orthopedic Instruments

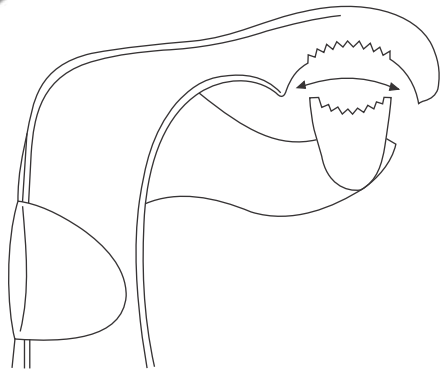
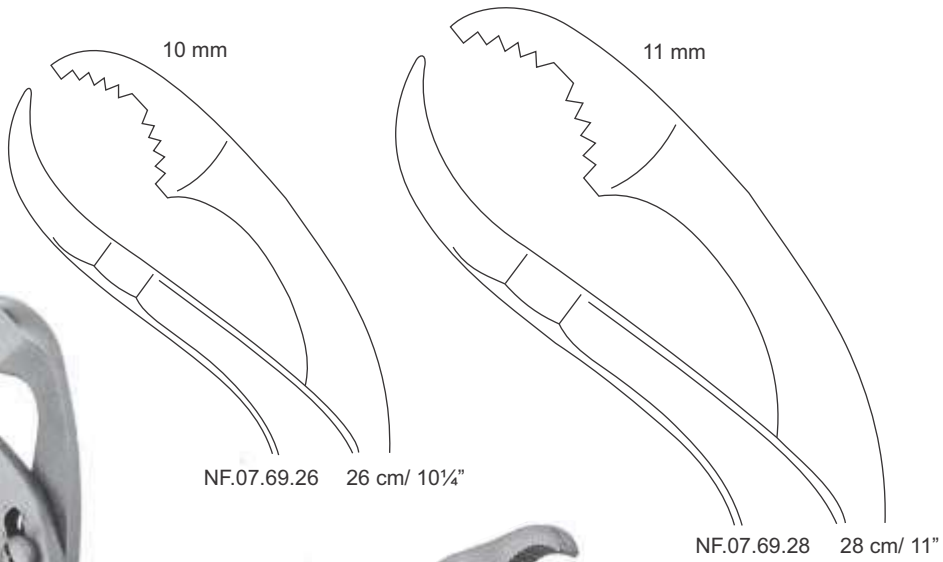
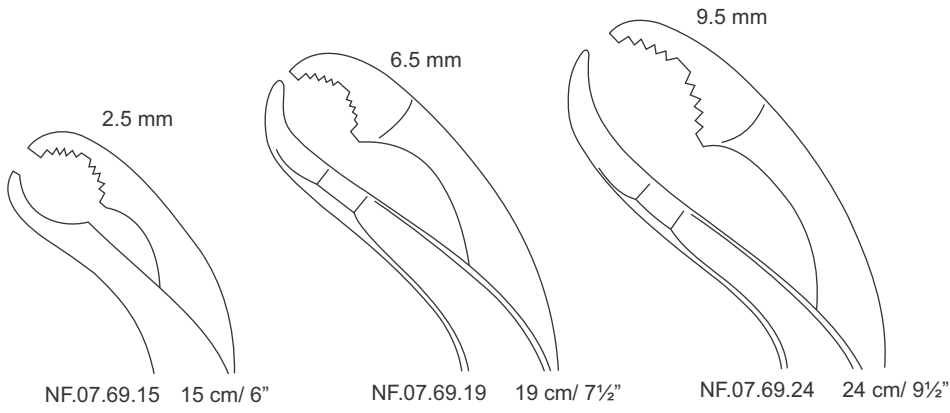

LAMBOTTE  
NF.07.68.21 - 21 cm / 8¼"  
NF.07.68.23 - 23 cm / 9"

# Orthopedic Instruments

NF.07.73.01 12 mm  
NF.07.73.02 18 mm  
Spare blades

NF.07.72.30  
Spare blade



NF.07.70.14  
17.5 cm - 7"



LANGENBECK  
NF.07.70.23  
23 cm - 9"



CHARRIERE  
NF.07.71.27 - 27 cm/10<sup>3</sup>/<sub>4</sub>"  
NF.07.71.30 - 30 cm/11<sup>3</sup>/<sub>4</sub>"  
NF.07.71.34 - 34 cm/13<sup>3</sup>/<sub>8</sub>"



SATTERLEE  
NF.07.72.29  
29 cm - 11<sup>1</sup>/<sub>2</sub>"



CHARRIERE  
NF.07.73.35  
35 cm - 13<sup>3</sup>/<sub>4</sub>"

# Orthopedic Instruments



NF.07.73.04 4 mm  
NF.07.73.06 6 mm  
NF.07.73.08 8 mm  
Spare blades

**BIER**  
NF.07.73.42  
42 cm - 16½"

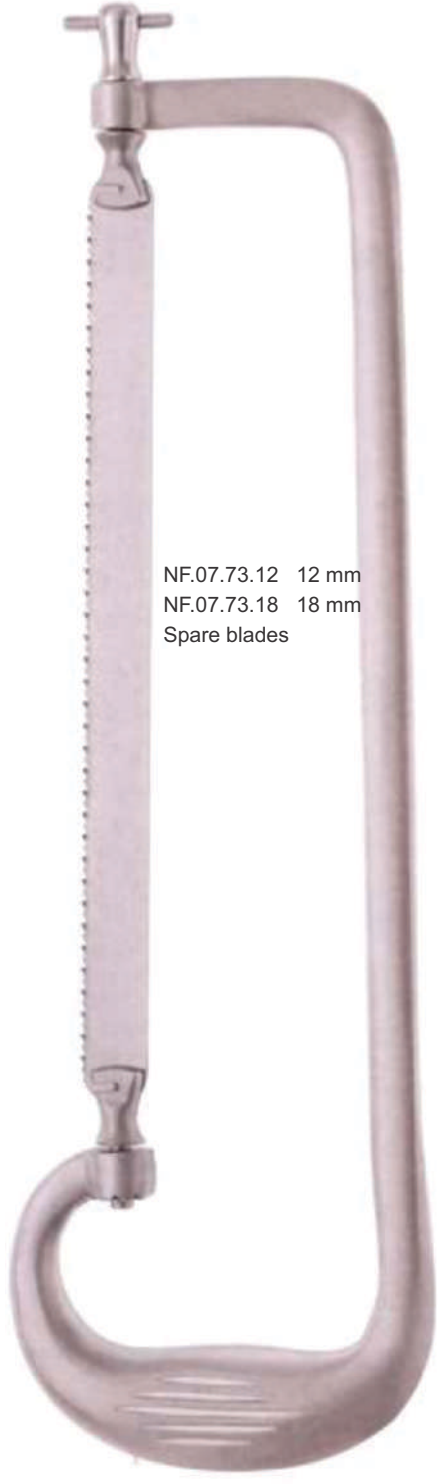

NF.07.73.12 12 mm  
NF.07.73.18 18 mm  
Spare blades

**RUST**  
NF.07.73.38  
38 cm/ 15"

# Orthopedic Instruments



GIGLI  
NF.07.74.02  
(Pair of Handles)

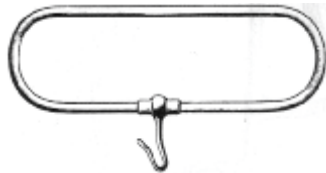

GIGLI  
NF.07.74.06  
(Supplied In Pairs)



GIGLI  
NF.07.74.30 - 30 cm / 11 3/4"  
NF.07.74.40 - 40 cm / 15 3/4"  
NF.07.74.50 - 50 cm / 19 3/4"  
NF.07.74.60 - 60 cm / 23 3/4"  
NF.07.74.70 - 70 cm / 27 1/2"



DeMARTEL  
wire saw guide  
NF.07.74.80  
33 cm / 13"

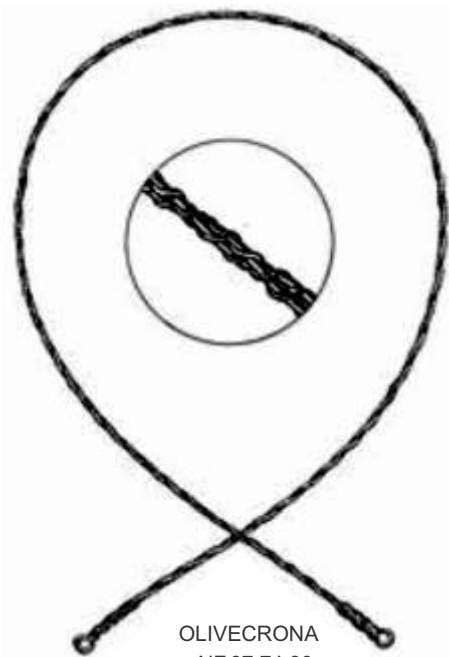

OLIVECRONA  
NF.07.74.90  
50 cm / 20"



NF.07.76.12  
9 x 16 cm  
3 1/2" - 6 1/4"  
Complete with 1 nail Ø 4 mm x 15 cm  
for arm

NF.07.76.13  
11 x 21 cm  
4 3/8" - 8 1/4"  
Complete with 1 nail Ø 4 mm x 18 cm  
for knee and femur

NF.07.76.15  
15 x 21 cm  
3" - 8 1/4"  
Complete with 1 nail Ø 4 mm x 21 cm  
for knee and femur

# Orthopedic Instruments



ERICH  
NF.07.75.05  
Roll/1 m



Arch bars

ERICH  
NF.07.75.10  
14 cm/ 5½"  
packing unit 12 pieces  
tück

Arch bars



SCHUCHARDT  
NF.07.75.01  
packing unit 12 pieces



DAUTREY  
NF.07.75.23  
15 cm - 6"



SCHUCHARDT  
NF.07.75.02  
packing unit 12 pieces



Coil 10 m (33.3 ft.), soft

- NF.07.74.17 Ø 0.25 mm - 31 G
- NF.07.74.18 Ø 0.30 mm - 29 G
- NF.07.74.19 Ø 0.40 mm - 27 G
- NF.07.74.20 Ø 0.50 mm - 25 G
- NF.07.74.21 Ø 0.60 mm - 23 G
- NF.07.74.22 Ø 0.70 mm - 22 G
- NF.07.74.23 Ø 0.80 mm - 21 G
- NF.07.74.24 Ø 0.90 mm - 20 G
- NF.07.74.25 Ø 1.00 mm - 19 G
- NF.07.74.32 Ø 1.20 mm - 18 G
- NF.07.74.33 Ø 1.50 mm - 17 G
- NF.07.74.34 Ø 1.80 mm - 15 G
- NF.07.74.35 Ø 2.00 mm - 14 G



NF.07.78.05  
with three-jaw chuck, locked  
by hand, max. spread 8 mm



NF.07.78.07  
with Jacobs three-jaw chuck and tightening  
wrench max. spread 7 mm

# Orthopedic Instruments



Wire pusher

MERSHON  
NF.07.04.50  
14.5 cm - 5¾"



NIRO  
NF.07.04.15  
14 cm - 5½"



NIRO "TC"  
NF.07.04.65  
14 cm - 5½"



MEDICON  
NF.07.80.07  
17 cm - 6¾"



MEDICON "TC"  
NF.07.80.17  
17 cm - 6¾"

# Orthopedic Instruments

Bone drill



CHAMPIONNIER  
NF.07.79.17  
17 cm - 6¾"



REAMER  
NF.07.79.54  
15 cm - 6"



PERTHES  
NF.07.79.21  
21 cm - 8¼"



PERTHES  
NF.07.79.41  
22 cm - 8¾"

complete with 3 traction hooks



NF.07.79.26  
16 cm - 6¼"



K.WIRE (KIRSCHNER)  
NF.07.79.01 small pattern  
NF.07.79.02 large pattern

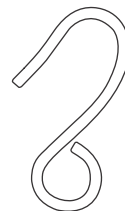

NF.07.79.71  
Traction hook only, small

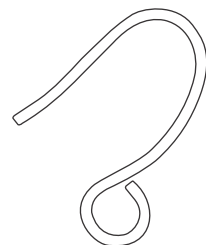

NF.07.79.72  
Traction hook only, large

# Orthopedic Instruments



NF.07.78.21  
small pattern

a = 4.5 - 13 cm  
1 3/4" - 5 1/8"  
b = 10 cm  
4"

NF.07.78.23  
large pattern

a = 7 - 19 cm  
2 3/4" - 7 1/2"  
b = 16 cm  
6 1/4"

**KIRSCHNER**  
complete with 3 traction hooks



NF.07.78.25  
15 cm - 6"  
Tightening wrench



# Orthopedic Instruments



NF.07.80.01



NF.07.80.02

17 cm / 6¾"

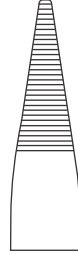

NF.07.80.29  
19 cm / 7½"



NF.07.80.15  
15 cm / 6"  
"TC"



UNIVERSAL  
NF.07.82.15  
15 cm / 6"



18 cm / 7½"

5 mm



NF.07.84.08

7 mm



NF.07.85.08



NF.07.86.08



18 cm / 7½"



NF.07.83.18



NF.07.84.18



NF.07.85.18

# Orthopedic Instruments



ALITUR "TC"  
NF.07.87.03  
3 mm jaws  
  
NF.07.87.06  
6 mm jaws  
18cm/ 7<sup>1</sup>/<sub>8</sub>"



NF.07.88.18  
18 cm/ 7<sup>1</sup>/<sub>8</sub>"



NF.07.88.20  
20 cm/ 8"

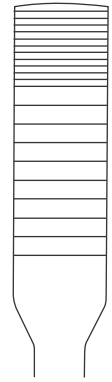

NF.07.88.24  
24 cm/ 9<sup>1</sup>/<sub>2</sub>"

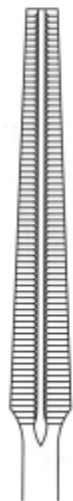

NF.07.89.22  
22 cm/ 8<sup>3</sup>/<sub>4</sub>"

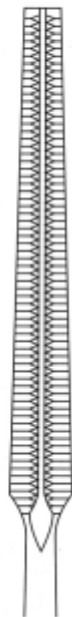

NF.07.89.25  
25 cm/ 10"

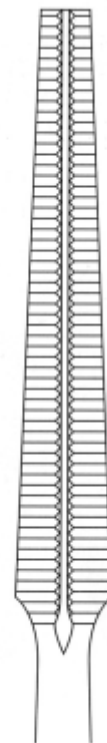

NF.07.89.30  
30 cm/ 11<sup>1</sup>/<sub>4</sub>"



# Orthopedic Instruments

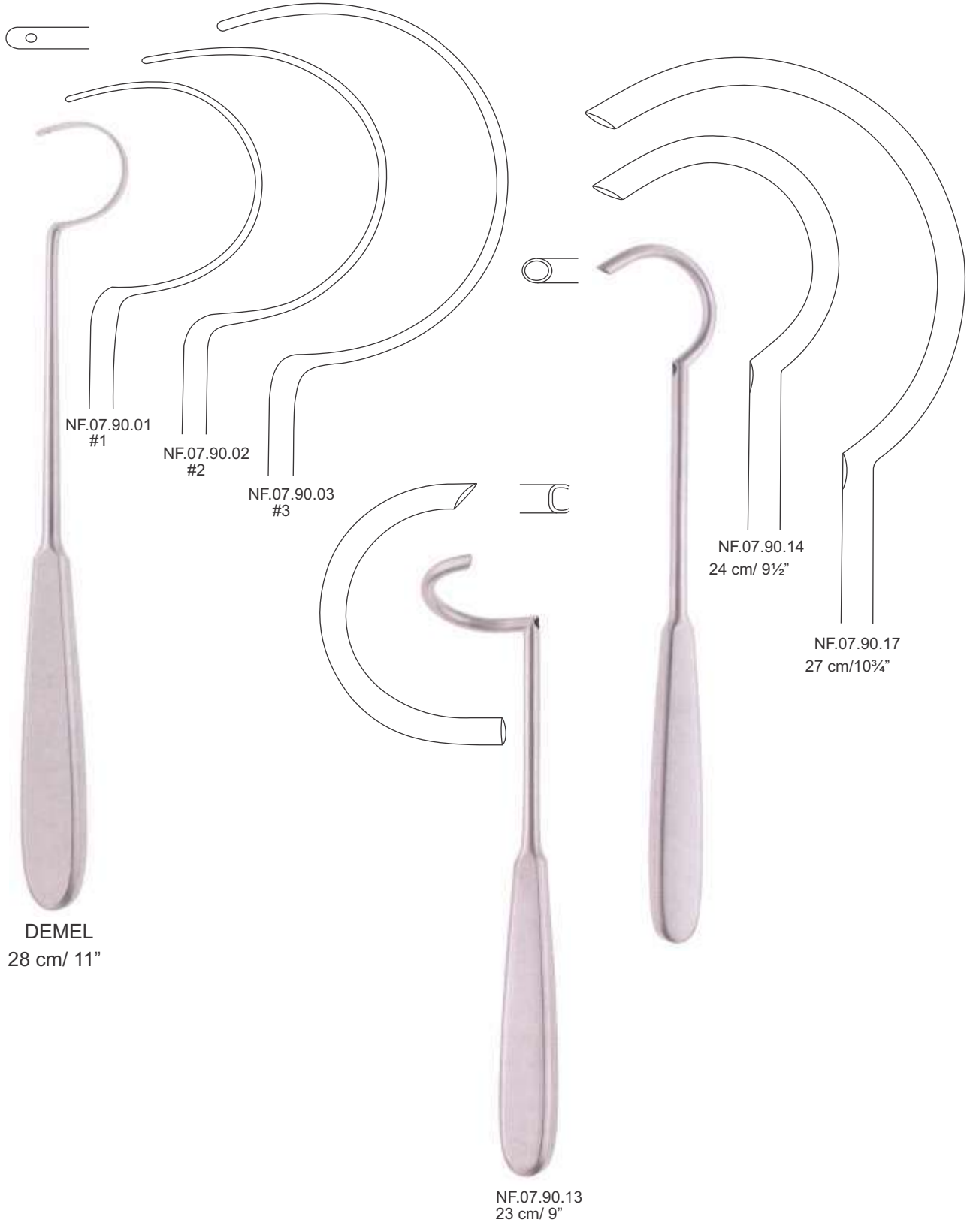

NF.07.90.01  
#1

NF.07.90.02  
#2

NF.07.90.03  
#3

NF.07.90.14  
24 cm/ 9½"

NF.07.90.17  
27 cm/10¾"

DEMEL  
28 cm/ 11"

NF.07.90.13  
23 cm/ 9"

# Orthopedic Instruments

with NOVOTEX plastic handle (autoclavable up to 134° C at 3 bar)

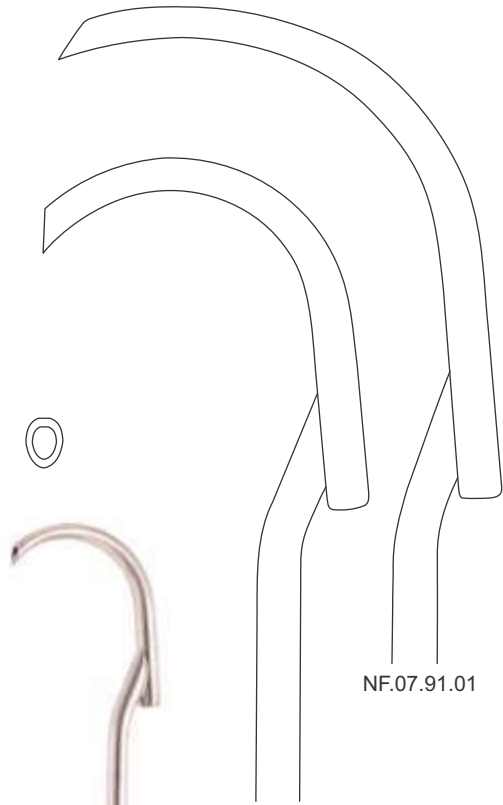

NF.07.91.01  
NF.07.91.00



21 cm/ 8¼"



LOUTE  
NF.07.90.21  
22 cm/ 8¾"



DEMEL  
NF.07.91.60  
28 cm/11"

# Orthopedic Instruments

with side cutter for wires up to max. Ø 1.6 mm

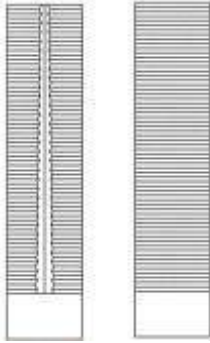

NF.07.89.17  
18 cm / 7 1/8"

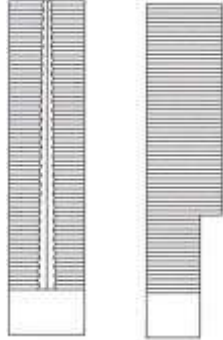

NF.07.89.118  
18.5 cm / 7 1/4"

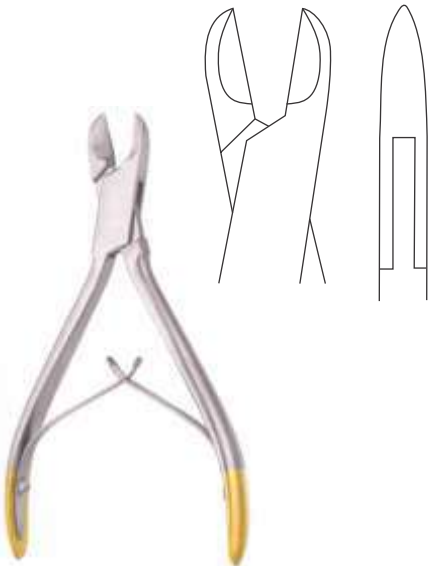

NF.07.91.11  
12 cm / 4 3/4"  
"TC"  
hard wire max. 0.6 mm  
soft wire max. 1.0 mm

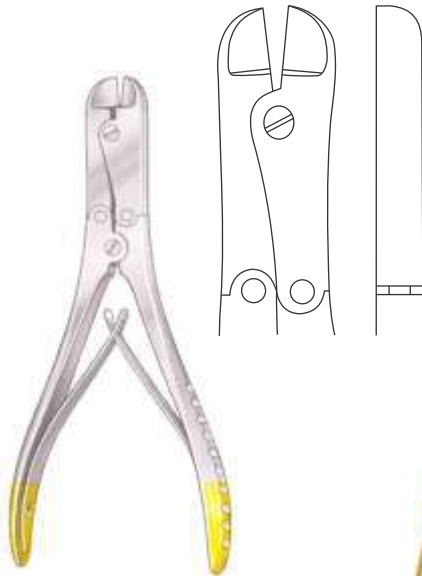

NF.07.91.13  
13 cm / 5 1/8"  
"TC"  
hard wire max. 1.2 mm  
soft wire max. 1.6 mm



NF.07.91.15  
15 cm / 6"  
"TC"  
hard wire max. 1.5 mm  
soft wire max. 2.0 mm

# Orthopedic Instruments



NF.07.92.16  
16 cm / 6 1/4"  
hard wire max. 1.5 mm  
soft wire max. 2.0 mm



NF.07.93.73  
21 cm / 8 1/4"  
"TC"  
hard wire max. 2.5 mm



NF.07.93.47  
18.5 cm - 7 1/4"  
hard wire max. 1.6 mm



NF.07.93.53  
23 cm / 9"  
hard wire max. 2.5 mm



NF.07.94.18  
19 cm / 7 1/2"  
hard wire max. 1.5 mm  
soft wire max. 2.0 mm

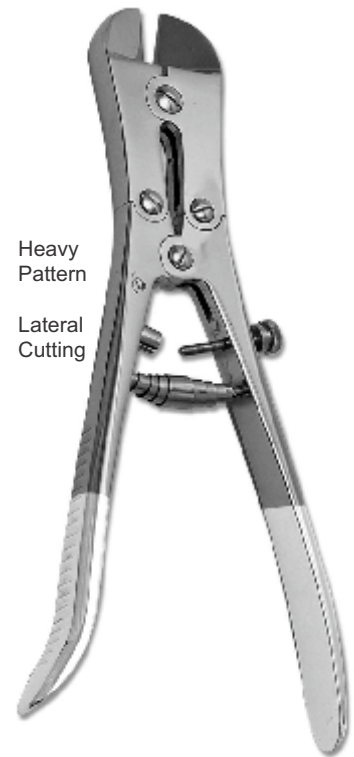
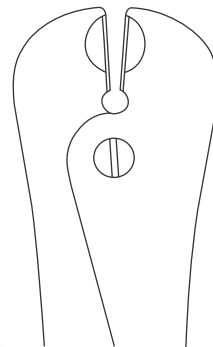

Heavy  
Pattern  
Lateral  
Cutting

NF.07.95.54  
24 cm / 9 1/2"  
"TC"

# Orthopedic Instruments



NF.07.96.17  
17.5 cm/ 7"  
"TC"

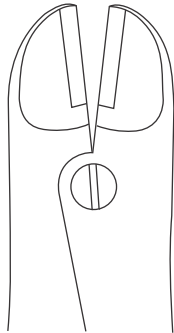

NF.07.98.22  
22 cm/ 8 3/4"  
"TC"

For Hard Wires  
upto  $\varnothing$  2.5 mm



HARMS  
NF.07.98.55  
18 cm/ 7 1/8"  
"TC"

Vertebral cutting forceps



NF.07.98.60  
18 cm/ 7 1/8"  
"TC"  
hard wire max.  $\varnothing$  1.6 mm  
soft wire max.  $\varnothing$  2.0 mm

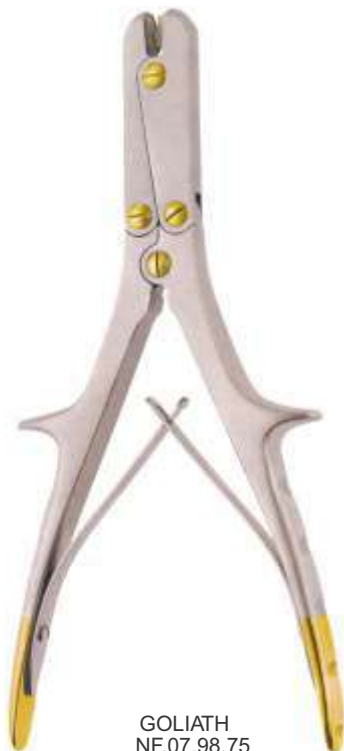

GOLIATH  
NF.07.98.75  
25 cm/ 10"  
"TC"  
hard wire max.  $\varnothing$  3.0 mm



Plastic inserts hold wire piece  
after being cut.

# Orthopedic Instruments



Easy Cut  
NF.07.98.85  
20 cm/ 8"  
"TC"  
hard wires max. Ø1.8 mm



Plastic inserts hold wire piece  
after being cut.



NF.07.99.80  
45 cm/ 17¾"



NF.07.99.79  
26 cm/ 10¼"  
hard wires max. Ø3.0 mm





# Orthopedic Instruments



- NF.07.01.02 2 mm
- NF.07.01.03 3 mm
- NF.07.01.04 4 mm
- NF.07.01.06 6 mm
- NF.07.01.08 8 mm
- NF.07.01.10 10 mm
- NF.07.01.12 12 mm
- NF.07.01.15 15 mm

NF.07.01.90  
Set complete in canvas roll

**MINI-LAMBOTTE**  
13 cm / 5 1/8"



- NF.07.01.52 2 mm
- NF.07.01.53 3 mm
- NF.07.01.54 4 mm
- NF.07.01.56 6 mm
- NF.07.01.58 8 mm
- NF.07.01.60 10 mm
- NF.07.01.62 12 mm
- NF.07.01.65 15 mm

NF.07.01.95  
Set complete in canvas roll

**MINI-LAMBOTTE**  
17 cm / 6 3/4"



- NF.07.02.02 2 mm
- NF.07.02.04 4 mm
- NF.07.02.06 6 mm
- NF.07.02.08 8 mm
- NF.07.02.10 10 mm
- NF.07.02.12 12 mm
- NF.07.02.15 15 mm

NF.07.02.90  
Set complete in canvas roll

**HARDT-DELIMA**  
13 cm / 5 1/8"



- NF.07.02.52 2 mm
- NF.07.02.54 4 mm
- NF.07.02.56 6 mm
- NF.07.02.58 8 mm
- NF.07.02.60 10 mm
- NF.07.02.62 12 mm
- NF.07.02.65 15 mm

NF.07.02.95  
Set complete in canvas roll

**HARDT-DELIMA**  
17 cm / 6 3/4"



- NF.07.05.02 2 mm
- NF.07.05.03 3 mm
- NF.07.05.04 4 mm
- NF.07.05.05 5 mm
- NF.07.05.06 6 mm
- NF.07.05.08 8 mm

**PARTSCH**  
14 cm / 5 1/2"



- NF.07.05.52 2 mm
- NF.07.05.53 3 mm
- NF.07.05.54 4 mm
- NF.07.05.55 5 mm
- NF.07.05.56 6 mm
- NF.07.05.57 7 mm
- NF.07.05.58 8 mm

**PARTSCH**  
17 cm / 6 3/4"

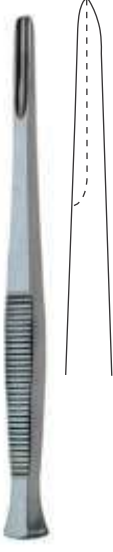

- NF.07.06.02 2 mm
- NF.07.06.03 3 mm
- NF.07.06.04 4 mm
- NF.07.06.05 5 mm
- NF.07.06.06 6 mm
- NF.07.06.08 8 mm

**PARTSCH**  
14 cm / 5 1/2"

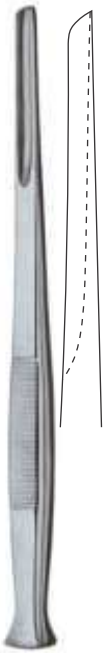

- NF.07.06.52 2 mm
- NF.07.06.53 3 mm
- NF.07.06.54 4 mm
- NF.07.06.55 5 mm
- NF.07.06.56 6 mm
- NF.07.06.57 7 mm
- NF.07.06.58 8 mm

**PARTSCH**  
17 cm / 6 3/4"

# Orthopedic Instruments



- NF.07.07.02 2 mm
- NF.07.07.04 4 mm
- NF.07.07.06 6 mm
- NF.07.07.08 8 mm
- NF.07.07.10 10 mm
- NF.07.07.12 12 mm
- NF.07.07.15 15 mm
- NF.07.07.18 18 mm
- NF.07.07.20 20 mm

**SHEEHAN**  
16 cm/ 6¼"

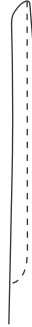

- NF.07.07.62 2 mm
- NF.07.07.63 3 mm
- NF.07.07.64 4 mm
- NF.07.07.66 6 mm

**SHEEHAN**  
16 cm/ 6¼"



- NF.07.08.04 4 mm
- NF.07.08.07 7 mm
- NF.07.08.09 9 mm
- NF.07.08.12 12 mm

**COTTLE**  
18 cm/ 7½"



- NF.07.11.10 10 mm
- NF.07.11.12 12 mm
- NF.07.11.15 15 mm
- NF.07.11.20 20 mm
- NF.07.11.25 25 mm

**STILLE**  
20 cm/ 8"



- NF.07.12.04 4 mm
- NF.07.12.06 6 mm
- NF.07.12.08 8 mm
- NF.07.12.10 10 mm
- NF.07.12.12 12 mm
- NF.07.12.15 15 mm
- NF.07.12.20 20 mm
- NF.07.12.25 25 mm

**STILLE**  
20 cm/ 8"



- NF.07.15.60 10 mm
- NF.07.15.62 12 mm
- NF.07.15.65 15 mm
- NF.07.15.70 20 mm
- NF.07.15.75 25 mm

**STILLE**  
20 cm/ 8"



- NF.07.16.06 6 mm
- NF.07.16.08 8 mm
- NF.07.16.10 10 mm
- NF.07.16.12 12 mm
- NF.07.16.15 15 mm
- NF.07.16.20 20 mm
- NF.07.16.25 25 mm

**STILLE**  
20 cm/ 8"



- NF.07.17.04 4 mm
- NF.07.17.06 6 mm
- NF.07.17.08 8 mm
- NF.07.17.10 10 mm
- NF.07.17.12 12 mm
- NF.07.17.14 14 mm

**ALEXANDER**  
18 cm/ 7½"

# Orthopedic Instruments

**ALEXANDER**  
18 cm / 7 1/8"

- NF.07.18.04 4 mm
- NF.07.18.05 5 mm
- NF.07.18.06 6 mm
- NF.07.18.07 7 mm
- NF.07.18.08 8 mm
- NF.07.18.09 9 mm
- NF.07.18.10 10 mm
- NF.07.18.11 11 mm
- NF.07.18.12 12 mm
- NF.07.18.14 14 mm

**STILLE**  
16 cm / 6 1/4"

- NF.07.19.06 6 mm
- NF.07.19.08 8 mm
- NF.07.19.10 10 mm
- NF.07.19.12 12 mm
- NF.07.19.15 15 mm

**STILLE**  
16 cm / 6 1/4"

- NF.07.20.04 4 mm
- NF.07.20.06 6 mm
- NF.07.20.08 8 mm
- NF.07.20.10 10 mm
- NF.07.20.12 12 mm
- NF.07.20.15 15 mm

**FREER**  
17 cm / 6 3/4"

- NF.07.21.11
- NF.07.21.10
- NF.07.21.19

**WEST**  
NF.07.22.12  
16 cm / 6 1/4"

**WEST**  
16 cm / 6 1/4"

- NF.07.22.14
- NF.07.22.15

**Freer (left)**  
14 cm / 5 1/2"

- NF.07.23.04 4 mm
- NF.07.23.06 6 mm
- NF.07.23.08 8 mm
- NF.07.23.10 10 mm
- NF.07.23.12 12 mm
- NF.07.23.14 14 mm
- NF.07.23.16 16 mm

**Freer (right)**  
14 cm / 5 1/2"

- NF.07.24.03 3 mm
- NF.07.24.04 4 mm
- NF.07.24.05 5 mm
- NF.07.24.06 6 mm
- NF.07.24.08 8 mm
- NF.07.24.10 10 mm
- NF.07.24.12 12 mm
- NF.07.24.14 14 mm
- NF.07.24.16 16 mm

# Orthopedic Instruments



- NF.08.25.03 3 mm
- NF.08.25.04 4 mm
- NF.08.25.05 5 mm
- NF.08.25.06 6 mm
- NF.08.25.08 8 mm
- NF.08.25.10 10 mm
- NF.08.25.12 12 mm
- NF.08.25.14 14 mm
- NF.08.25.16 16 mm

14 cm/ 5½"



- NF.08.26.03 Ø 3 mm
- NF.08.26.05 Ø 5 mm
- NF.08.26.07 Ø 7 mm
- NF.08.26.09 Ø 9 mm

16 cm/ 6¼"

Bone tamper



**HIBBS**  
24 cm/ 9½"

- NF.08.30.06 6 mm
- NF.08.30.12 12 mm
- NF.08.30.13 13 mm
- NF.08.30.19 19 mm
- NF.08.30.20 20 mm
- NF.08.30.25 25 mm
- NF.08.30.30 30 mm
- NF.08.30.32 32 mm
- NF.08.30.40 40 mm



**HIBBS**  
24 cm/ 9½"

- NF.08.31.06 6 mm
- NF.08.31.12 12 mm
- NF.08.31.13 13 mm
- NF.08.31.19 19 mm
- NF.08.31.20 20 mm
- NF.08.31.25 25 mm
- NF.08.31.30 30 mm
- NF.08.31.32 32 mm
- NF.08.31.40 40 mm



**HIBBS**  
24 cm/ 9½"

- NF.08.32.06 6 mm
- NF.08.32.12 12 mm
- NF.08.32.20 20 mm
- NF.08.32.25 25 mm
- NF.08.32.30 30 mm
- NF.08.32.32 32 mm
- NF.08.32.40 40 mm

# Orthopedic Instruments



**HIBBS**  
24 cm/ 9½"

- NF.08.33.06 6 mm
- NF.08.33.12 12 mm
- NF.08.33.20 20 mm
- NF.08.33.25 25 mm
- NF.08.33.30 30 mm
- NF.08.33.40 40 mm



**HIBBS**  
24 cm/ 9½"

- NF.08.34.06 6 mm
- NF.08.34.12 12 mm
- NF.08.34.20 20 mm
- NF.08.34.25 25 mm
- NF.08.34.30 30 mm
- NF.08.34.40 40 mm

With Novotex Plastic Handle  
(autoclavable Up To 134° C At 3 Bar)



**BRUNINGS**  
16 cm/ 6¼"

- NF.08.35.04 4 mm
- NF.08.35.06 6 mm
- NF.08.35.08 8 mm
- NF.08.35.10 10 mm



**BRUNINGS**  
16 cm/ 6¼"

- NF.08.35.34 4 mm
- NF.08.35.36 6 mm
- NF.08.35.38 8 mm
- NF.08.35.40 10 mm



**LEXER**  
25 cm/ 10"

- NF.08.36.55 5 mm
- NF.08.36.60 10 mm
- NF.08.36.65 15 mm



**LEXER**  
25 cm/ 10"

- NF.08.36.75 5 mm
- NF.08.36.80 10 mm
- NF.08.36.85 15 mm

# Orthopedic Instruments

With Novotex Plastic Handle (autoclavable Up To 134° C At 3 Bar)



**COBB**  
28 cm/ 11"



NF.08.36.91



NF.08.36.92



NF.08.36.93

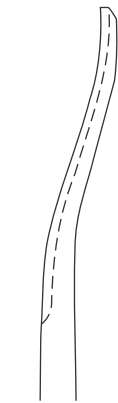

NF.08.36.94



**SMITH-PETERSEN**  
20 cm/ 8"

- NF.08.38.06 6 mm
- NF.08.38.09 9 mm
- NF.08.38.12 12 mm
- NF.08.38.15 15 mm
- NF.08.38.20 20 mm
- NF.08.38.25 25 mm
- NF.08.38.30 30 mm



**SMITH-PETERSEN**  
20 cm/ 8"

- NF.08.38.56 6 mm
- NF.08.38.59 9 mm
- NF.08.38.62 12 mm
- NF.08.38.65 15 mm
- NF.08.38.70 20 mm
- NF.08.38.75 25 mm
- NF.08.38.80 30 mm



NF.08.37.11  
3 mm



NF.08.37.12  
3.5 mm



Bone tamper

**PASSOW**  
12 cm/ 4¾"

# Orthopedic Instruments

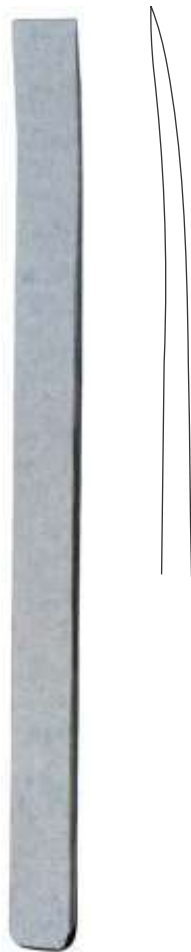
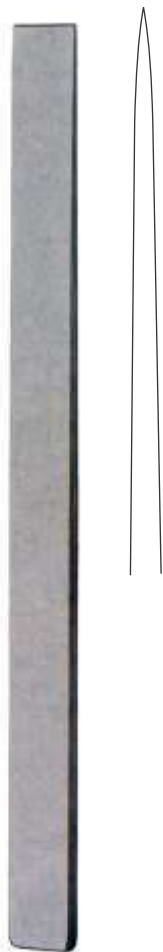

**LAMBOTTE**  
24 cm/ 9½"

NF.08.39.04	4 mm
NF.08.39.06	6 mm
NF.08.39.08	8 mm
NF.08.39.10	10 mm
NF.08.39.12	12 mm
NF.08.39.15	15 mm
NF.08.39.18	18 mm
NF.08.39.20	20 mm
NF.08.39.25	25 mm
NF.08.39.30	30 mm
NF.08.39.40	40 mm
NF.08.39.44	44 mm
NF.08.39.50	50 mm

**LAMBOTTE**  
24 cm/ 9½"

NF.08.39.54	4 mm
NF.08.39.56	6 mm
NF.08.39.58	8 mm
NF.08.39.60	10 mm
NF.08.39.62	12 mm
NF.08.39.65	15 mm
NF.08.39.70	20 mm
NF.08.39.75	25 mm
NF.08.39.80	30 mm
NF.08.39.90	40 mm
NF.08.39.94	44 mm
NF.08.39.99	50 mm

**SMITH-PETERSEN**  
20 cm/ 8"

NF.08.40.06	6 mm
NF.08.40.09	9 mm
NF.08.40.12	12 mm
NF.08.40.15	15 mm
NF.08.40.20	20 mm
NF.08.40.25	25 mm
NF.08.40.30	30 mm

**SMITH-PETERSEN**  
20 cm/ 8"

NF.08.40.56	6 mm
NF.08.40.59	9 mm
NF.08.40.62	12 mm
NF.08.40.65	15 mm
NF.08.40.70	20 mm
NF.08.40.75	25 mm
NF.08.40.80	30 mm



# Orthopedic Instruments

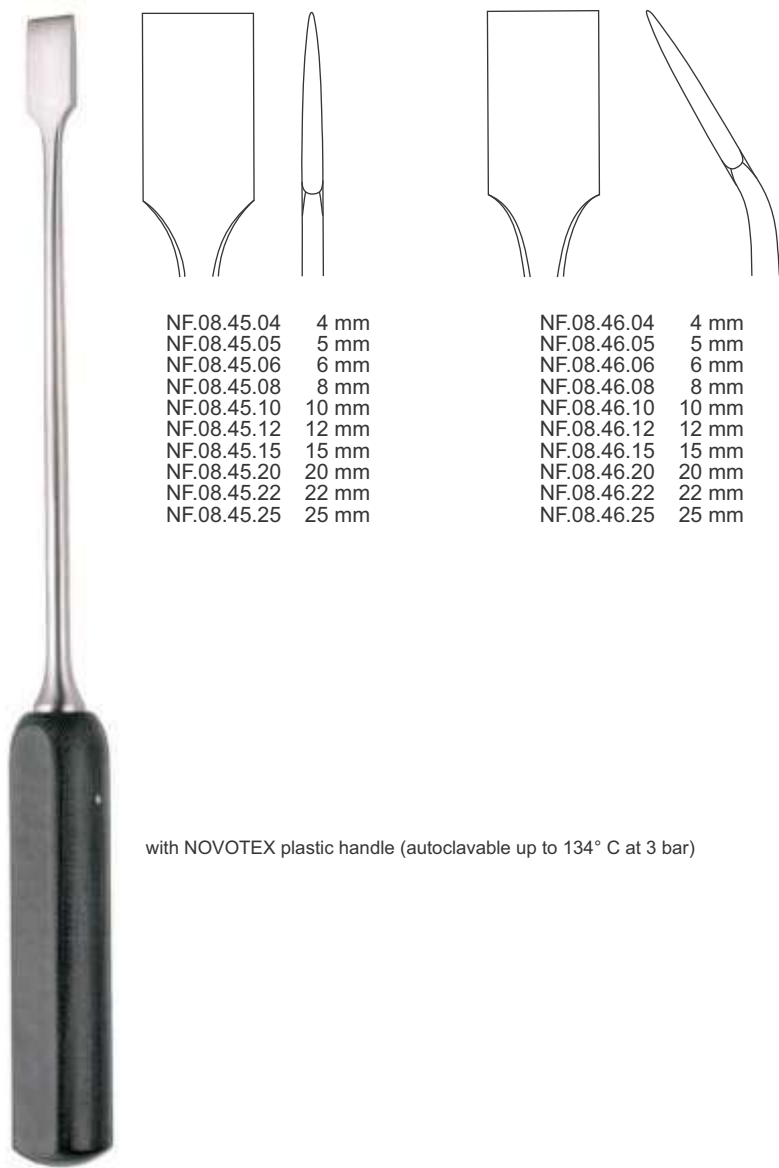

NF.08.45.04	4 mm
NF.08.45.05	5 mm
NF.08.45.06	6 mm
NF.08.45.08	8 mm
NF.08.45.10	10 mm
NF.08.45.12	12 mm
NF.08.45.15	15 mm
NF.08.45.20	20 mm
NF.08.45.22	22 mm
NF.08.45.25	25 mm

NF.08.46.04	4 mm
NF.08.46.05	5 mm
NF.08.46.06	6 mm
NF.08.46.08	8 mm
NF.08.46.10	10 mm
NF.08.46.12	12 mm
NF.08.46.15	15 mm
NF.08.46.20	20 mm
NF.08.46.22	22 mm
NF.08.46.25	25 mm

with NOVOTEX plastic handle (autoclavable up to 134° C at 3 bar)

**DAHMEN**  
30 cm/ 11¾"

# Orthopedic Instruments



**DAHMEN**  
30 cm / 11¾"

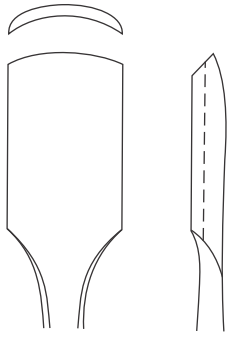

- NF.08.47.04 4 mm
- NF.08.47.05 5 mm
- NF.08.47.06 6 mm
- NF.08.47.08 8 mm
- NF.08.47.10 10 mm
- NF.08.47.12 12 mm
- NF.08.47.15 15 mm
- NF.08.47.20 20 mm
- NF.08.47.22 22 mm
- NF.08.47.25 25 mm

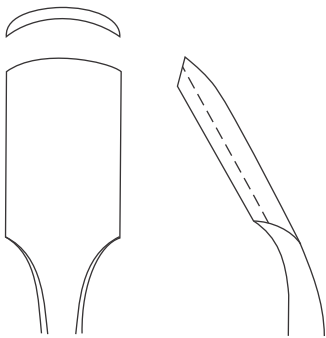

- NF.08.48.04 4 mm
- NF.08.48.05 5 mm
- NF.08.48.06 6 mm
- NF.08.48.08 8 mm
- NF.08.48.10 10 mm
- NF.08.48.12 12 mm
- NF.08.48.15 15 mm
- NF.08.48.20 20 mm
- NF.08.48.22 22 mm
- NF.08.48.25 25 mm

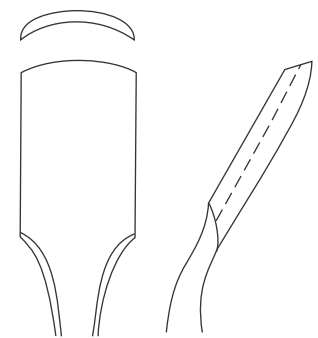

- NF.08.49.04 4 mm
- NF.08.49.05 5 mm
- NF.08.49.06 6 mm
- NF.08.49.08 8 mm
- NF.08.49.10 10 mm
- NF.08.49.12 12 mm
- NF.08.49.15 15 mm
- NF.08.49.20 20 mm
- NF.08.49.22 22 mm
- NF.08.49.25 25 mm

with NOVOTEX plastic handle (autoclavable up to 134° C at 3 bar)

# Orthopedic Instruments



- NF.08.54.02 2 mm
- NF.08.54.04 4 mm
- NF.08.54.06 6 mm
- NF.08.54.08 8 mm
- NF.08.54.10 10 mm
- NF.08.54.12 12 mm
- NF.08.54.15 15 mm
- NF.08.54.20 20 mm

**MINI-LEXER**  
18 cm / 7 1/8"



- NF.08.56.02 2 mm
- NF.08.56.04 4 mm
- NF.08.56.06 6 mm
- NF.08.56.08 8 mm
- NF.08.56.10 10 mm
- NF.08.56.12 12 mm
- NF.08.56.15 15 mm
- NF.08.56.20 20 mm

**MINI-LEXER**  
18 cm / 7 1/8"



- NF.08.58.05 5 mm
- NF.08.58.07 7 mm
- NF.08.58.10 10 mm
- NF.08.58.12 12mm
- NF.08.58.15 15 mm
- NF.08.58.20 20 mm
- NF.08.58.25 25 mm
- NF.08.58.30 30 mm

**LEXER**  
22 cm / 8 3/4"



- NF.08.60.05 5 mm
- NF.08.60.07 7 mm
- NF.08.60.10 10 mm
- NF.08.60.12 12mm
- NF.08.60.15 15 mm
- NF.08.60.20 20 mm
- NF.08.60.25 25 mm
- NF.08.60.30 30 mm

**LEXER**  
22 cm / 8 3/4"



**SMILLIE**  
17 cm - 6 3/4"

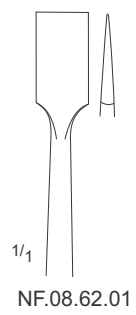

NF.08.62.01

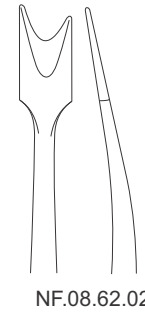

NF.08.62.02

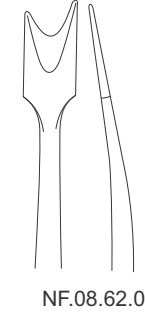

NF.08.62.03

# Orthopedic Instruments

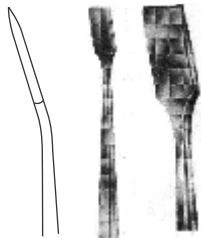

**SMILLIE**  
NF.08.62.04  
17 cm / 6<sup>3</sup>/<sub>4</sub>"

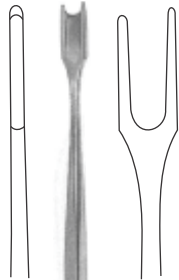

**SMILLIE**  
NF.08.62.00  
17 cm / 6<sup>3</sup>/<sub>4</sub>"



**NEFF**  
NF.08.63.22  
22 cm / 8<sup>3</sup>/<sub>4</sub>"

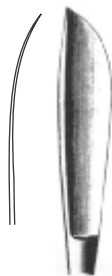

**NEFF**  
NF.08.63.23  
22 cm / 8<sup>3</sup>/<sub>4</sub>"



**SALENIUS**  
NF.08.63.32  
22.5 cm / 9"

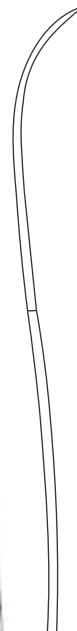

**SALENIUS**  
NF.08.63.33  
22.5 cm / 9"



# Orthopedic Instruments

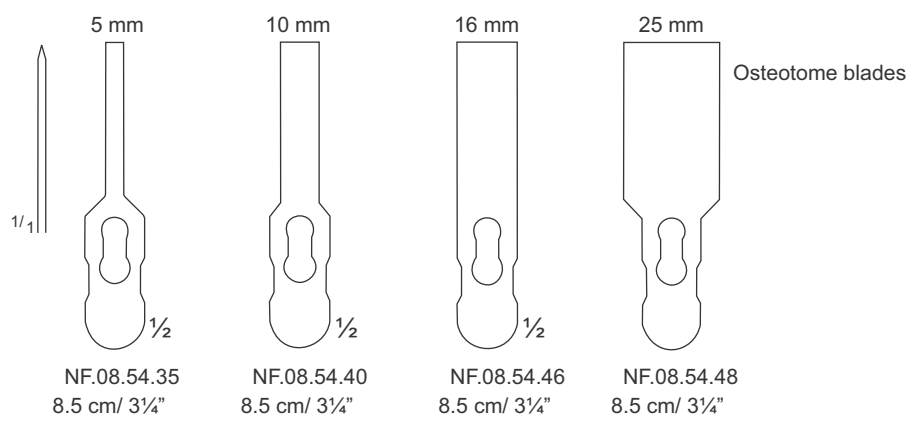
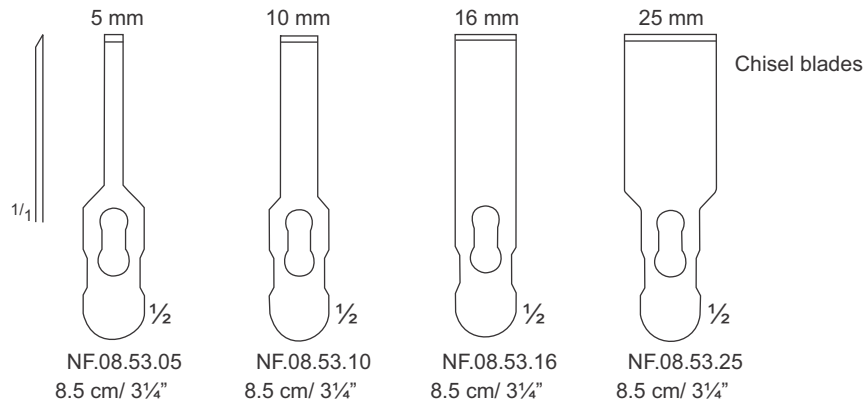

NF.08.53.02  
9 cm / 3 1/2"  
Wrench

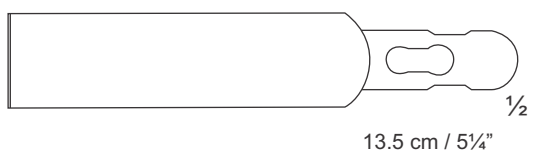
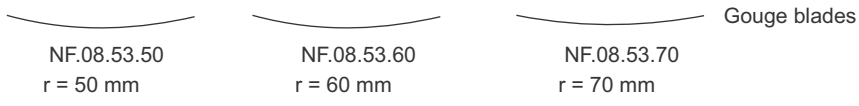

# Orthopedic Instruments



# Orthopedic Instruments



NF.08.01.10  
# 0 - Ø 2 mm



NF.08.01.11  
# 1 - Ø 2.5 mm



NF.08.01.12  
# 2 - Ø 3 mm



NF.08.01.13  
# 3 - Ø 3.5 mm



NF.08.01.14  
# 4 - Ø 5 mm



**MEYERHOEFER**  
14 cm / 5½"



NF.08.02.01  
15 cm / 6"



NF.08.02.02  
15 cm / 6"



NF.08.02.03  
15 cm / 6"



**BRUNS**  
17 cm / 6¾"

NF.08.03.24  
# 000



NF.08.03.33  
# 000



NF.08.03.42  
# 000



NF.08.03.50  
# 0



NF.08.03.51  
# 1



NF.08.03.52  
# 2



NF.08.03.53  
# 3



NF.08.03.54  
# 4



NF.08.03.55  
# 5



NF.08.03.56  
# 6



# Orthopedic Instruments



**BUCK**  
14.5 cm / 5 3/4"



NF.08.04.01  
# 1



NF.08.04.02  
# 2



NF.08.04.03  
# 3



NF.08.04.04  
# 4



NF.08.04.05  
# 5



**WILLIGER**  
17 cm / 6 3/4"



NF.08.05.01  
# 1 - 4 mm



NF.08.05.51  
# 1 - 3.5 mm



NF.08.05.02  
# 2 - 5 mm



NF.08.05.52  
# 2 - 5.5 mm

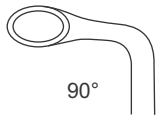

90°



**SIEBENMANN**  
NF.08.05.65  
16 cm / 6 1/4"

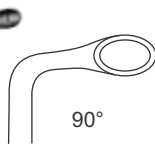

90°



**SIEBENMANN**  
NF.08.05.66  
16 cm / 6 1/4"



NF.08.05.72  
# 00



NF.08.05.80  
# 0



NF.08.05.81  
# 1



NF.08.05.82  
# 2



**DAUBENSPECK**  
20 cm / 8"



# Orthopedic Instruments

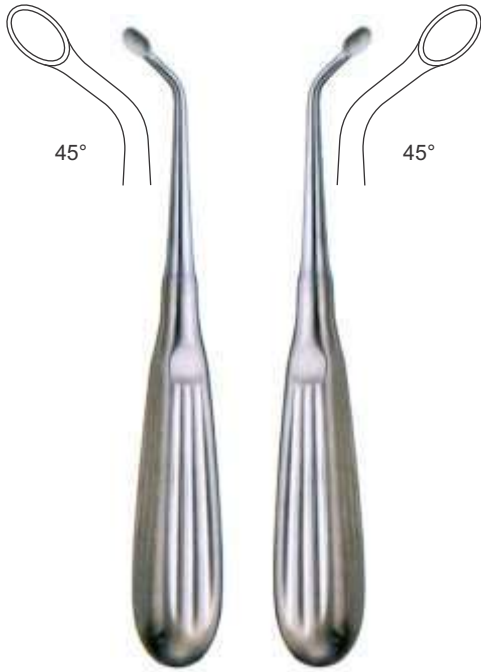

UFFENORDE  
NF.08.05.87  
17 cm / 6¾"

UFFENORDE  
NF.08.05.88  
17 cm / 6¾"



KERPEL  
15 cm / 6"



KERPEL  
15 cm / 6"



KERPEL  
15 cm / 6"



19.5 cm / 7¾"

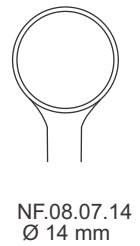
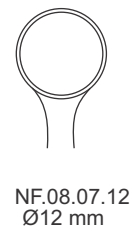
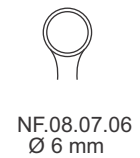
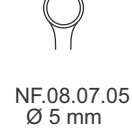
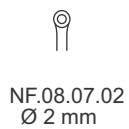

# Orthopedic Instruments



20 cm/ 8"



NF.08.08.02  
2 mm



NF.08.08.03  
3 mm



NF.08.08.04  
4 mm



NF.08.08.05  
5 mm



NF.08.08.06  
6 mm



NF.08.08.07  
7 mm



NF.08.08.08  
8 mm



NF.08.08.10  
10 mm



NF.08.08.12  
12 mm

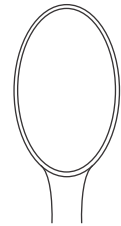

NF.08.08.14  
14 mm



BRUNS  
23 cm/ 9"



NF.08.09.24  
# 0000



NF.08.09.33  
# 000



NF.08.09.42  
# 00



NF.08.09.50  
# 0



NF.08.09.51  
# 1



NF.08.09.52  
# 2



NF.08.09.53  
# 3



NF.08.09.54  
# 4



NF.08.09.55  
# 5



NF.08.09.56  
# 6

# Orthopedic Instruments



NF.08.10.64  
# 0000



NF.08.10.73  
# 000



NF.08.10.82  
# 00



NF.08.10.90  
# 0



NF.08.10.91  
# 1



NF.08.10.92  
# 2



NF.08.10.93  
# 3



NF.08.10.94  
# 4



NF.08.10.95  
# 5



NF.08.10.96  
# 6

with NOVOTEX plastic handle (autoclavable up to 134° C at 3 bar)

**BRUNS**  
27 cm / 10 3/4"



NF.08.11.24  
# 0000



NF.08.11.33  
# 000



NF.08.11.42  
# 00



NF.08.11.50  
# 0



NF.08.11.51  
# 1



NF.08.11.52  
# 2



NF.08.11.53  
# 3



NF.08.11.54  
# 4



NF.08.11.55  
# 5

**SPRATT**  
18 cm / 7 1/8"



NF.08.12.06  
# 000000



NF.08.12.15  
# 00000



NF.08.12.24  
# 0000



NF.08.12.33  
# 000



NF.08.12.42  
# 00



NF.08.12.50  
# 0



NF.08.12.51  
# 1



NF.08.12.52  
# 2

**LEMPERT**  
21 cm / 8 1/4"

# Orthopedic Instruments



4 mm  
NF.08.13.51 # 1

5 mm  
NF.08.13.52 # 2

6 mm  
NF.08.13.53 # 3



NF.08.14.24 # 0000

NF.08.14.33 # 000

NF.08.14.42 # 00

NF.08.14.50 # 0

NF.08.14.51 # 1

NF.08.14.52 # 2

NF.08.14.53 # 3

NF.08.14.54 # 4

NF.08.14.55 # 5

NF.08.14.56 # 6



NF.08.15.33 # 000

NF.08.15.42 # 00

NF.08.15.50 # 0

NF.08.15.51 # 1

NF.08.15.52 # 2

NF.08.15.53 # 3

NF.08.15.54 # 4

# Orthopedic Instruments



VOLKMANN  
23 cm / 9"



NF.08.16.24  
# 0000



NF.08.16.33  
# 000



NF.08.16.42  
# 00



NF.08.16.50  
# 0



NF.08.16.51  
# 1



NF.08.16.52  
# 2



NF.08.16.53  
# 3



NF.08.16.54  
# 4



NF.08.16.55  
# 5



NF.08.16.56  
# 6



VOLKMANN  
23 cm / 9"



NF.08.17.24  
# 0000



NF.08.17.33  
# 000



NF.08.17.42  
# 00



NF.08.17.50  
# 0



NF.08.17.51  
# 1



NF.08.17.52  
# 2



NF.08.17.53  
# 3



NF.08.17.54  
# 4



NF.08.17.55  
# 5

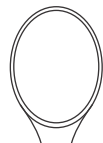

NF.08.17.56  
# 6

# Orthopedic Instruments

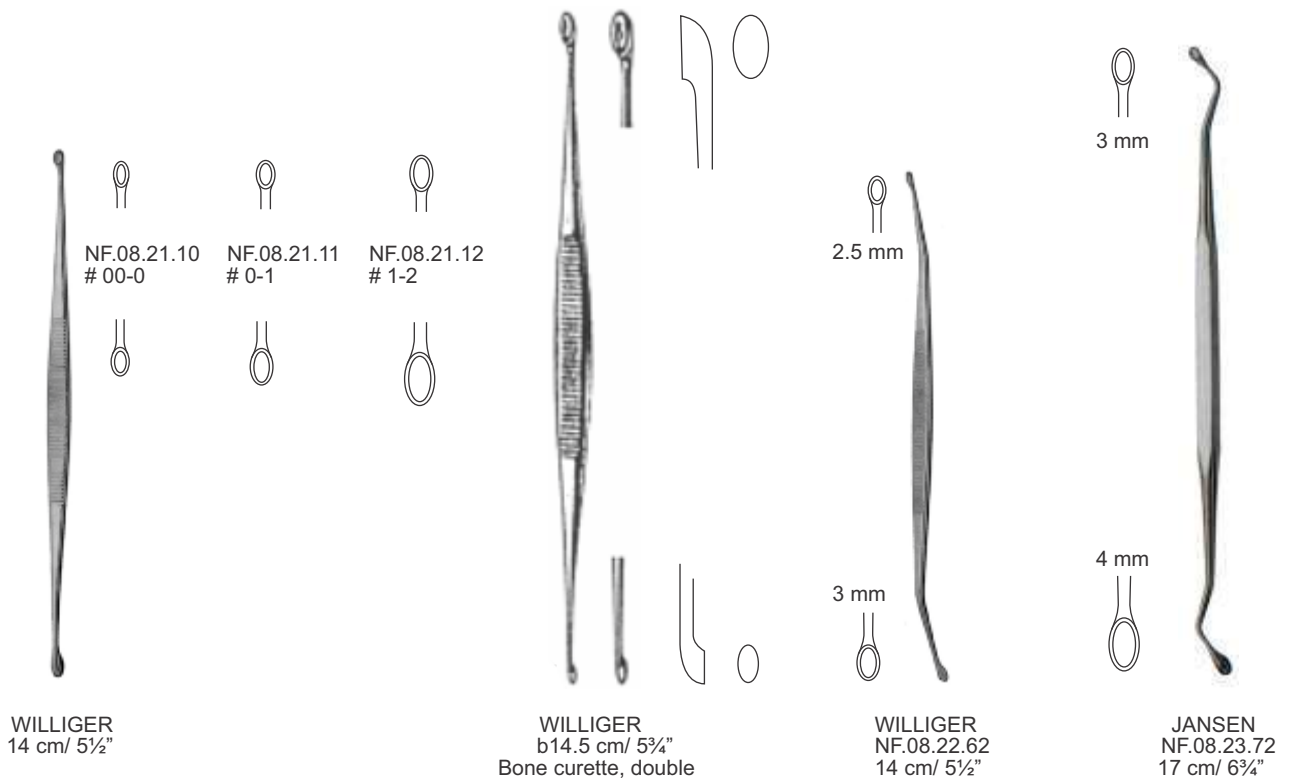
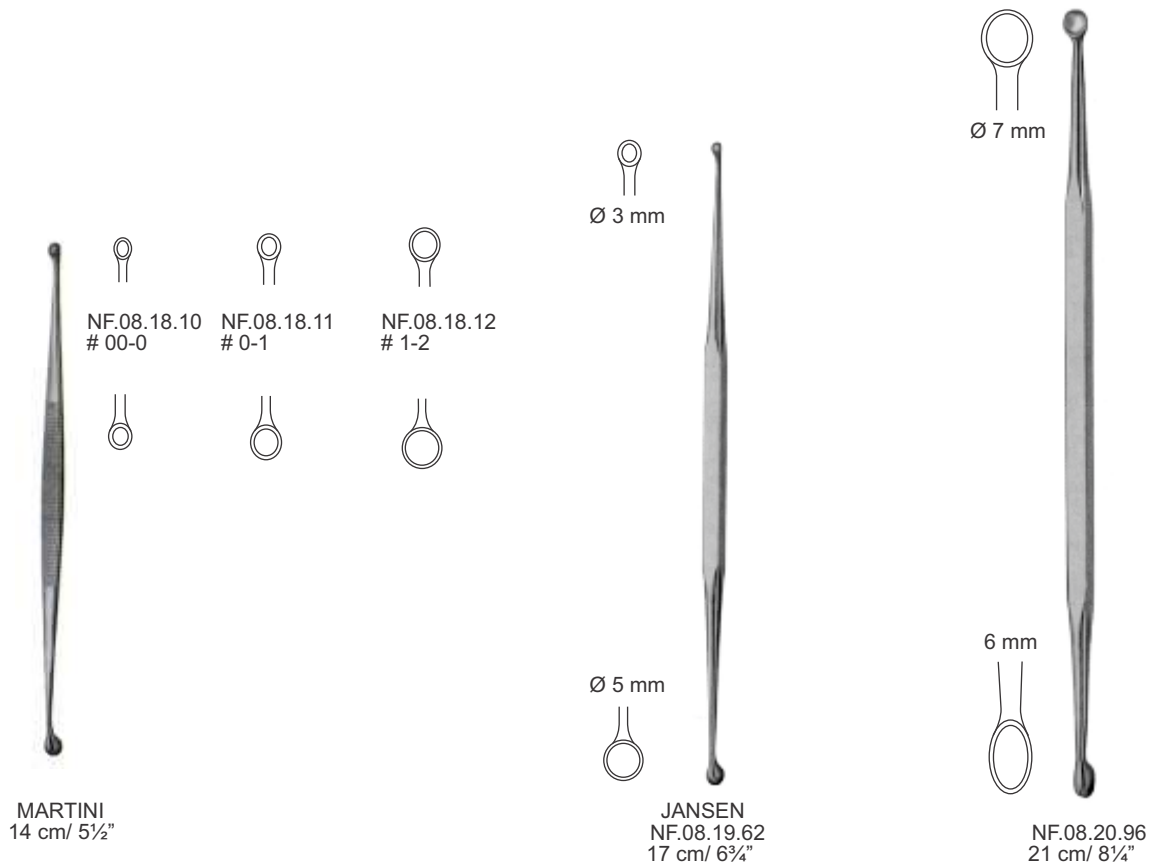

# Orthopedic Instruments



**HEMINGWAY**  
18 cm / 7 1/8"

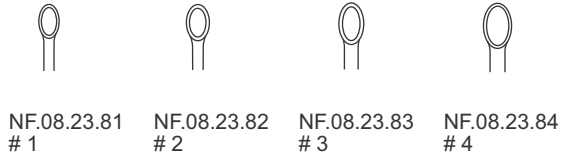

NF.08.23.81 # 1    NF.08.23.82 # 2    NF.08.23.83 # 3    NF.08.23.84 # 4



**VOLKMANN**  
NF.08.24.13 13 cm / 5 1/8"  
NF.08.24.14 14.5 cm / 5 3/4"



**VOLKMANN**  
NF.08.24.17 17 cm / 6 3/4"  
NF.08.24.20 20 cm / 8"



**VOLKMANN**  
22 cm / 8 3/4"

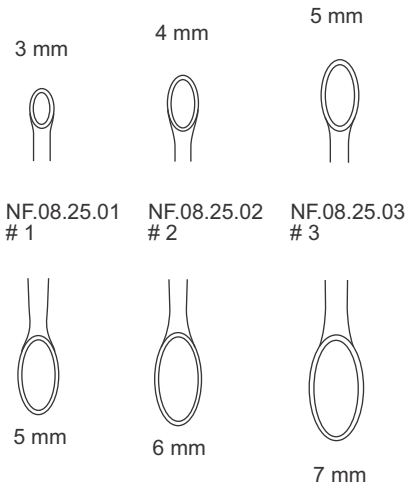

NF.08.25.01 # 1    NF.08.25.02 # 2    NF.08.25.03 # 3

# Orthopedic Instruments





# Orthopedic Instruments

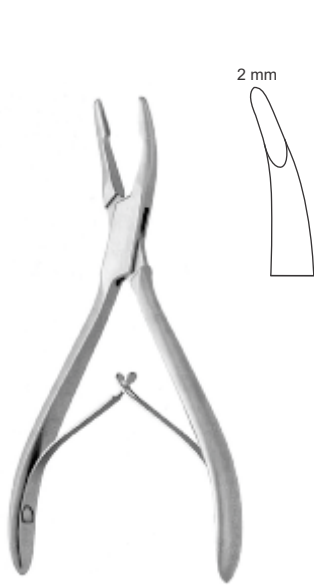

MINI-FRIEDMAN  
NF.08.01.12  
12 cm / 4¾"



FRIEDMANN  
NF.08.01.14  
14 cm / 5½"

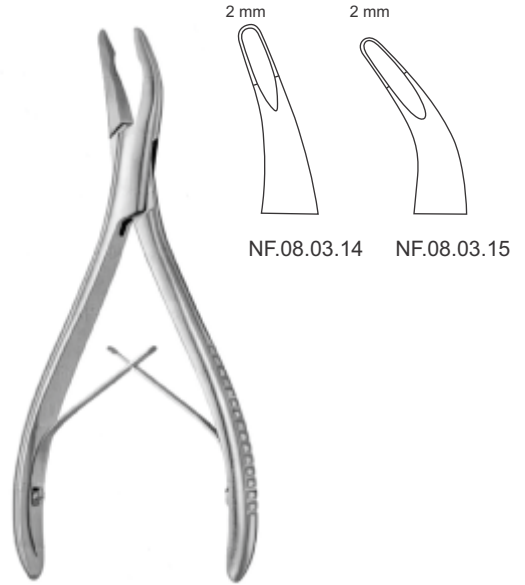

14 cm / 5½"

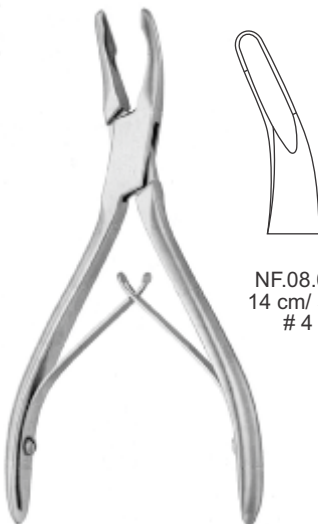

MEAD



NF.08.04.14  
14 cm / 5½"  
# 4



NF.08.04.16  
17 cm / 6¾"  
# 4A



NF.08.04.17  
17 cm / 6¾"



NF.08.05.18

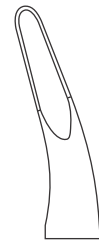

NF.08.05.19



JANSEN  
17 cm / 6¾"

# Orthopedic Instruments

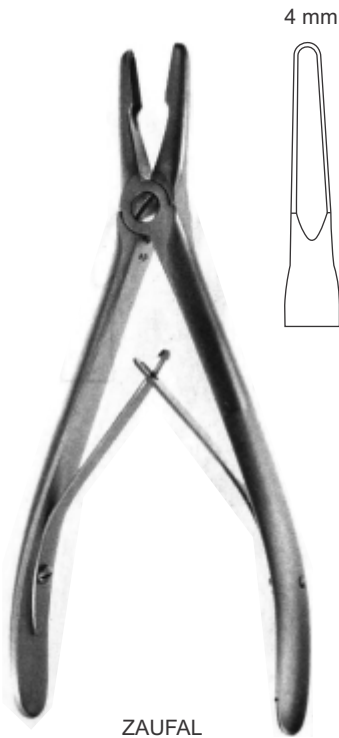

**ZAUFAL**  
NF.08.06.68  
18 cm / 7 1/8"



**BANE**  
NF.08.07.18  
18 cm / 7 1/8"



**HARTMANN**



NF.08.08.53  
16 cm / 6 1/4"

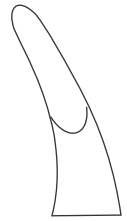

NF.08.08.56  
19 cm / 7 1/2"



**OLIVECRONA**  
NF.08.09.69  
20 cm / 8"



**MEAD**



NF.08.10.14  
14 cm / 5 1/2"  
# 1



NF.08.10.17  
17 cm / 6 3/4"  
# 1A



**MEAD**

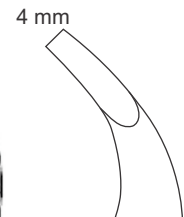

NF.08.11.87  
17 cm / 6 3/4"

# Orthopedic Instruments



**SHELL**  
NF.08.12.97  
17 cm / 6¾"



**BLUMENTHAL**  
16 cm / 6¼"

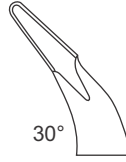

30°

NF.08.13.30

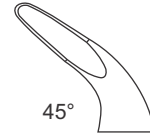

45°

NF.08.14.45

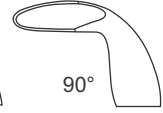

90°

NF.08.15.90



**FISCH**

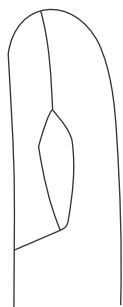
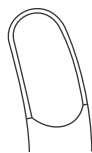

NF.08.16.12



NF.08.16.13



**ADSON**  
NF.08.17.21  
21 cm / 8¼"



# Orthopedic Instruments

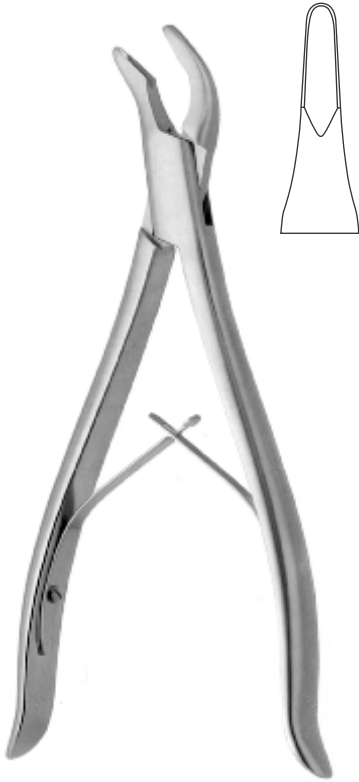

**BACON**  
NF.08.18.70  
20 cm / 8"



**BEYER**  
17 cm / 6¾"



NF.08.19.02

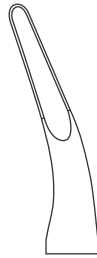

NF.08.19.03



**LUER**  
15 cm / 6"



NF.08.20.15



NF.08.21.35



**LUER**  
18 cm / 7½"

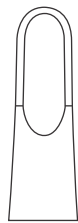

NF.08.22.17

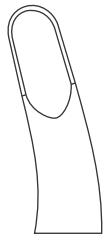

NF.08.22.18



**LUER**  
18 cm / 7½"



NF.08.23.18

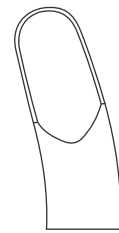

NF.08.24.18

# Orthopedic Instruments



**KLEINERT-KUTZ**  
14 cm / 5½"



NF.08.25.13



NF.08.25.1



**STELLBRINK**  
17 cm / 6¾"



NF.08.26.17



NF.08.26.18



NF.08.26.35



NF.08.26.33



**RUSKIN**  
18 cm / 7⅛"



NF.08.26.45



NF.08.26.46



**SMITH-PETERSEN**  
23 cm / 9"



NF.08.27.24

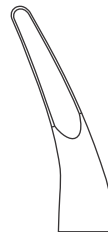

NF.08.28.24

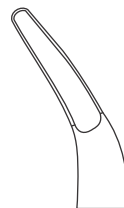

NF.08.29.24



**RUSKIN**  
24 cm / 9½"



**RUSKIN**  
NF.08.35.28  
18 cm / 7 1/8"

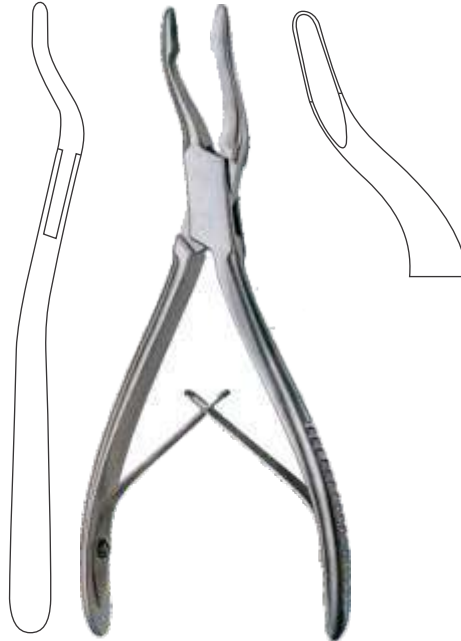

**JANSEN**  
NF.08.36.17  
17 cm / 6 3/4"

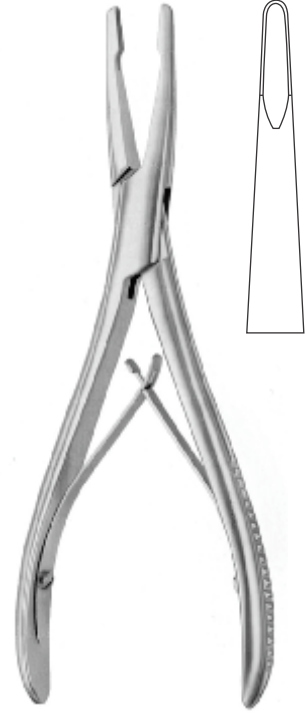

**DEFOURMENTEL**  
NF.08.37.19  
19 cm / 7 1/2"



NF.08.39.19

NF.08.38.19

**LEMPERT**  
19 cm / 7 1/2"



**GEIGER**  
NF.08.40.15  
15 cm / 6"



**MARQUARDT**  
NF.08.41.20  
20 cm / 8"

# Orthopedic Instruments



**PEIPER-BEYER**  
NF.08.42.18  
4 mm, 18 cm / 7 1/8"



**STILLE-LEKSELL**  
NF.08.43.23  
23 cm / 9"



**STILLE-LUER**  
23 cm / 9"

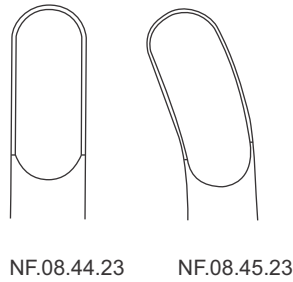

NF.08.44.23

NF.08.45.23



**SAUERBRUCH-STILLE**  
26 cm / 10 1/4"

# Orthopedic Instruments



**SAUERBRUCH-STILLE**  
26 cm/ 10¼"

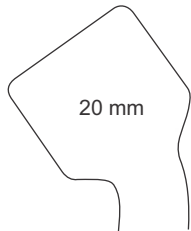

20 mm

NF.08.47.26



**STILLE**  
NF.08.48.23  
23 cm/ 9"

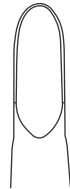

**LEKSELL**  
23 cm/ 9"

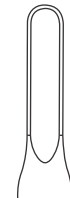

NF.08.49.05

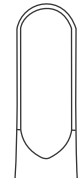

NF.08.49.08

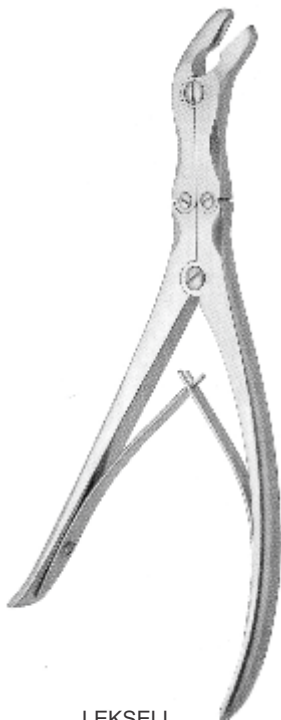

**LEKSELL**  
23 cm/ 9"

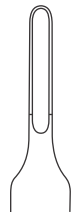

NF.08.50.03

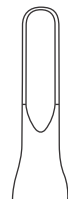

NF.08.50.05



NF.08.50.08



**ECHLIN**  
23 cm/ 9"

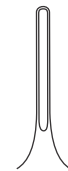

NF.08.51.02

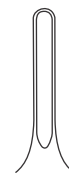

NF.08.51.03

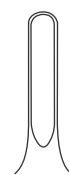

NF.08.51.04



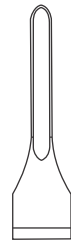

NF.08.51.53



NF.08.51.54

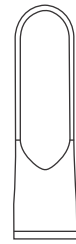

NF.08.51.58

LEKSELL  
36 cm/ 14 1/2"

# Orthopedic Instruments

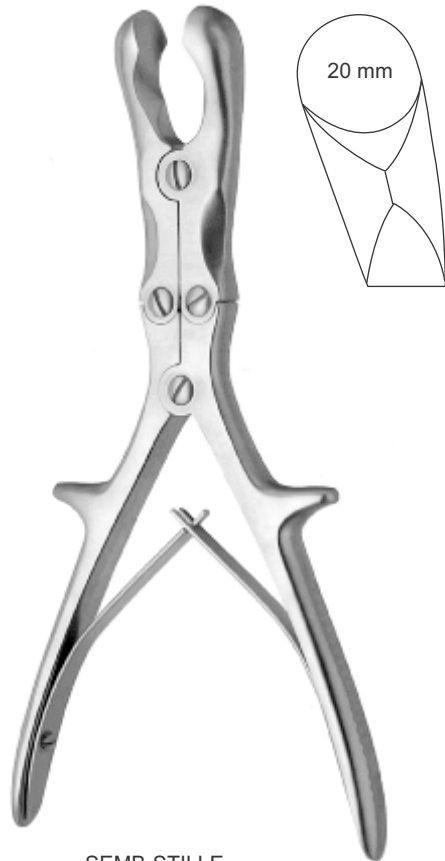

**SEMB-STILLE**  
NF.08.52.23 23 cm/ 9"  
NF.08.52.27 27 cm/ 10¾"



**RUSKIN**  
NF.08.56.18  
18 cm/ 7¼"



**STILLE-RUSKIN**  
NF.08.58.24  
24 cm/ 9½"

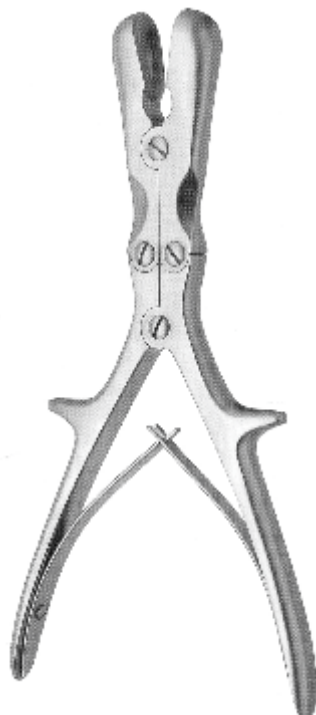

**STILLE-LUER**

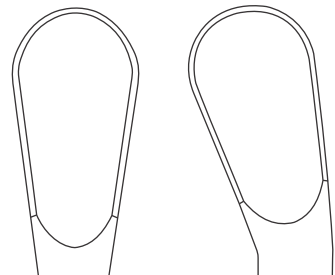

NF.08.60.23  
23 cm/ 9"

NF.08.61.23  
23 cm/ 9"

NF.08.60.27  
27 cm/ 10¾"

NF.08.61.27  
27 cm/ 10¾"



# Orthopedic Instruments

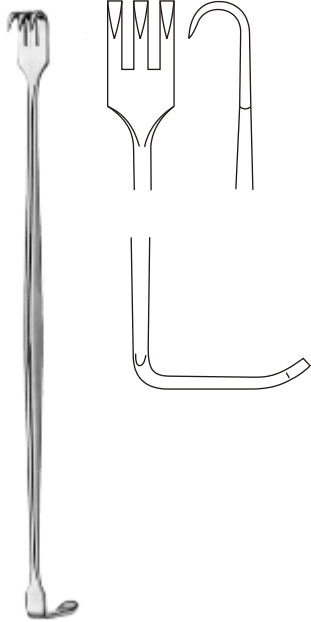

**SENN-MILLER**  
NF.08.01.16  
16 cm / 6¼"

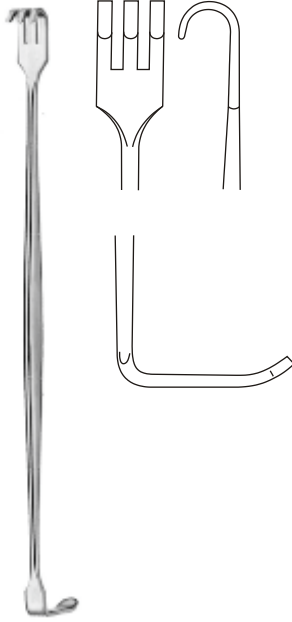

**SENN-MILLER**  
NF.08.02.16  
16 cm / 6¼"

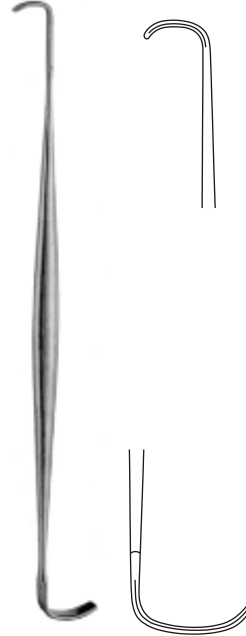

**RAGNELL**  
NF.08.05.16  
16 cm / 6¼"



**COPE**  
NF.08.05.18  
18 cm / 7⅞"



**CUSHING**

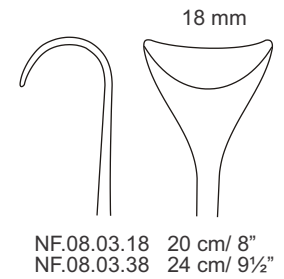
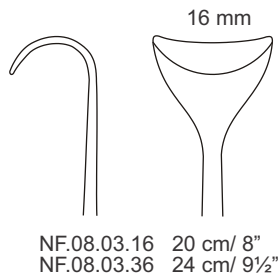
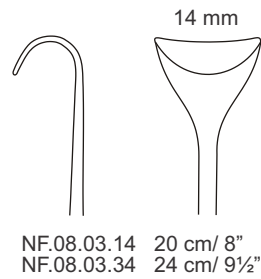
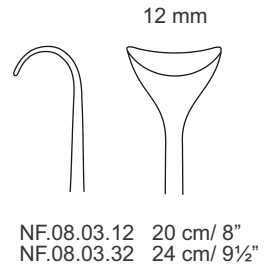
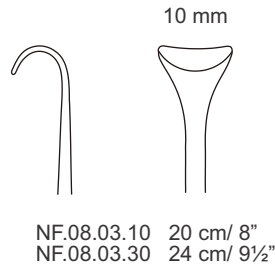
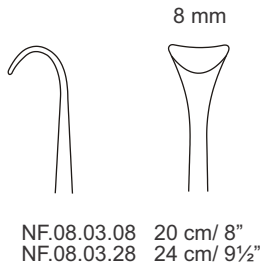

Vein retractors

# Orthopedic Instruments

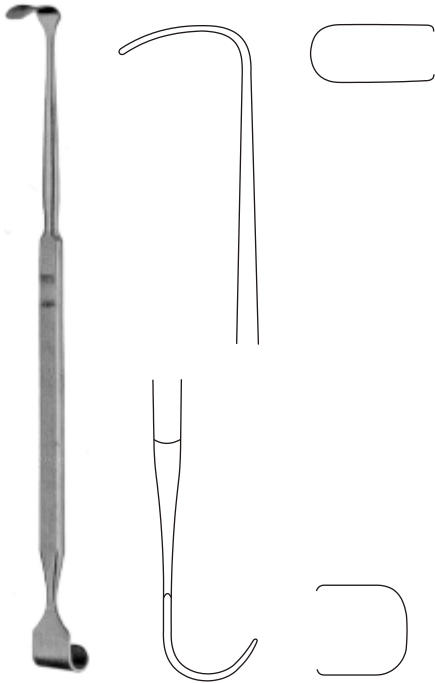

**LUKENS**  
NF.08.07.17  
17 cm/ 6¾"



**JACKSON**  
NF.08.07.27  
17 cm/ 6¾"

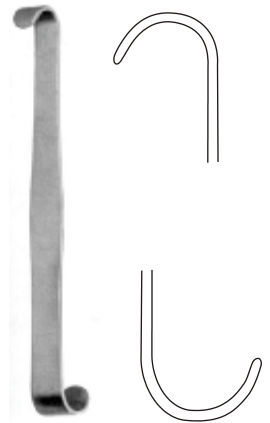

**LUER**  
NF.08.07.31  
11 cm/ 4¾"

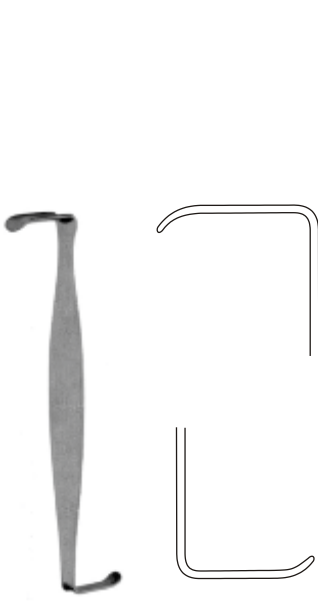

**CRILE**  
NF.08.07.41  
11 cm/ 4¾"

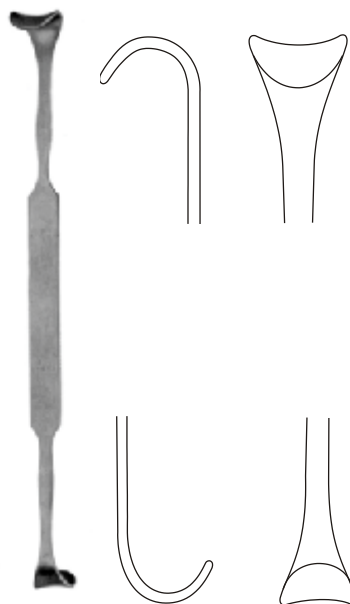

**ROSE**  
NF.08.07.46  
16 cm/ 6¼"

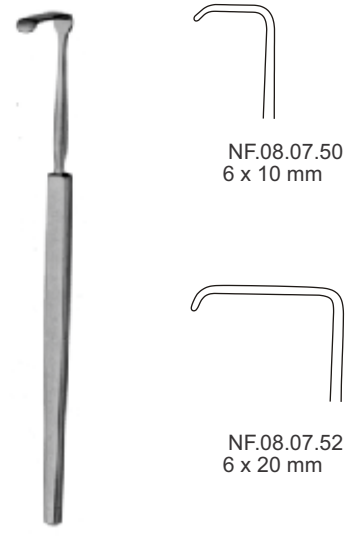

**SENN-GREEN**  
14 cm/ 5½"

NF.08.07.50  
6 x 10 mm

NF.08.07.52  
6 x 20 mm

# Orthopedic Instruments



3 x 15 mm

NF.08.07.58  
18 cm / 7 1/8"



NF.08.07.65  
6 X 25 mm

NF.08.07.66  
8 X 25 mm

LANGENBECK-GREEN  
17 cm / 6 3/4"



6 x 15 mm

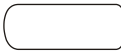

NF.08.07.75  
17 cm / 6 3/4"

6 x 18 mm



NF.08.07.85  
19 cm / 7 1/2"

STRANDELL-STILLE



GRAEFE  
16 cm / 6 1/4"



NF.08.08.01  
sharp

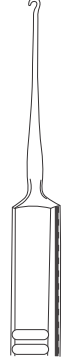

NF.08.08.02  
blunt



16 cm / 6 1/4"



NF.08.09.02

ADSON  
20 cm / 8"



NF.08.08.20  
3 mm



NF.08.09.20  
3 mm



CRILE  
NF.08.10.20  
20 cm / 8"



FRAZIER  
NF.08.11.12  
12.5 cm / 5"



GILLIES  
19 cm / 7 1/2"



NF.08.12.19



NF.08.12.20

# Orthopedic Instruments

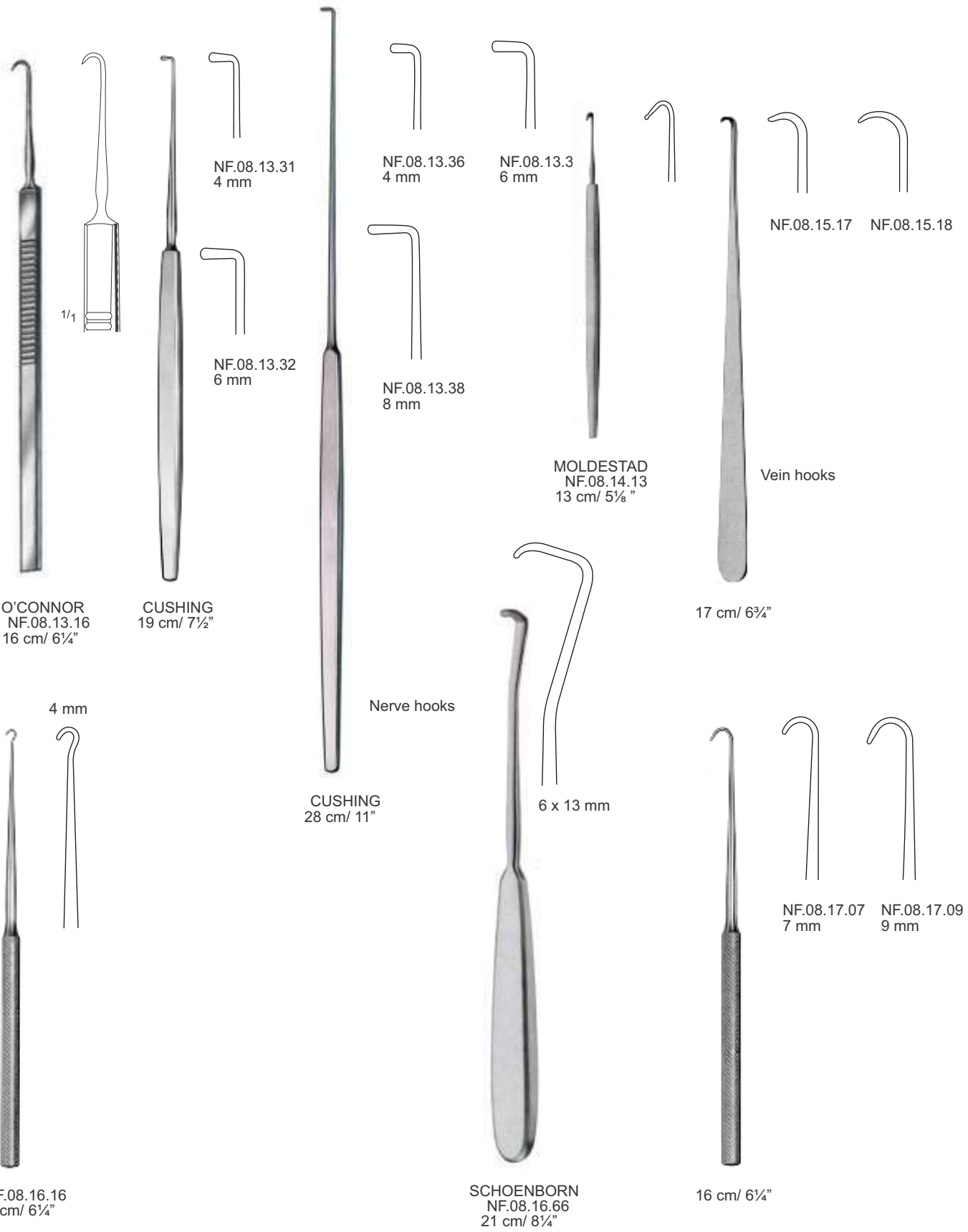

# Orthopedic Instruments

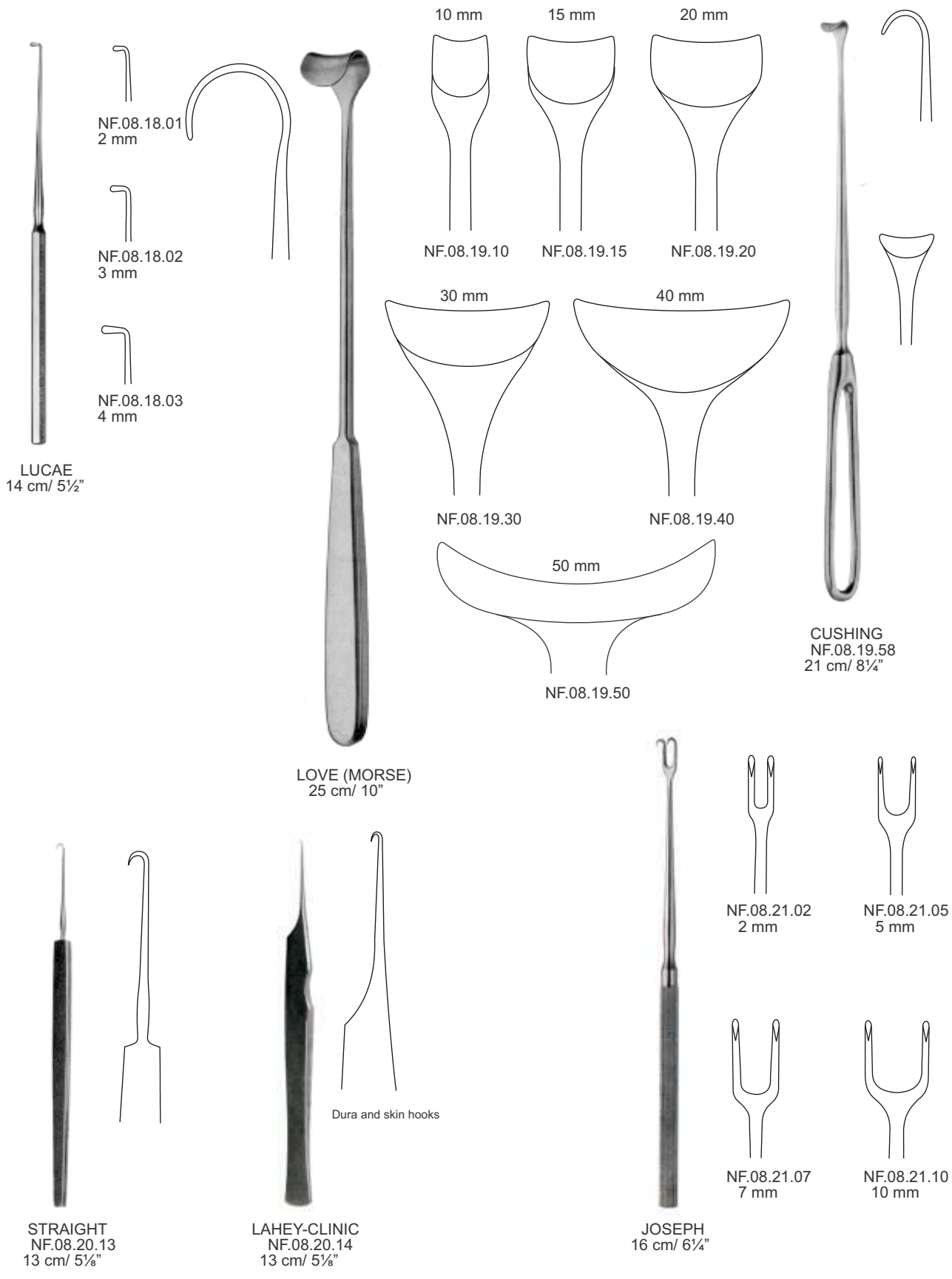



# Orthopedic Instruments

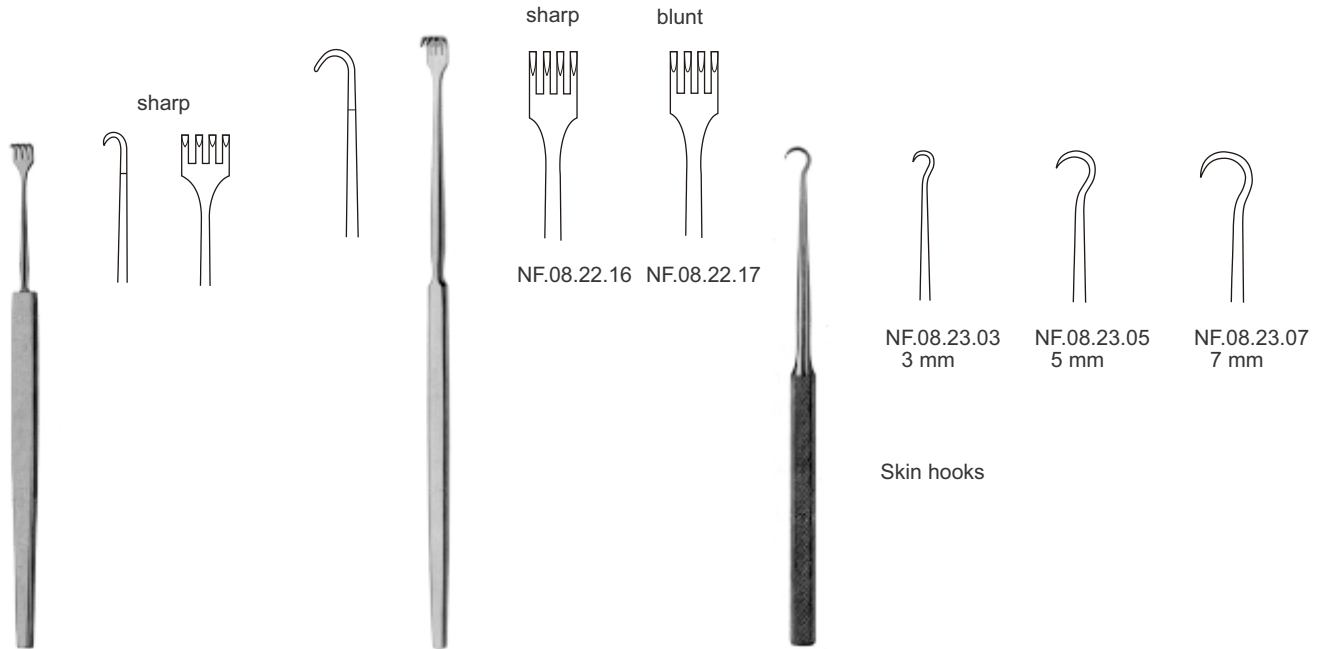

**ROLLET**  
NF.08.22.13  
13 cm / 5 1/8"

**KNAPP**  
16 cm / 6 1/4"

**KLEINERT-KUTZ**  
13 cm / 5 1/8"

NF.08.23.03  
3 mm

NF.08.23.05  
5 mm

NF.08.23.07  
7 mm

Skin hooks

Skin hooks

Tracheal hooks



**BARSKY**  
NF.08.23.15  
15 cm / 6"

**BARSKY**  
NF.08.23.16  
15 cm / 6"

**JACKSON**  
NF.08.24.14  
14.5 cm / 5 3/4"

**NEWS**  
NF.08.24.15  
15 cm / 6"

**JOSEPH**  
NF.08.24.16  
16 cm / 6 1/4"

**HUMBY**  
NF.08.24.21  
11.5 cm / 4 1/2"

**BERGMANN**  
NF.08.24.24  
14 cm / 5 1/2"

# Orthopedic Instruments



NF.08.24.26  
16.5 cm / 6½"



**COTTLE**  
NF.08.24.36  
16 cm / 6¼"



Fistula hook

**EMMET**  
NF.08.24.42  
22 cm / 8¾"



**BENICKE**  
19 cm / 7½"



NF.08.24.50  
sharp



NF.08.24.51  
blunt

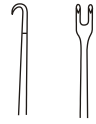

NF.08.25.13  
1.5 mm

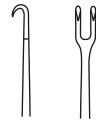

NF.08.25.23  
2 mm



**GUTHRIE**  
13 cm / 5¼"



**FREER**  
NF.08.25.15  
15 cm / 6"



**GUTHRIE**  
16 cm / 6¼"

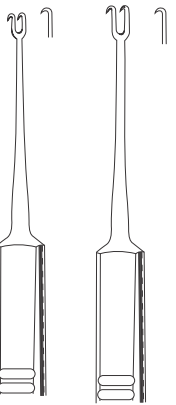

NF.08.25.16 NF.08.25.26



NF.08.26.16  
16 cm / 6¼"

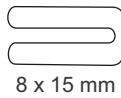

8 x 15 mm



**FORK**  
NF.08.26.36  
16 cm / 6¼"

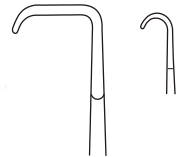

NF.08.26.42  
6 x 12 mm

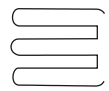

NF.08.26.43  
11 x 12 mm



16 cm / 6¼"

# Orthopedic Instruments

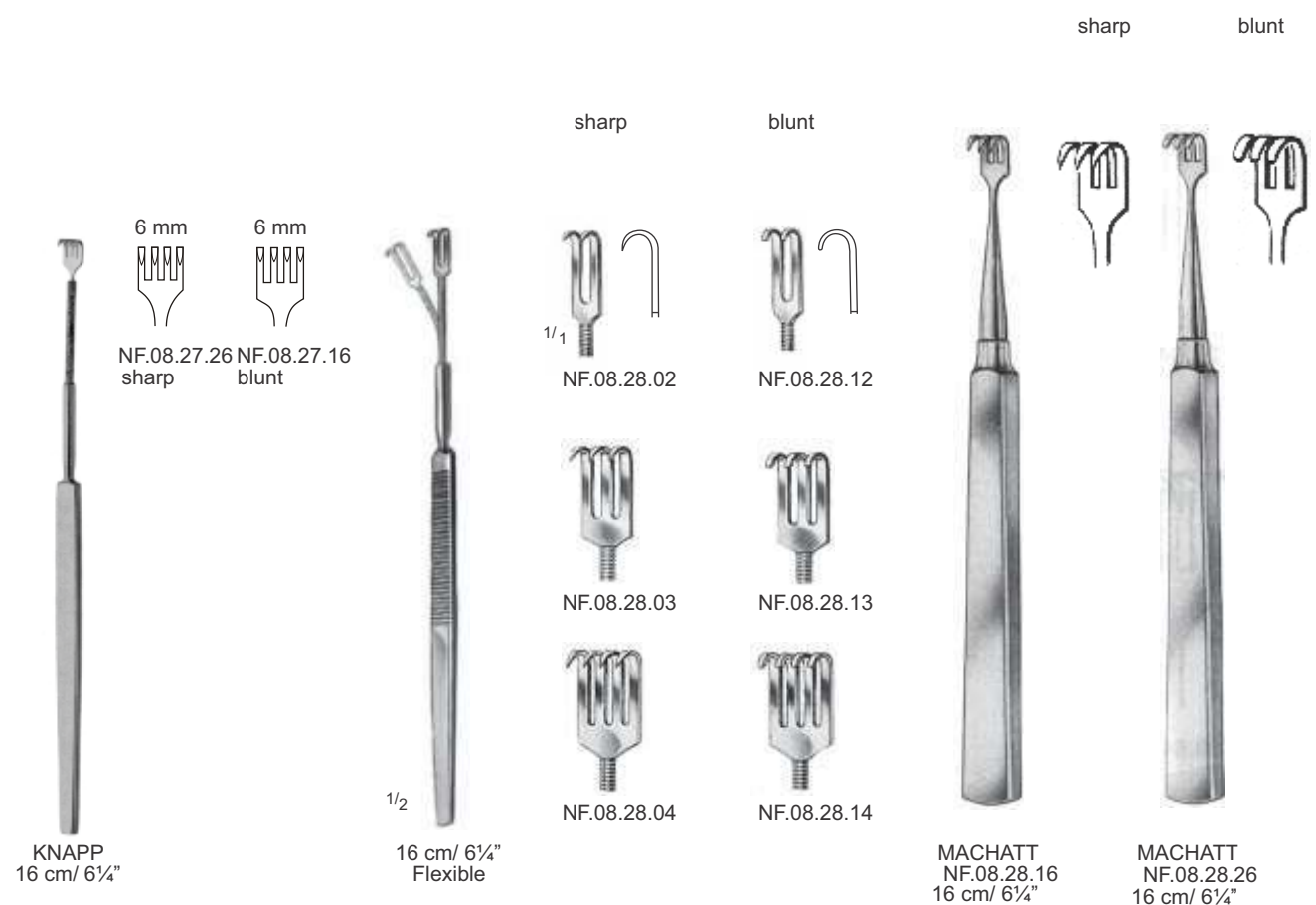

# Orthopedic Instruments

6 mm

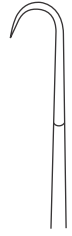

sharp



17 cm / 6 3/4"

NF.08.29.01

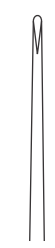

5 mm

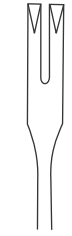

NF.08.29.02

8 mm

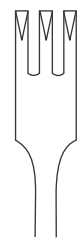

NF.08.29.03

11 mm

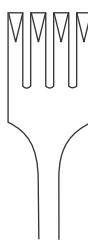

NF.08.29.04

6 mm

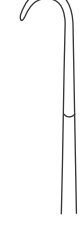

blunt



17 cm / 6 3/4"

NF.08.30.01



NF.08.30.02

8 mm

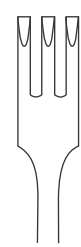

NF.08.30.03

11 mm

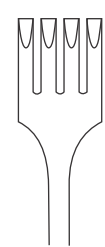

NF.08.30.04

9 mm



16 cm / 6 1/4"

NF.08.31.01



8 mm

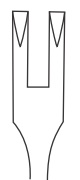

NF.08.31.02

10 mm

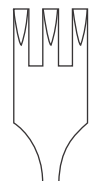

NF.08.31.03

14 mm

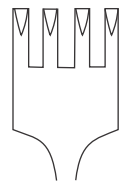

NF.08.31.04

9 mm

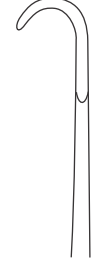

16 cm / 6 1/4"

NF.08.31.11



8 mm

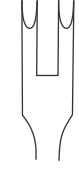

NF.08.31.12

10 mm

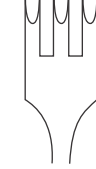

NF.08.31.13

14 mm

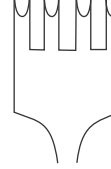

NF.08.31.14

2 mm



LAHEY CLINIC  
NF.08.31.15  
13 cm / 5 1/8"

# Orthopedic Instruments

7 mm

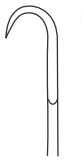

sharp



16 cm / 6 1/4"

NF.08.31.21

5 mm



NF.08.31.22

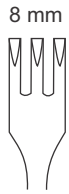

NF.08.31.23

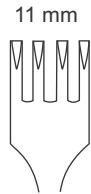

NF.08.31.24

7 mm



blunt



16 cm / 6 1/4"

NF.08.31.31



NF.08.31.32

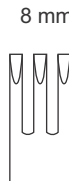

NF.08.31.33

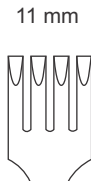

NF.08.31.34

5 mm



16 cm / 6 1/4"

with flexible shaft

NF.08.32.62

7 mm



NF.08.32.63

5 mm



16 cm / 6 1/4"

NF.08.33.62

7 mm



NF.08.33.63

4 mm



**MINI-LANGENBECK**  
16cm / 6 1/4"



NF.08.32.10  
10 x 6 mm

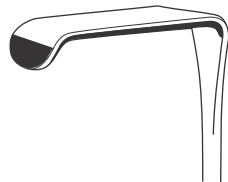

NF.08.32.17  
17 x 5 mm

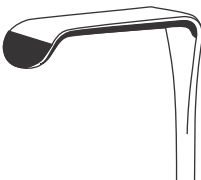

NF.08.32.20  
20 x 6 mm

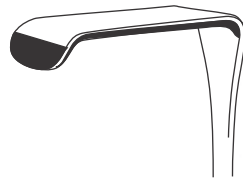

NF.08.32.22  
22 x 8 mm



**MEYERDING**  
18cm / 7 1/8"

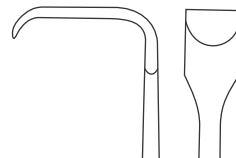

NF.08.33.01  
7 x 18 mm

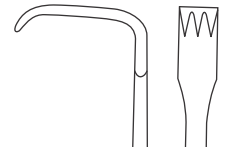

NF.08.33.02  
5 x 16 mm

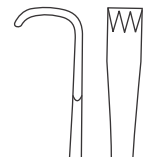

NF.08.33.03  
4 x 7 mm

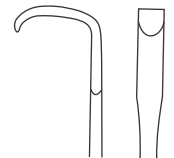

NF.08.33.04  
3 x 10 mm

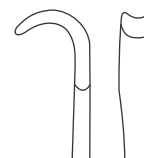

NF.08.33.05  
4 x 7 mm

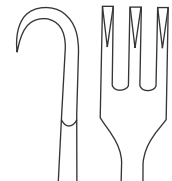

NF.08.33.06  
4 x 10 mm

# Orthopedic Instruments

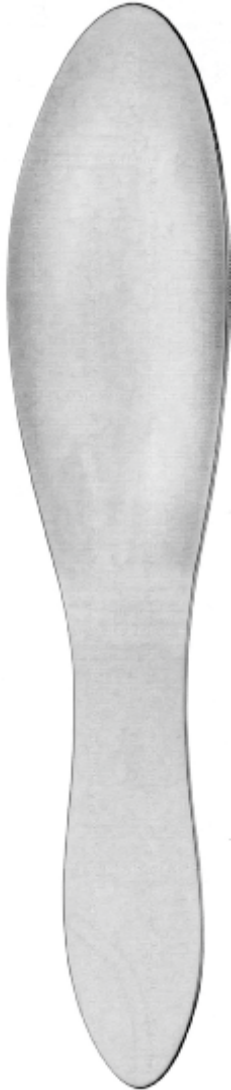

REVERDIN  
NF.08.35.29  
45/60 x 290 mm



REVERDIN  
NF.08.36.28  
5/60 x 290 mm



RIBBON  
47 cm - 18½"

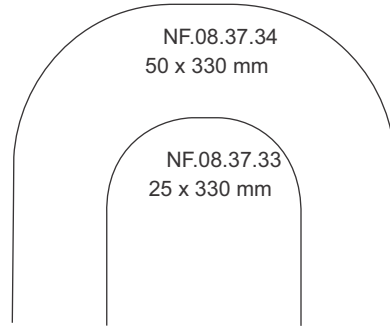

stainless

flexible



HABERER  
NF.08.40.20  
20 cm / 8", 17/25 mm  
NF.08.40.28  
28 cm / 11", 25/30 mm  
NF.08.40.30  
30 cm / 12", 37/45 x 300 mm

stainless



NF.08.38.30 30 x 330 mm  
NF.08.38.40 40 x 330 mm  
NF.08.38.50 50 x 330 mm  
NF.08.38.60 75 x 330 mm

malleable



TUFFIER  
NF.08.39.20  
17/25 x 200 mm

malleable

# Orthopedic Instruments



malleable

- NAWROOZ**  
NF.08.41.05 15 x 200 mm  
NF.08.41.06 6 x 200 mm  
NF.08.41.10 10 x 200 mm  
NF.08.41.12 12 x 200 mm  
NF.08.41.17 17 x 200 mm  
NF.08.41.20 20 x 200 mm



**COLLIN**  
NF.08.41.15  
16.5 cm/ 6½"



malleable

- NF.08.41.55 27 x 250 mm  
NF.08.41.65 35 x 250 mm

# Orthopedic Instruments



**MAYO-COLLIN**  
NF.08.42.15  
15 cm / 6"



**PARKER**  
NF.08.43.18  
18 cm / 7 1/8"



**PARKER**  
NF.08.43.13  
13 cm / 5 1/8"



**PARKER-MOTT**  
NF.08.43.26  
16.5 cm / 6 1/2"



# Orthopedic Instruments



SOFIELD  
NF.08.44.50  
Set complete

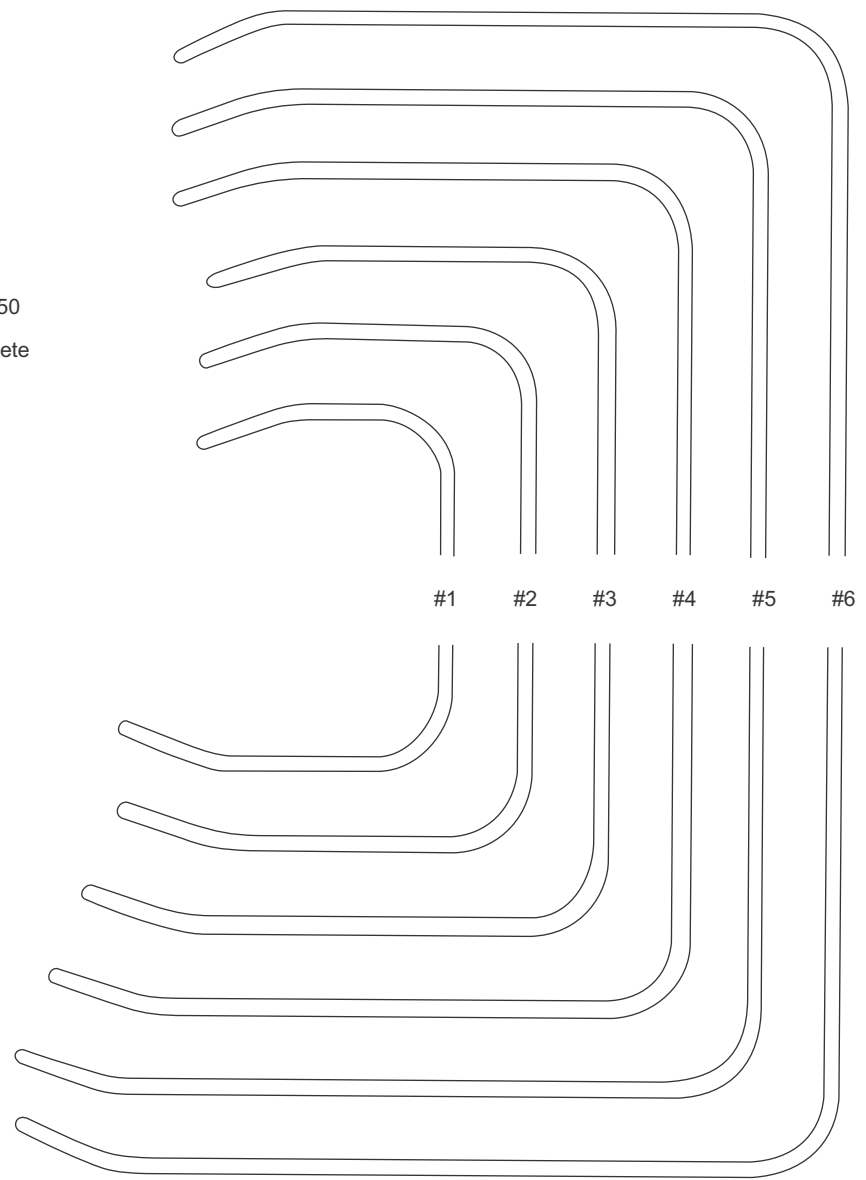

NF.08.44.59

**SOFIELD**

NF.08.44.51	# 1	18 cm/ 7 <sup>1</sup> / <sub>6</sub> "	13 x 45 mm/ 13 x 35 mm
NF.08.44.52	# 2	19 cm/ 7 <sup>1</sup> / <sub>2</sub> "	13 x 55 mm/ 16 x 45 mm
NF.08.44.53	# 3	20 cm/ 8"	16 x 70 mm/ 16 x 55 mm
NF.08.44.54	# 4	21 cm/ 8 <sup>1</sup> / <sub>4</sub> "	16 x 85 mm/ 16 x 70 mm
NF.08.44.55	# 5	22 cm/ 8 <sup>3</sup> / <sub>4</sub> "	19 x 100 mm/ 19 x 80 mm
NF.08.44.56	# 6	23 cm/ 9"	19 x 110 mm/ 19 x 90 mm

# Orthopedic Instruments

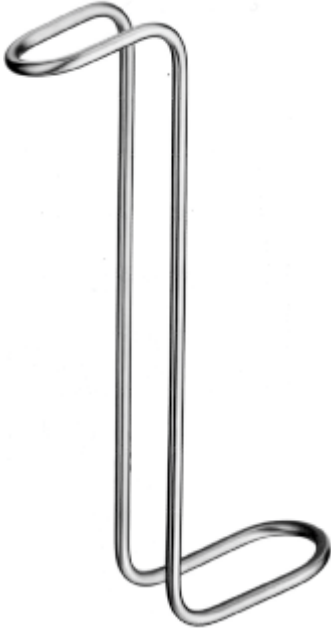

**COLLIN-HARTMANN**  
NF.08.45.16  
16 cm/ 6¼"

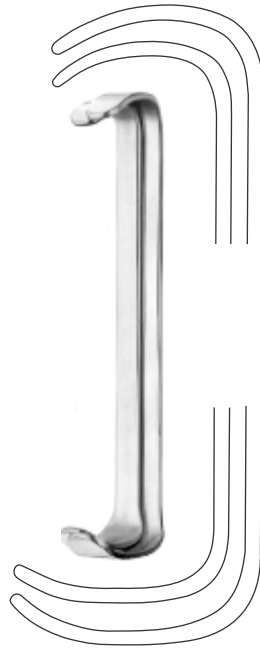

**FARABEUFBABY**  
NF.08.46.12  
12 cm/ 4¾"



**FARABEUFB**  
NF.08.47.15  
15 cm/ 6"

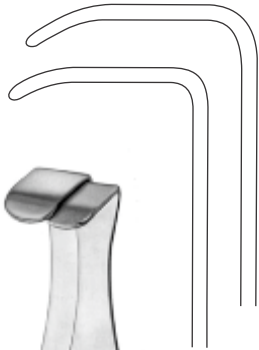

**PARKER-LANGENBECK  
(US-ARMY)**  
NF.08.48.21  
21 cm/ 8¼"



**FACE  
RETRACTOR**  
NF.08.50.21  
11.5 cm 4½"

# Orthopedic Instruments

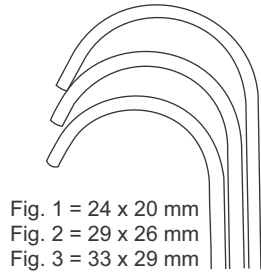

Fig. 1 = 24 x 20 mm  
Fig. 2 = 29 x 26 mm  
Fig. 3 = 33 x 29 mm

Fig. 1,2,3  
Fig. 1 = 30 x 28 mm  
Fig. 2 = 36 x 36 mm  
Fig. 3 = 38 x 43 mm



**FREEMAN**  
NF.08.50.11  
21.8 cm / 8½"



**ROUX**  
NF.08.50.13  
13 cm / 5¼"

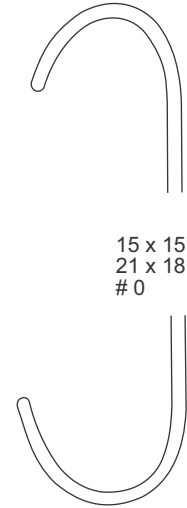

15 x 15 mm  
21 x 18 mm  
# 0

**ROUX**  
NF.08.49.01 Fig 1 = 15 cm / 6"  
NF.08.49.02 Fig 2 = 16 cm / 6¼"  
NF.08.49.03 Fig 3 = 17 cm / 6¾"

NF.08.49.10  
Set complete



**ROUX "S"**  
NF.08.49.50  
Set complete

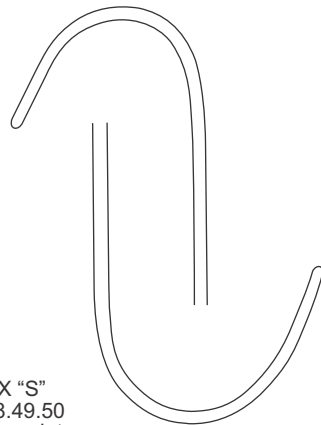

NF.08.49.64  
# 1  
14 cm / 5½"  
22 x 20 mm  
28 x 25 mm



NF.08.49.65  
# 2  
15 cm / 6"  
26 x 23 mm  
38 x 29 mm

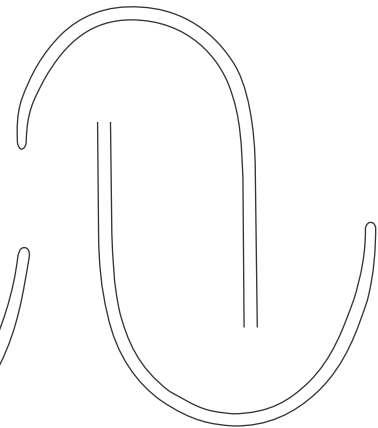

NF.08.49.66  
# 3  
16.5 cm / 6½"  
29 x 29 mm  
44 x 34 mm

# Orthopedic Instruments



**MATHIEU**  
NF.08.51.20  
20 cm / 8"

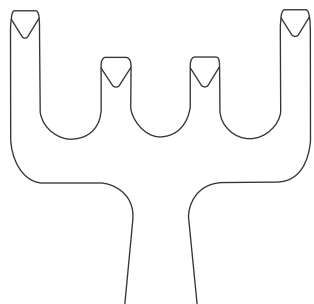

**WALTER**  
NF.08.51.39  
19 cm / 7½"

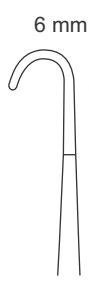
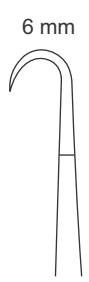

**VOLKMANN**  
12 cm / 4¾"



**VOLKMANN**  
12 cm / 4¾"

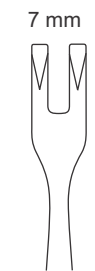

7 mm  
NF.08.52.02

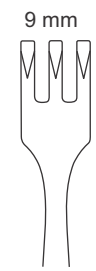

9 mm  
NF.08.52.03

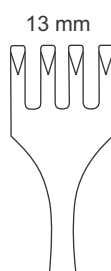

13 mm  
NF.08.52.04

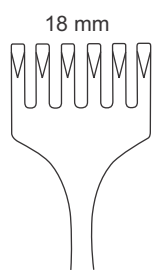

18 mm  
NF.08.52.06

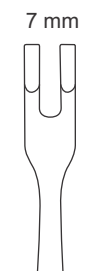

7 mm  
NF.08.53.02

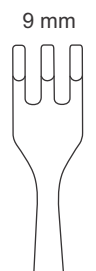

9 mm  
NF.08.53.03

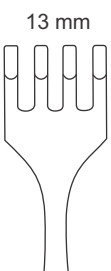

13 mm  
NF.08.53.04

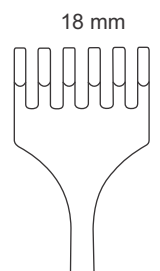

18 mm  
NF.08.53.06

# Orthopedic Instruments

10 mm

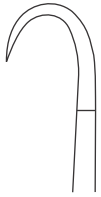

9 mm

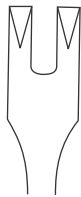

NF.08.54.02

13 mm

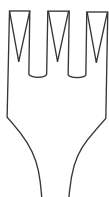

NF.08.54.03

15 mm



NF.08.55.20

18 mm

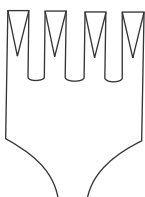

NF.08.54.04

28 mm

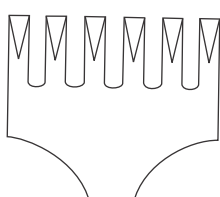

NF.08.54.06

15 mm

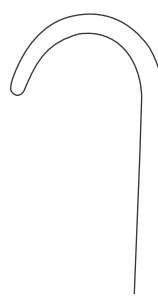

NF.08.55.21



**VOLKMANN**  
20 cm / 8"



**VOLKMANN**  
21 cm / 8¼"



**BONE HOOK**  
20.3 cm / 8"  
NF.08.55.30 sharp      NF.08.55.31 blunt

10 mm

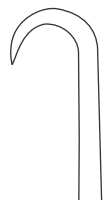

NF.08.55.28

20 mm

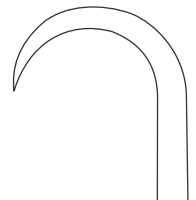

NF.08.55.29

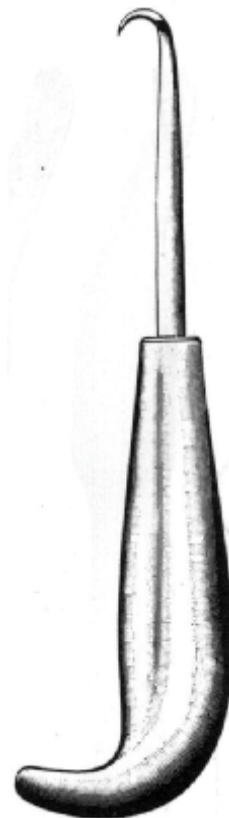

19 cm / 7½"

# Orthopedic Instruments



VOLKMANN  
20 cm/ 8"

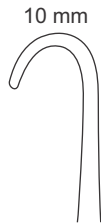

10 mm



9 mm

NF.08.56.02

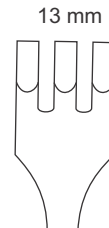

13 mm

NF.08.56.03

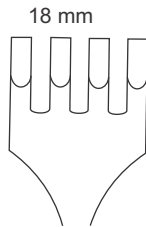

18 mm

NF.08.56.04

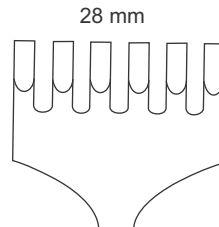

28 mm

NF.08.56.06



VOLKMANN  
22 cm/ 8¾"

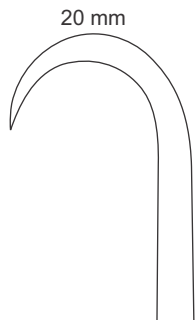

20 mm

NF.08.57.21

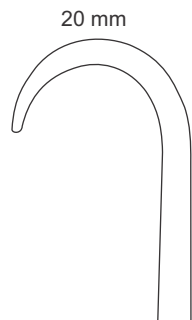

20 mm

NF.08.57.31

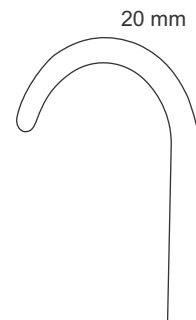

20 mm

NF.08.57.41

# Orthopedic Instruments

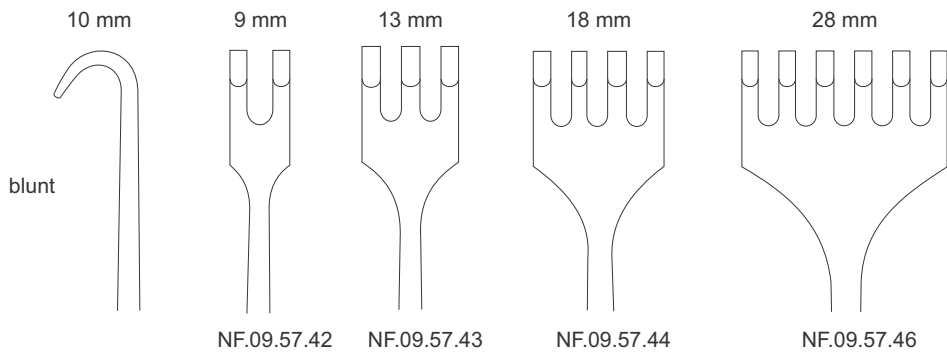
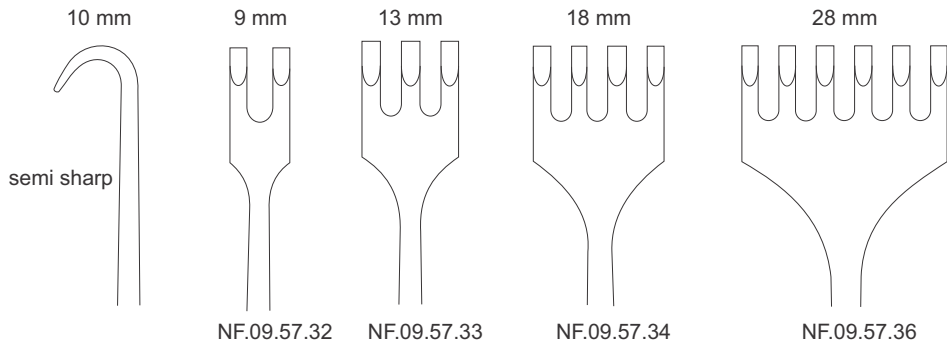
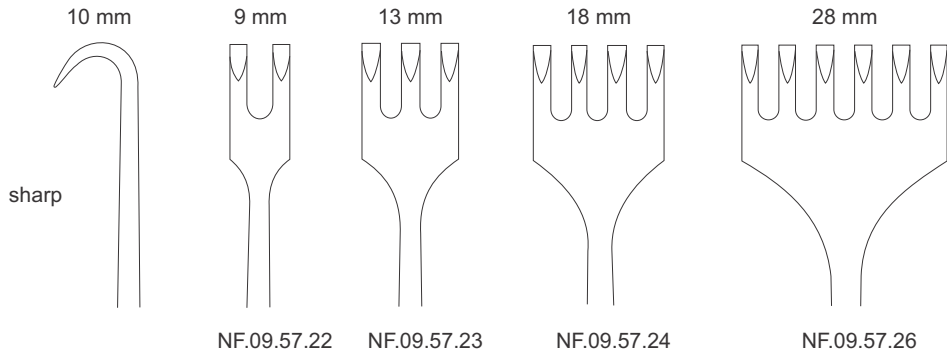

**VOLKMANN**  
22 cm / 8<sup>3</sup>/<sub>4</sub>"

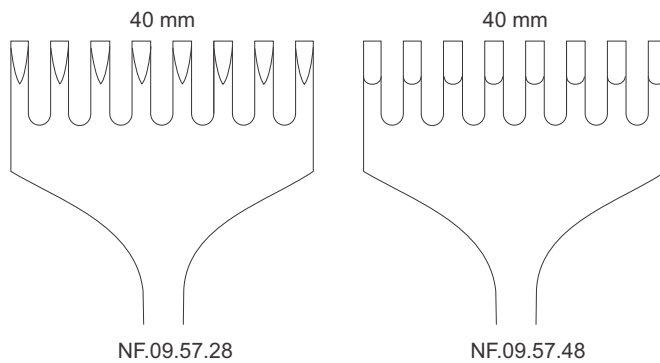

# Orthopedic Instruments



VOLKMANN  
21 cm / 8¼"

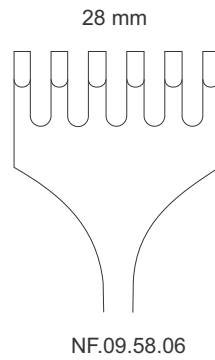
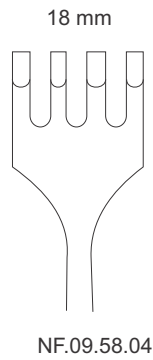
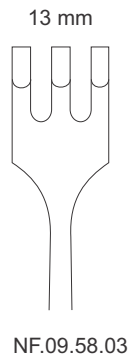
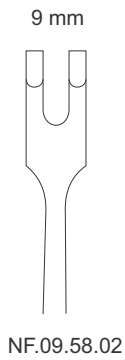

VOLKMANN  
21 cm / 8¼"

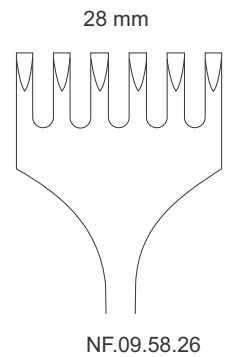
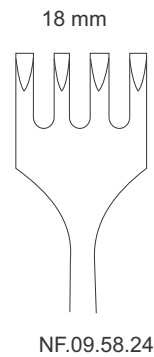
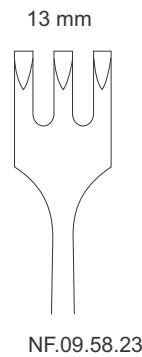
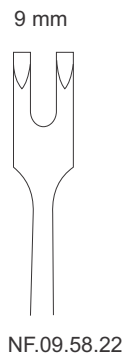
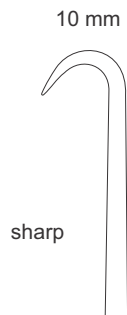



# Orthopedic Instruments

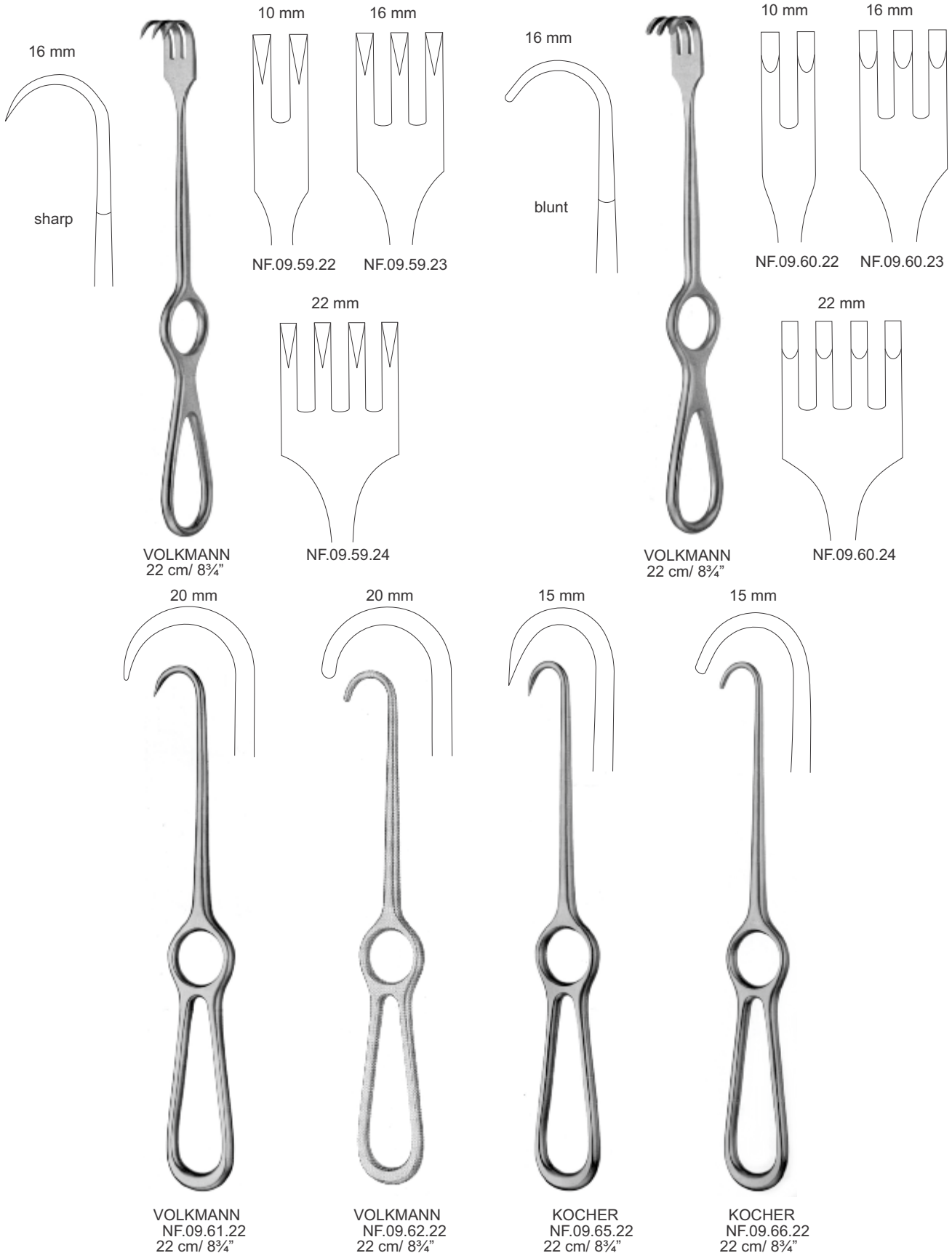

# Orthopedic Instruments

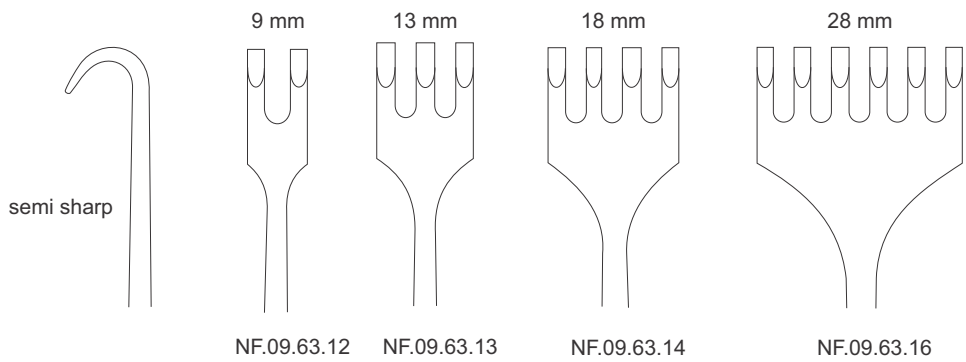
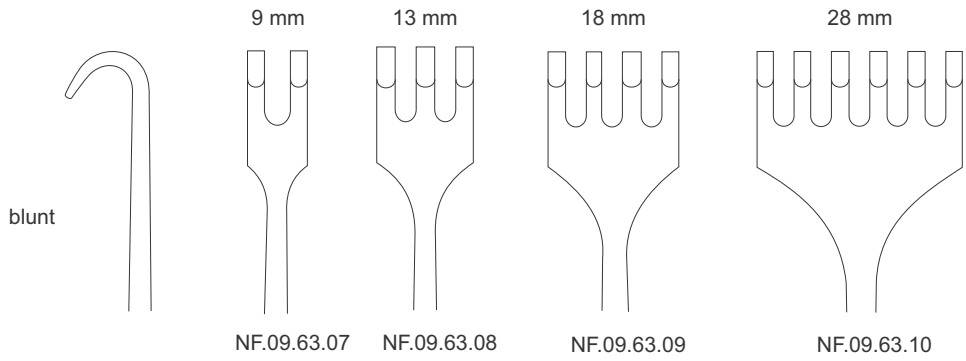
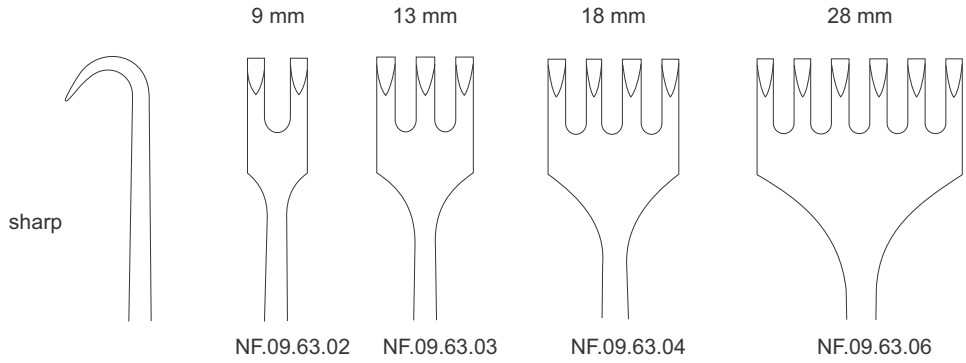

**VOLKMANN**  
22 cm/ 8¾"

# Orthopedic Instruments

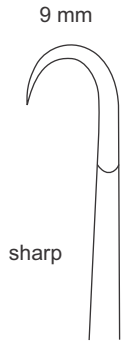

**MURPHY**  
19.5 cm / 7¾"

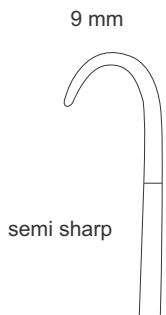
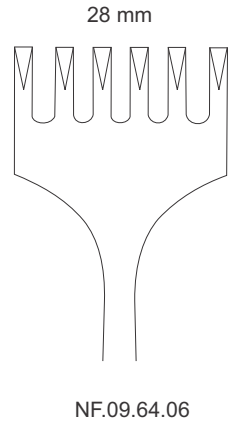
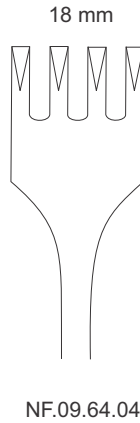
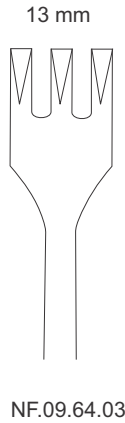
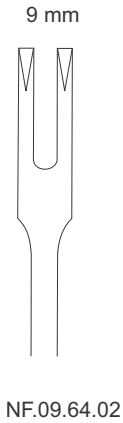

**KOCHER**  
22 cm / 8¾"

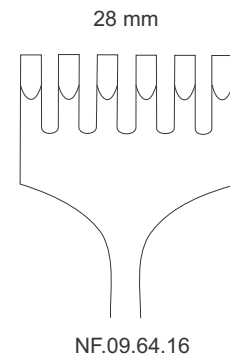
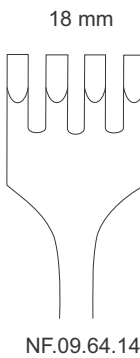
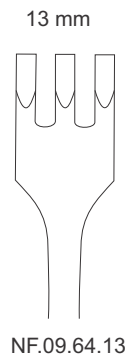
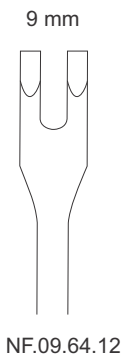

# Orthopedic Instruments



LANGENBECK  
21 cm/ 8¼"

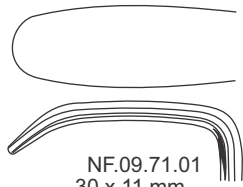

NF.09.71.01  
30 x 11 mm

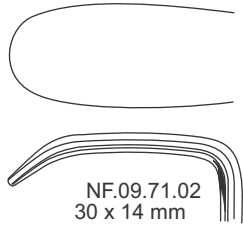

NF.09.71.02  
30 x 14 mm

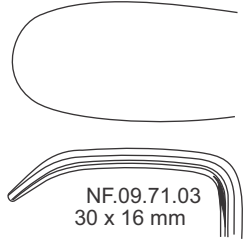

NF.09.71.03  
30 x 16 mm

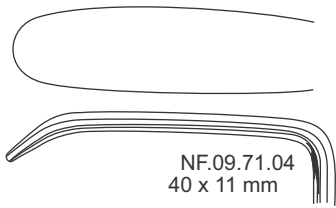

NF.09.71.04  
40 x 11 mm

NF.09.72.04  
40 x 11 mm

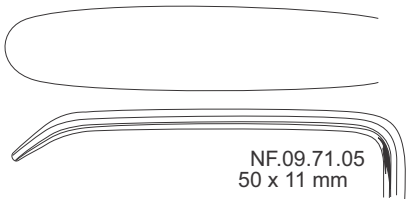

NF.09.71.05  
50 x 11 mm



LANGENBECK  
21 cm/ 8¼"

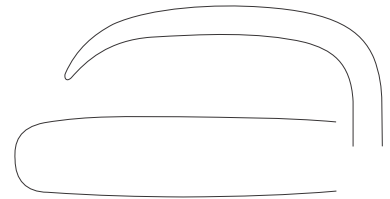

NF.09.71.10  
10 x 40 mm

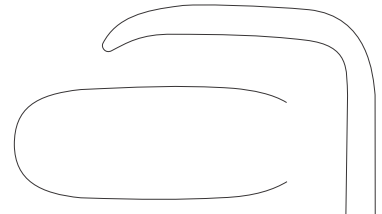

NF.09.71.12  
14 x 33 mm

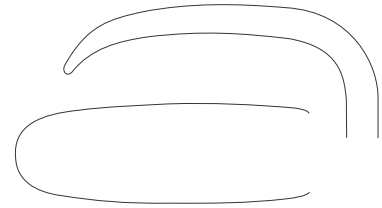

NF.09.71.13  
13 x 42 mm

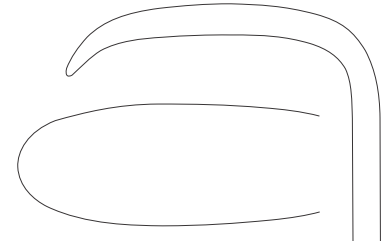

NF.09.71.16  
16 x 42 mm

# Orthopedic Instruments



LANGENBECK  
21 cm/ 8¼"

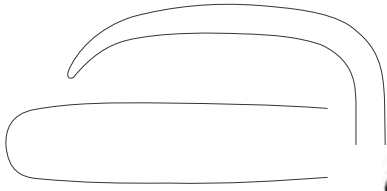

NF.09.72.10  
10 x 40 mm

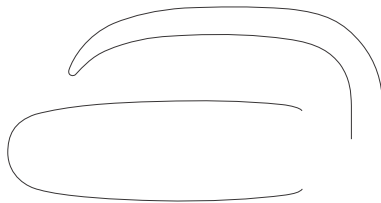

NF.09.72.13  
13 x 42 mm

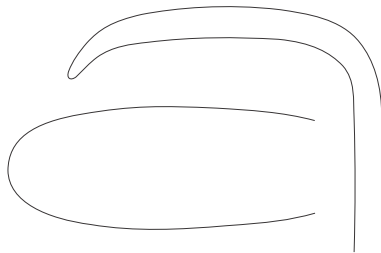

NF.09.72.16  
16 x 42 mm



LANGENBECK  
21 cm/ 8¼"

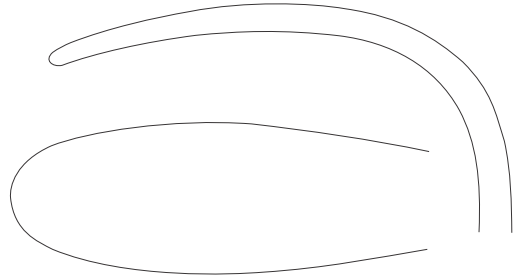

NF.09.72.20  
20 x 55 mm

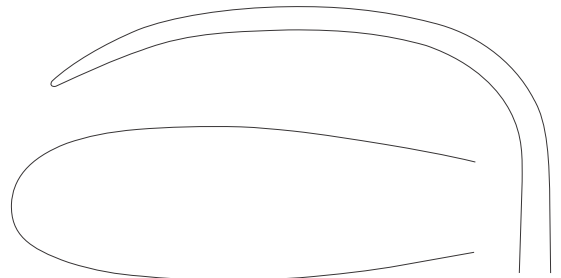

NF.09.72.21  
20 x 63 mm

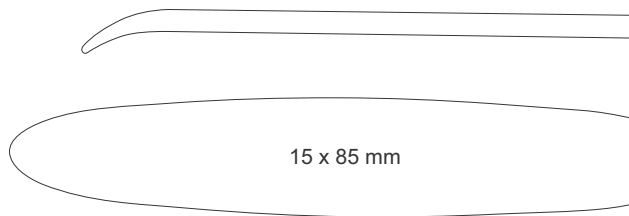

15 x 85 mm



LANGENBECK  
NF.09.72.25  
21 cm/ 8¼"

# Orthopedic Instruments



**KOCHER**  
NF.09.65.22  
22 cm / 8<sup>3</sup>/<sub>4</sub>"



**KOCHER**  
NF.09.66.22  
22 cm / 8<sup>3</sup>/<sub>4</sub>"

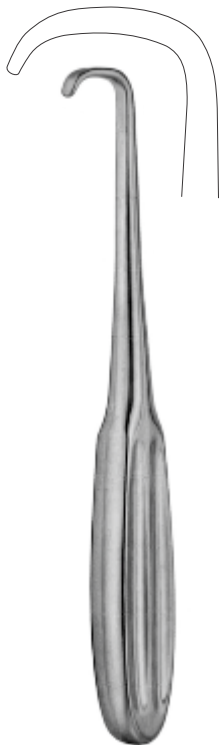

**LAHEY**  
NF.09.69.95  
19.5 cm / 7<sup>3</sup>/<sub>4</sub>"



**BILLROTH**  
25 cm / 10"

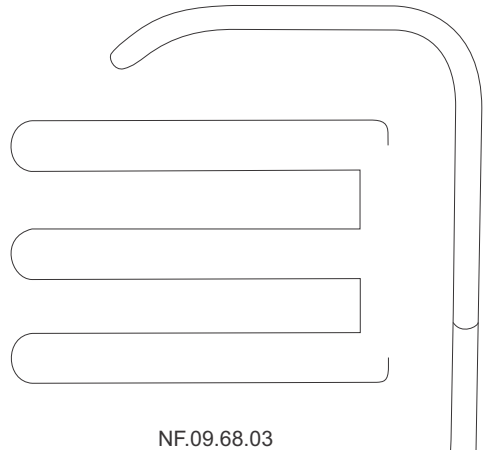

NF.09.68.03  
35 X 43 mm

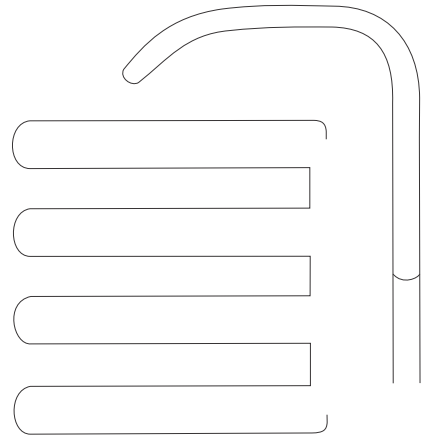

NF.09.68.04  
40 X 35 mm

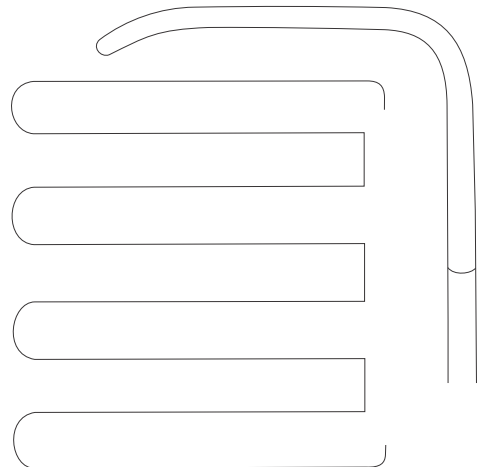

NF.09.68.14  
50 X 45 mm

# Orthopedic Instruments



LANGENBECK  
21 cm / 8¼"



NF.09.70.10  
10 x 28 mm

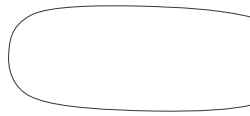

NF.09.70.14  
14 x 28 mm

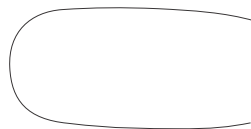

NF.09.70.16  
16 x 28 mm

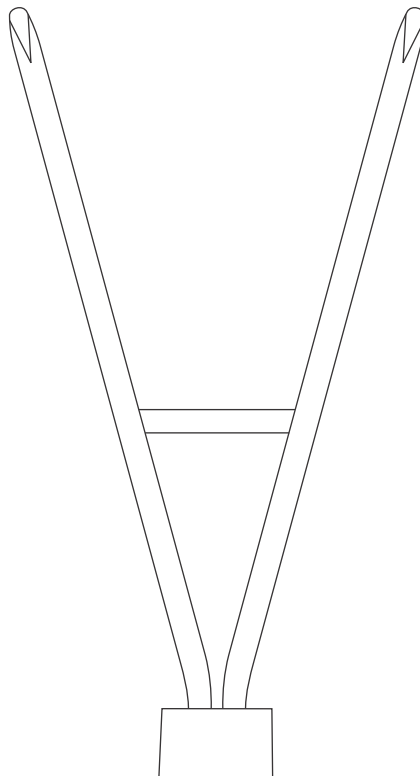

BERENS  
NF.09.67.21  
21 cm / 8¼"

# Orthopedic Instruments



**KOERTE**  
24 cm / 9½"

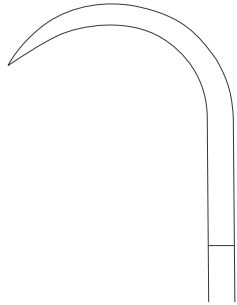

NF.09.75.08  
40 x 28 mm

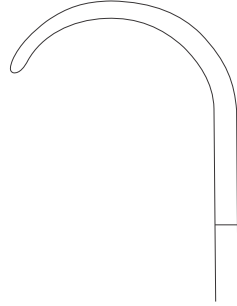

NF.09.76.18  
40 x 28 mm



NF.09.76.26  
24 cm / 9½"

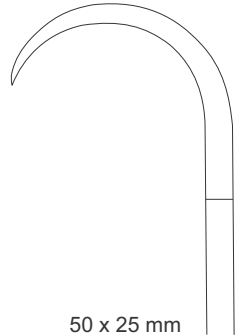

50 x 25 mm



NF.09.76.28  
25 cm / 10"

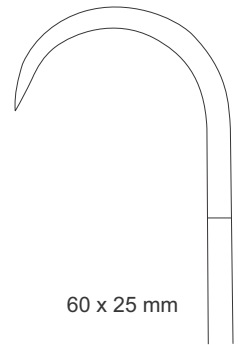

60 x 25 mm





KOCHER  
22 cm / 8¾"

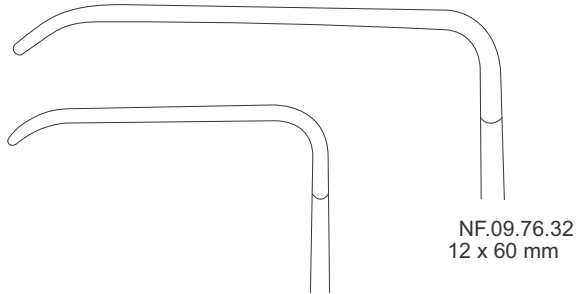

NF.09.76.31  
12 x 40 mm

NF.09.76.32  
12 x 60 mm



KOCHER  
23 cm / 9"

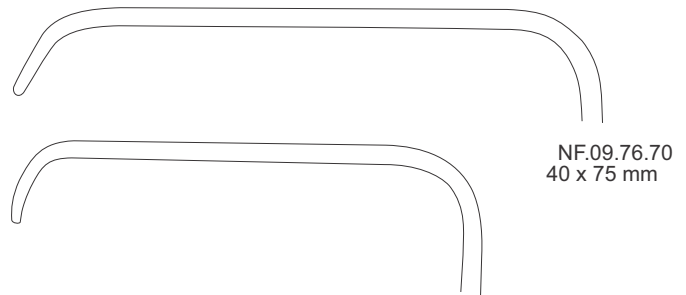

NF.09.76.70  
40 x 75 mm

NF.09.76.60  
20 x 60 mm

NF.09.76.55  
25 x 60 mm

NF.09.76.50  
30 x 60 mm

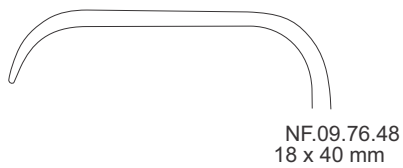

NF.09.76.48  
18 x 40 mm

# Orthopedic Instruments



**SAUERBRUCH**  
23 cm / 9"

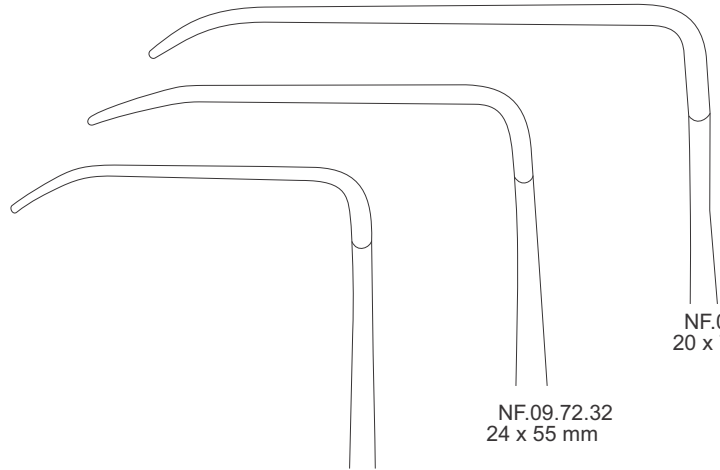

NF.09.72.31  
18 x 45 mm

NF.09.72.32  
24 x 55 mm

NF.09.72.33  
20 x 72 mm



**KOCHER**  
21 cm / 8 1/4"

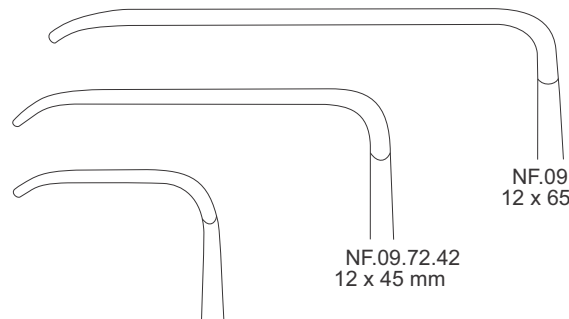

NF.09.72.41  
8 x 25 mm

NF.09.72.42  
12 x 45 mm

NF.09.72.43  
12 x 65 mm

# Orthopedic Instruments



**KOCHER**  
23 cm / 9"

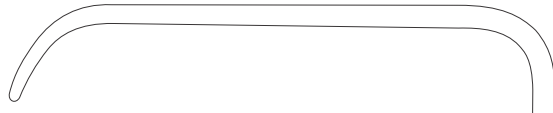

NF.09.72.57  
30 x 70 mm

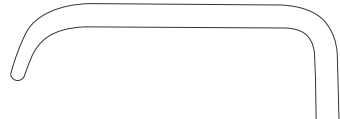

NF.09.72.54  
30 x 40 mm

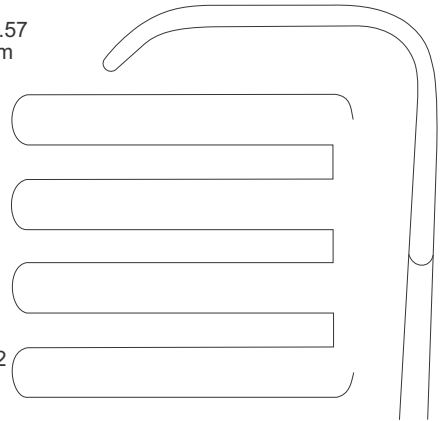

NF.09.74.22  
40 x 40 mm

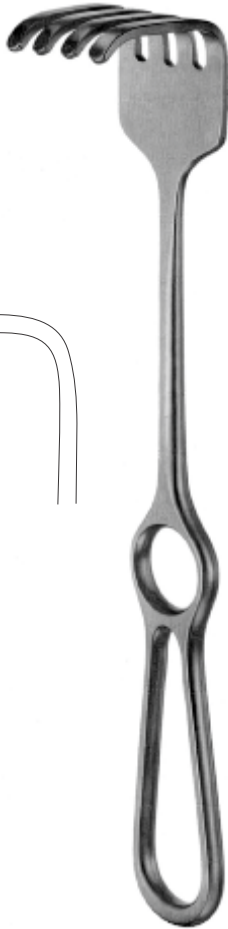

**ISRAEL**  
25 cm / 10"

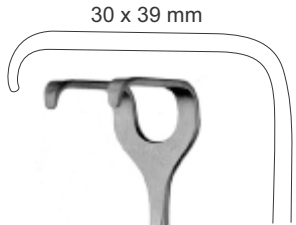

30 x 39 mm

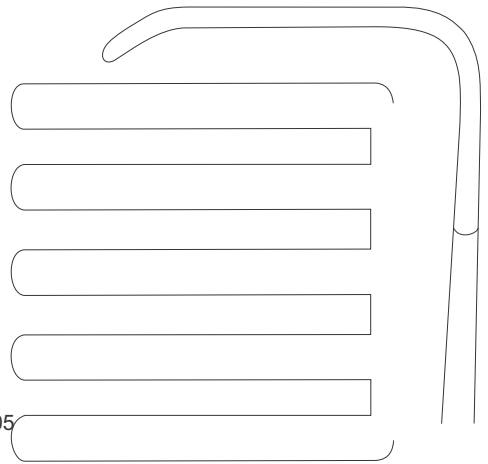

NF.09.74.05  
50 x 45 mm

**OLLIER**  
NF.09.73.22  
22 cm / 8 3/4"

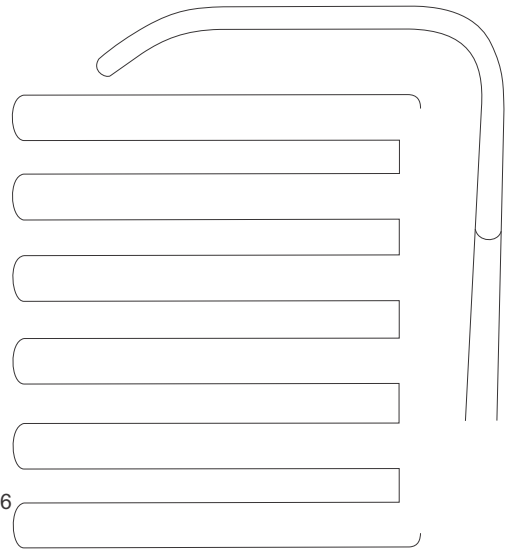

NF.09.74.06  
60 x 50 mm

# Orthopedic Instruments



LANGENBECKOCHER  
21 cm/ 8¼"

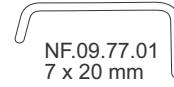

NF.09.77.01  
7 x 20 mm

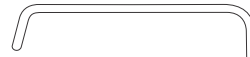

NF.09.77.02 7 x 30 mm  
NF.09.77.03 10 x 30 mm  
NF.09.77.04 15 x 30 mm  
NF.09.77.05 20 x 30 mm



NF.09.77.06 10 x 40 mm  
NF.09.77.07 15 x 40 mm  
NF.09.77.08 20 x 40 mm

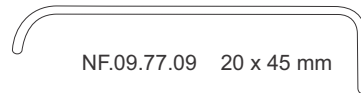

NF.09.77.09 20 x 45 mm

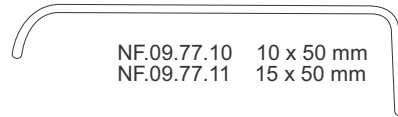

NF.09.77.10 10 x 50 mm  
NF.09.77.11 15 x 50 mm

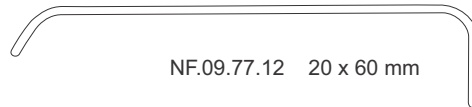

NF.09.77.12 20 x 60 mm

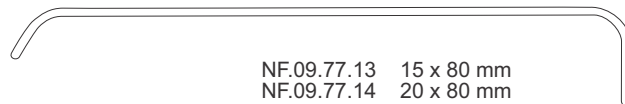

NF.09.77.13 15 x 80 mm  
NF.09.77.14 20 x 80 mm

# Orthopedic Instruments

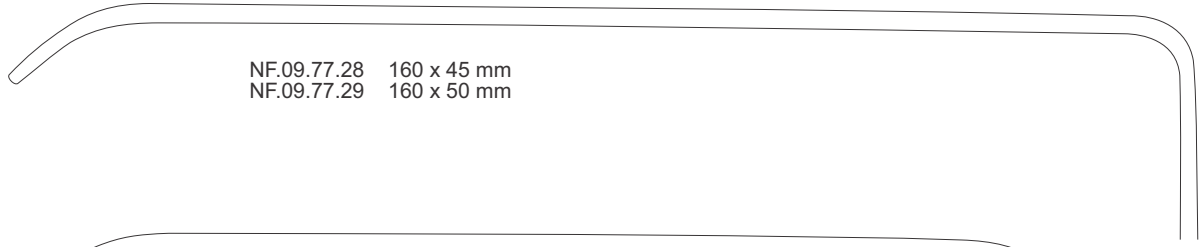

NF.09.77.28 160 x 45 mm  
NF.09.77.29 160 x 50 mm

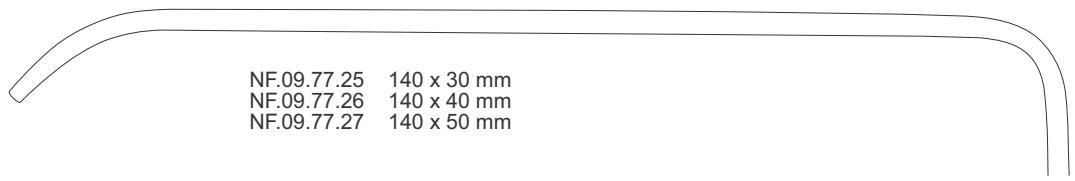

NF.09.77.25 140 x 30 mm  
NF.09.77.26 140 x 40 mm  
NF.09.77.27 140 x 50 mm

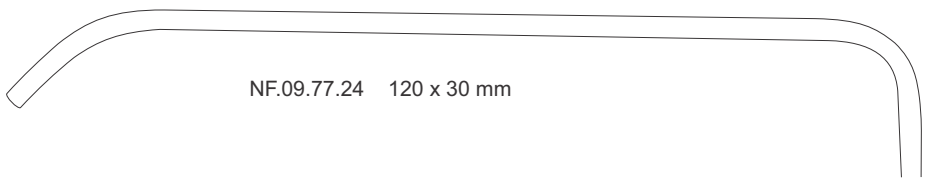

NF.09.77.24 120 x 30 mm

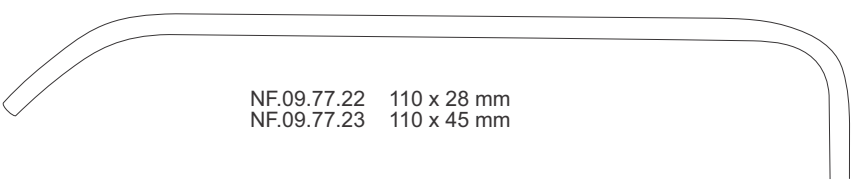

NF.09.77.22 110 x 28 mm  
NF.09.77.23 110 x 45 mm

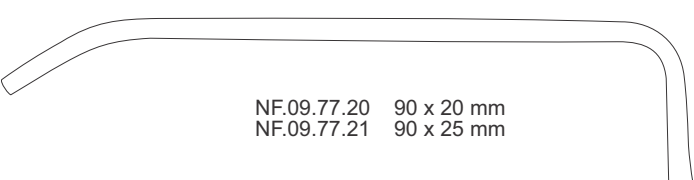

NF.09.77.20 90 x 20 mm  
NF.09.77.21 90 x 25 mm



for anterior spondylosis operations

24 cm/ 9½"

# Orthopedic Instruments

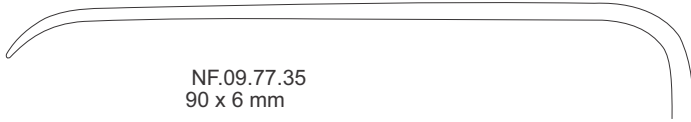

NF.09.77.35  
90 x 6 mm

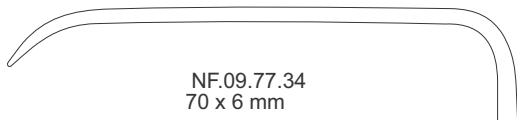

NF.09.77.34  
70 x 6 mm

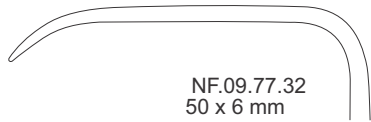

NF.09.77.32  
50 x 6 mm



Joint retractor,  
oval rounded blades



50 x 55 mm

conical tip



22 cm/ 8¾"



MORRIS  
NF.09.78.21  
22.5 cm/ 9"

# Orthopedic Instruments

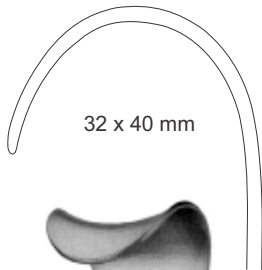

32 x 40 mm

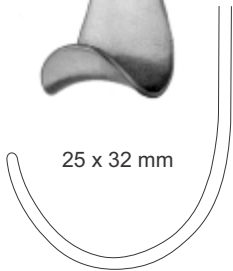

25 x 32 mm

**GOELET**  
NF.09.80.19  
19 cm / 7½"



**KOCHER**  
20 cm / 8"

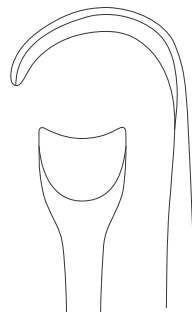

NF.09.81.01  
12 x 19 mm

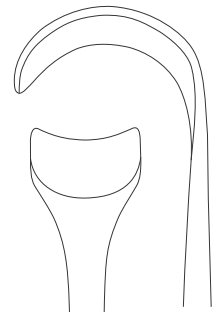

NF.09.81.02  
15 x 21 mm

# Orthopedic Instruments

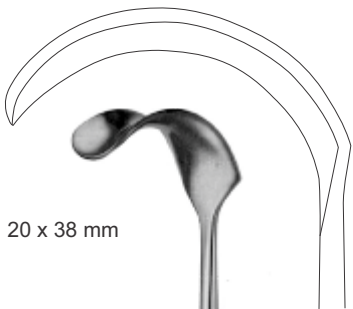

20 x 38 mm

KOCHER  
NF.09.83.23  
23 cm/ 9"



KOCHER  
25.5 cm/ 10"

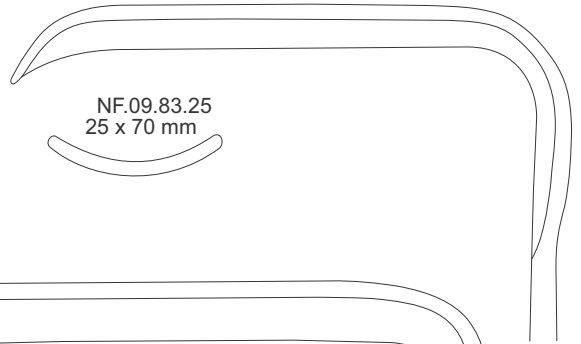

NF.09.83.25  
25 x 70 mm

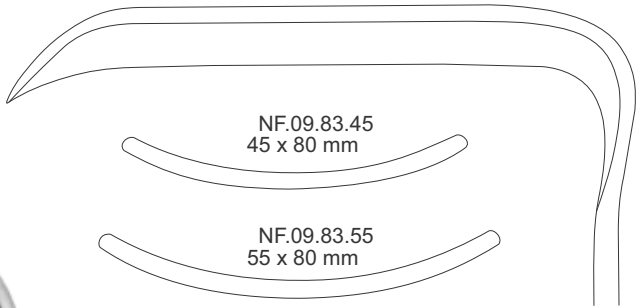

NF.09.83.45  
45 x 80 mm

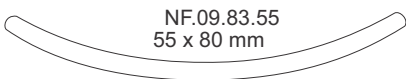

NF.09.83.55  
55 x 80 mm

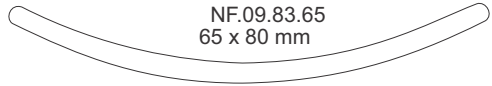

NF.09.83.65  
65 x 80 mm



# Orthopedic Instruments

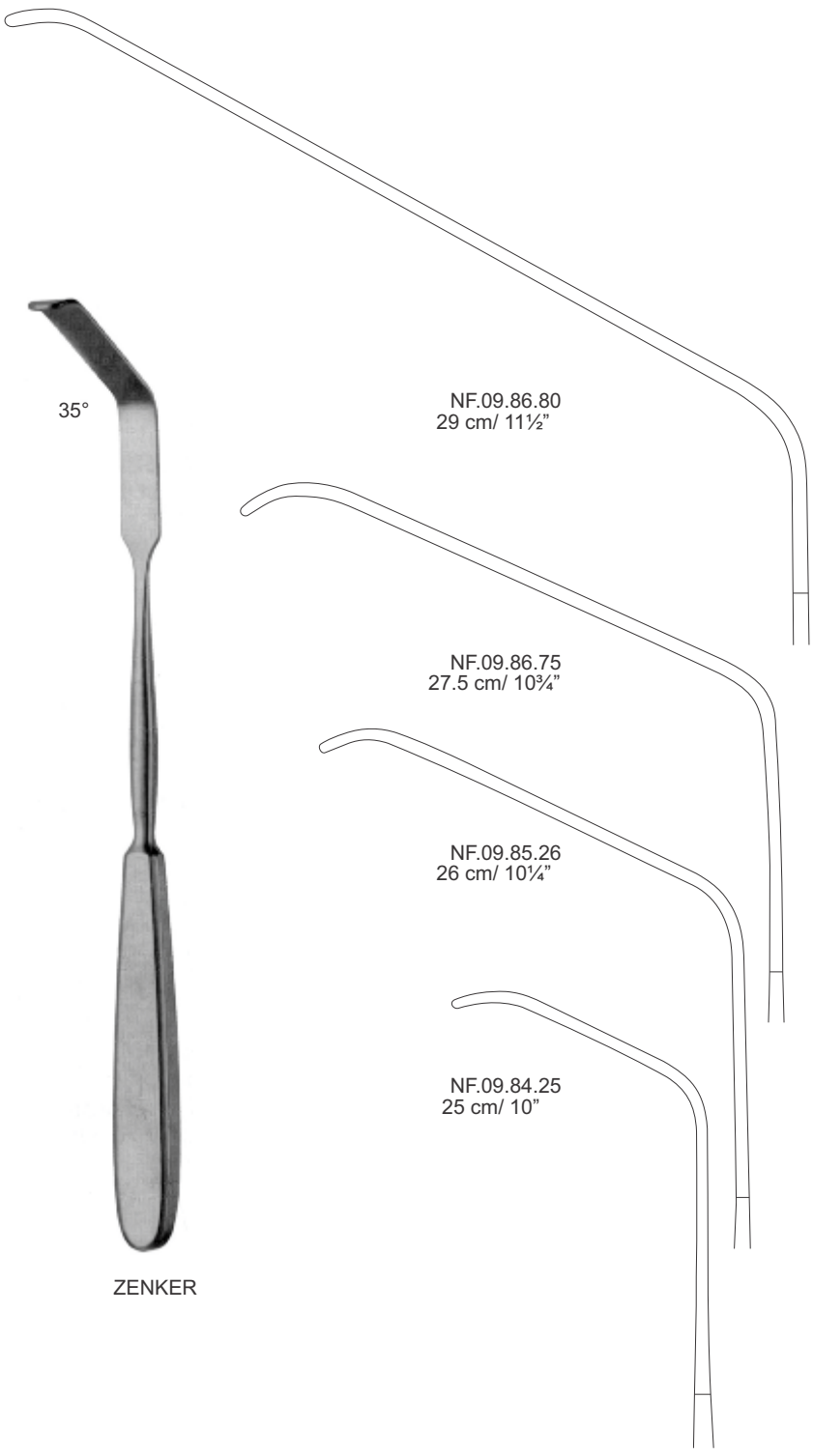

# Orthopedic Instruments

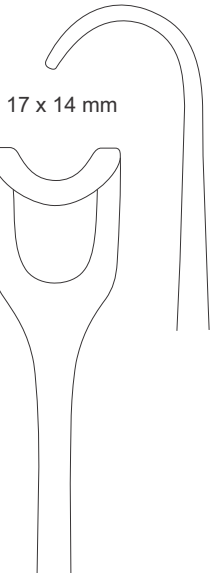

17 x 14 mm

NF.09.87.01  
19.5 cm / 7¾"

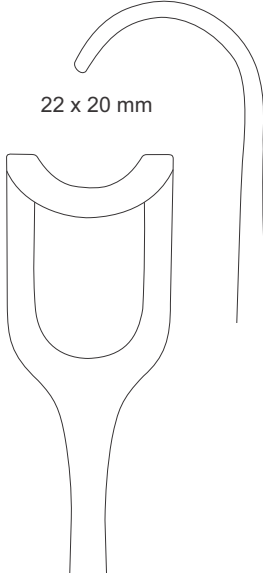

22 x 20 mm

NF.09.87.02  
20.5 cm / 8½"

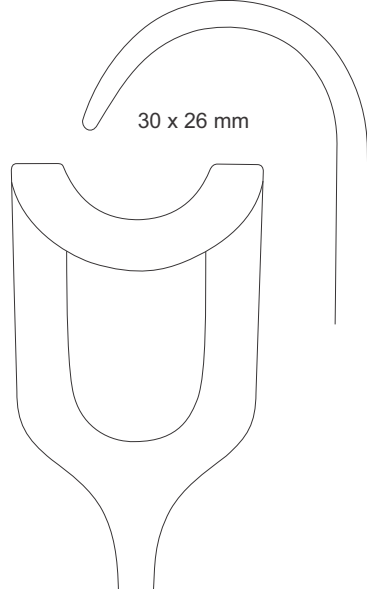

30 x 26 mm

NF.09.87.03  
23 cm / 9"

MIDDELDORPF

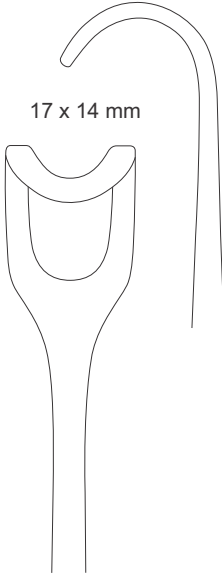

17 x 14 mm

NF.09.88.11  
20.5 cm / 8½"

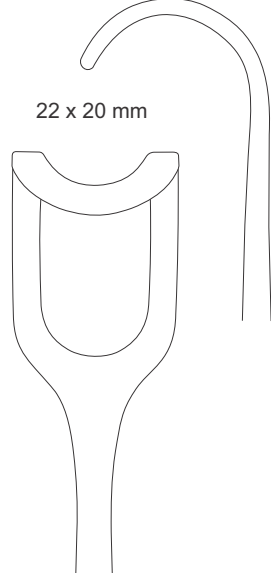

22 x 20 mm

NF.09.88.12  
22.5 cm / 9"

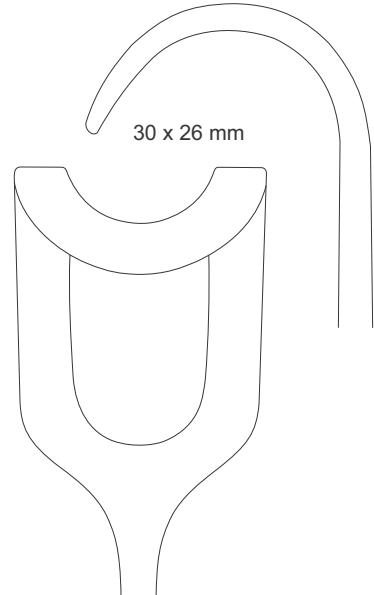

30 x 26 mm

NF.09.88.13  
23.5 cm / 9¼"

MIDDELDORPF

# Orthopedic Instruments

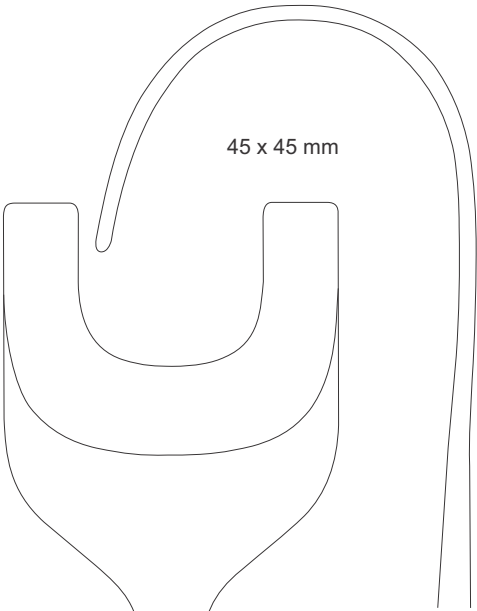

NF.09.89.21

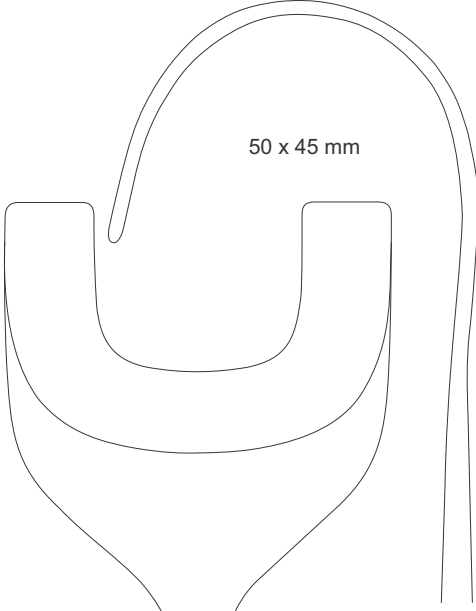

NF.09.89.22



**MIDDELDORPF**  
25 cm / 10"

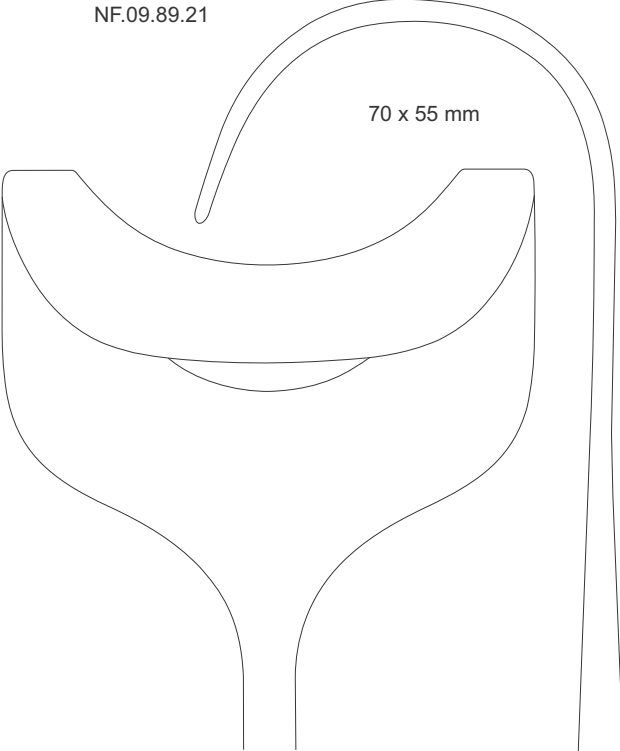

NF.09.89.23

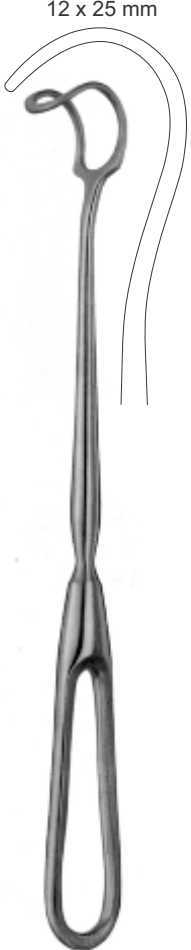

**GREEN**  
NF.09.90.12  
25.3 cm / 9"

# Orthopedic Instruments

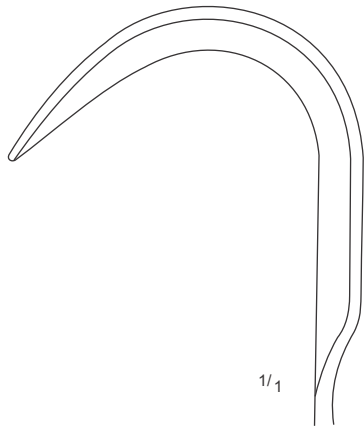

1/1



1/2

**FRITSCH**  
23 cm / 9"

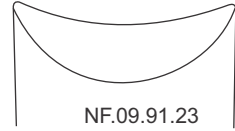

NF.09.91.23  
30 x 30 mm

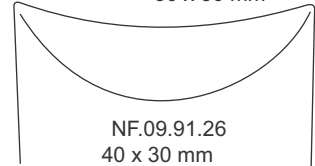

NF.09.91.26  
40 x 30 mm

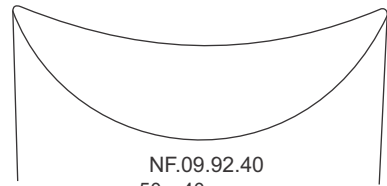

NF.09.92.40  
50 x 40 mm

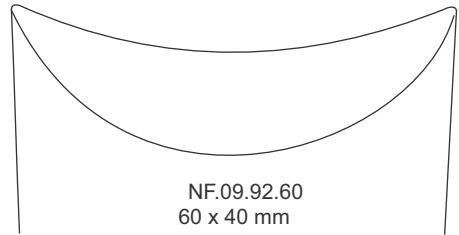

NF.09.92.60  
60 x 40 mm

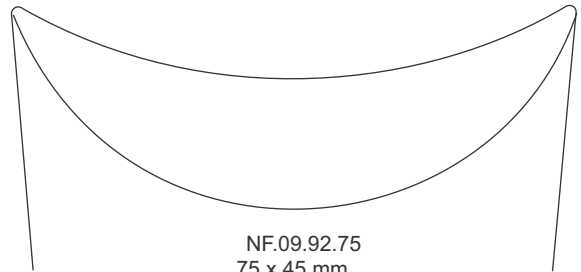

NF.09.92.75  
75 x 45 mm

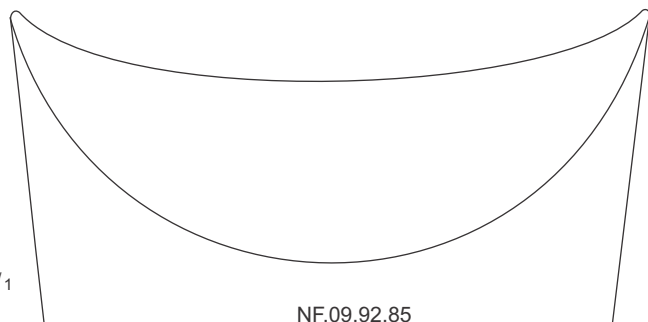

1/1

NF.09.92.85  
85 x 65 mm

# Orthopedic Instruments

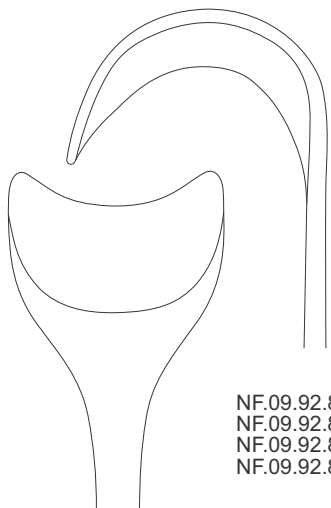

NF.09.92.81 10 x 30 mm  
NF.09.92.82 15 x 30 mm  
NF.09.92.83 20 x 30 mm  
NF.09.92.84 30 x 30 mm

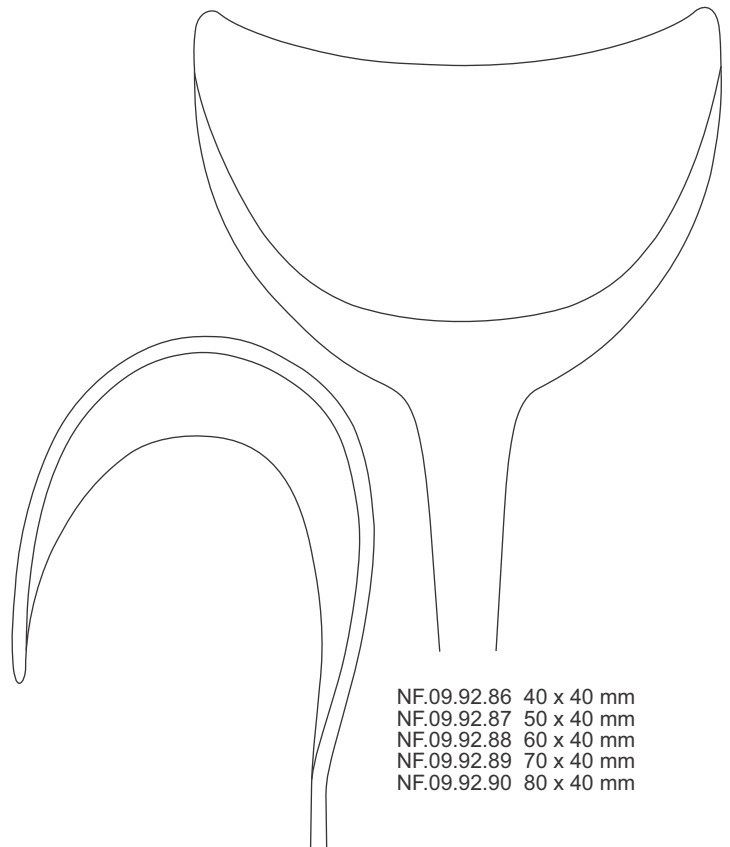

NF.09.92.86 40 x 40 mm  
NF.09.92.87 50 x 40 mm  
NF.09.92.88 60 x 40 mm  
NF.09.92.89 70 x 40 mm  
NF.09.92.90 80 x 40 mm



**FRITSCH (KOCHER)**  
25.5 cm/ 10"

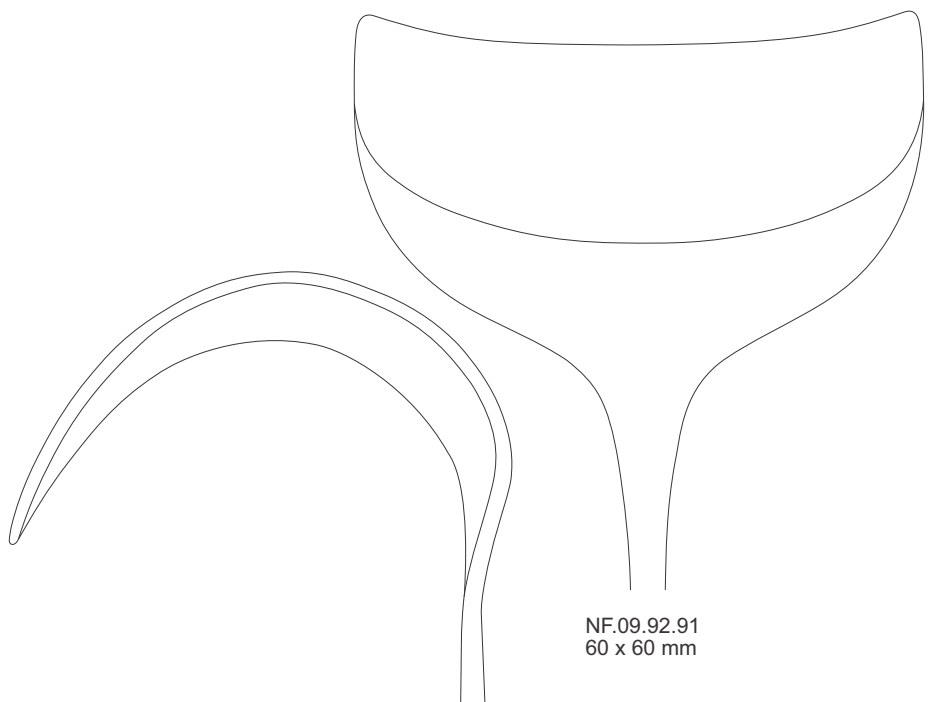

NF.09.92.91  
60 x 60 mm

# Orthopedic Instruments

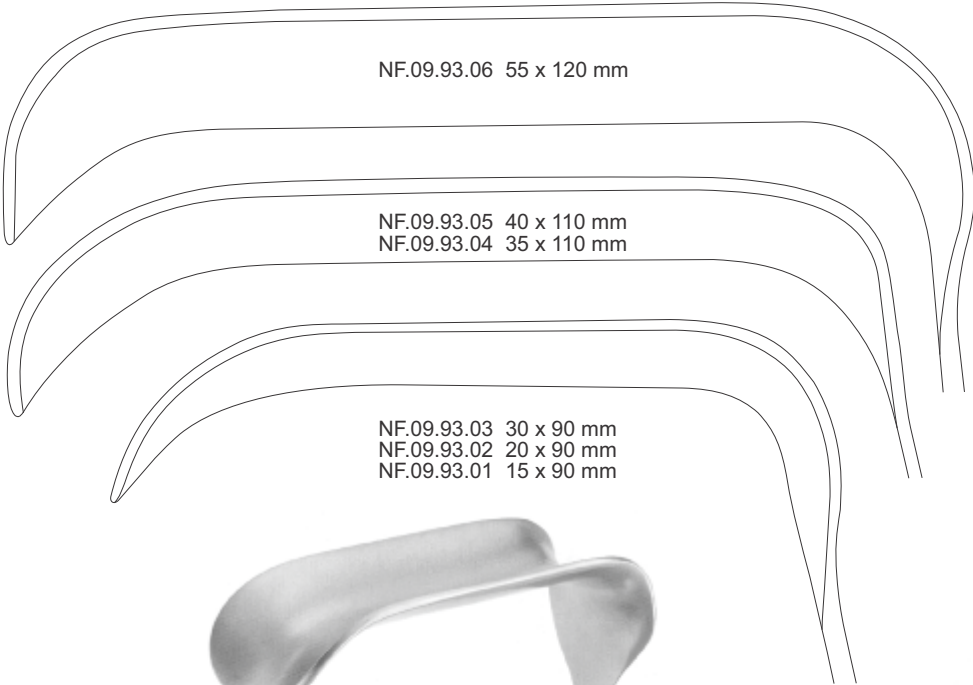

NF.09.93.06 55 x 120 mm

NF.09.93.05 40 x 110 mm  
NF.09.93.04 35 x 110 mm

NF.09.93.03 30 x 90 mm  
NF.09.93.02 20 x 90 mm  
NF.09.93.01 15 x 90 mm



**DOYEN-STILLE**  
24 cm / 9½"

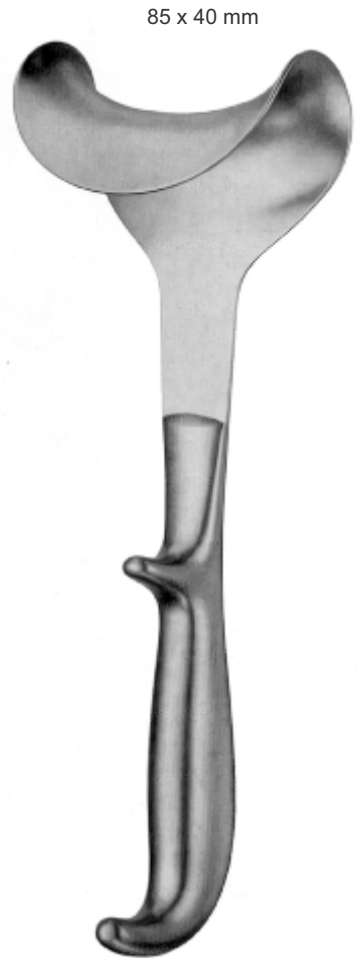

85 x 40 mm

**DOYEN**  
NF.09.94.80  
23 cm / 9"

# Orthopedic Instruments

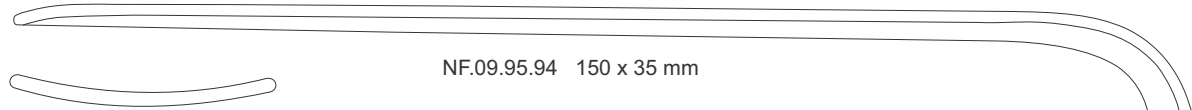

63 x 55 mm

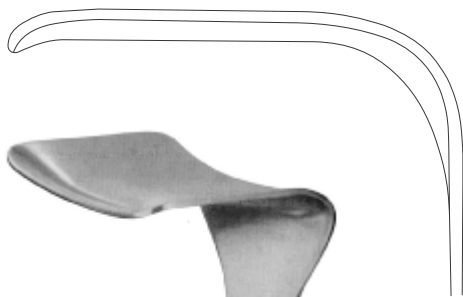

**TUFFIER**  
NF.09.95.90  
23 cm/ 9"

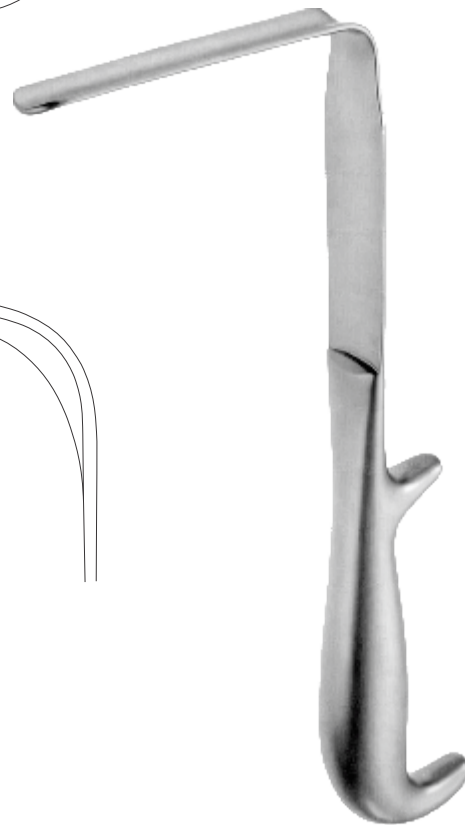

**DOYEN**  
23 cm/ 9"

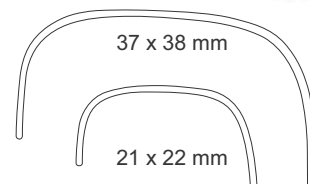

**RICHARDSON-EASTMAN**  
NF.09.96.50

Set complete

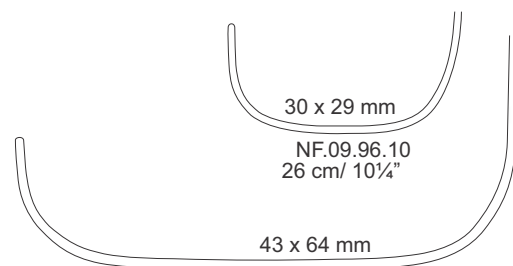

# Orthopedic Instruments



**RICHARDSON**  
24 cm / 9½"

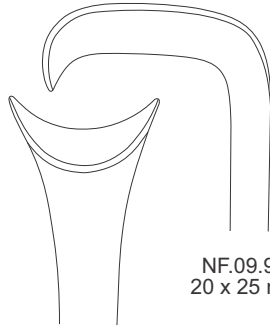

NF.09.97.01  
20 x 25 mm

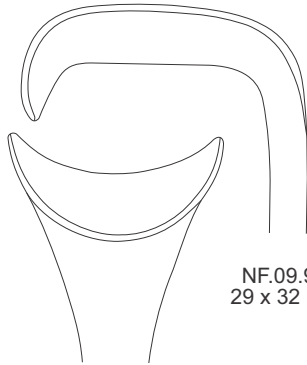

NF.09.97.02  
29 x 32 mm

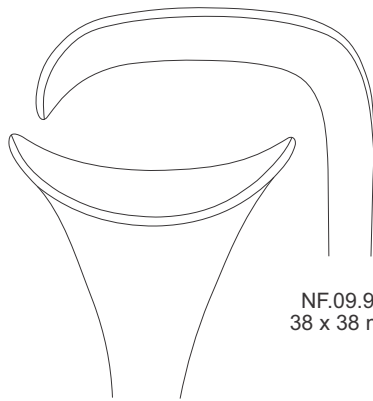

NF.09.97.03  
38 x 38 mm

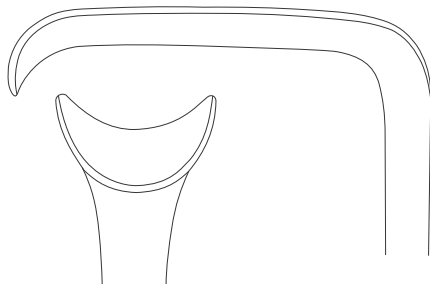

NF.09.97.04  
21 x 48 mm



# Orthopedic Instruments

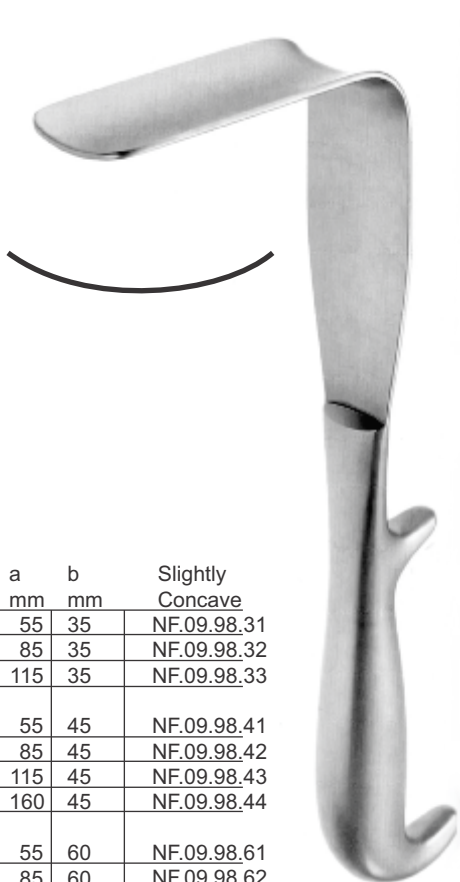
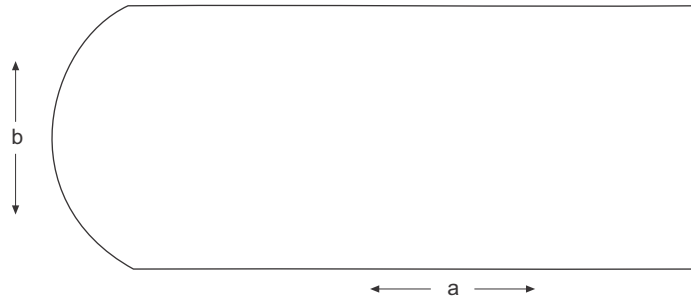

a mm	b mm	Slightly Concave
55	35	NF.09.98.31
85	35	NF.09.98.32
115	35	NF.09.98.33
55	45	NF.09.98.41
85	45	NF.09.98.42
115	45	NF.09.98.43
160	45	NF.09.98.44
55	60	NF.09.98.61
85	60	NF.09.98.62
115	60	NF.09.98.63
160	60	NF.09.98.64

DOYEN  
24 cm/ 9½"

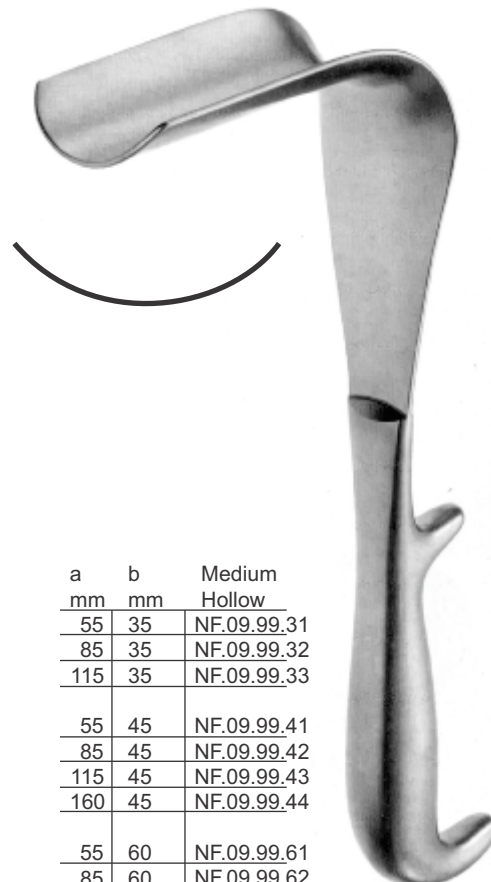

a mm	b mm	Medium Hollow
55	35	NF.09.99.31
85	35	NF.09.99.32
115	35	NF.09.99.33
55	45	NF.09.99.41
85	45	NF.09.99.42
115	45	NF.09.99.43
160	45	NF.09.99.44
55	60	NF.09.99.61
85	60	NF.09.99.62
115	60	NF.09.99.63
160	60	NF.09.99.64

DOYEN  
24 cm/ 9½"

# Orthopedic Instruments



**KELLY**  
26 cm / 10¼"

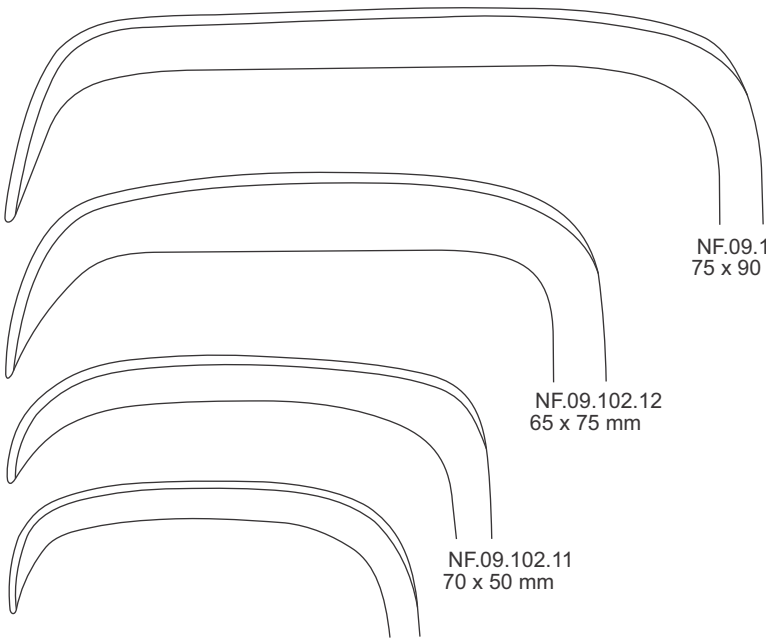

NF.09.102.10  
40 x 50 mm

NF.09.102.11  
70 x 50 mm

NF.09.102.12  
65 x 75 mm

NF.09.102.13  
75 x 90 mm



**SAUERBRUCH**  
NF.09.101.50  
25 cm / 10"



**REHN**  
25 cm / 10"

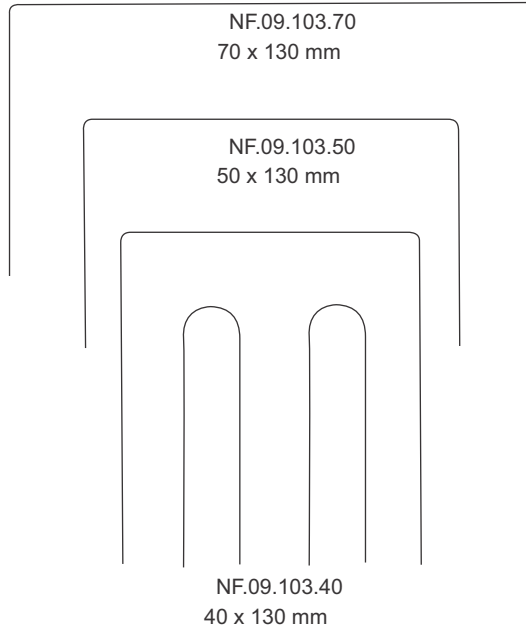

**MEYERDING**

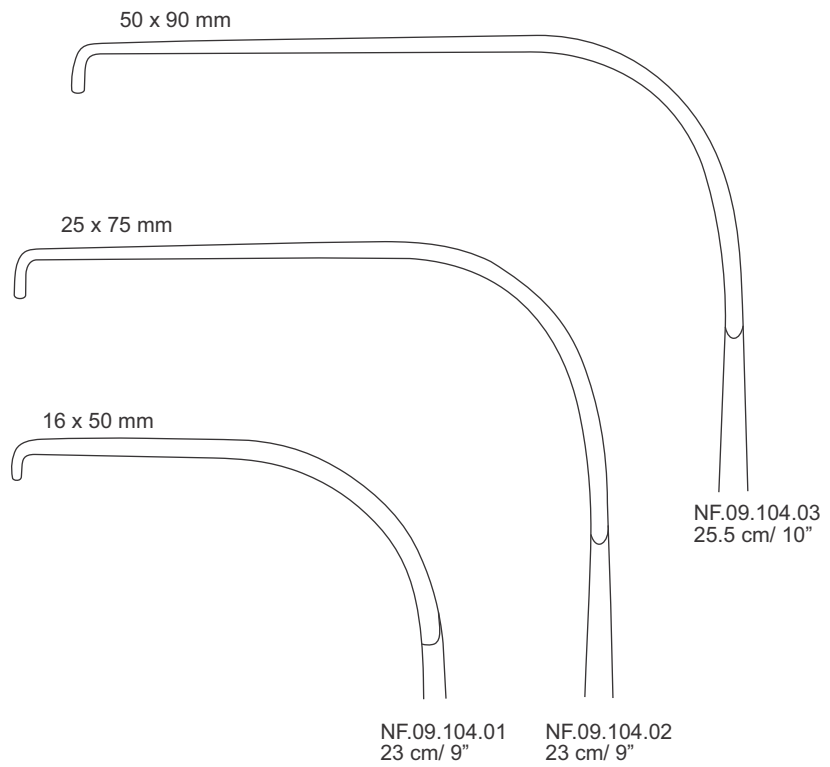

# Orthopedic Instruments

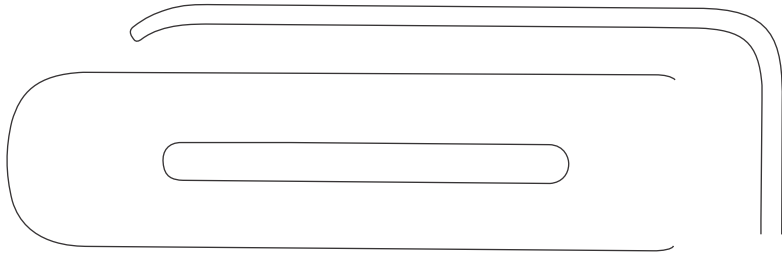

NF.09.105.01  
23 x 85 mm

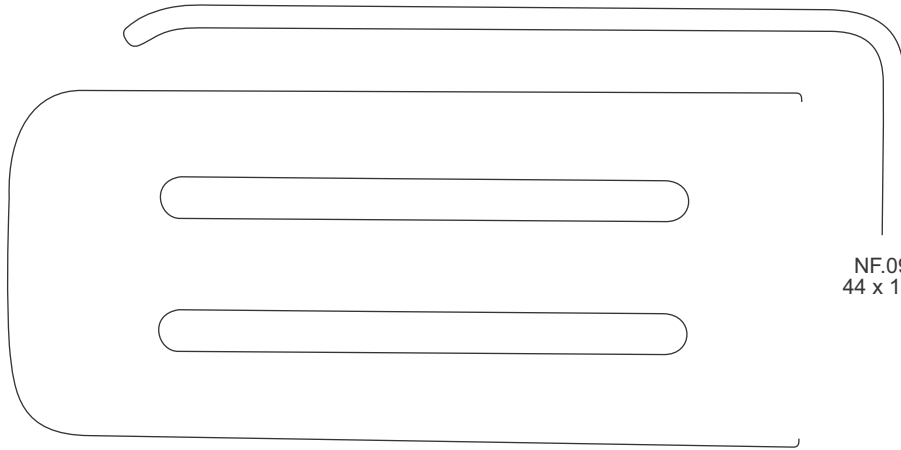

NF.09.106.02  
44 x 105 mm

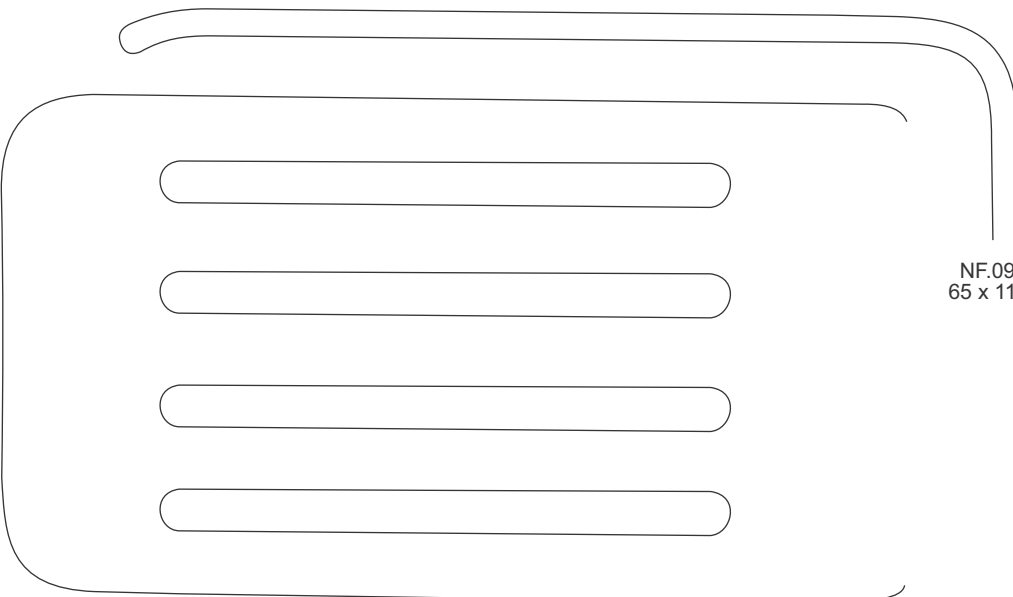

NF.09.107.03  
65 x 115 mm



CORYLLOS  
23 cm/ 9"

# Orthopedic Instruments

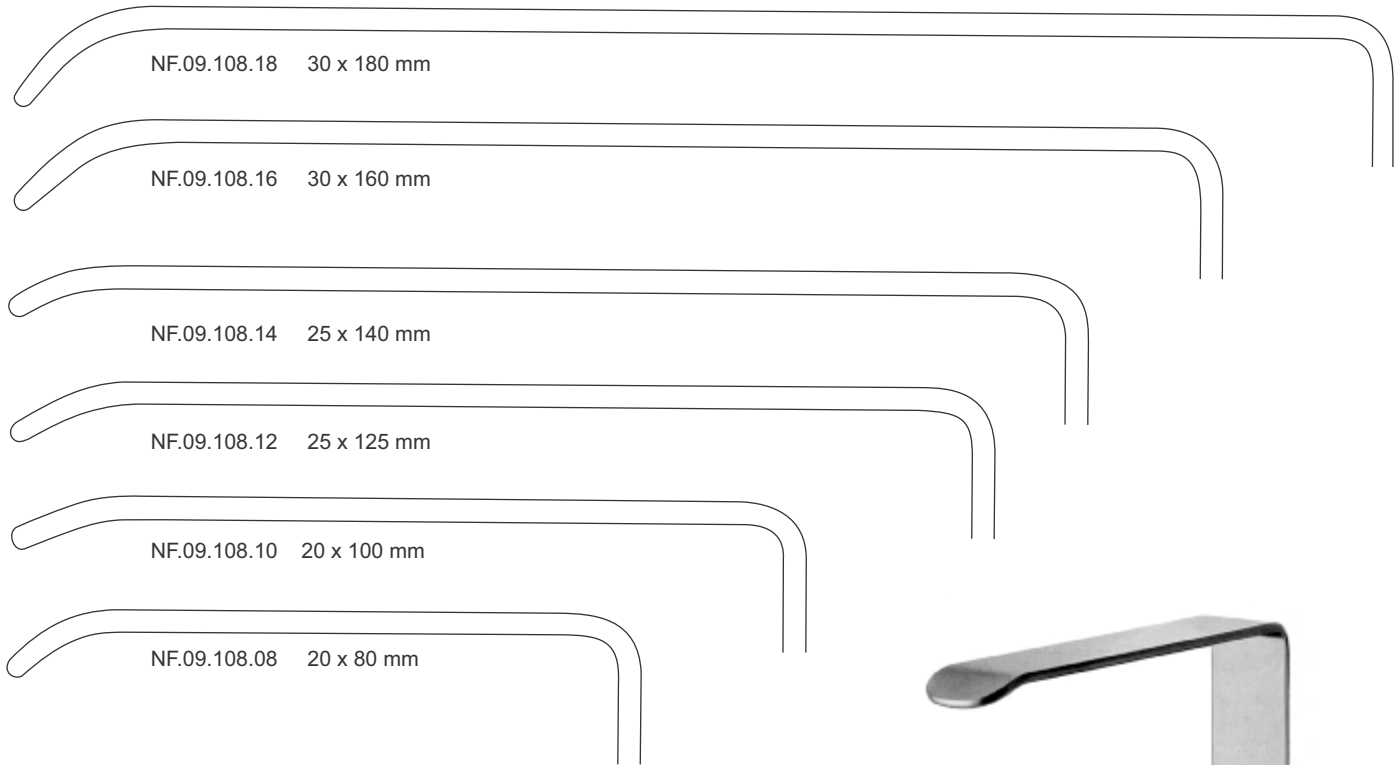

**BRUNNER**  
25 cm/ 10"

# Orthopedic Instruments

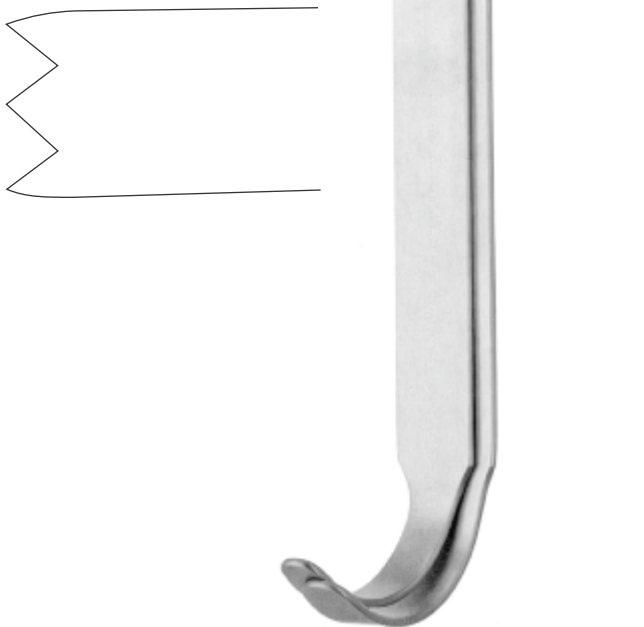
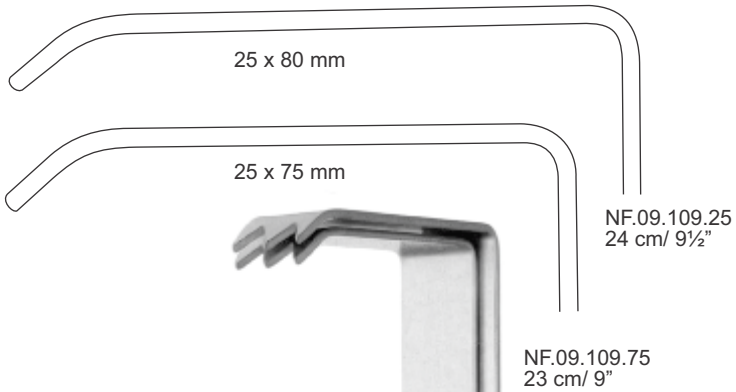

HIBBS  
NF.09.109.80  
Set complete



MIKULICZ  
NF.09.110.25  
25.5 cm / 10"

# Orthopedic Instruments

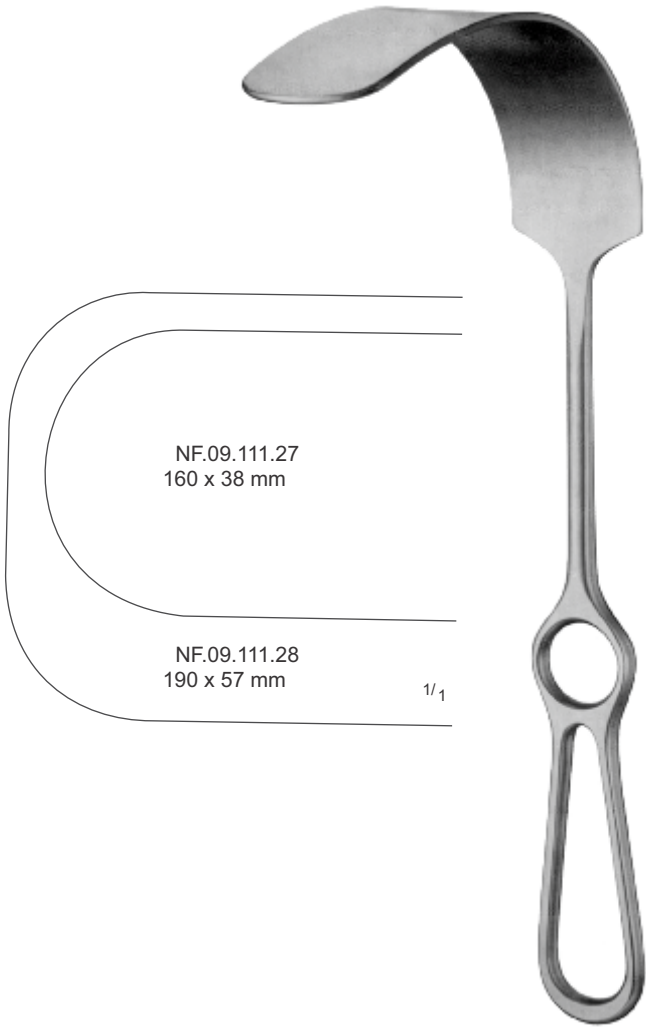
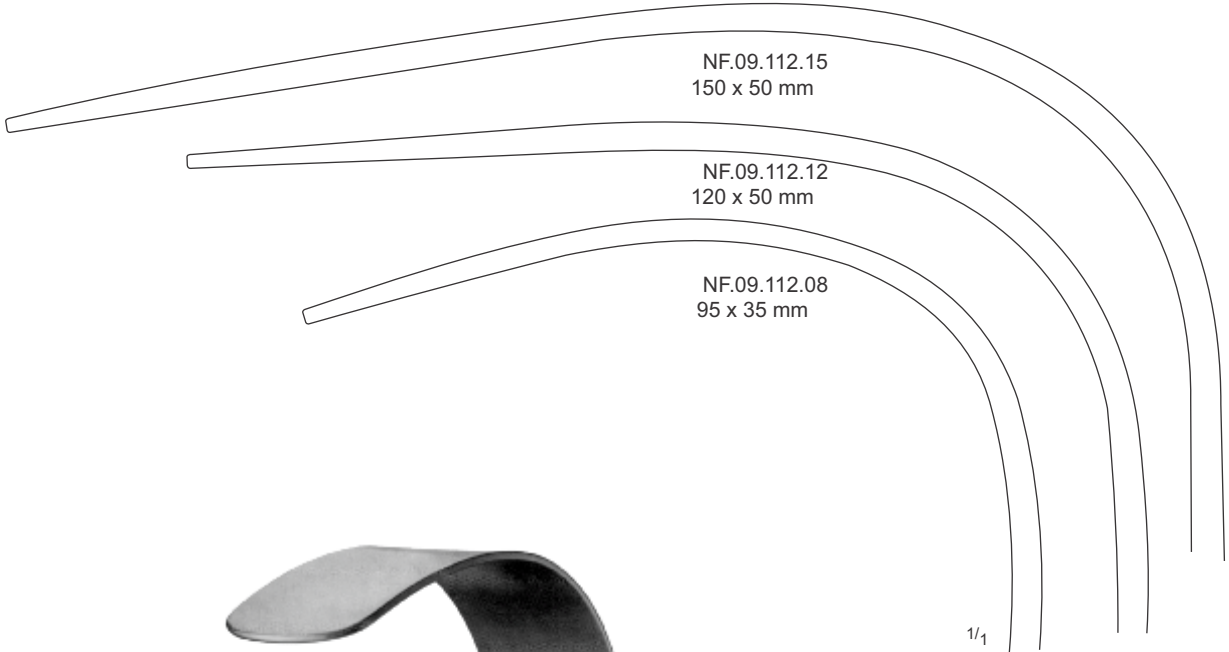

**KELLY**  
NF.09.111.27  
27 cm/ 10<sup>3</sup>/<sub>4</sub>"



**MIKULICZ**  
26 cm/ 10<sup>1</sup>/<sub>4</sub>"

# Orthopedic Instruments

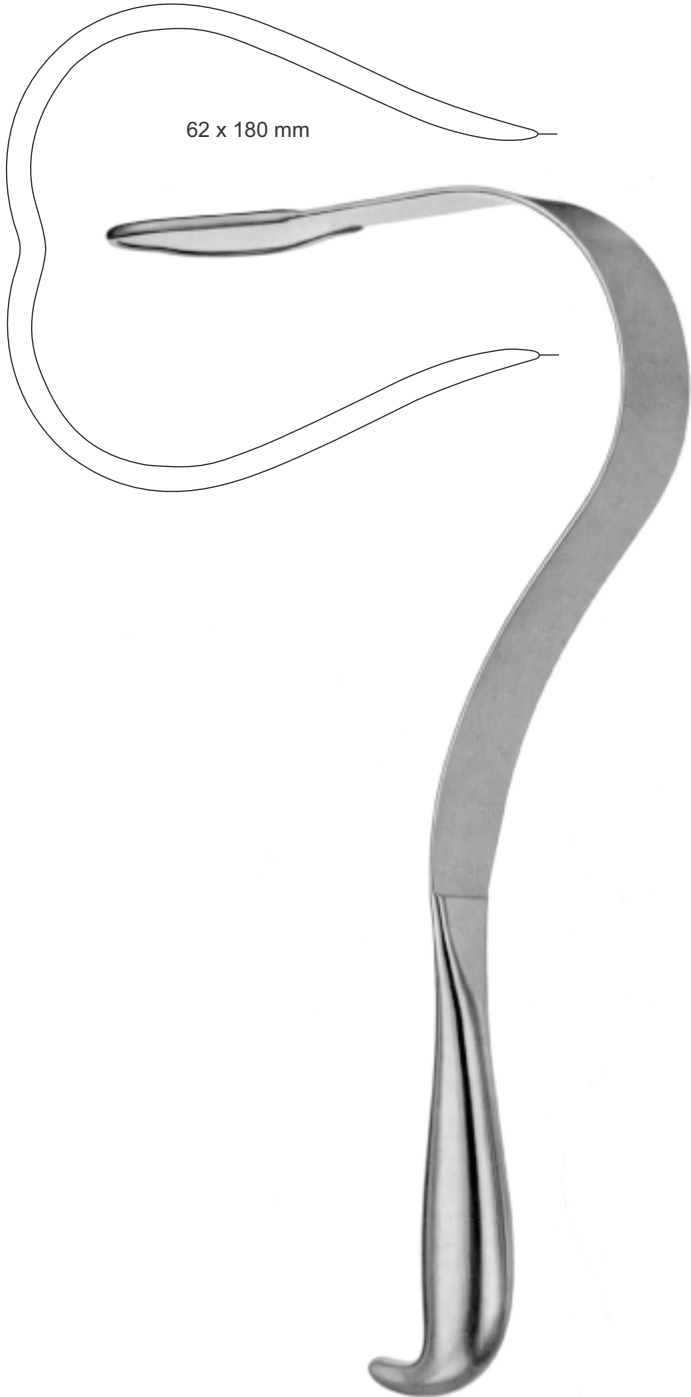

HARRINGTON-PEMBERTON  
NF.09.113.32  
32 cm/ 12½"

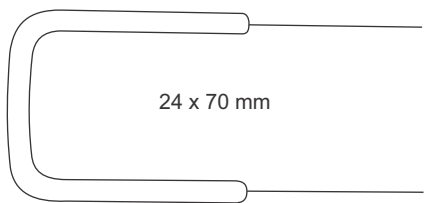

HARRINGTON-BABY  
NF.09.115.24  
27 cm/ 10¾"



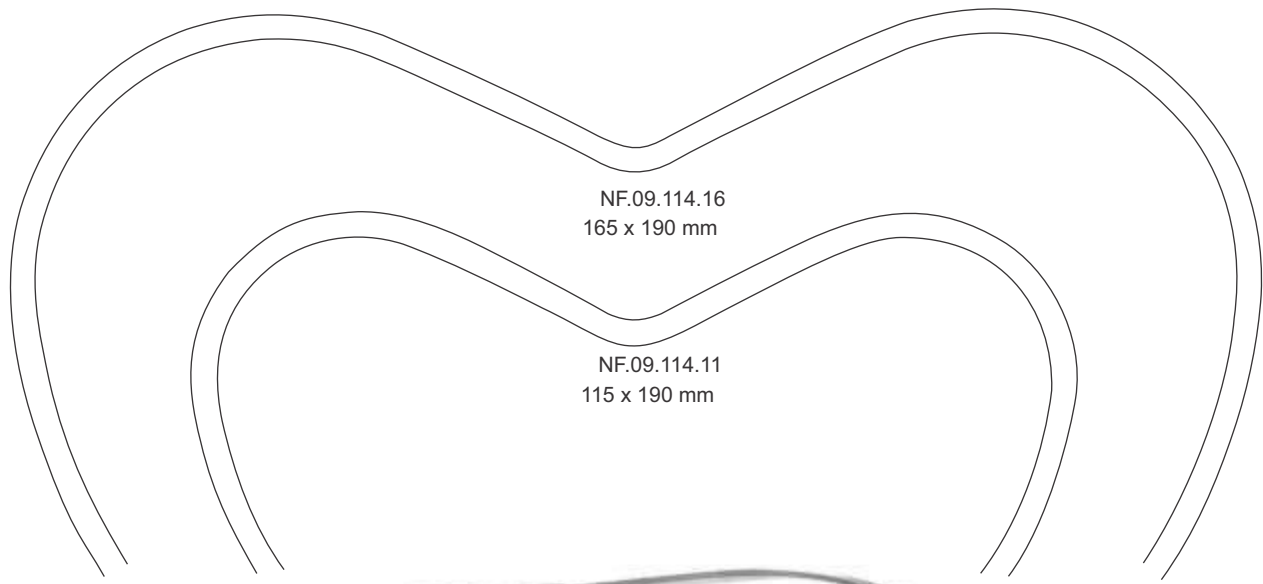

**HARRINGTON**  
32 cm / 12½"

# Orthopedic Instruments

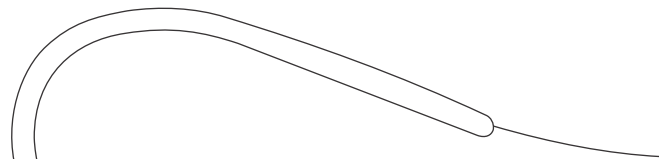

NF.09.116.33  
62 x 127 mm

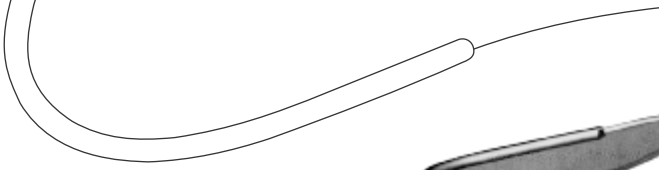

NF.09.116.32  
40 x 127 mm

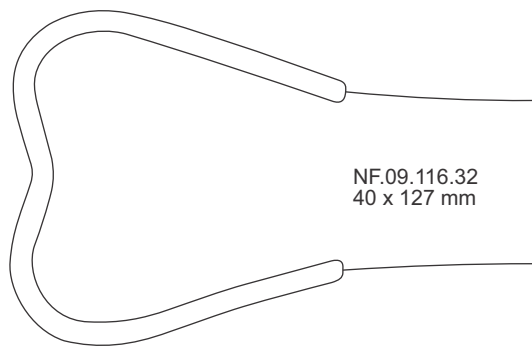

HARRINGTON  
32 cm / 12½"

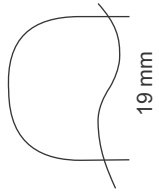

DEAVER  
NF.09.117.01  
# 000  
18 cm / 7⅛"



DEAVER  
NF.09.117.02  
# 00  
22 cm/ 8¾"

DEAVER  
NF.09.117.03  
# 0  
23 cm/ 9"

DEAVER  
NF.09.117.04  
# 1  
30 cm/ 11¼"

DEAVER  
NF.09.117.05  
# 2  
33 cm/ 13"

DEAVER  
NF.09.118.02  
# 2½  
35 cm/ 13¾"

# Orthopedic Instruments

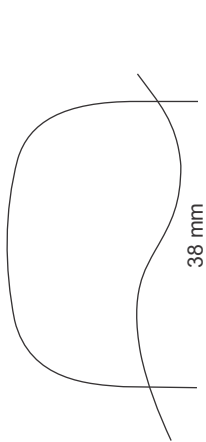

DEAVER  
NF.09.118.03  
# 3  
30 cm/ 11<sup>3</sup>/<sub>4</sub>"

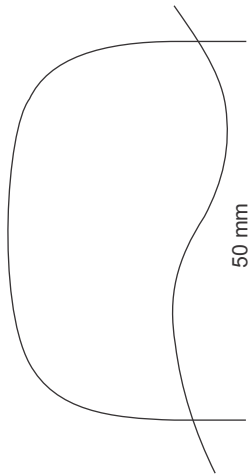

DEAVER  
NF.09.118.04  
# 4  
30 cm/ 11<sup>3</sup>/<sub>4</sub>"

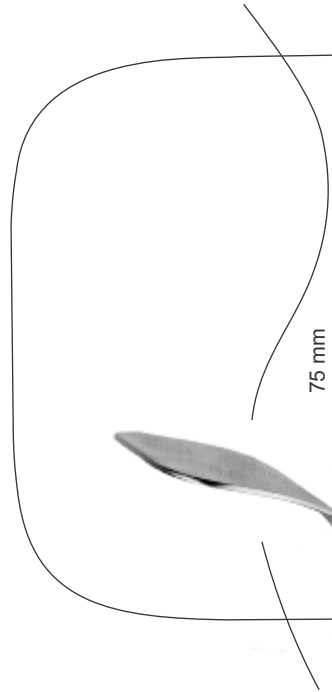

DEAVER  
NF.09.118.05  
# 5  
30 cm/ 11<sup>3</sup>/<sub>4</sub>"

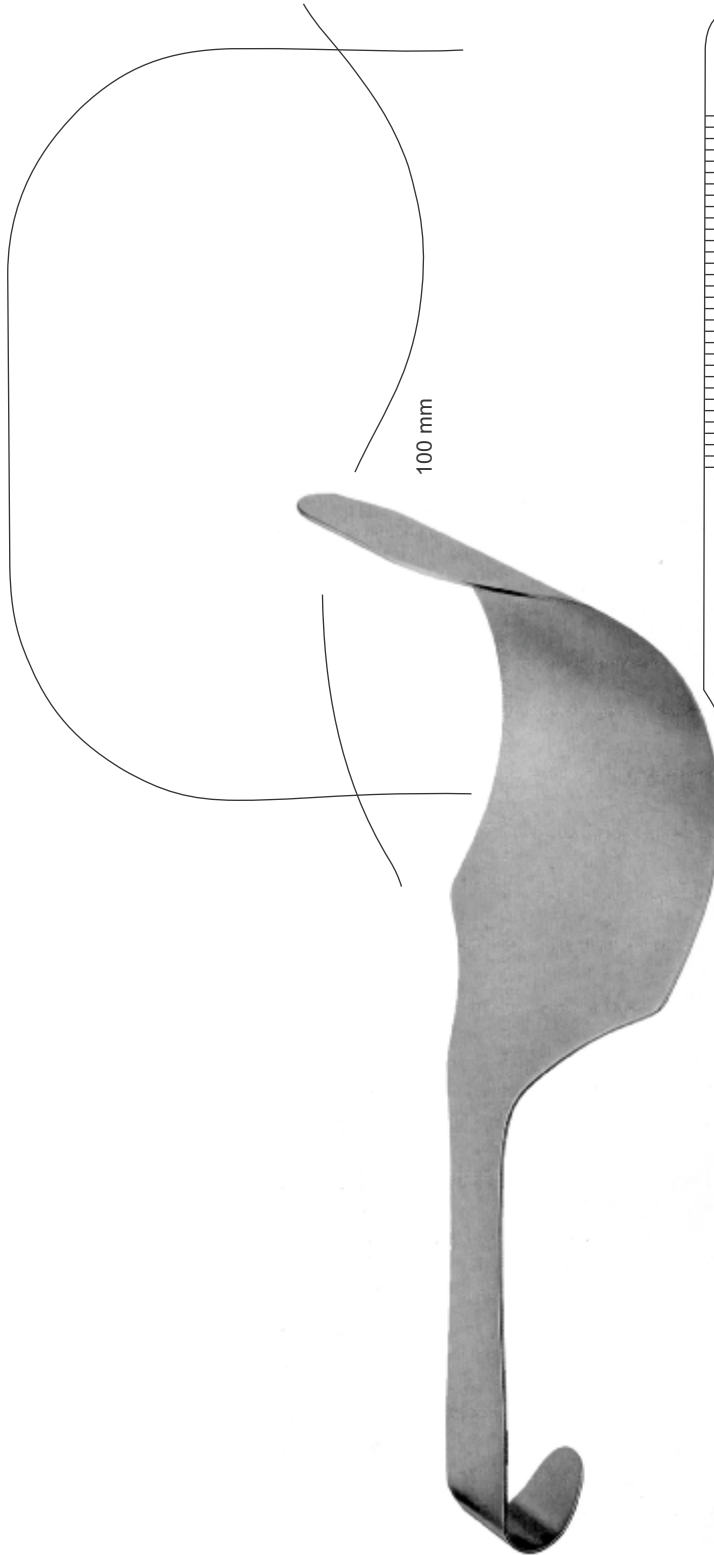

100 mm

DEAVER  
NF.09.118.06  
# 6  
30 cm/ 11¼"

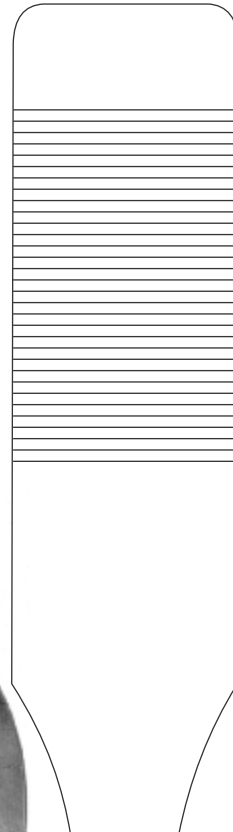

NF.09.119.03  
30 mm

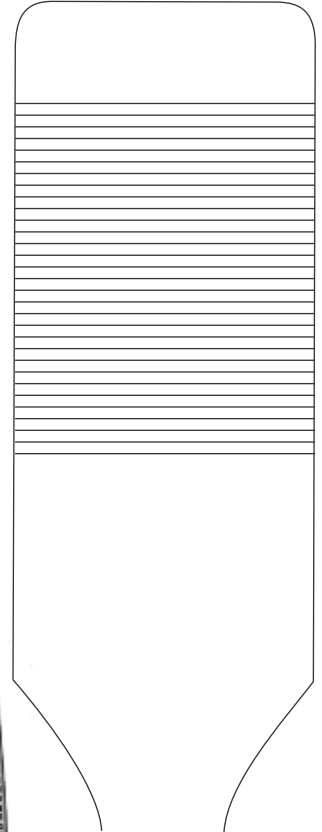

NF.09.119.04  
40 mm

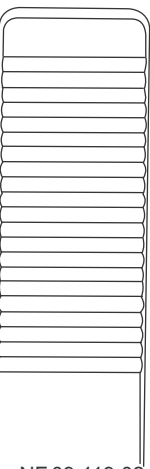

NF.09.119.02  
20 mm

KADER  
27 cm/ 10¾"

# Orthopedic Instruments

30 x 100 mm



MIKULICZ  
NF.09.120.26  
25.5 cm/ 10"



45 x 120 mm

KUEMMEL  
NF.09.121.33  
33 cm/ 33"



NF.09.123.10  
100 cc



DEAVER-BABY  
20 cm/ 8"

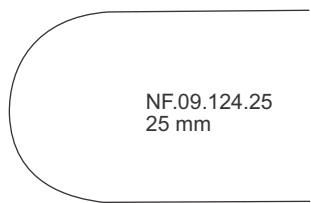

NF.09.124.25  
25 mm

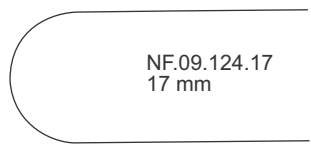

NF.09.124.17  
17 mm

# Orthopedic Instruments

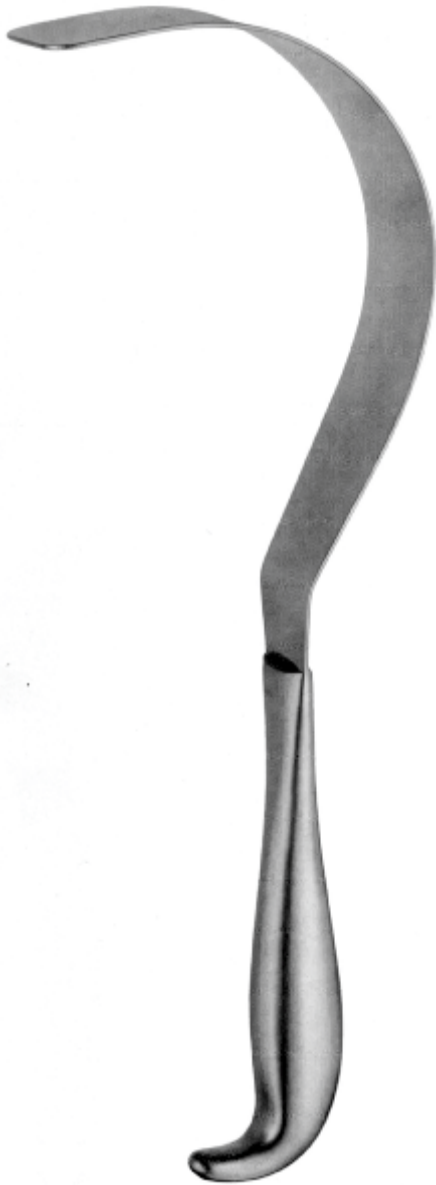

DEAVER  
32 cm / 12½"

NF.09.125.25  
25 mm

NF.09.125.35  
35 mm

NF.09.125.50  
50 mm

NF.09.125.75  
75 mm

# Self-retaining Retractors





# Self-retaining Retractors

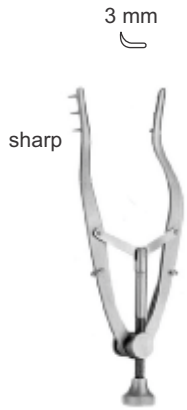

STEVENSON  
NF.09.01.75  
7.5 cm / 2¾"



AGRICOLA  
NF.09.02.04  
4 cm / 1½"

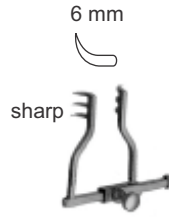

LOGAN (GOLDSTEIN)  
NF.09.03.35  
3.5 cm / 1⅜"



JANSEN  
NF.09.04.10  
10 cm / 4"



JANSEN  
NF.09.05.20  
10 cm / 4"



JANSEN  
NF.09.06.21  
12 cm / 4¾"



WEITLANER  
3 x 4 Prongs  
NF.09.07.13 13 cm / 5⅞" Sharp  
NF.09.07.14 13 cm / 5⅞" Blunt  
NF.09.07.16 16.5 cm / 6½" Sharp  
NF.09.07.17 16.5 cm / 6½" Blunt

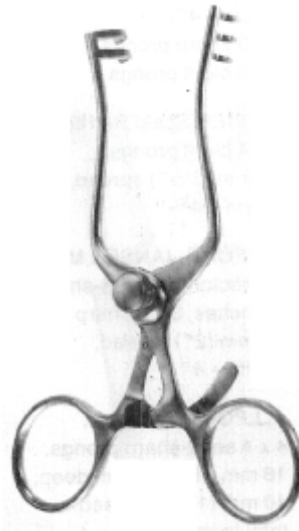

WEITLANER  
2 x 3 Prongs  
NF.09.08.10 10.5 cm / 4⅞" Sharp  
NF.09.08.11 10.5 cm / 4⅞" Blunt

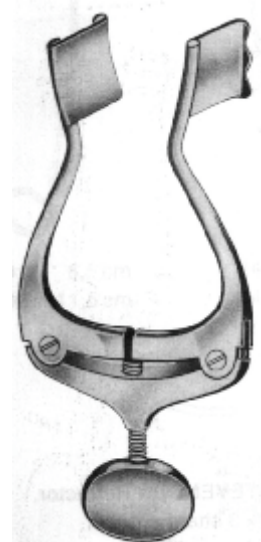

MASTOID  
NF.09.09.11  
11 cm / 4¼"

# Self-retaining Retractors



**GIFFORD-JANSEN**  
NF.09.10.10  
10 cm/ 4"  
3 x 3 prongs Sharp



**ALLPORT**  
NF.09.11.10  
10 cm/ 4"  
4 x 4 prongs Semi-Sharp



**SHAMBAUGH**  
NF.09.12.11  
11 cm/ 4¼"

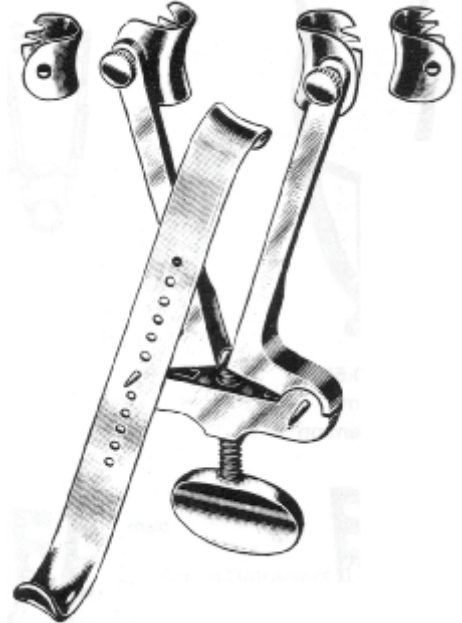

**HENNER (LEMPERT)**  
NF.09.13.12 Without center blade  
NF.09.13.13 With center blade  
12 cm/ 4¾"



sharp

NF.09.14.01 8.5 cm/ 3⅝"  
NF.09.14.02 11.5 cm/ 4½"



NF.09.15.03 8.5 cm/ 3⅝"  
NF.09.15.04 11.5 cm/ 4½"



sharp

NF.09.16.52  
10.5 cm/ 4⅛"



12 mm



sharp  
NF.09.17.05

**FINSEN**  
5 cm/ 2"



12 mm



sharp  
NF.09.18.0

**FINSEN**  
7 cm/ 2¾"



12 mm



sharp  
NF.09.19.07

**FINSEN**  
7 cm/ 2¾"

blunt  
NF.09.18.08

blunt  
NF.09.19.08

# Self-retaining Retractors

6 mm



NF.09.23.09 sharp

NF.09.23.10 blunt

10 cm / 4"

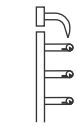

NF.09.24.07 sharp



NF.09.24.08 blunt



ALM  
7 cm / 2¾"

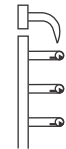

NF.09.25.10 sharp



ALM  
10 cm / 4"

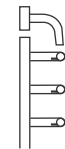

NF.09.25.11 blunt

20 mm



NF.09.20.20 sharp

NF.09.20.21 blunt

WEITLANER  
20 cm / 8"

25 mm

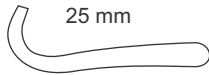

NF.09.21.24 sharp

NF.09.21.25 blunt

WEITLANER  
24 cm / 9½"

25 mm

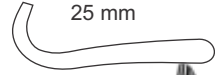

NF.09.22.24 sharp

NF.09.22.27 blunt

WEITLANER  
25.5 cm / 10"

# Self-retaining Retractors

18 mm

**WEITLANER**  
NF.09.26.13  
13 cm / 5 1/8"

15 mm

NF.09.27.10 sharp  
NF.09.28.11 blunt  
NF.09.28.12 semi sharp

**WEITLANER**  
10.5 cm / 4 1/8"

16 mm

NF.09.29.13 sharp  
NF.09.30.13 blunt  
NF.09.30.14 semi sharp

**WEITLANER**  
13 cm / 5 1/8"

16 mm

NF.09.29.16 sharp  
NF.09.30.16 blunt  
NF.09.30.17 semi sharp

**WEITLANER**  
16 cm / 6 1/2"

17 mm

**SCHUKNECHT**  
NF.09.31.13  
13 cm / 5 1/8"

20 mm

**SCHUKNECHT**  
NF.09.32.13  
13 cm / 5 1/8"

# Self-retaining Retractors



**BELLUCCI**  
NF.09.32.01  
11 cm/ 4<sup>3</sup>/<sub>8</sub>"



**BELLUCCI**  
NF.09.32.02  
11 cm/ 4<sup>3</sup>/<sub>8</sub>"



**FISH**  
NF.09.31.12  
13 cm/ 5<sup>1</sup>/<sub>8</sub>"

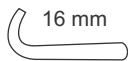

**PLESTER**  
NF.09.31.21  
11 cm/ 4<sup>3</sup>/<sub>8</sub>"

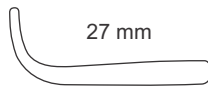

**PLESTER**  
NF.09.31.22  
12 cm/ 4<sup>3</sup>/<sub>4</sub>"

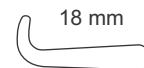

**WEITLANER-WULLSTEIN**  
13 cm/ 5<sup>1</sup>/<sub>8</sub>"

# Self-retaining Retractors

20 mm



SCHUKNECHT  
NF.09.31.18  
13 cm/ 5 1/8"

14 mm



sharp

MOLLISON  
NF.09.31.30  
17 cm/ 6 3/4"

18 mm

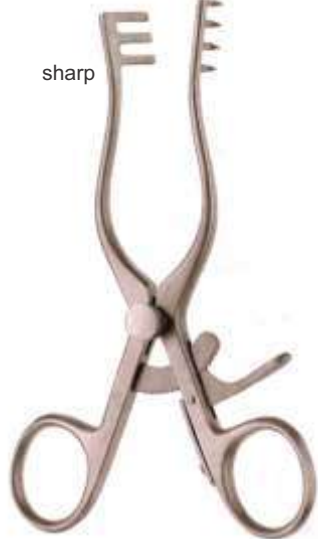

sharp

WEST  
NF.09.31.35  
14 cm/ 5 1/2"

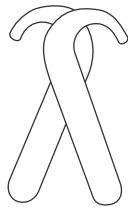

25 mm



NF.09.33.20  
sharp

NF.09.33.21  
blunt

ADSON  
20 cm/ 8"

24 mm



sharp

ADSON-ANDERSON  
NF.09.34.19  
19 cm/ 7 1/2"

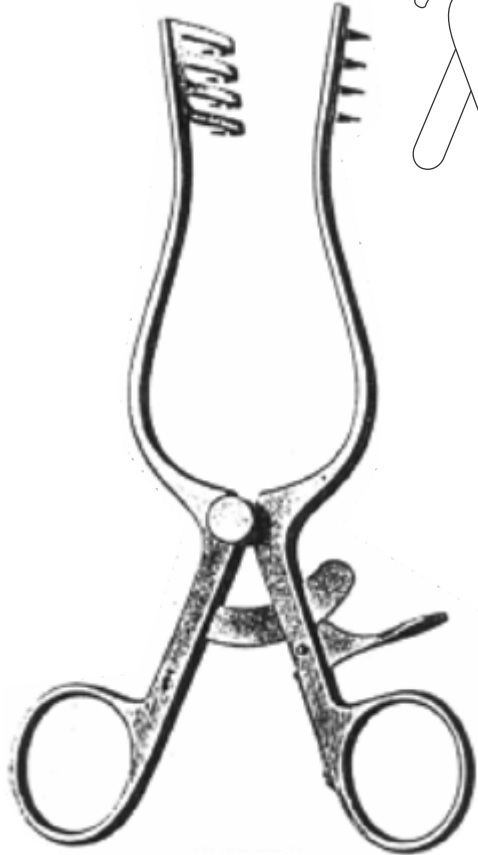

17.5 cm/ 7"

# Self-retaining Retractors

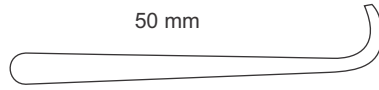

CONTOUR  
NF.09.36.14  
14 cm / 5½"

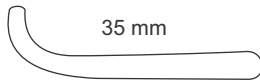

sharp



MISKIMON  
NF.09.35.22  
22 cm / 8¾"



NORFOLK-NORWICH  
NF.09.35.44  
22 cm / 8¾"

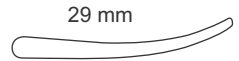
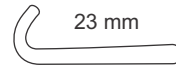

NF.09.30.30  
18 cm / 7⅞"

# Self-retaining Retractors

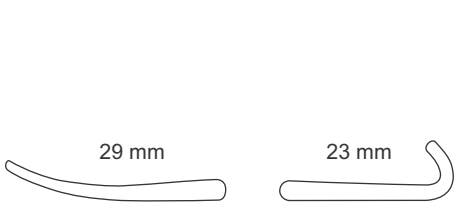

NF.09.30.31  
18 cm / 7 1/8"

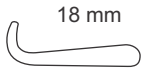

WEITLANER-BECKMANN  
14.5 cm / 5 3/4"



TRAVERS  
NF.09.37.22  
21.5 cm / 8 1/2"

NF.09.37.13  
sharp

NF.09.37.14  
blunt



# Self-retaining Retractors

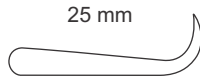

3 x 4 prongs



ADSON  
Retractor  
26.5 cm/ 10½"  
NF.10.38.26 sharp  
NF.10.38.27 blunt

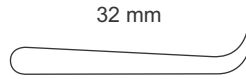

6 x 6 sharp prongs



ADSON  
Hemilaminectomy  
Retractor  
26.5 cm/ 10½"  
NF.10.38.36

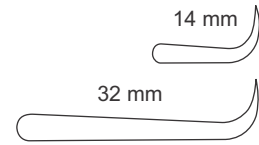

6 x 6 blunt prongs



ADSON  
Hemilaminectomy  
Retractor  
26.5 cm/ 10½"  
NF.10.38.37  
left 14 mm  
right 32 mm

# Self-retaining Retractors



1/2  
ADSON  
3 x 4 teeth

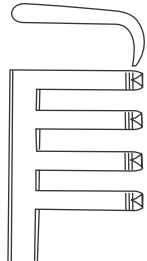

NF.10.39.13  
sharp  
13 cm - 5"

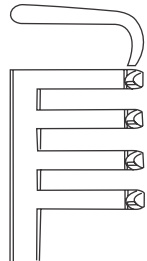

NF.10.39.14  
blunt  
13 cm - 5"

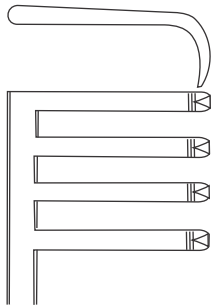

NF.10.39.26  
sharp  
26 cm - 10 1/4"

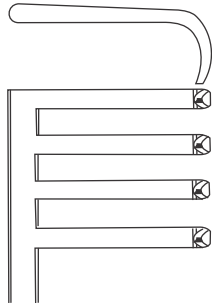

NF.10.39.27  
blunt  
26 cm - 10 1/4"

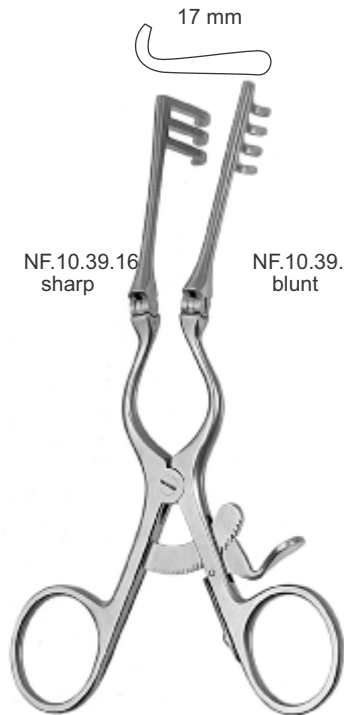

NF.10.39.16  
sharp

NF.10.39.17  
blunt

WEITLANER-BECKMANN  
17 cm/ 6 3/4"



NF.10.39.20  
sharp

NF.10.39.21  
blunt

WEITLANER-BECKMANN  
22 cm/ 8 3/4"

# Self-retaining Retractors



23 mm



28 mm

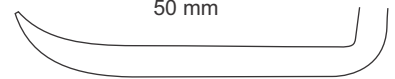

50 mm



sharp

BECKMANN  
NF.10.40.31  
31 cm / 12 $\frac{1}{8}$ "



blunt

ADSON  
NF.10.40.32  
32.5 cm / 12 $\frac{3}{4}$ "



sharp

BECKMANN-EATON  
NF.10.40.62  
32 cm / 12 $\frac{1}{2}$ "

# Self-retaining Retractors



BECKMANN-ADSON  
31 cm / 12 1/4"  
4 x 4 teeth

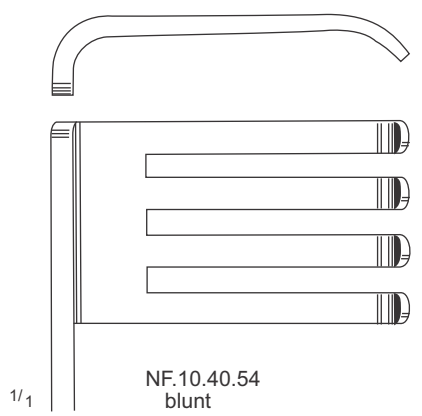
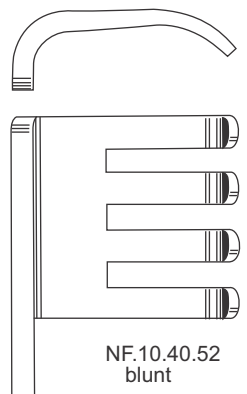
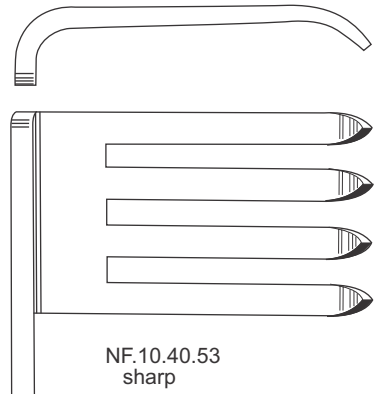
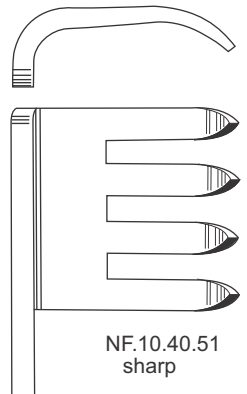

# Self-retaining Retractors

sharp prongs



**KOCHER**  
NF.10.41.16  
16 cm/ 6¼"

sharp prongs



**CROTTI**  
NF.10.42.18  
18 cm/ 7"



**GELPI BABY**  
NF.10.43.10  
10 cm/ 4"

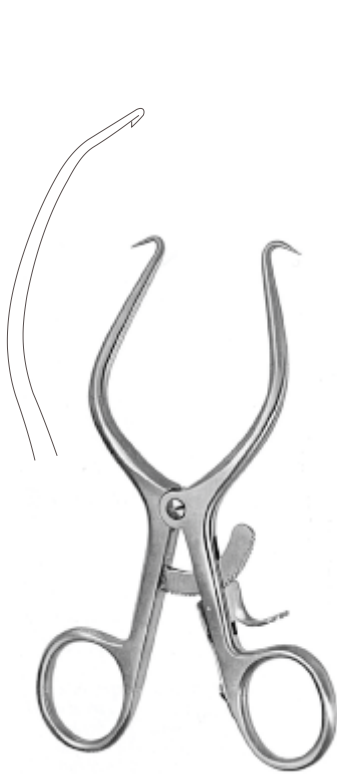

**GELPI-BABY**  
PY-43.14  
14 cm/ 5½"



**GELPI**  
PY-44.17  
17 cm/ 6¾"



**GELPI**  
PY-45.17  
19 cm/ 7½"

# Self-retaining Retractors



RIGBY  
PY-46.18  
18 cm / 7 1/8"



Lateral blade  
16 x 30 mm

MAYO-ADAMS  
PY-47.17  
17 cm / 6 3/4"

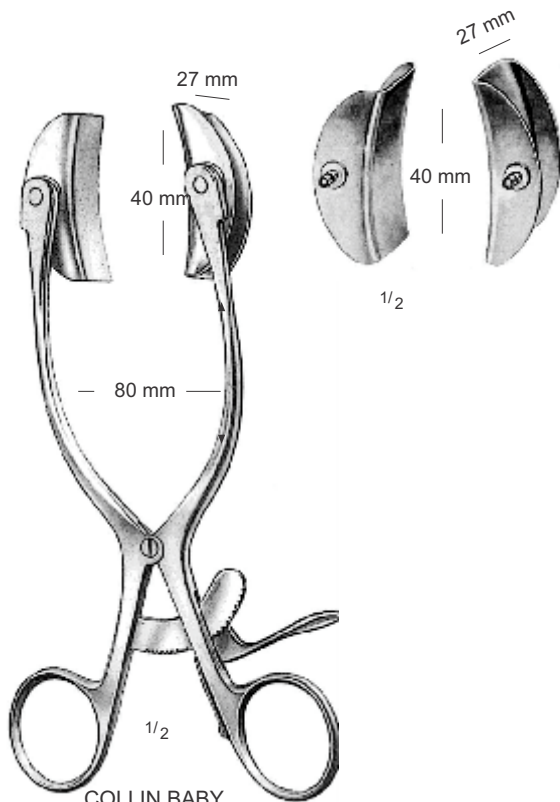

COLLIN BABY  
NF.10.48.00  
complete with two pair of blades



MAYO-ADAMS  
PY-47.18  
17 cm / 6 3/4"

# Self-retaining Retractors



MARKHAM-MEYERDING  
NF.10.49.18  
18 cm / 7 1/8"



MARKHAM-MEYERDING  
NF.10.50.18  
18 cm / 7 1/8"



DARTIGUES  
NF.10.51.65  
24 cm / 9 1/2"

max. spread 110 mm



NF.10.52.16  
40 x 18 mm  
Lateral Blades only (Pair)

max. spread 80 mm

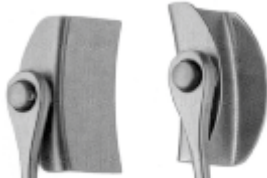

NF.10.52.28  
40 x 28 mm  
Lateral Blades only (Pair)



COLLIN-BABY  
NF.10.52.07  
18 cm / 7 1/8"

NF.10.52.18  
Frame only



NF.10.48.62  
62 x 38 mm  
Lateral Blades only (Pair)



COLLIN  
NF.10.48.24  
23.5 cm / 9 1/4"

NF.10.48.23  
Frame only

# Self-retaining Retractors

max. spread 110 mm



NF.10.55.36  
Frame only

NF.10.55.38 62 x 38 mm  
NF.10.54.39 80 x 38 mm  
NF.10.55.39 100 x 38 mm  
Lateral blades only (Pair)

NF.10.55.40 55 x 40 mm  
NF.10.55.56 65 x 55 mm  
NF.10.55.58 75 x 55 mm  
Center blade only

**COLLIN**  
23.5 cm / 9 1/4"

- |                 |                 |                 |
|-----------------|-----------------|-----------------|
| NF.10.54.00     | NF.10.54.01     | NF.10.54.02     |
| 1 x NF.10.55.38 | 1 x NF.10.54.39 | 1 x NF.10.55.39 |
| 1 x NF.10.55.40 | 1 x NF.10.55.56 | 1 x NF.10.55.58 |
| 1 x NF.10.55.36 | 1 x NF.10.55.36 | 1 x NF.10.55.36 |



**MEYERDUNG**  
18 cm / 7"  
NF.10.53.30 25 x 30 mm  
NF.10.53.55 25 x 55 mm  
NF.10.53.60 25 x 60 mm  
NF.10.53.61 20 x 60 mm



# Self-retaining Retractors



max. spread 150 mm

NF.10.54.50  
65 x 50 mm  
center blade only

OETTINGEN  
NF.10.54.70

# Self-retaining Retractors

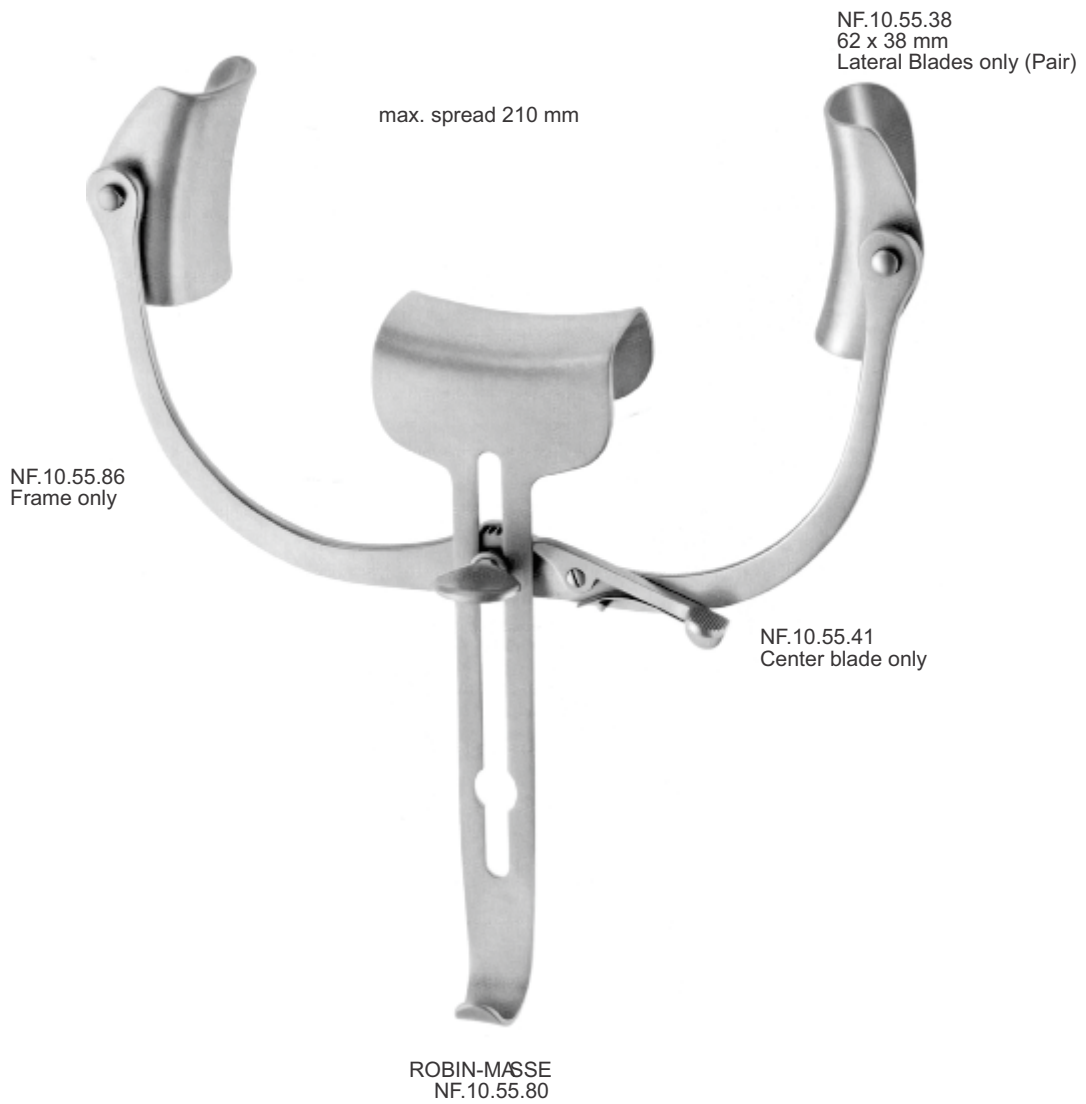

# Self-retaining Retractors



max. spread 165 mm

NF.10.56.60 58 x 50 mm  
NF.10.56.62 80 x 62 mm  
Lateral Blades only (Pair)

NF.10.56.56  
Frame only

NF.10.56.70  
Center blade only

COLLIN  
NF.10.56.50  
32 cm/ 12½"

NF.10.56.51  
33 cm/ 13"

# Self-retaining Retractors



NF.10.57.09  
Frazier



NF.10.58.12  
Temple-Fay

# Self-retaining Retractors

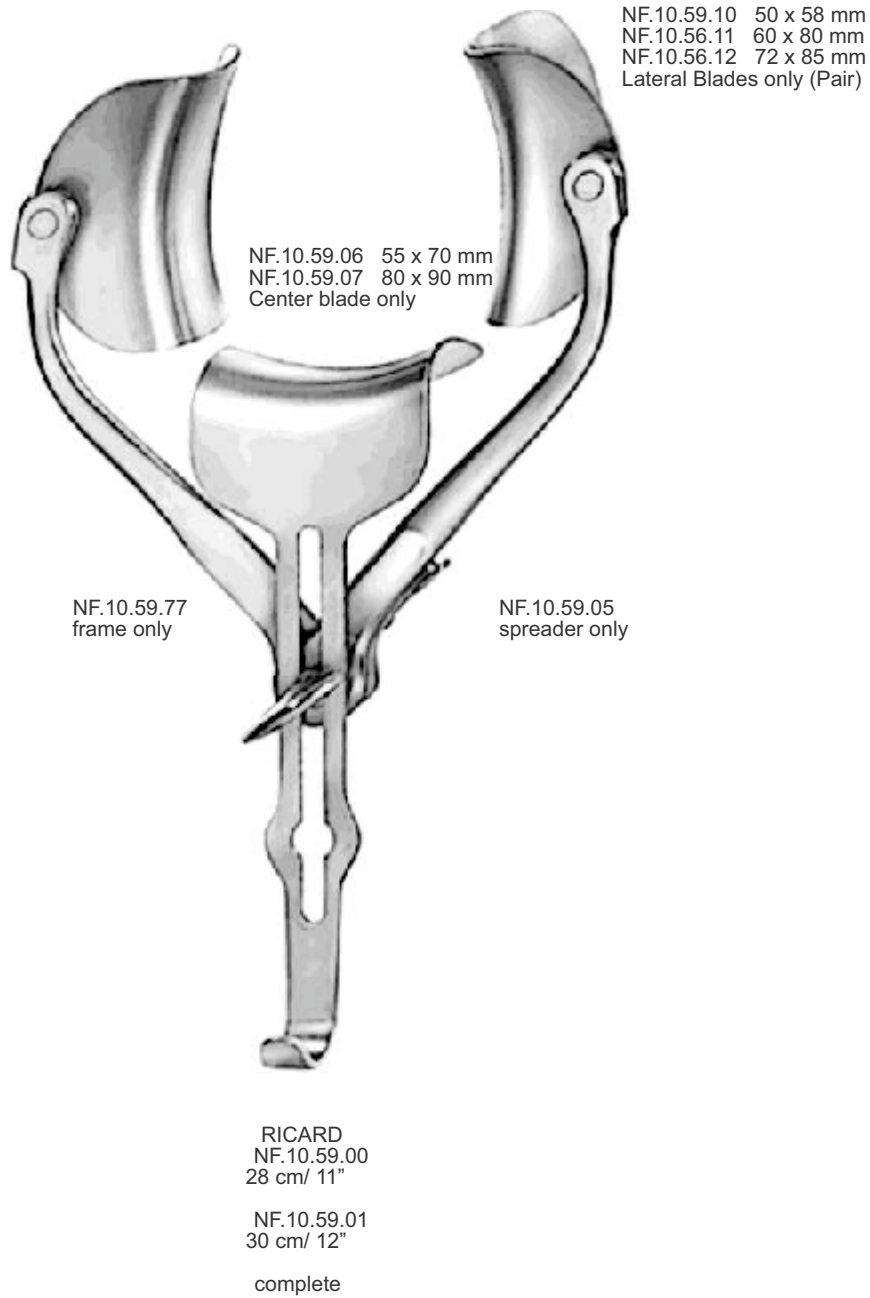

# Self-retaining Retractors

max. spread 115 mm

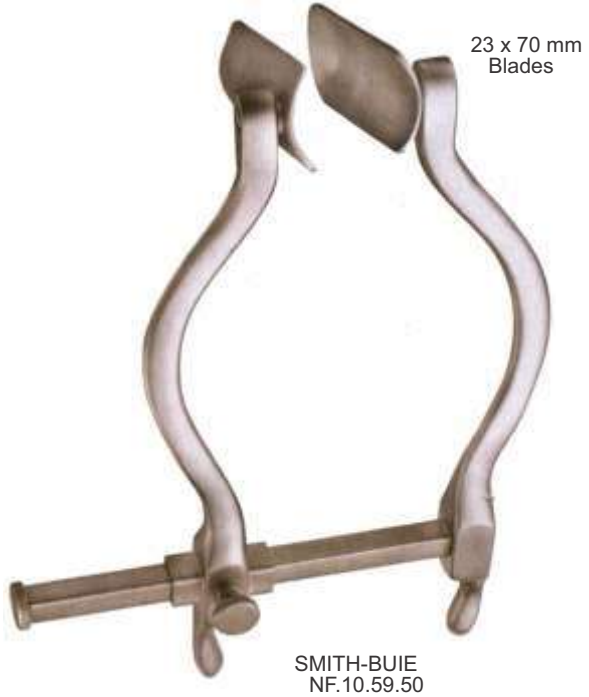

NF.10.60.10  
max. spread 105 mm  
Lateral blades 18 mm



NF.10.60.11  
max. spread 115 mm  
Lateral blades 25 mm

max. spread 80 mm



# Self-retaining Retractors

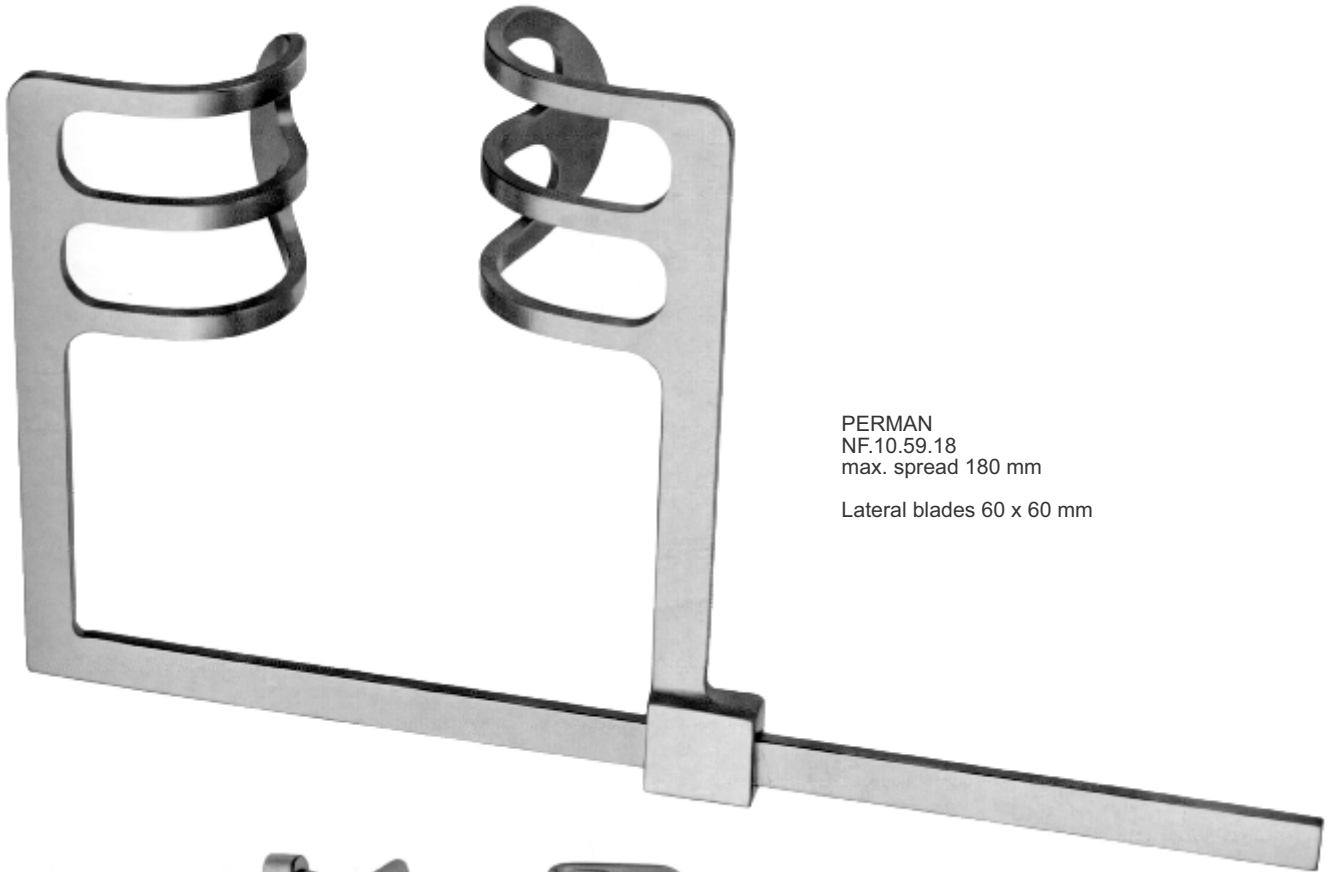

PERMAN  
NF.10.59.18  
max. spread 180 mm

Lateral blades 60 x 60 mm



GOSSET  
NF.10.61.15  
max. spread 115 mm

Lateral blades 55 mm

# Self-retaining Retractors



NF.10.62.21  
Center blade 57 x 60 mm

**GOSSET**  
NF.10.62.57  
max. spread 160 mm  
Lateral blades 58 mm  
Center blade 57 x 60 mm



NF.10.64.25  
Center blade 25 x 75 mm

**JUDD-MASON**  
NF.10.64.30  
max. spread 100 mm  
Lateral blades 70 mm  
Center blade 25 x 75 mm

NF.10.66.02  
Center blade 24 x 24 mm



NF.10.74.10  
center blade 24 x 24 mm

**BALFOUR-BABY**  
NF.10.66.01  
max. spread 90 mm  
Lateral blades 27 mm  
Center blade 24 x 24 mm



# Self-retaining Retractors



NF.10.73.30 30 x 60mm  
NF.10.73.45 30 x 45mm



NF.10.73.43 43 x 60mm  
NF.10.73.54 43 x 45mm



NF.10.73.58 58 x 60mm



NF.10.76.41  
80 x 80 mm



NF.10.77.33  
90 mm  
Lateral blades only (Pair)

max. spread 180 mm



NF.10.77.10  
75 mm  
Lateral blades only (Pair)

NF.10.77.30  
Frame only

NF.10.75.20  
63 x 38 mm  
Center blade only

BALFOUR-MEDICON  
NF.10.77.00

# Self-retaining Retractors



BALFOUR-MEDICON  
NF.10.77.40

NF.10.77.42  
60 mm  
Lateral blades only (Pair)

NF.10.77.41  
Frame only

NF.10.75.30  
75 x 50 mm  
Center blade only



NF.10.77.43  
110 mm  
Lateral blades only (Pair)



NF.10.80.75  
70 x 100 mm  
Center blade only

# Self-retaining Retractors



ULRICH-ST. GALLEN  
NF.10.65.05



ULRICH-ST. GALLEN  
NF.10.65.10  
NF.10.65.11

NF.10.75.30  
Center blade 75 x 50 mm

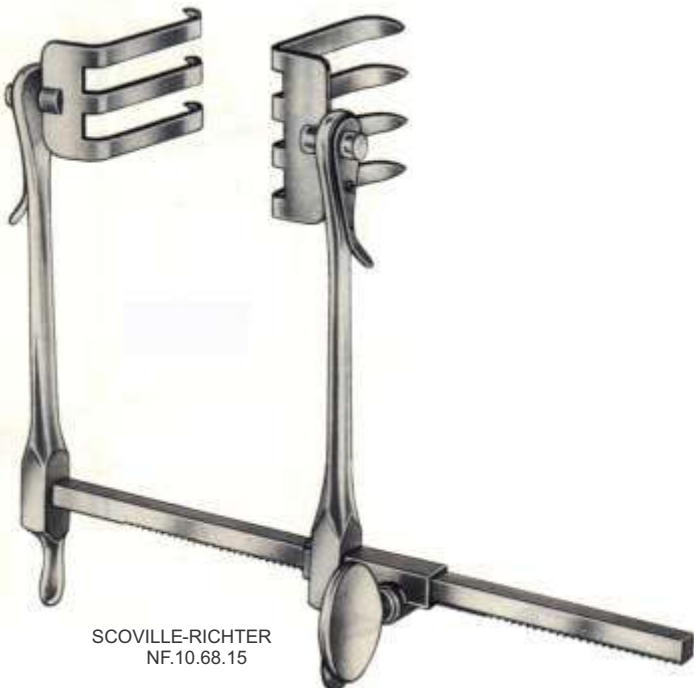

SCOVILLE-RICHTER  
NF.10.68.15



BALFOUR  
NF.10.69.10  
max. spread 180 mm

Lateral blades 65 mm  
Center blade 75 x 50 mm

# Self-retaining Retractors

NF.10.76.40  
Center blade 85 x 65 mm



BALFOUR  
NF.10.70.15  
max. spread 180 mm  
Lateral blades 100 mm  
Center blade 85 x 65 mm

BALFOUR  
NF.10.70.17  
max. spread 250 mm  
Lateral blades 100 mm  
Center blade 85 x 65 mm

NF.10.75.30  
Center blade 75 x 50 mm



BALFOUR  
NF.10.71.11  
max. spread 180 mm  
Lateral blades 30 x 60 mm  
Center blade 75 x 50 mm



ULRICH-ST. GALLEN  
NF.10.72.16



NF.10.73.32  
32 x 90 mm



NF.10.73.35  
30 x 60 mm

# Self-retaining Retractors

NF.10.79.25  
30 x 40 mm  
blade only

NF.10.79.26  
40 x 40 mm  
blade only

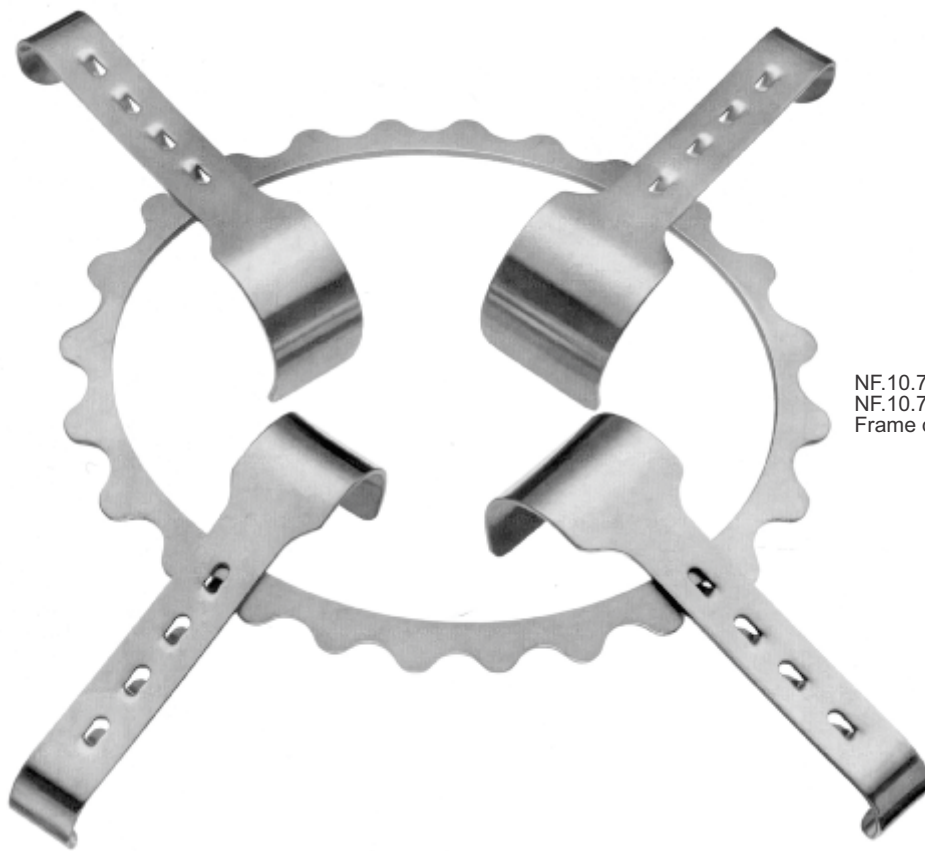

NF.10.79.11 180 x 150 mm  
NF.10.79.12 225 x 180 mm  
Frame only

DENIS BROWNE  
NF.10.79.01  
2 x NF.10.79.25  
2 x NF.10.79.26  
1 x NF.10.79.11

NF.10.79.02  
2 x NF.10.79.25  
2 x NF.10.79.26  
1 x NF.10.79.12

# Self-retaining Retractors

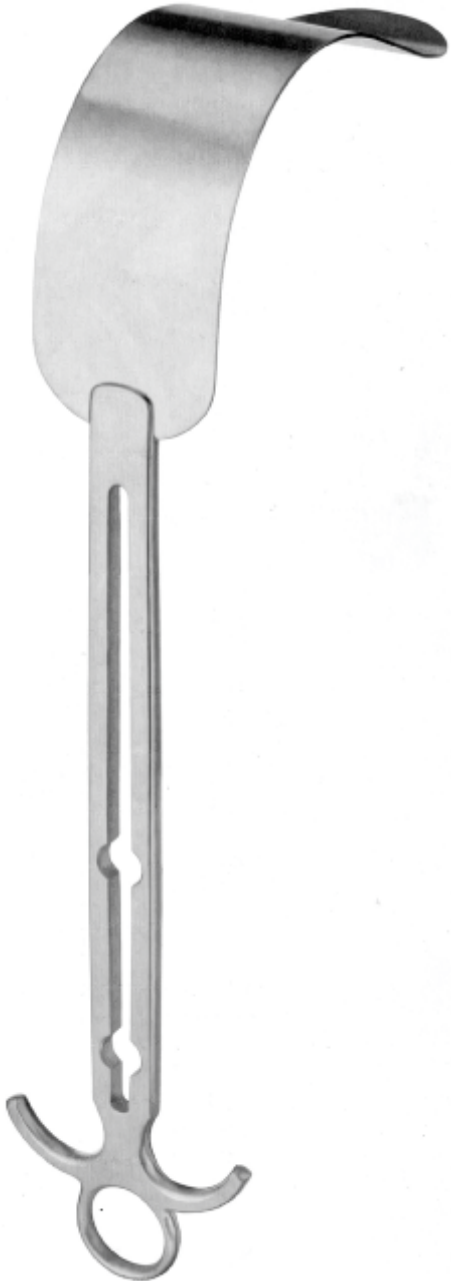

NF.10.81.85  
50 x 125 mm

NF.10.78.50  
Center blade 70 x 100 mm

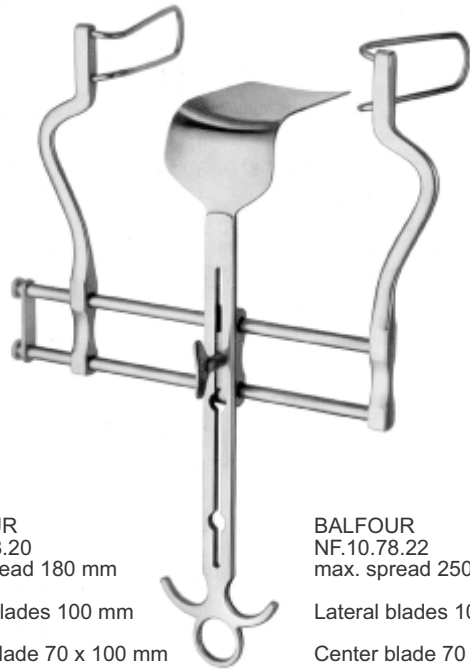

BALFOUR  
NF.10.78.20  
max. spread 180 mm  
Lateral blades 100 mm  
Center blade 70 x 100 mm

BALFOUR  
NF.10.78.22  
max. spread 250 mm  
Lateral blades 100 mm  
Center blade 70 x 100 mm

# Self-retaining Retractors

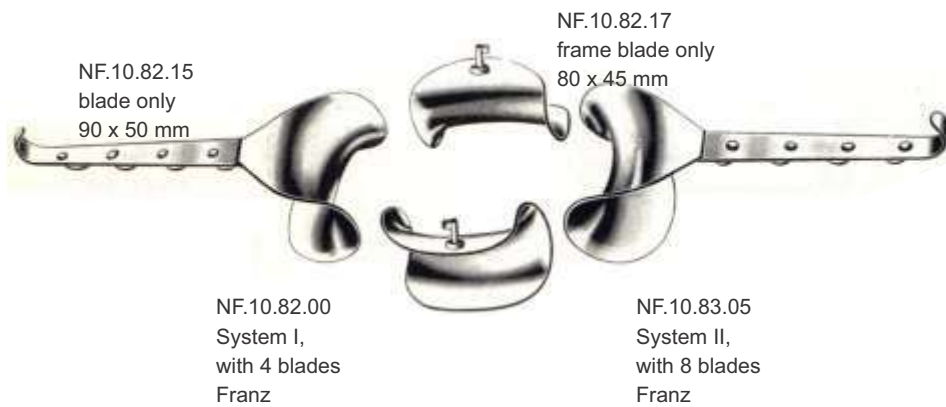
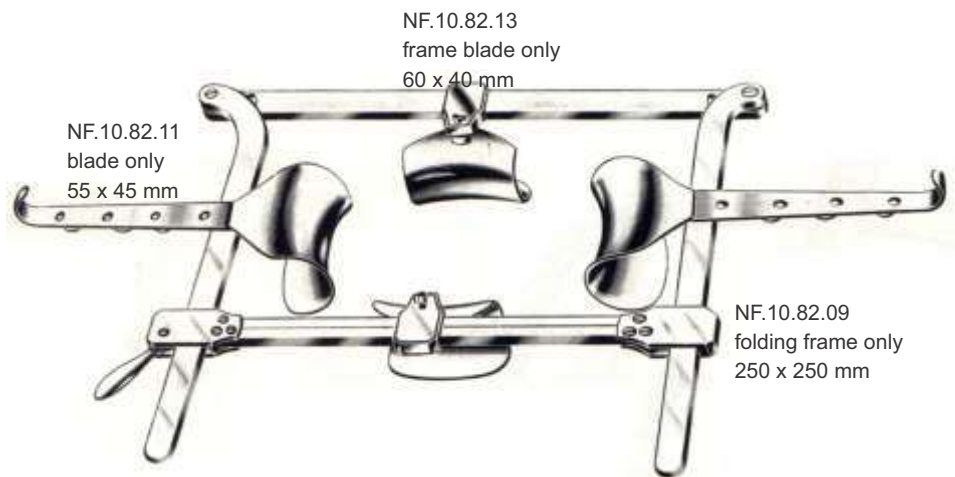

# Self-retaining Retractors



KIRSCHNER  
NF.10.84.05  
1 x NF.10.86.06  
2 x NF.10.85.14  
2 x NF.10.85.15

NF.10.84.06  
270 x 270 mm  
Frame only



NF.10.85.16 80 x 65 mm  
NF.10.85.18 65 x 80 mm



NF.10.85.19  
90 x 85 mm



# Self-retaining Retractors

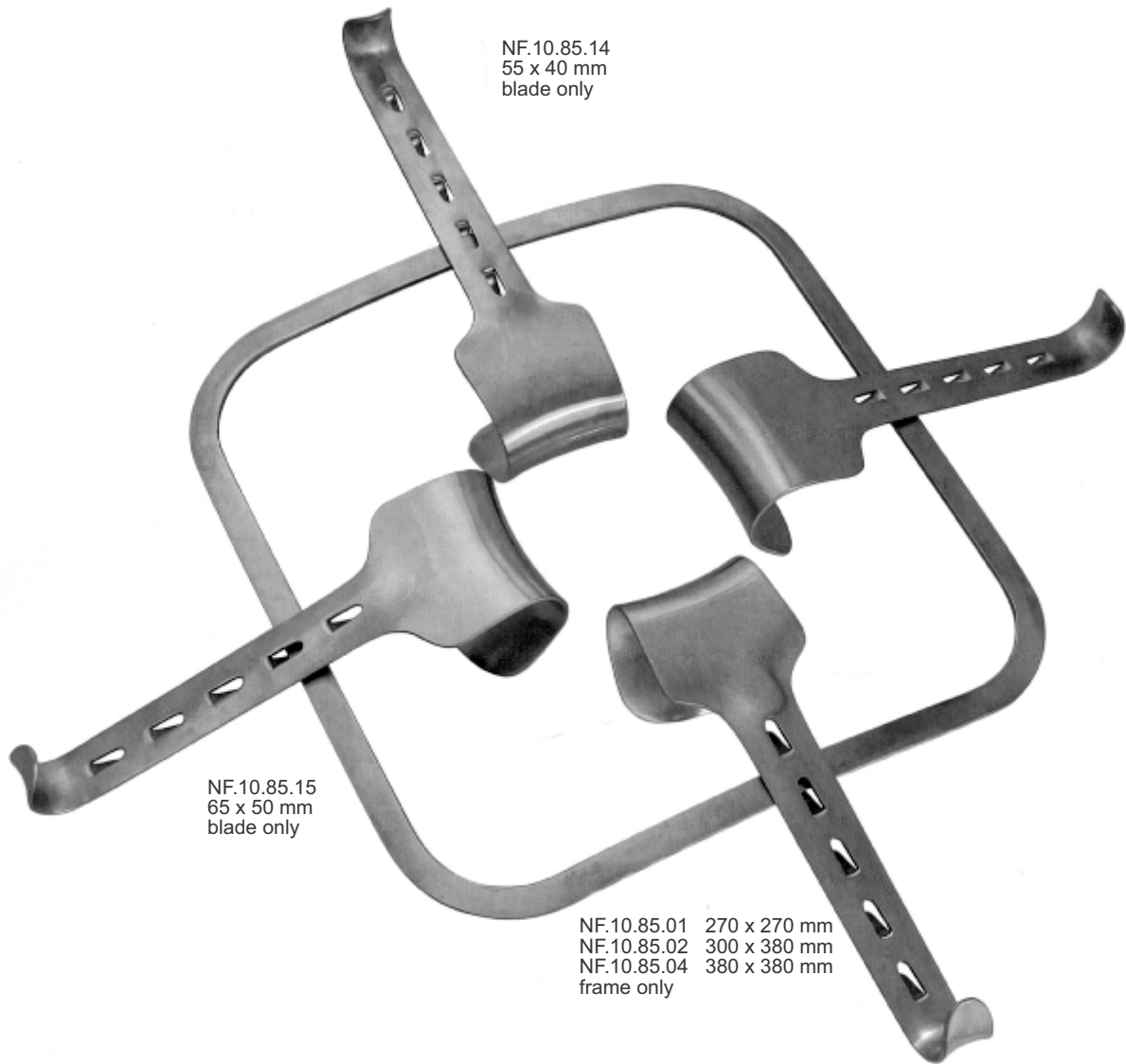

NF.10.85.14  
55 x 40 mm  
blade only

NF.10.85.15  
65 x 50 mm  
blade only

NF.10.85.01 270 x 270 mm  
NF.10.85.02 300 x 380 mm  
NF.10.85.04 380 x 380 mm  
frame only

NF.10.85.00  
2 x NF.10.85.14  
2 x NF.10.85.15  
1 x NF.10.85.01

NF.10.85.03  
2 x NF.10.85.14  
2 x NF.10.85.15  
1 x NF.10.85.04

KIRSCHNER

# Self-retaining Retractors

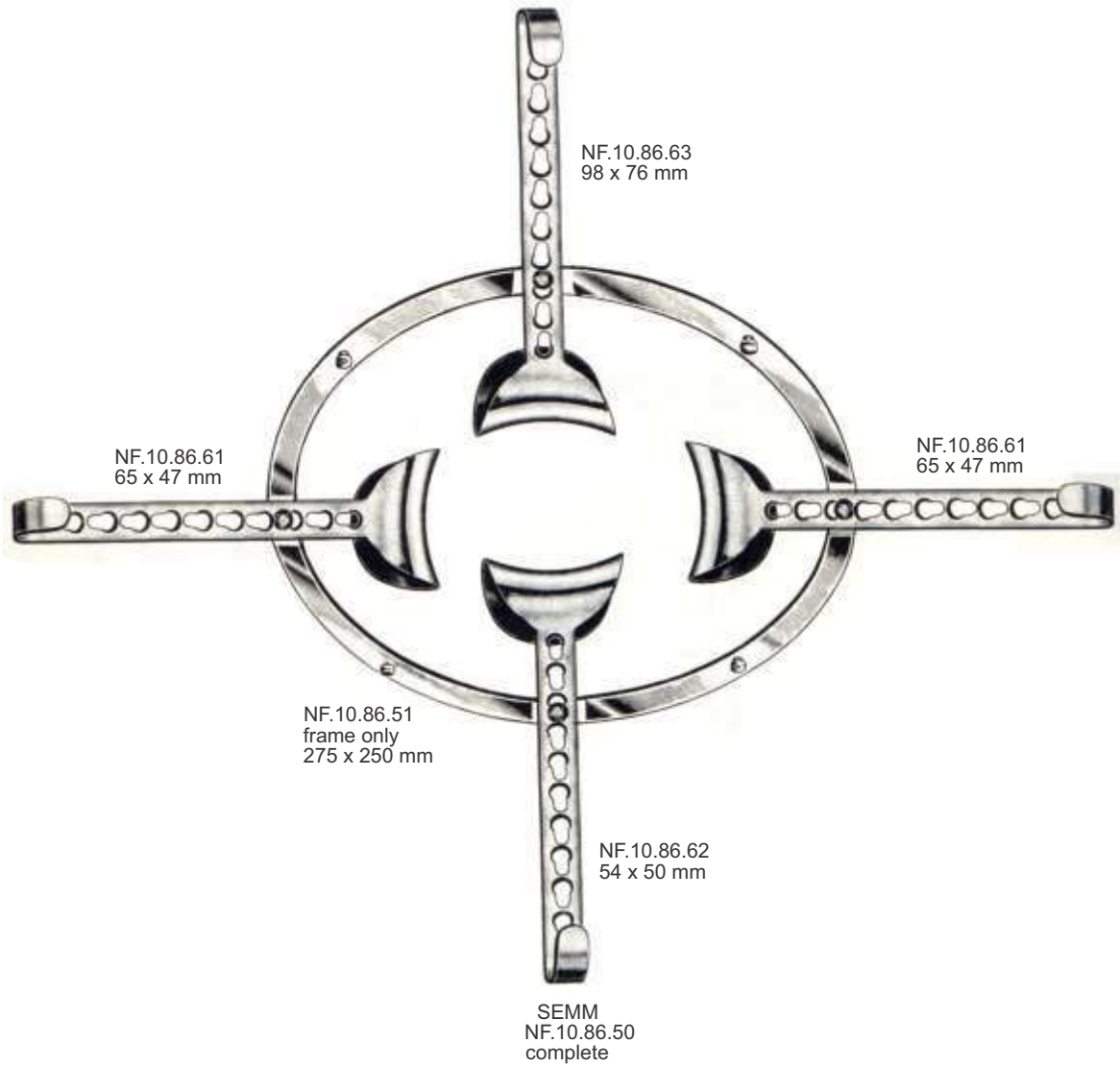

# Self-retaining Retractors



NF.10.86.44  
50 x 98 mm  
blade only



NF.10.86.45  
35 x 105 mm  
blade only



NF.10.86.43  
94 x 83 mm  
blade only



NF.10.86.41  
57 x 45 mm  
blade only

NF.10.86.41  
57 x 45 mm  
blade only

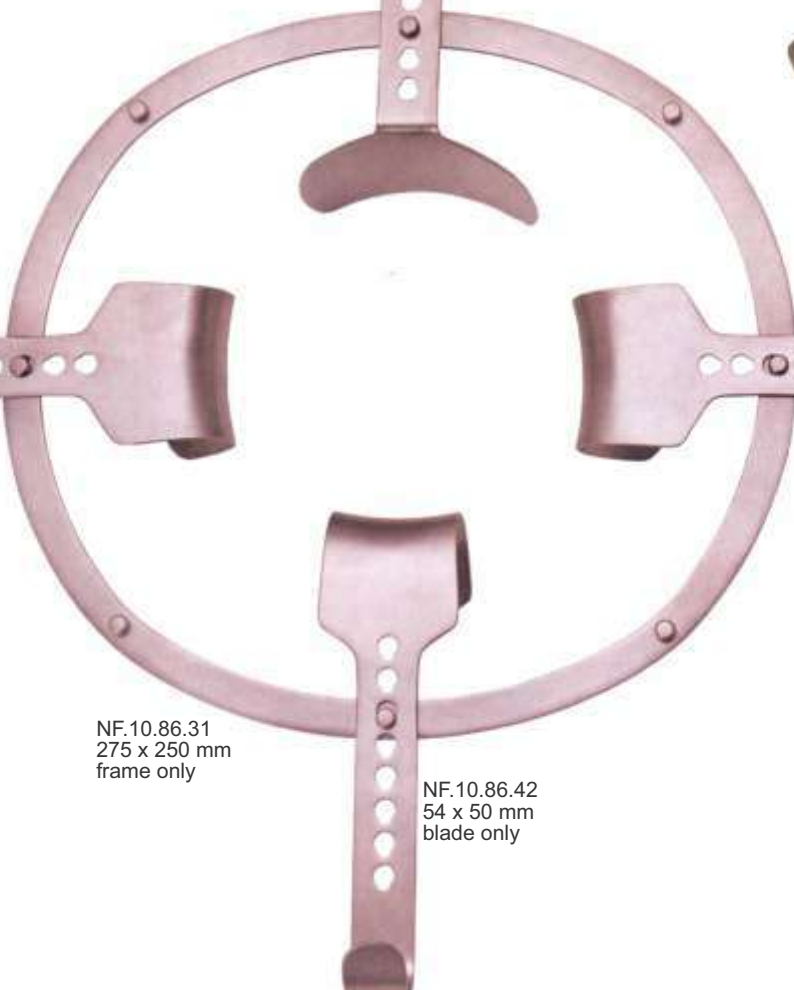

NF.10.86.31  
275 x 250 mm  
frame only



NF.10.86.42  
54 x 50 mm  
blade only

SEMM  
NF.10.86.00  
1 x NF.10.86.42 - NF.10.86.45  
2 x NF.10.86.41  
1 x NF.10.86.31

# Self-retaining Retractors



**DOYEN**  
NF.10.87.01 95 x 60 mm  
NF.10.87.02 105 x 65 mm  
NF.10.87.03 115 x 65 mm  
NF.10.87.04 125 x 65 mm  
29 cm/ 11½"



**ROCHARD**  
NF.10.88.01 95 x 60 mm  
NF.10.88.02 105 x 65 mm  
NF.10.88.03 115 x 65 mm  
NF.10.88.04 135 x 65 mm  
NF.10.88.05 155 x 65 mm  
29 cm/ 11½"

# Self-retaining Retractors

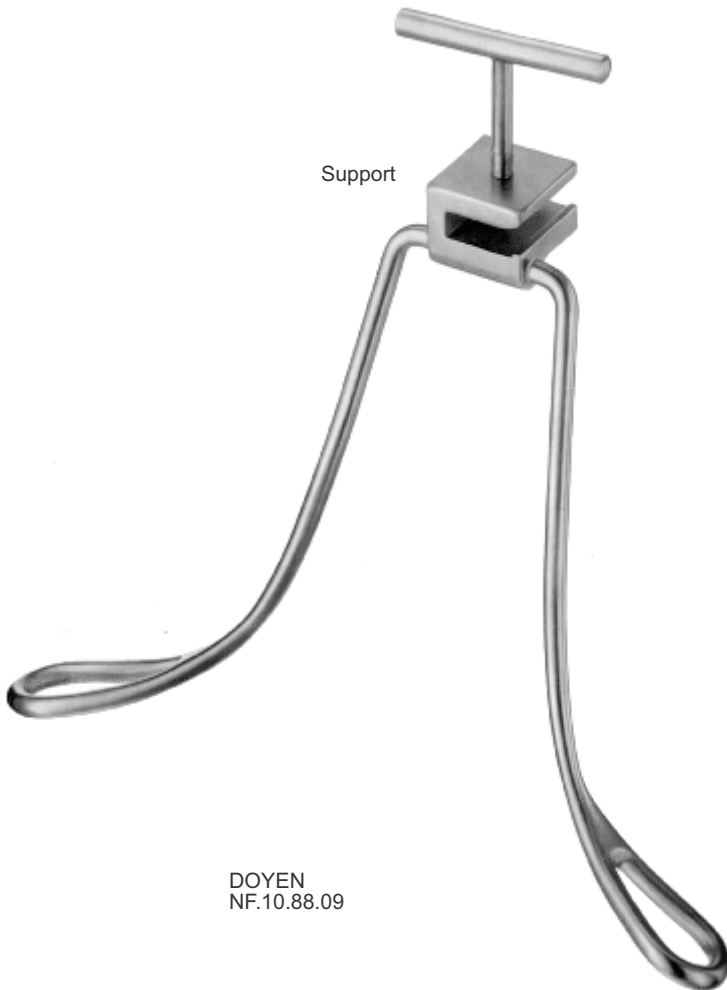

DOYEN  
NF.10.88.09

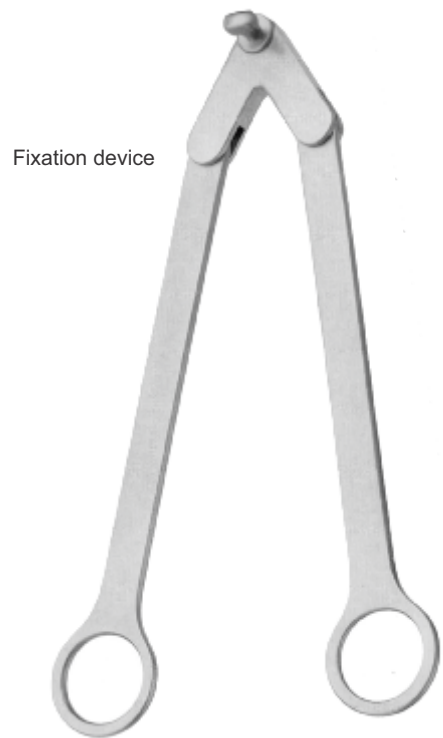

ROCHARD  
NF.10.88.19  
19 cm / 7½"

# Self-retaining Retractors

with 2 rotatable blades 25 x 60 mm



NF.10.90.09  
Frame only

O'SULLIVAN-O'CONNOR  
NF.10.90.00

- 2 x NF.10.90.11
- 1 x NF.10.90.12
- 1 x NF.10.90.09



NF.10.90.11  
45 x 85 mm  
Blade only



NF.10.90.12  
70 x 105 mm  
Blade only

# Self-retaining Retractors

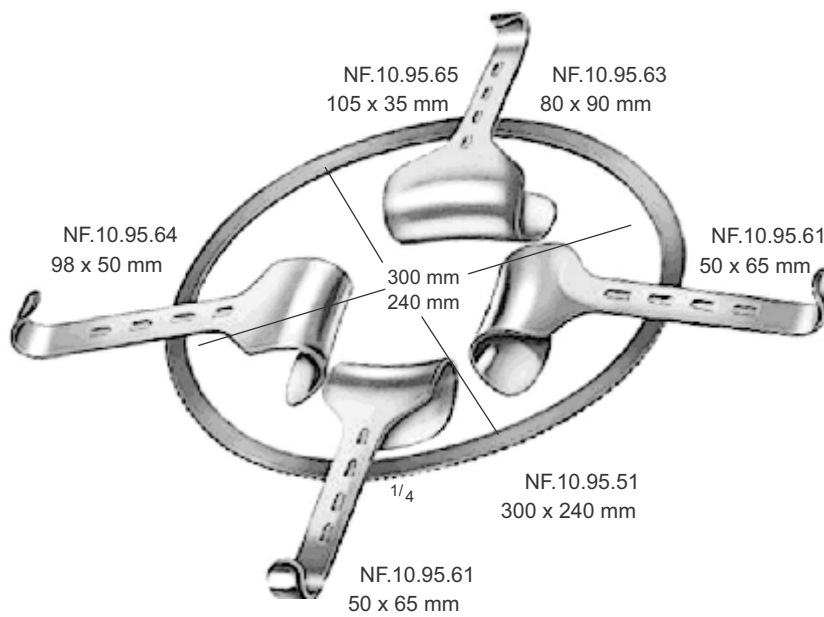

KIRSCHNER  
NF.10.95.00

Complete consisting of

- |             |   |                                |
|-------------|---|--------------------------------|
| NF.10.95.51 | 1 | Frame, 300 x 240 mm            |
| NF.10.95.61 | 3 | Hook-on retractors, 50 x 65 mm |
| NF.10.95.63 | 1 | Retractor, 80 x 90 mm          |
| NF.10.95.64 | 1 | Retractor, 98 x 50 mm          |
| NF.10.95.65 | 1 | Retractor, 105 x 35 mm         |

# Cardiovascular Instruments

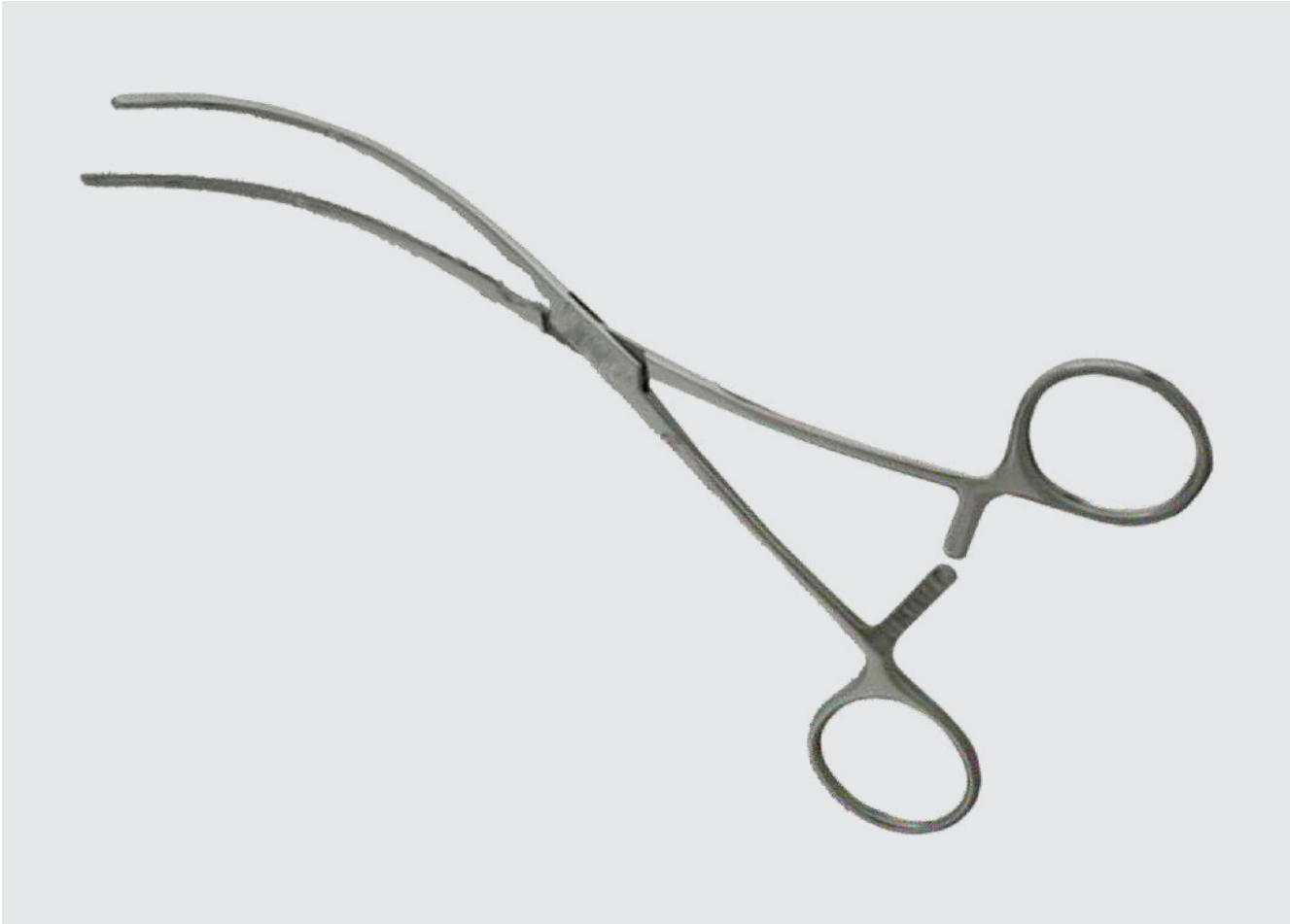



## Bulldog clamps



DEBAKEY "AT"

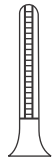

NF.10.01.75  
7.5 cm / 3"

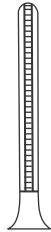

NF.10.01.85  
8.5 cm / 3 3/8"

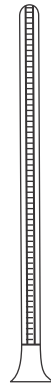

NF.10.01.90  
10.5 cm / 4 1/8"

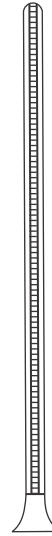

NF.10.01.92  
12 cm / 4 3/4"



DEBAKEY "AT"



NF.10.02.70  
7 cm / 2 3/4"



NF.10.02.80  
8 cm / 3 1/8"



NF.10.02.90  
10.5 cm / 4 1/8"







NF.10.02.95  
12 cm / 4 3/4"

# Cardiovascular Instruments







GLOVER "AT"

- |  |  |  |  |
|--|--|--|--|
|  |  |  |  |
| NF.10.03.60<br>6 cm / 2¼"  | NF.10.03.70<br>7.5 cm / 3"   | NF.10.03.90<br>9 cm / 3½"  | NF.10.03.99<br>11 cm / 4½"   |



GLOVER "AT"

- |   |   |  |   |
|---|---|--|---|
|  |  |  |  |
| NF.10.05.55<br>5.5 cm / 2¼"   | NF.10.05.65<br>6.5 cm / 2½"   | NF.10.05.85<br>8.5 cm / 3¼"  | NF.10.05.90<br>10.5 cm / 4¼"  |

# Cardiovascular Instruments



DE BAKEY

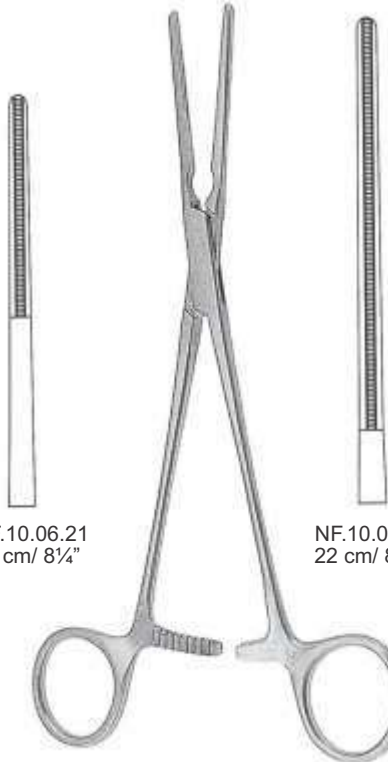

NF.10.06.21  
21 cm/ 8¼"

NF.10.06.22  
22 cm/ 8¾"

POTTS  
Coarctation Clamps

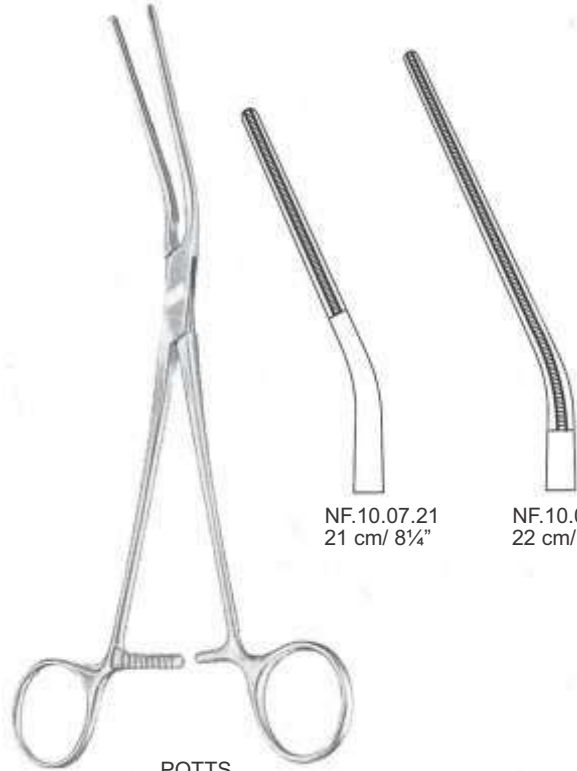

NF.10.07.21  
21 cm/ 8¼"

NF.10.07.22  
22 cm/ 8¾"

POTTS  
Coarctation Clamps



NF.10.08.21  
21 cm/ 8¼"

NF.10.08.22  
22 cm/ 8¾"

POTTS  
Coarctation Clamps

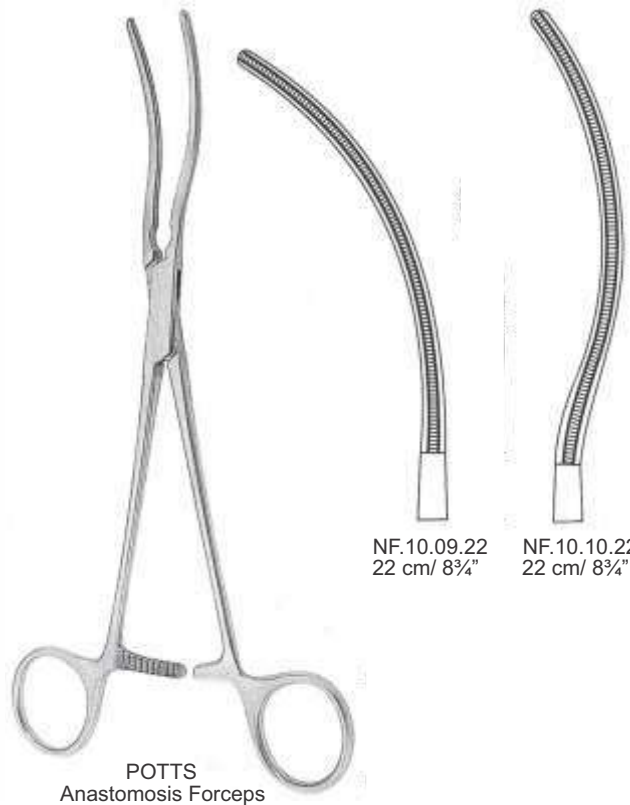

NF.10.09.22  
22 cm/ 8¾"

NF.10.10.22  
22 cm/ 8¾"

POTTS  
Anastomosis Forceps

# Cardiovascular Instruments



DE BAKEY



DE BAKEY  
Dissecting and Ligature Forceps



NF.10.11.19  
19 cm / 7½"



NF.10.12.23  
23 cm / 9"

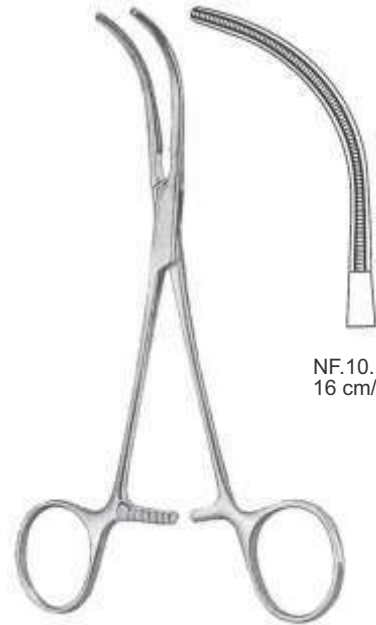

NF.10.13.16  
16 cm / 6¼"

DE BAKEY  
Peripheral Vascular Clamps



DE BAKEY  
Peripheral Vascular Clamps



NF.10.14.19  
19 cm / 7½"



NF.10.14.20  
20 cm / 8"

# Cardiovascular Instruments



DE BAKEY



LELAND-JONES  
Peripheral Vascular Clamps

NF.10.15.18  
18 cm / 7 1/8"

NF.10.15.19  
19 cm / 7 1/2"

NF.10.15.20  
20 cm / 8"



BAINBRIDGE  
Peripheral Vascular Clamps

NF.10.16.15  
15 cm / 6"

NF.10.16.18  
18 cm / 7 1/8"

NF.10.17.15  
15 cm / 6"

NF.10.17.18  
18 cm / 7 1/8"



DE BAKEY  
Renal Artery Clamps

NF.10.18.20  
20 cm / 8"

# Cardiovascular Instruments



DE BAKEY



DE BAKEY  
Aortic Aneurysm Clamps



NF.10.19.26  
26 cm / 10 1/4"

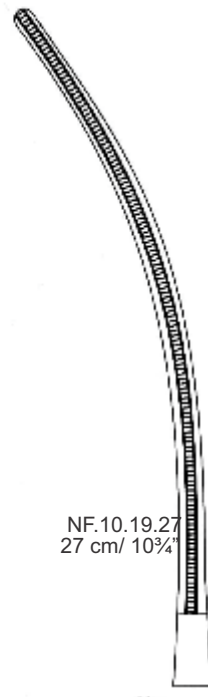

NF.10.19.27  
27 cm / 10 3/4"

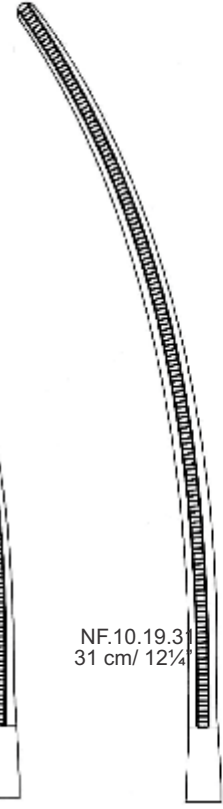

NF.10.19.31  
31 cm / 12 1/4"

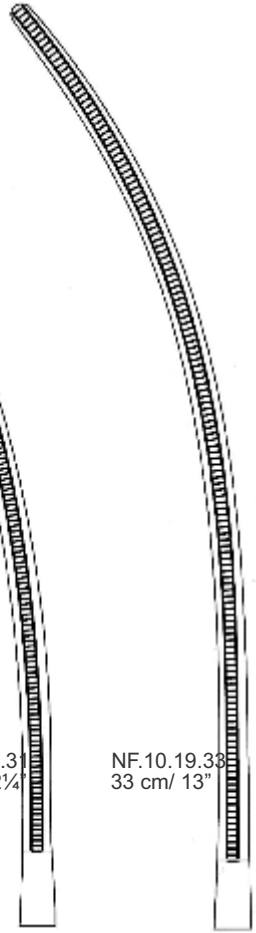

NF.10.19.33  
33 cm / 13"

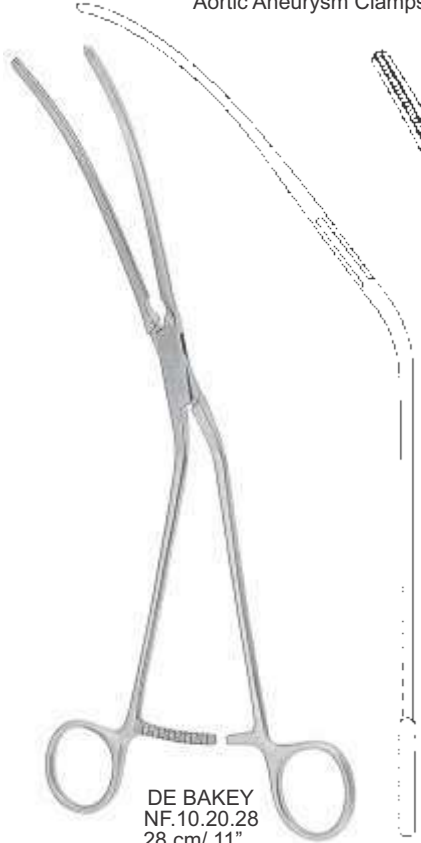

DE BAKEY  
NF.10.20.28  
28 cm / 11"



Aortic Aneurysm Clamps



DE BAKEY  
NF.10.20.30  
30 cm / 11 1/4"

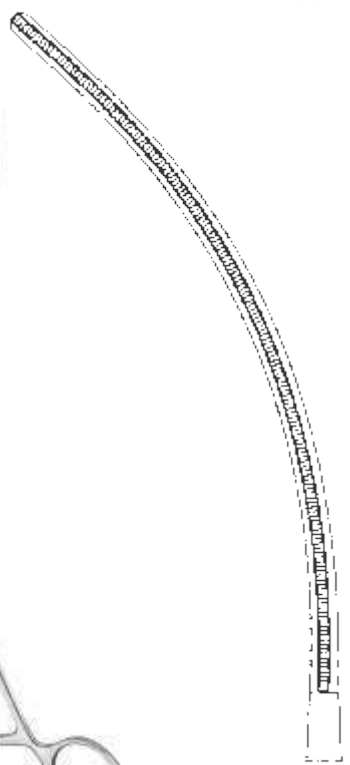

# Cardiovascular Instruments



DE BAKEY  
Aortic Clamps  
NF.10.21.27  
27 cm/ 10 $\frac{3}{4}$ "

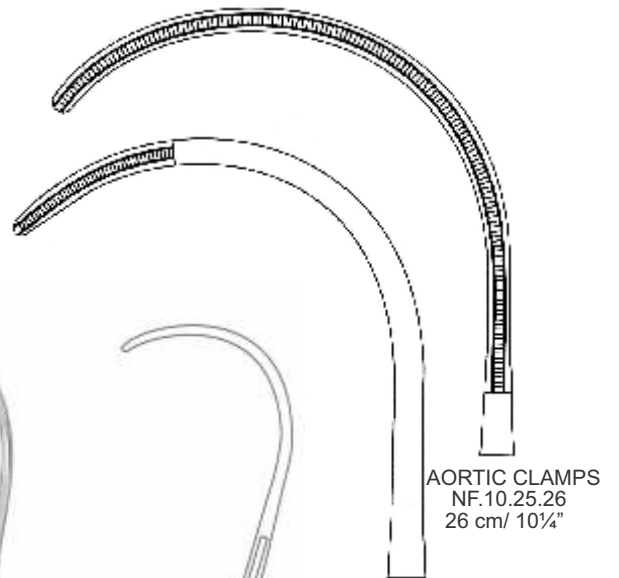
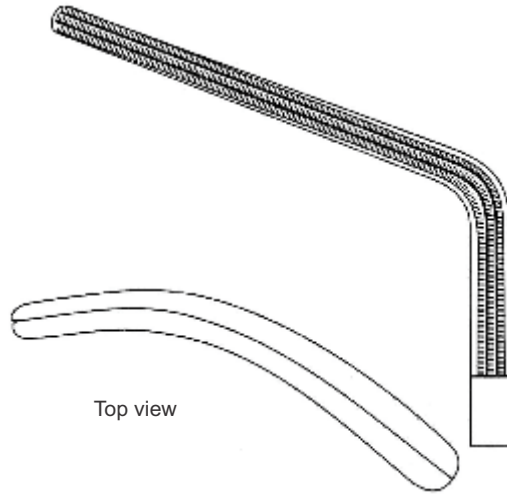

AORTIC CLAMPS  
NF.10.25.26  
26 cm/ 10 $\frac{1}{4}$ "



DE BAKEY  
Ligature Clamps

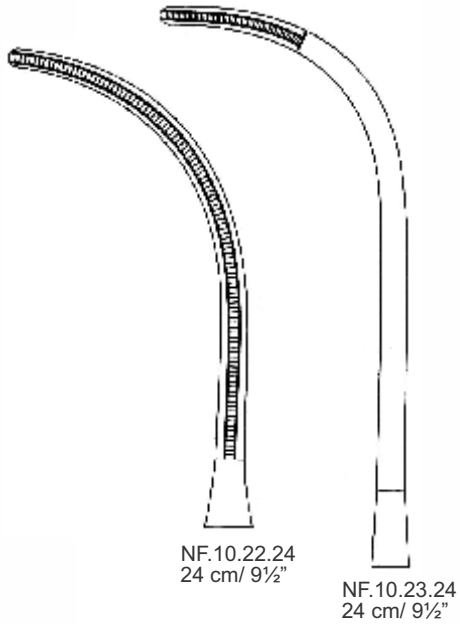

LIGATURE CLAMPS  
NF.10.24.25  
25 cm/ 10"



DE BAKEY

# Cardiovascular Instruments

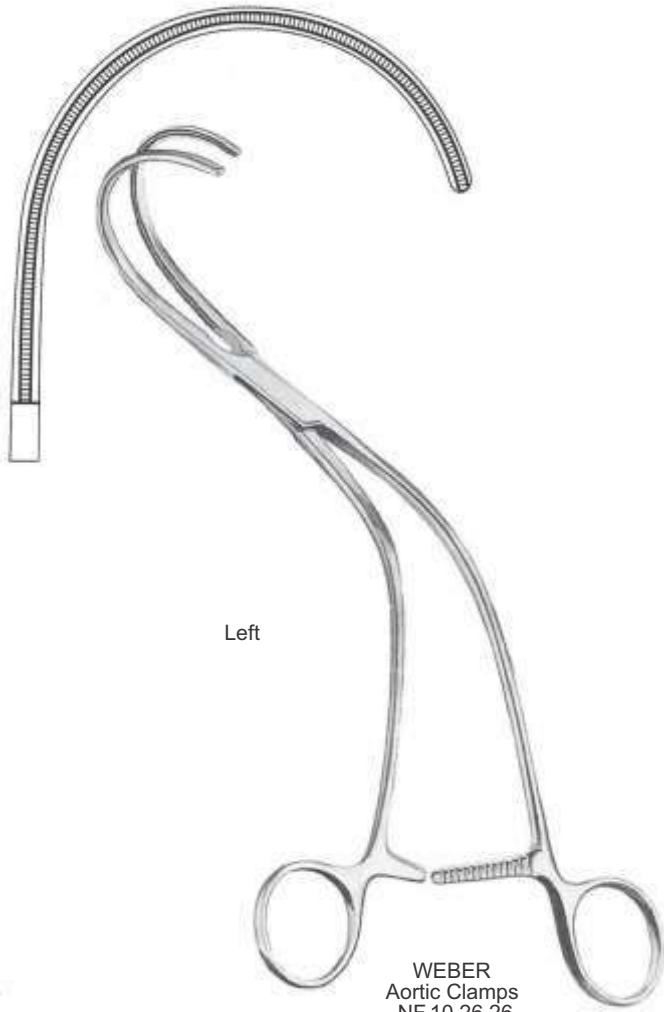

Left

WEBER  
Aortic Clamps  
NF.10.26.26  
26 cm/ 10¼"

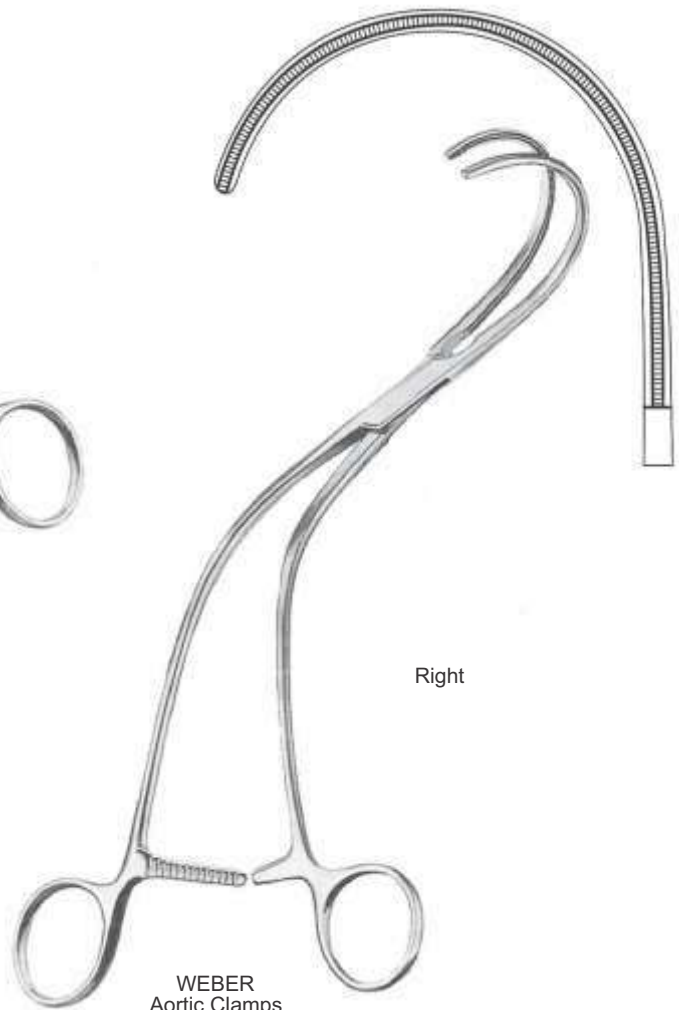

Right

WEBER  
Aortic Clamps  
NF.10.27.26  
26 cm/ 10¼"



# Cardiovascular Instruments

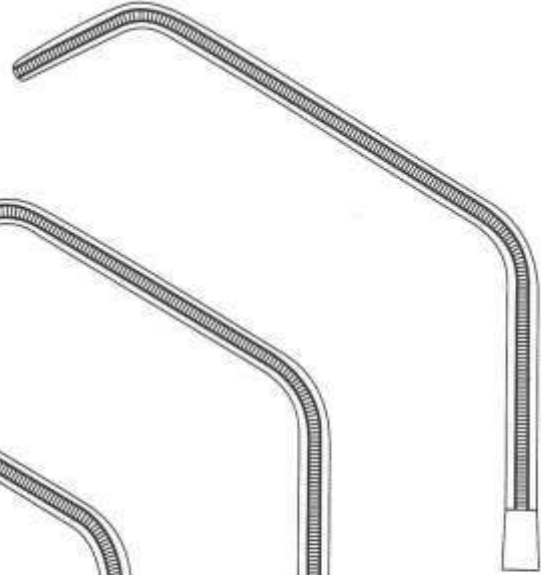

NF.10.28.27  
27.5 cm / 10 $\frac{1}{4}$ "

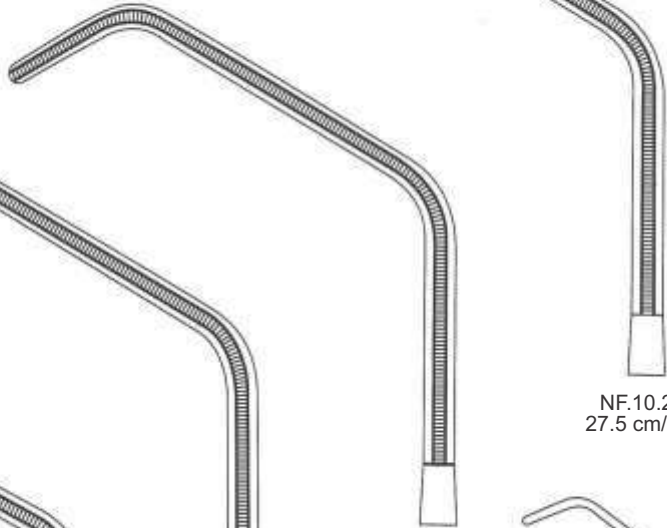

NF.10.28.26  
26.5 cm / 10 $\frac{1}{2}$ "

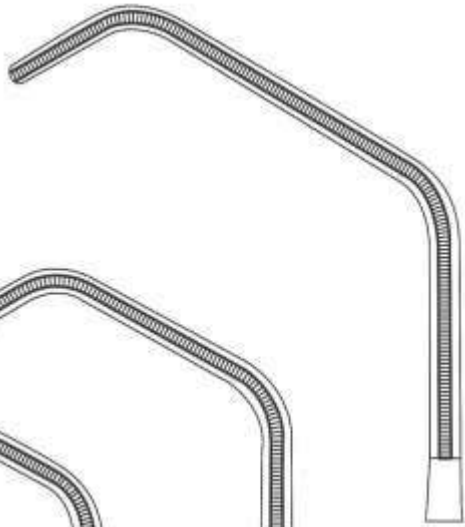

NF.10.28.25  
25 cm / 10"

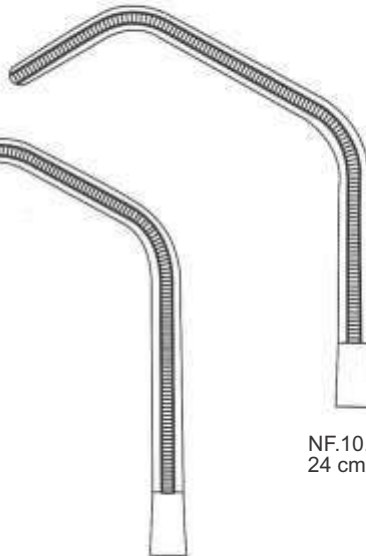

NF.10.24.24  
24 cm / 9 $\frac{1}{2}$ "

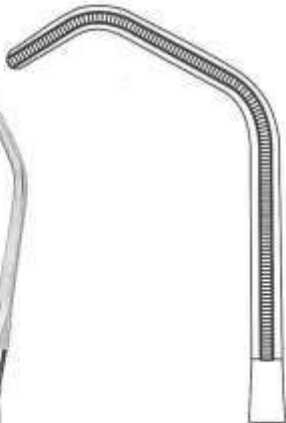

NF.10.24.25  
20.5 cm / 8 $\frac{1}{8}$ "



SATINSKY  
Tangential Occlusion  
Clamps



# Cardiovascular Instruments



DE BAKEY



HARKEN  
Auricle Clamps

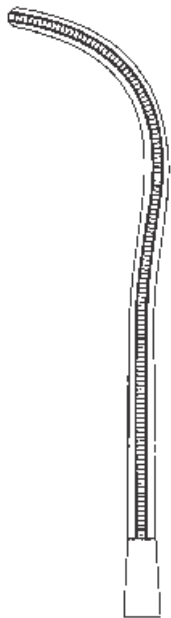

NF.10.29.24  
24 cm/ 9½"

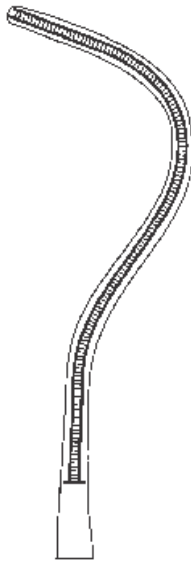

NF.10.30.24  
24 cm/ 9½"

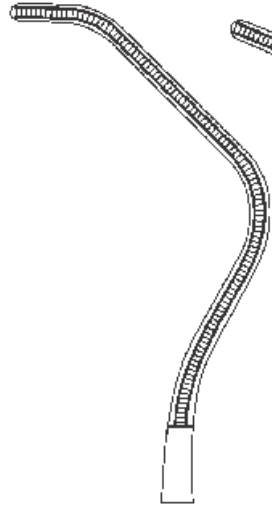

NF.10.31.24  
24 cm/ 9½"

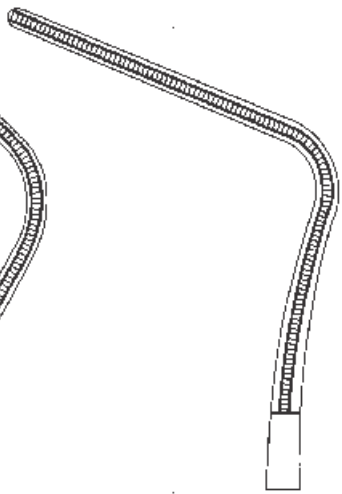

NF.10.32.24  
24 cm/ 9½"



LEES

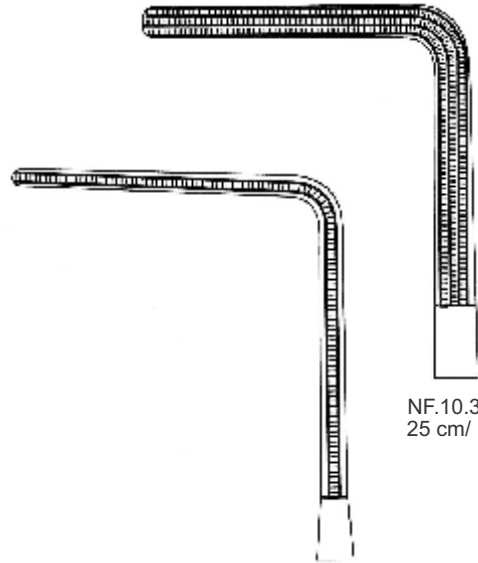

NF.10.33.23  
23 cm/ 9"

NF.10.33.25  
25 cm/ 10"

Bronchus Clamps

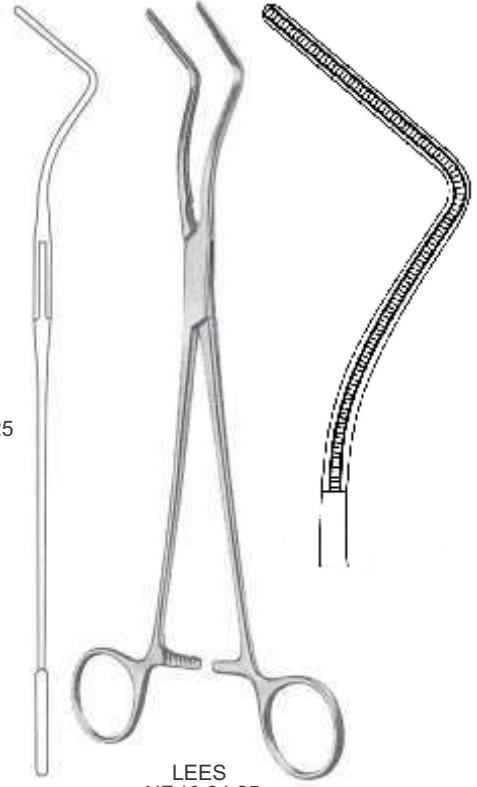

LEES  
NF.10.34.25  
25 cm/ 10"

# Cardiovascular Instruments

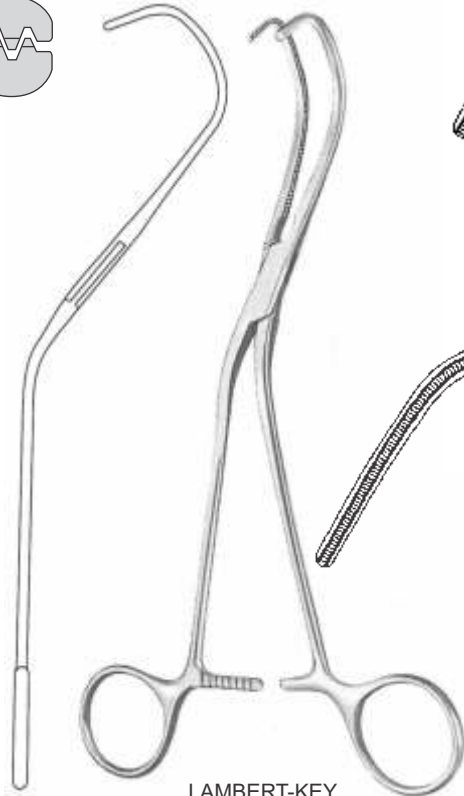

LAMBERT-KEY  
Aortic Clamps

NF.10.35.21  
21 cm/ 8¼"

NF.10.35.22  
21 cm/ 8¼"

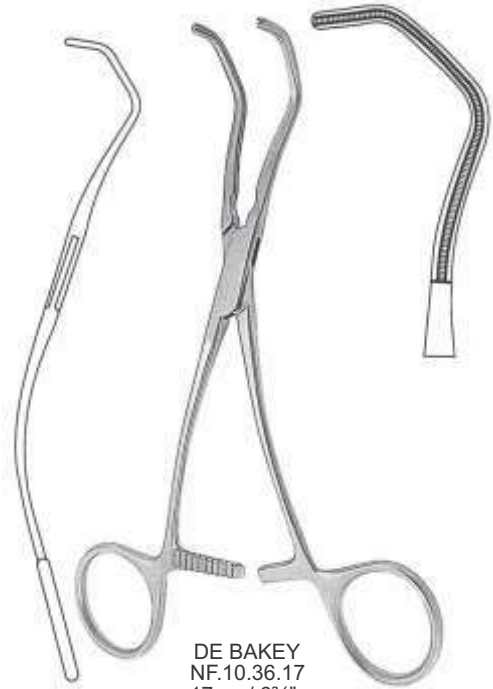

DE BAKEY  
NF.10.36.17  
17 cm/ 6¾"  
Anastomosis Clamps

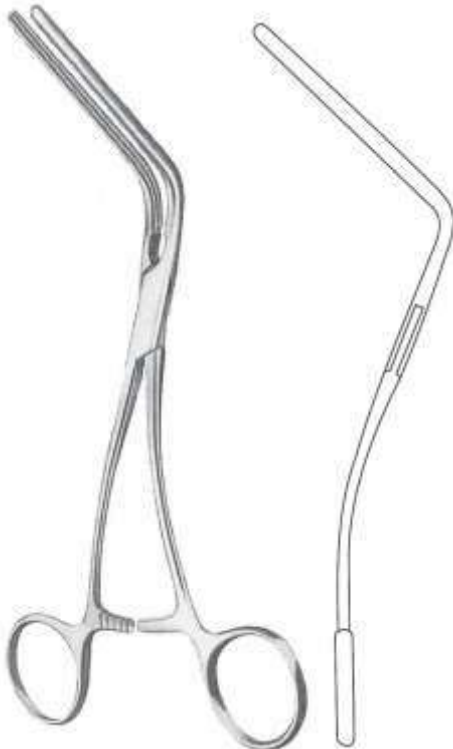

MORRIS-DE BAKEY  
Aortic Clamps

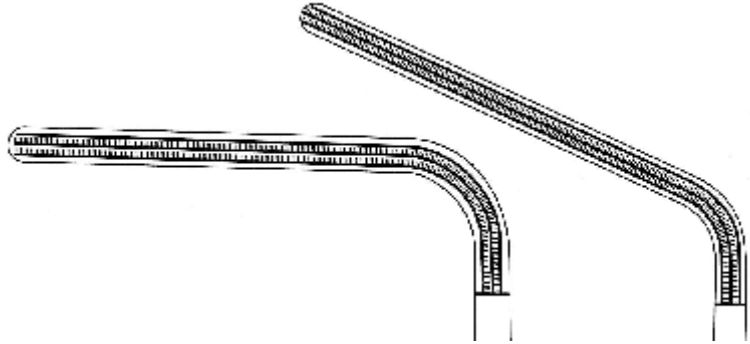

NF.10.37.18  
18 cm/ 7½"

NF.10.37.21  
20 cm/ 8"

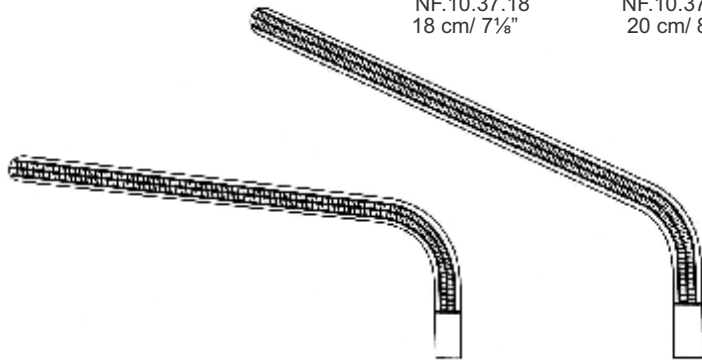

NF.10.37.23  
23 cm/ 9"

NF.10.37.26  
25 cm/ 10"

# Cardiovascular Instruments



DE BAKEY-BAHNSON  
Aneurysm Clamps  
for Iliac Artery

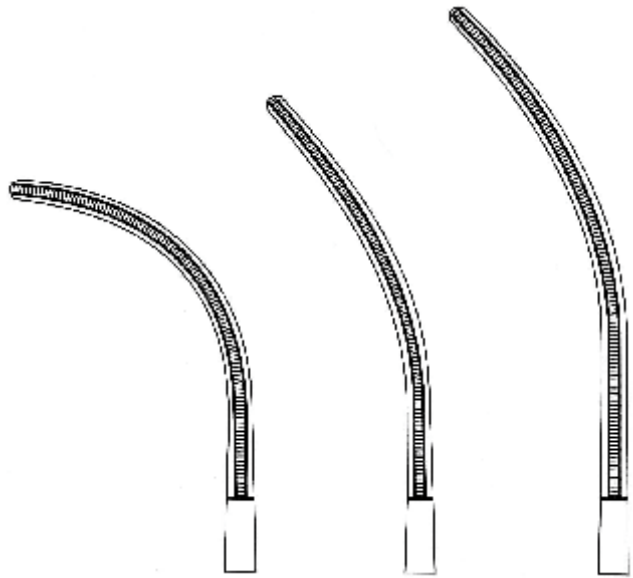

NF.10.38.23  
23 cm/ 9"

NF.10.38.24  
24 cm/ 9½"

NF.10.38.25  
25 cm/ 10"



DE BAKEY  
Coarctation Clamps

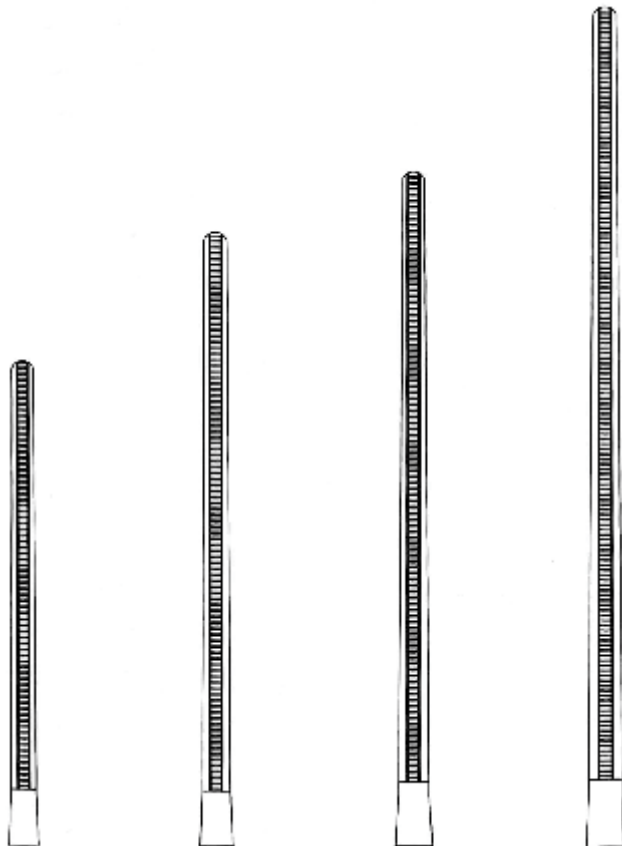

NF.10.39.21  
21.5 cm/ 8½"

NF.10.39.23  
23 cm/ 9"

NF.10.39.27  
27 cm/ 10¾"

NF.10.39.31  
27 cm/ 10¾"

# Cardiovascular Instruments



DE BAKEY  
Coarctation Clamps

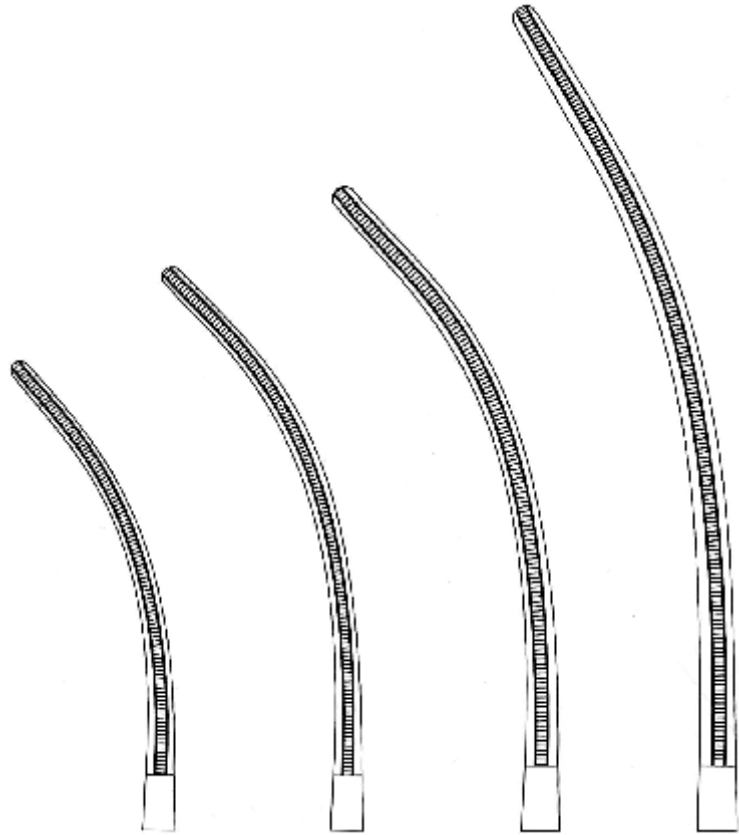

NF.10.40.21  
21.5 cm / 8½"

NF.10.40.23  
23 cm / 9"

NF.10.40.27  
27 cm / 10¾"

NF.10.40.31  
31 cm / 12¼"



DE BAKEY  
Multi-purpose Clamps

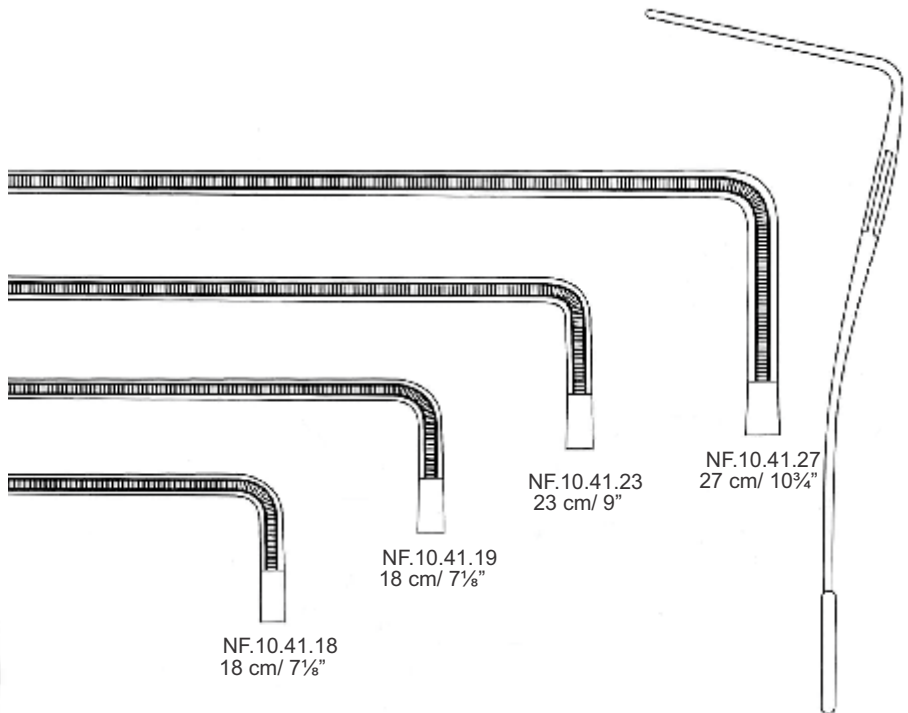

NF.10.41.18  
18 cm / 7½"

NF.10.41.19  
18 cm / 7½"

NF.10.41.23  
23 cm / 9"

NF.10.41.27  
27 cm / 10¾"

# Cardiovascular Instruments



**DE BAKEY**  
Multi-purpose Clamps

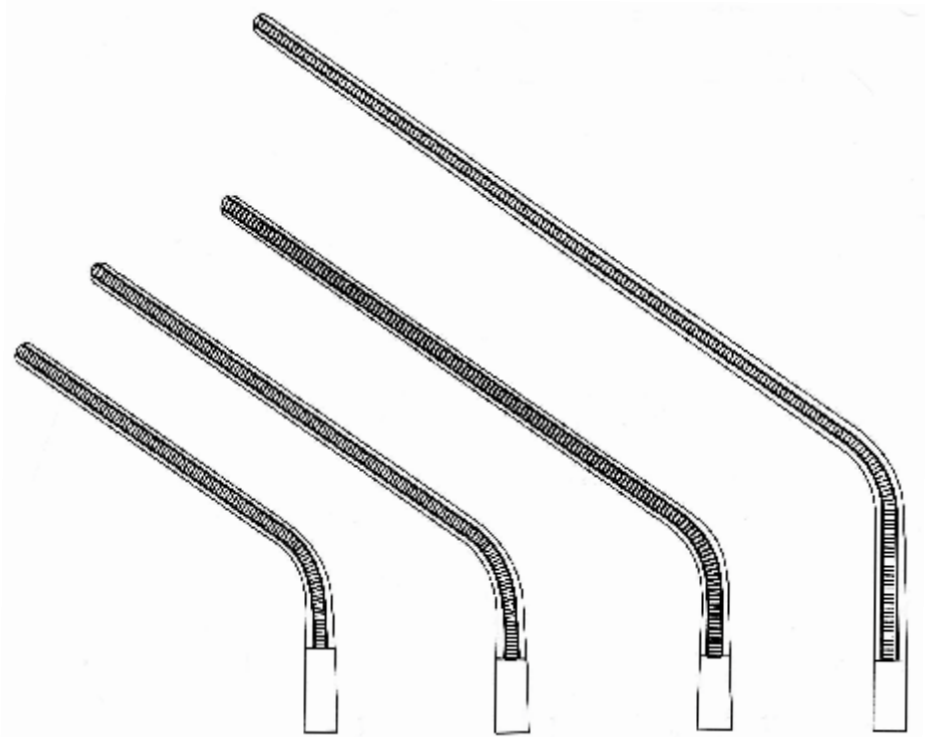

NF.10.42.20  
20 cm / 8"

NF.10.42.21  
21 cm / 8¼"

NF.10.42.25  
25 cm / 10"

NF.10.42.29  
29 cm / 11½"

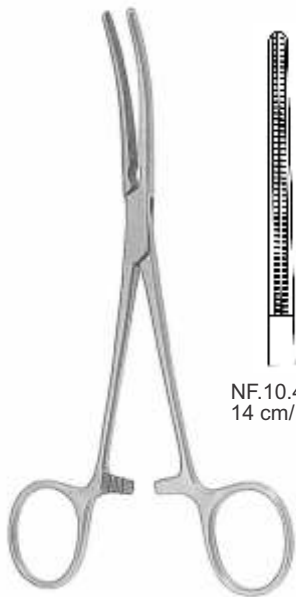

**DE BAKEY-PEAN**

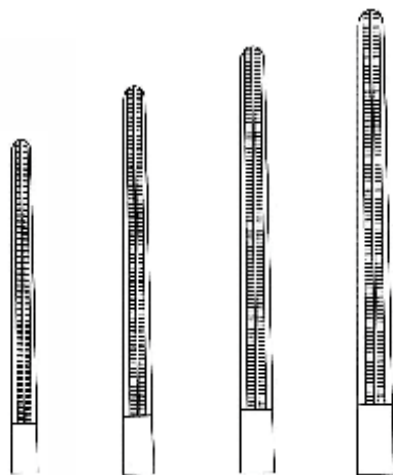

NF.10.43.14 NF.10.43.16 NF.10.43.18 NF.10.43.20  
14 cm / 5½" 16 cm / 6¼" 18 cm / 7⅛" 20 cm / 8"

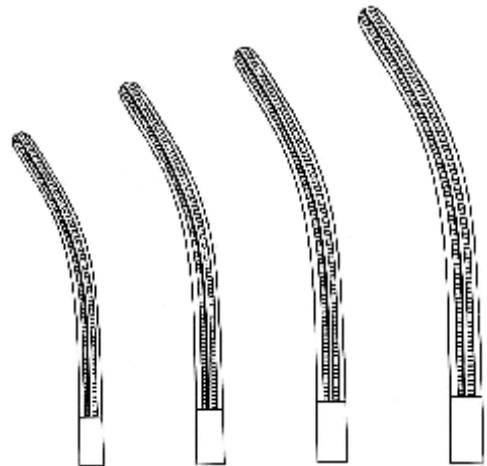

NF.10.44.14 NF.10.44.16 NF.10.44.18 NF.10.44.20  
14 cm / 5½" 16 cm / 6¼" 18 cm / 7⅛" 20 cm / 8"

# Cardiovascular Instruments



DE BAKEY  
NF.10.46.17  
17 cm/ 6¾"



DE BAKEY  
NF.10.47.16  
16 cm/ 6¼"

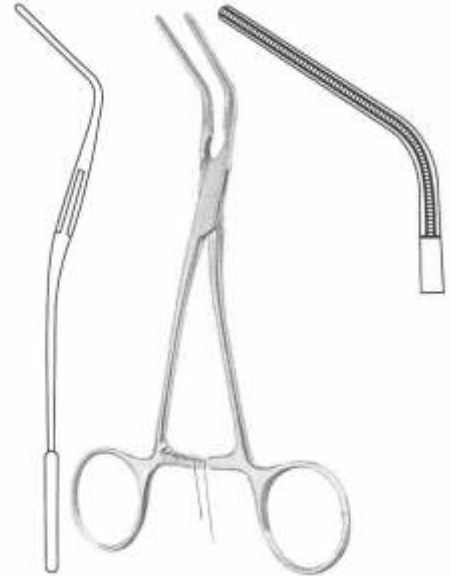

DE BAKEY  
NF.10.48.15  
15 cm/ 6"

## Multi-purpose Clamps

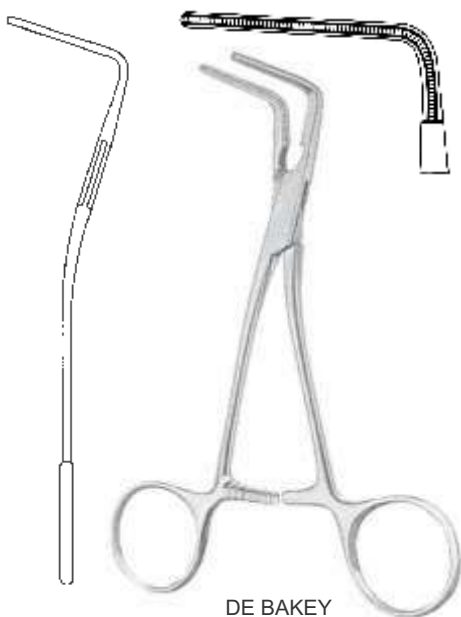

DE BAKEY  
NF.10.50.15  
15 cm/ 6"



DE BAKEY  
NF.10.51.17  
17 cm/ 6¾"

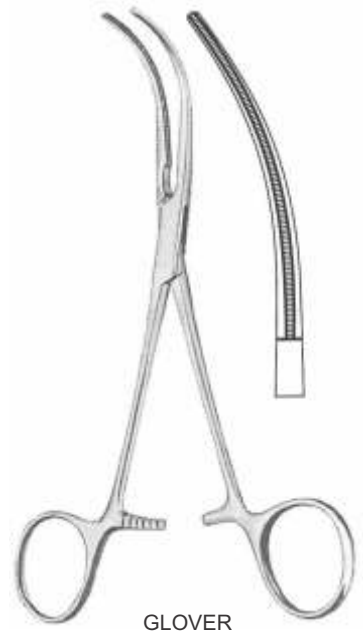

GLOVER  
NF.10.52.17  
17 cm/ 6¾"

# Cardiovascular Instruments

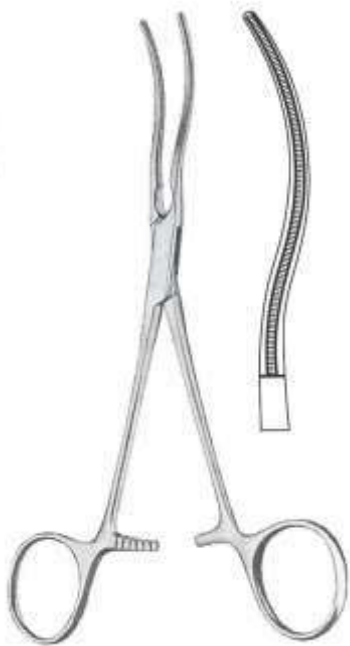

**COARCTATION CLAMPS**  
NF.10.53.17  
17 cm/ 6¾"



**LIGATURE CLAMPS**

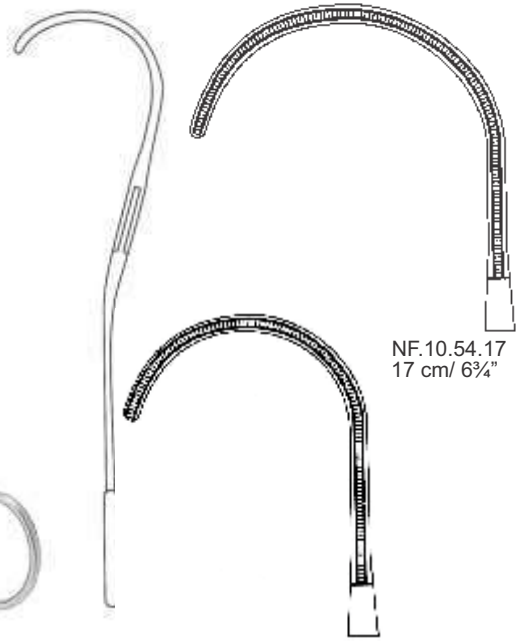

NF.10.54.16  
16 cm/ 6¼"

NF.10.54.17  
17 cm/ 6¾"

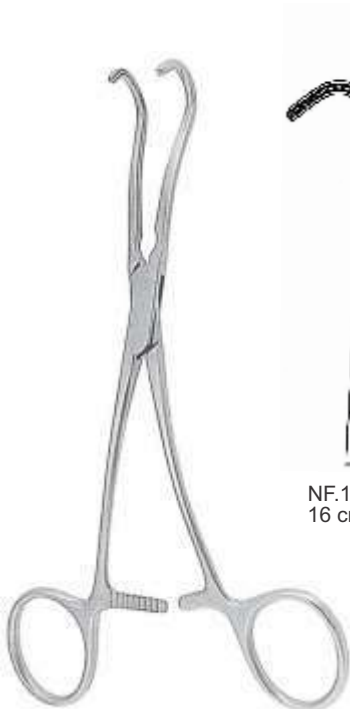

**DERRA**  
Anastomosis Clamps

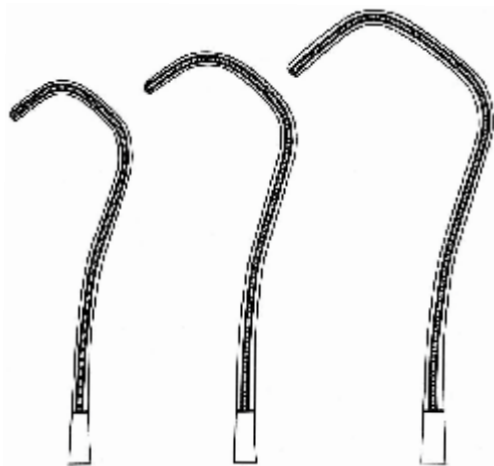

NF.10.55.16  
16 cm/ 6¼"

NF.10.55.17  
17 cm/ 6¾"

NF.10.55.18  
18 cm/ 7⅛"



**BECK**  
Tangential Occlusion Clamps  
NF.10.56.17  
17 cm/ 6¾"



# Cardiovascular Instruments

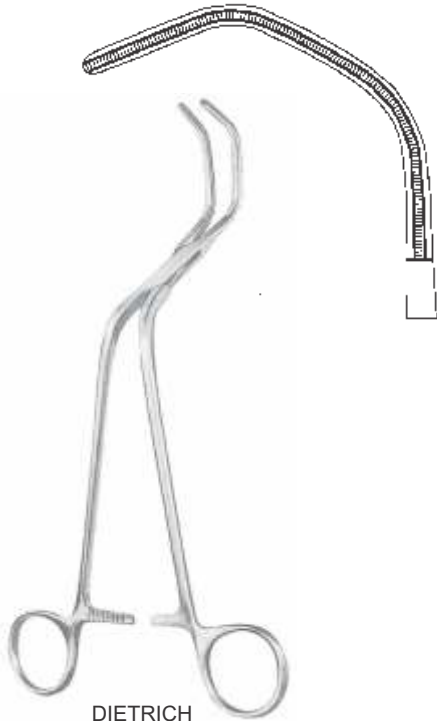

**DIETRICH**  
Aortic Clamps  
NF.10.56.21  
21 cm/ 8¼"



**OCHSNER**  
Aortic Clamps  
NF.10.56.24  
23.5 cm/ 9¼"

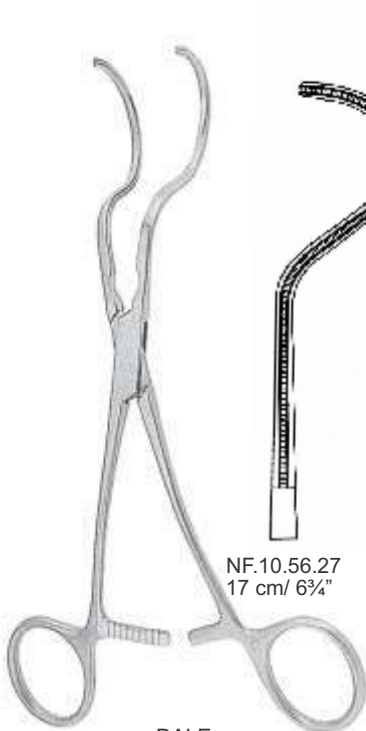

**DALE**  
Peripheral Vascular Clamps

NF.10.56.27  
17 cm/ 6¾"

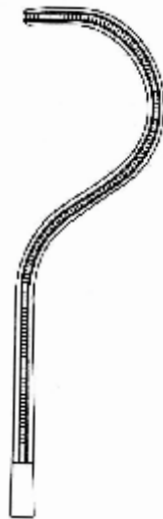

NF.10.56.58  
18 cm/ 7⅞"

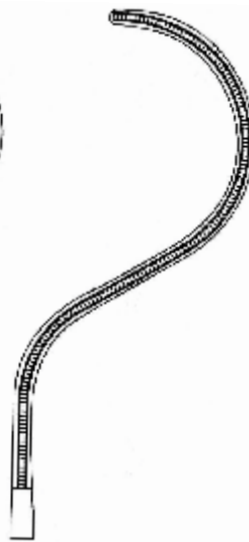

NF.10.56.59  
18.5 cm/ 7¼"

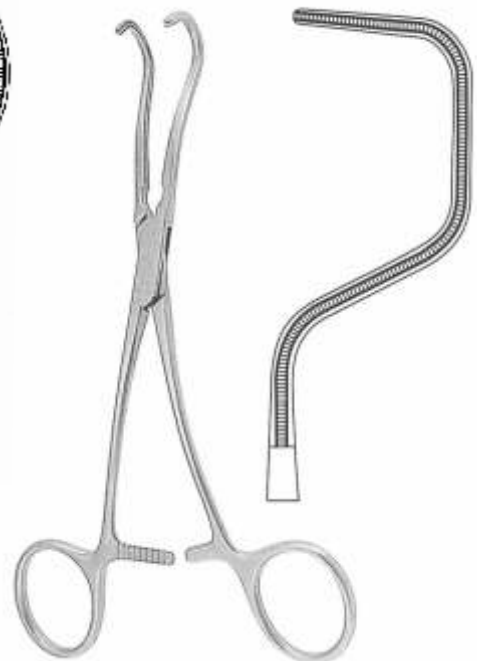

**DALE**  
NF.10.56.78  
18.5 cm/ 7¼"

# Cardiovascular Instruments



PEDIATRIC  
SURGERY



DE BAKEY  
NF.10.57.10  
10 cm/ 4"



DE BAKEY  
NF.10.57.11  
11 cm/ 4 1/4"



DE BAKEY  
NF.10.59.12  
12 cm/ 4 3/4"

## Bulldog clamps

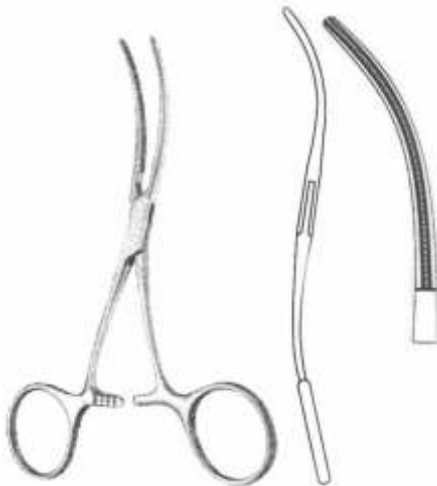

DE BAKEY  
NF.10.60.12  
12 cm/ 4 3/4"



DE BAKEY  
NF.10.61.13  
13 cm/ 5 1/8"

# Cardiovascular Instruments

3

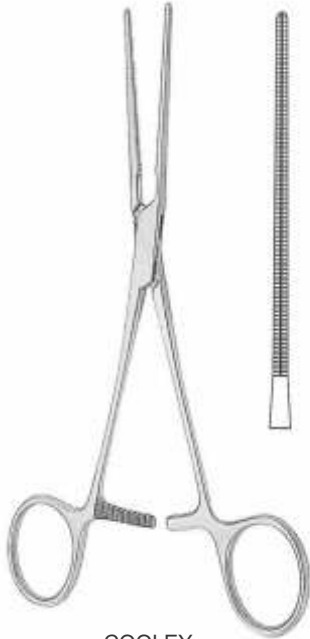

**COOLEY**  
Coarctation Forceps  
NF.11.65.17  
17 cm/ 6¾"

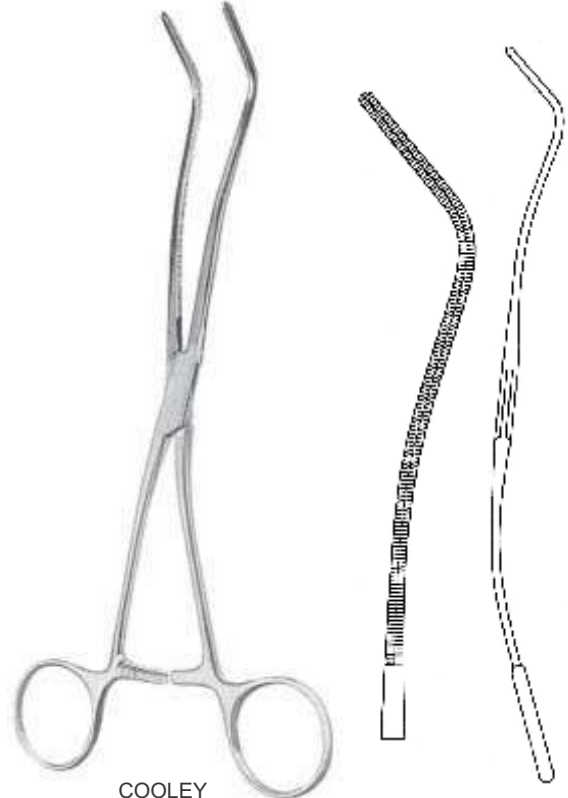

**COOLEY**  
Renal Artery Clamp also used  
for subclavian and carotid artery  
NF.11.66.20  
20 cm/ 8"

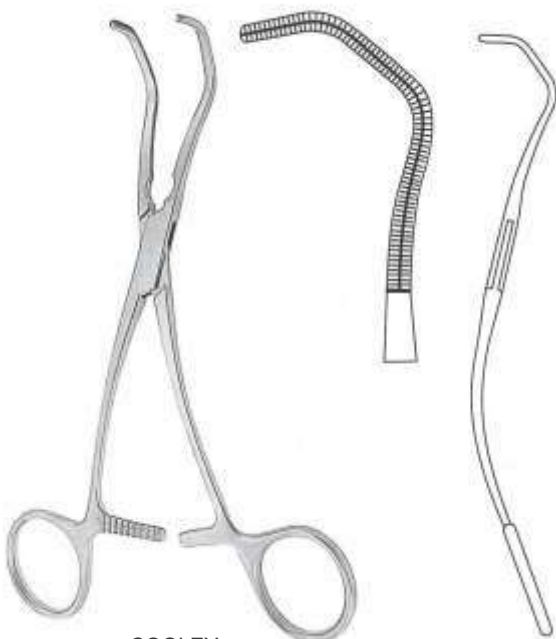

**COOLEY**  
NF.11.67.16  
16 cm/ 6¼"

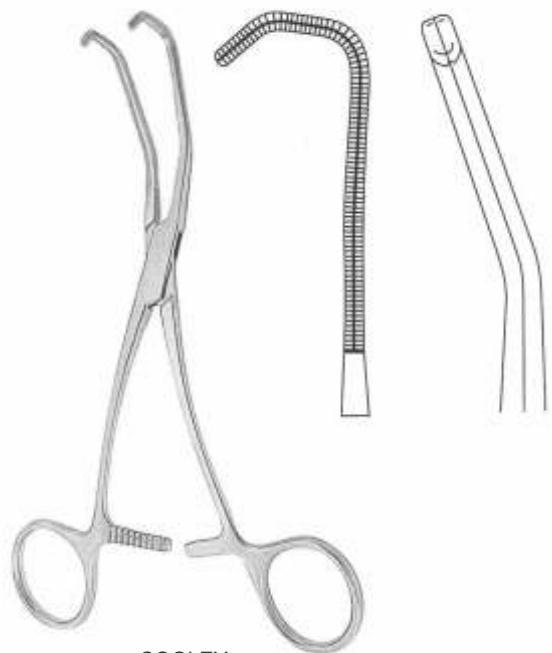

**COOLEY**  
Anastomosis Clamps  
NF.11.67.17  
17 cm/ 6¾"

# Cardiovascular Instruments

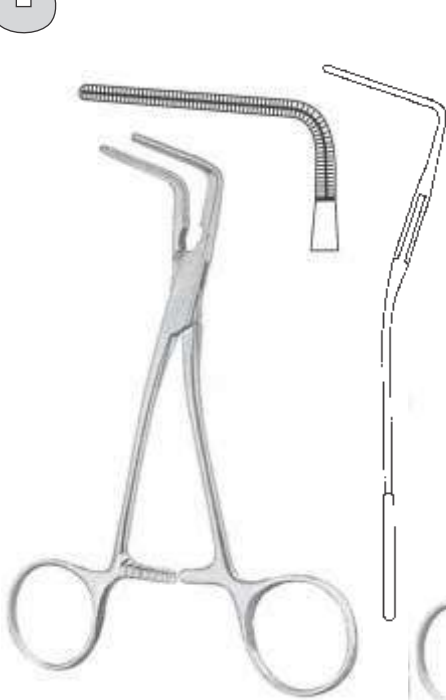

COOLEY  
NF.11.68.15  
15 cm / 6"

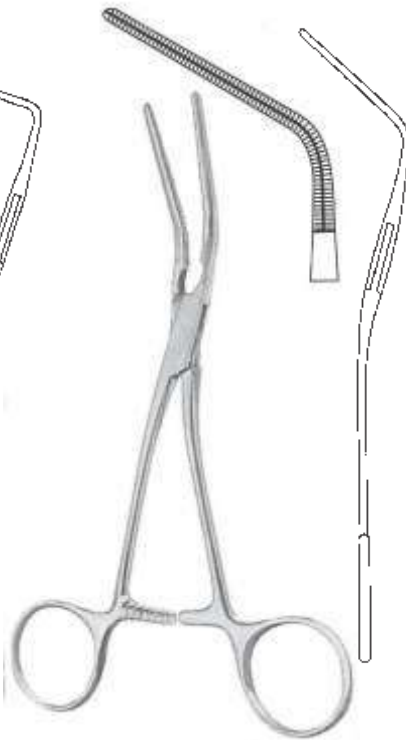

COOLEY  
NF.11.69.16  
15.5 cm / 6 1/8"

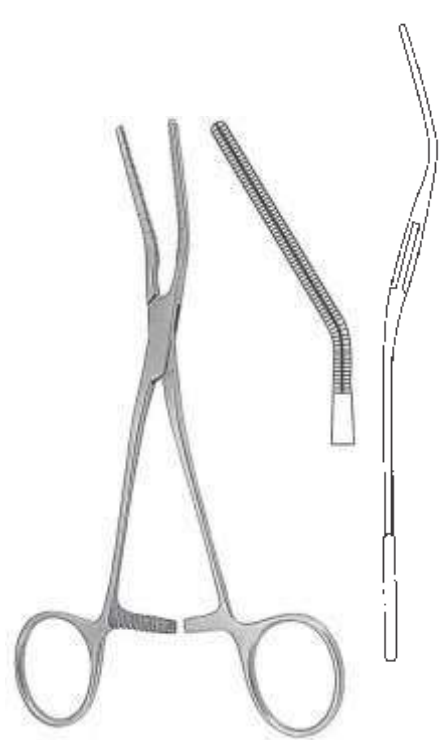

COOLEY  
NF.11.70.17  
17 cm / 6 3/4"

Multi-purpose Clamps



COOLEY  
Iliac Clamps  
NF.11.71.17  
17 cm / 6 3/4"



COOLEY  
NF.11.72.17  
17 cm / 6 3/4"



COOLEY  
Coarctation Clamps  
NF.11.73.17  
17 cm / 6 3/4"

# Cardiovascular Instruments

3



**COOLE-DERRA**  
Anastomosis Clamps

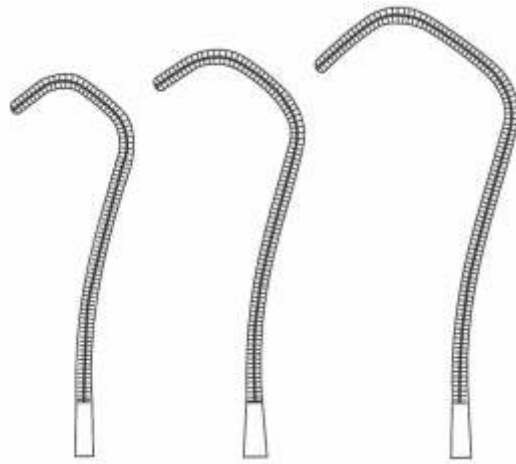

NF.11.74.16  
16 cm/ 6¼"

NF.11.74.17  
17 cm/ 6¾"

NF.11.74.18  
18 cm/ 7½"

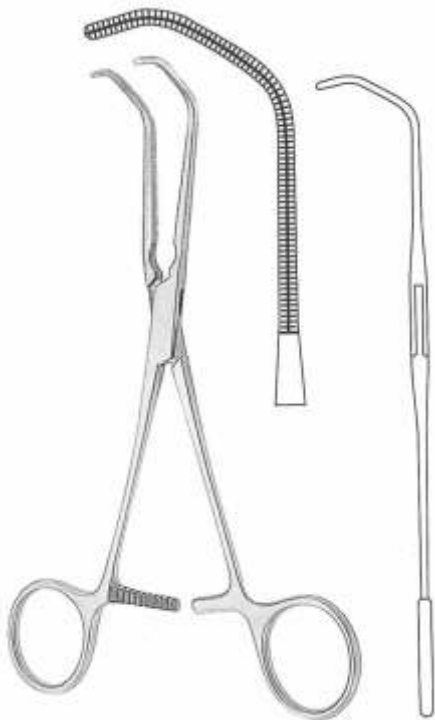

**BECK**  
NF.11.75.17  
17 cm/ 6¾"

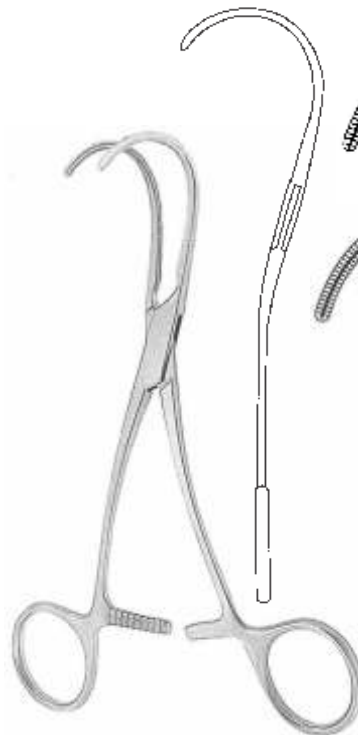

**COOLEY**  
Ligature Clamps

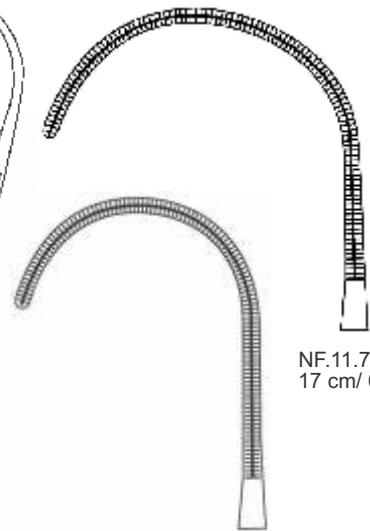

NF.11.76.17  
17 cm/ 6¾"

NF.11.76.16  
16 cm/ 6¼"

# Cardiovascular Instruments

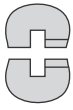

NF.11.77.14  
14 cm/ 5½"

NF.11.77.15  
14 cm/ 5½"

COOLEY



COOLEY  
NF.11.77.34  
14 cm/ 5½"



COOLEY  
NF.11.77.44  
14 cm/ 5½"

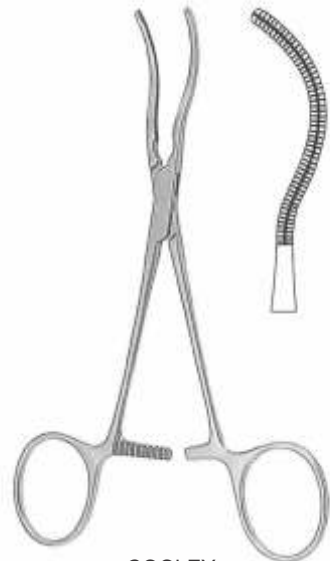

COOLEY  
NF.11.77.54  
14 cm/ 5½"

# Cardiovascular Instruments



NF.11.77.61  
13 cm/ 5 $\frac{1}{8}$ "



NF.11.77.62  
13 cm/ 5 $\frac{1}{8}$ "



NF.11.77.63  
11 cm/ 4 $\frac{1}{4}$ "



**CASTANEDA**  
Fine Neonatal Vascular Clamps

Graduated



NF.11.77.64  
12 cm/ 4 $\frac{3}{4}$ "



NF.11.77.65  
12 cm/ 4 $\frac{3}{4}$ "

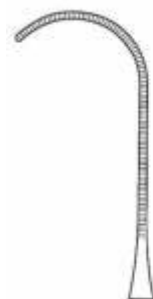

NF.11.77.66  
12 cm/ 4 $\frac{3}{4}$ "



NF.11.77.67  
12 cm/ 4 $\frac{3}{4}$ "

# Cardiovascular Instruments



## Vena-Cava Forceps



SATINSKY

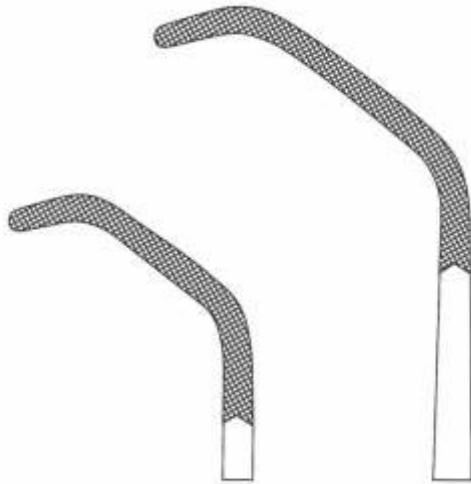

NF.11.77.70  
20 cm / 8"

NF.11.77.72  
27 cm / 10 3/4"



BABY SATINSKY  
NF.11.77.75  
15 cm / 6"



HARKEN



NF.11.77.84  
24 cm / 9 1/2"



NF.11.77.85  
24 cm / 9 1/2"

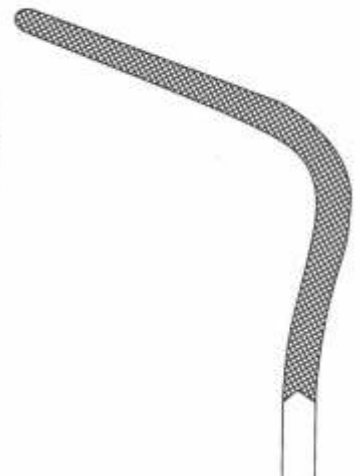

NF.11.77.94  
24 cm / 9 1/2"



# Cardiovascular Instruments

## Vascular dilators



**COOLEY**  
13 cm/ 5 1/8"

- NF.11.77.105 Ø 0.5 mm
- NF.11.77.110 Ø 1.0 mm
- NF.11.77.115 Ø 1.5 mm
- NF.11.77.120 Ø 2.0 mm
- NF.11.77.125 Ø 2.5 mm
- NF.11.77.130 Ø 3.0 mm
- NF.11.77.140 Ø 4.0 mm
- NF.11.77.150 Ø 5.0 mm



**DE BAKEY**  
19 cm/ 7 1/2"

NF.11.78.00  
Set of 12 pieces from  
NF.11.78.05 to NF.11.78.90

- NF.11.78.05 Ø 0.5 mm
- NF.11.78.10 Ø 1.0 mm
- NF.11.78.15 Ø 1.5 mm
- NF.11.78.20 Ø 2.0 mm
- NF.11.78.25 Ø 2.5 mm
- NF.11.78.30 Ø 3.0 mm
- NF.11.78.35 Ø 3.5 mm
- NF.11.78.40 Ø 4.0 mm
- NF.11.78.45 Ø 4.5 mm
- NF.11.78.50 Ø 5.0 mm
- NF.11.78.70 Ø 7.0 mm
- NF.11.78.90 Ø 9.0 mm

## Varicose vein strippers



**GARRETT**  
14 cm/ 5 1/2"

NF.11.79.190  
Set of 9 pieces from  
NF.11.79.110 to NF.11.79.150

- NF.11.79.110 Ø 1.0 mm
- NF.11.79.115 Ø 1.5 mm
- NF.11.79.120 Ø 2.0 mm
- NF.11.79.125 Ø 2.5 mm
- NF.11.79.130 Ø 3.0 mm
- NF.11.79.135 Ø 3.5 mm
- NF.11.79.140 Ø 4.0 mm
- NF.11.79.145 Ø 4.5 mm
- NF.11.79.150 Ø 5.0 mm



**GARRETT**  
21 cm/ 8 1/4"

NF.11.79.290  
Set of 9 pieces from  
NF.11.79.210 to NF.11.79.250

- NF.11.79.210 Ø 1.0 mm
- NF.11.79.215 Ø 1.5 mm
- NF.11.79.220 Ø 2.0 mm
- NF.11.79.225 Ø 2.5 mm
- NF.11.79.230 Ø 3.0 mm
- NF.11.79.235 Ø 3.5 mm
- NF.11.79.240 Ø 4.0 mm
- NF.11.79.245 Ø 4.5 mm
- NF.11.79.250 Ø 5.0 mm

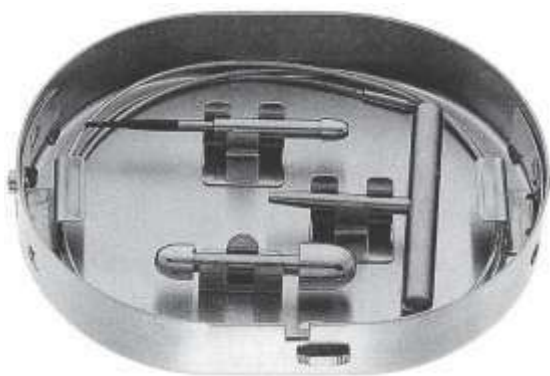

**NABATOFF**  
Complete  
PB-42.00



NF.11.47.26  
Ø 6 mm

NF.11.48.29  
Ø 9 mm

NF.11.48.32  
Ø 12 mm

NF.11.50.35  
Ø 15 mm

## MATERIAL OLIVES

**COOLEY**  
13 cm/ 5 1/8"

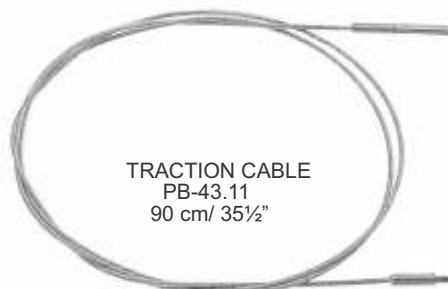

**TRACTION CABLE**  
PB-43.11  
90 cm/ 35 1/2"



**HANDLE**  
PB-44.12



**PLASTIC TIP**  
PB-45.16



**METAL TIP**  
PB-46.18  
Ø 3 mm

# Cardiovascular Instruments



# Eye Instruments



# Eye Instruments

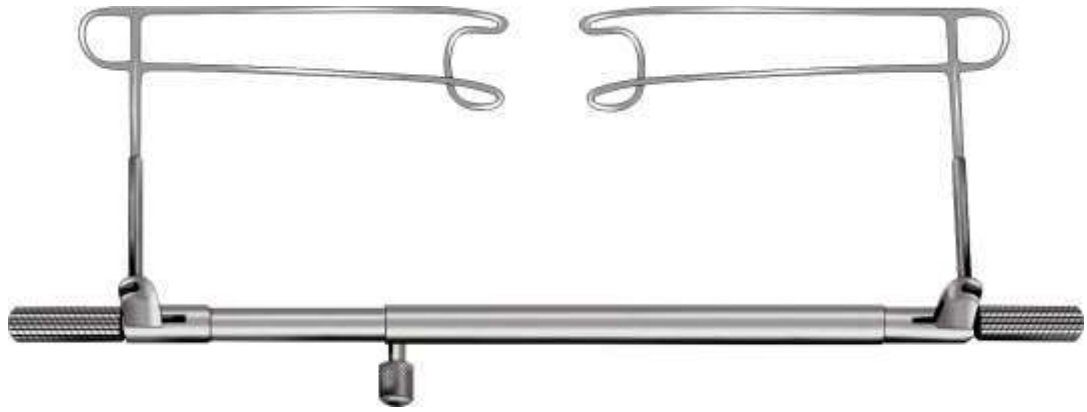

**SCHOTT EYE SPECULUM**  
Fenestrated, individually adjustable blades for controlled lid elevation  
NF.11.100.01 Adult Size  
NF.11.100.02 Child Size

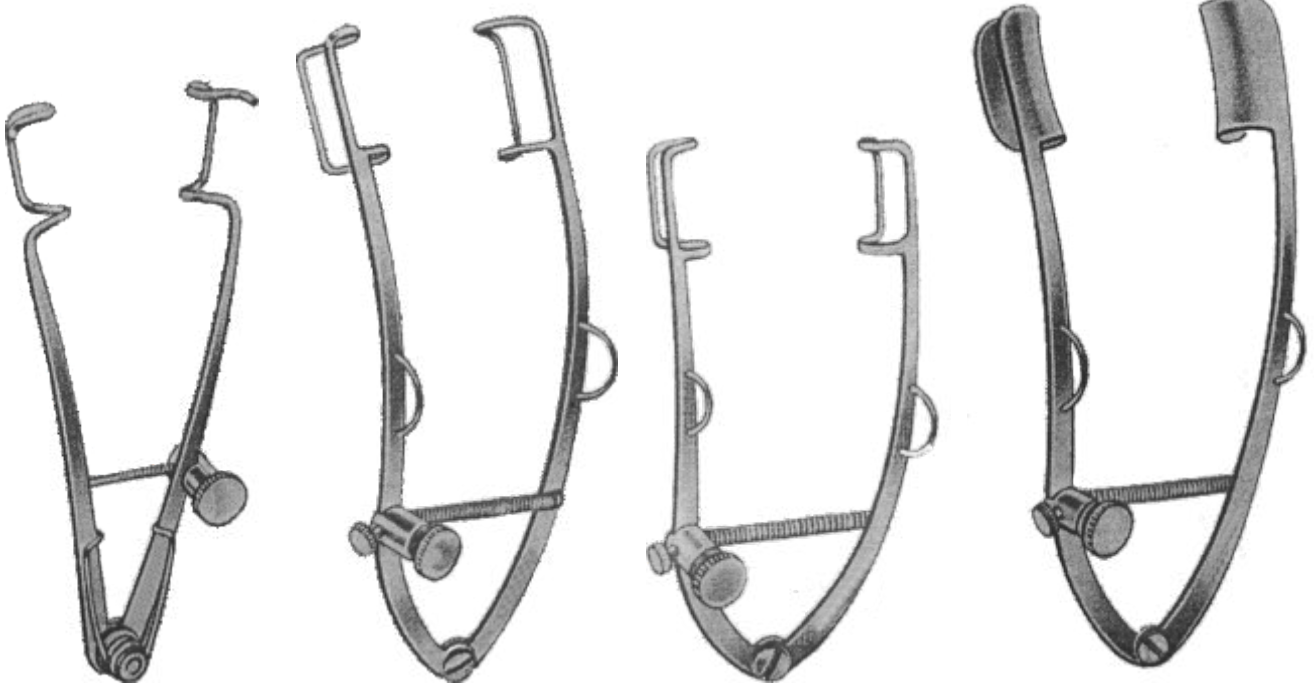

**WEISS EYE SPECULUM**  
With open blades  
NF.11.104.06

**WEISS EYE SPECULA LARGE**  
With fenestrated blades  
NF.11.105.07

**WEISS EYE SPECULA SMALL**  
With fenestrated blades  
NF.11.106.06

**WEISS EYE SPECULA LARGE**  
With solid blades  
NF.11.107.09

# Eye Instruments



**WEISS EYE SPECULA SMALL**  
With solid blades  
NF.11.108.08



**LESTER-BURCH EYE SPECULA**  
With locking screw, solid blades  
NF.11.109.14

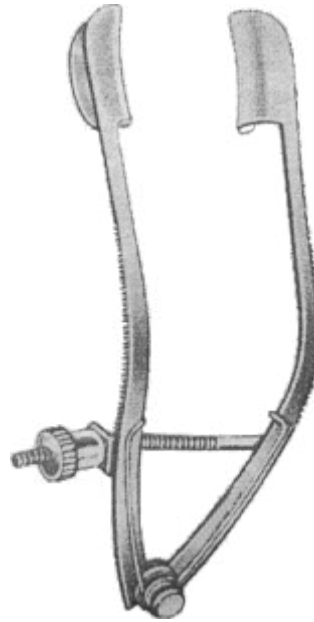

**LANCASTER EYE SPECULA**  
With locking screw, solid blades  
NF.11.110.06

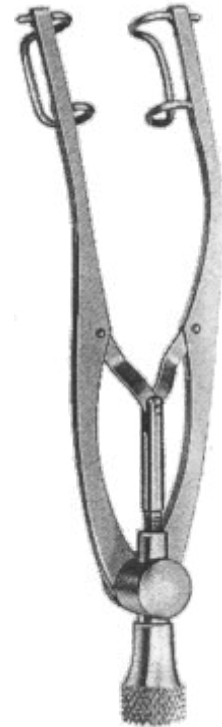

**CASTROVIEJO EYE SPECULA**  
NF.11.111.14 Small (14 mm blades)  
NF.11.112.16 Medium (16 mm blades)  
NF.11.113.18 Large (18 mm blades)

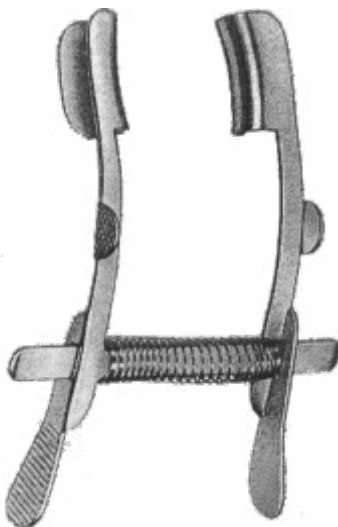

**MELLINGER-BEARD EYE SPECULA**  
With solid blades  
NF.11.114.01 Child size  
NF.11.114.02 Adult size

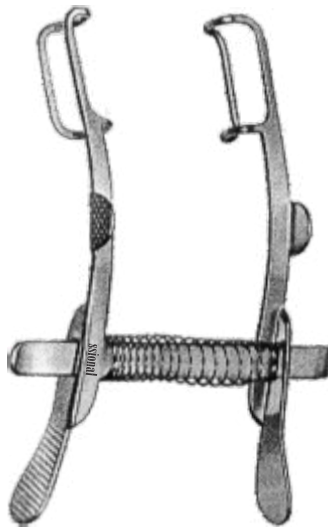

**MELLINGER EYE SPECULUM**  
With fenestrated blades  
NF.11.115.01 Child size  
NF.11.116.02 Adult size



**COOK EYE SPECULUM**  
Infant size  
NF.11.117.01



**COOK EYE SPECULUM**  
Child size  
NF.11.118.02

# Eye Instruments



**COOK EYE SPECULUM**  
Adolescent size  
NF.11.119.03

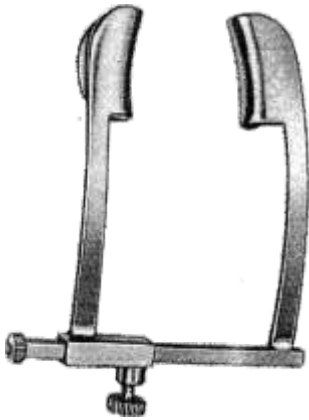

**COOK EYE SPECULUM**  
Adult size  
NF.11.120.04

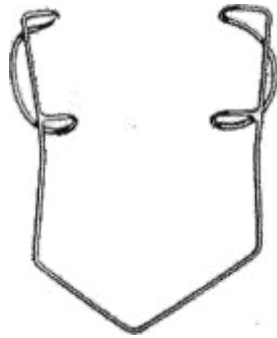

**BARRAQUER EYE SPECULUM**  
Fenestrated round blades  
NF.11.121.14 Adult size (14 mm wide)  
NF.11.122.10 Child size (10 mm wide)  
NF.11.123.05 Infant size (5 mm wide)  
NF.11.124.03 premature (3 mm wide)

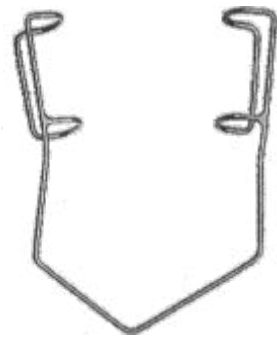

**BARRAQUER EYE SPECULUM**  
Fenestrated blades  
NF.11.122.15 Adult size (15 mm wide)  
NF.11.122.10 Child size (10 mm wide)  
NF.11.122.05 Infant size (5 mm wide)  
NF.11.122.03 Premature (3 mm wide)



**BARRAQUER EYE SPECULUM**  
Solid blades  
NF.11.123.15 Adult size (15 mm wide)  
NF.11.124.10 Child size (10 mm wide)

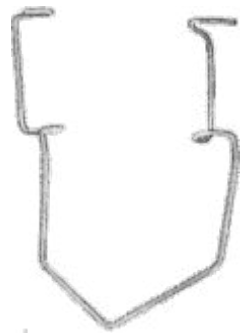

**KRATZ - BARRAQUER EYE SPECULUM**  
Open blades  
NF.11.125.01 Adult size  
NF.11.126.02 Child size  
NF.11.127.03 Heavy 1 mm model



**JAFFE LID RETRACTOR**  
With fenestrated blade, may be clamped to surgical drape with suture or elastic band  
NF.11.128.14 Adult size (14 mm wide)  
NF.11.129.10 Child size (10 mm wide)



**TENNANT LID RETRACTOR**  
With solid blade, may be clamped to surgical drape with suture or elastic band  
NF.11.130.14 Adult size (14 mm wide)



**CLAYMAN LID RETRACTOR (set of two)**  
Mobile, fenestrated blade may be clamped to surgical drape with suture or elastic band  
NF.11.131.14 Adult size (14 mm wide)



**SAUER LID SPECULUM**  
Self-retaining, with solid blades  
NF.11.132.10 Child size (10 mm wide)  
NF.11.133.06 Infant size (6 mm wide)  
NF.11.134.04 Premature (4 mm wide)

# Eye Instruments

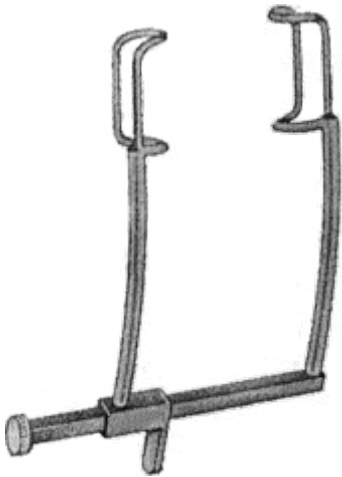

**MURDOCH EYE SPECULUM**  
With large fenestrated blades  
NF.11.135.01 Right model  
NF.11.136.02 Left model

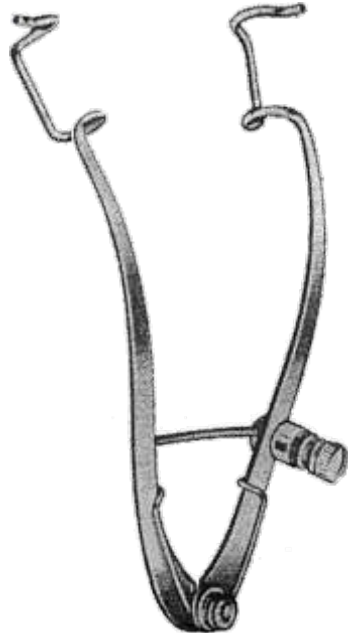

**CLARK EYE SPECULUM**  
With adjustment screw and open blades  
NF.11.137.08

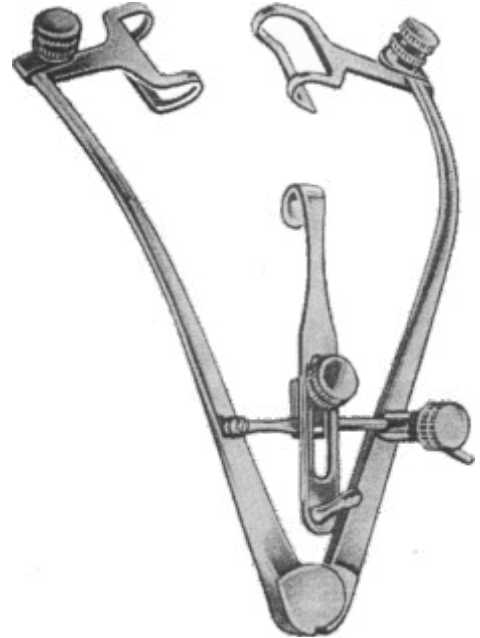

**MAUMMEE - PARK EYE SPECULUM**  
Mobile fenestrated blades with locking screw and hooked enter blade  
NF.11.138.01

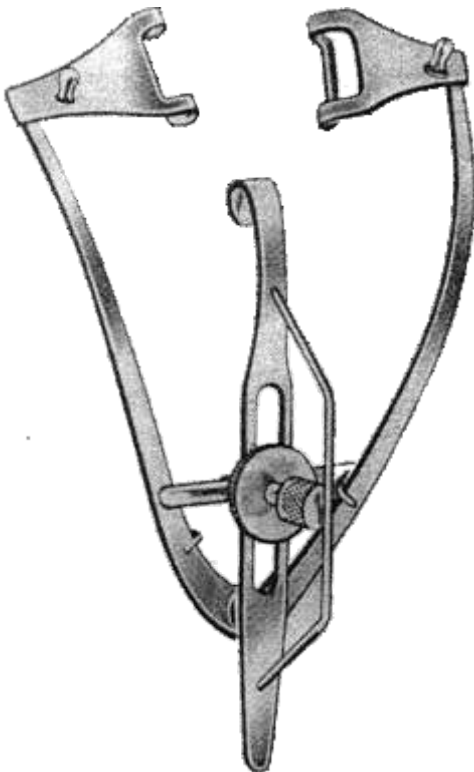

**PARK - GUYTON EYE SPECULUM**  
Mobile fenestrated blades with vertical suture posts and hooked center blade  
NF.11.139.02



**CASTROVIEJO LID CLAMP**  
With locking screw, solid blades  
NF.11.140.09

**JAEGER LID PLATE**  
Stainless steel  
NF.11.141.08

# Eye Instruments



**DESMARRES LID RETRACTOR**  
With solid blade (standard pattern)  
NF.11.143.08 8 mm wide (Conway)  
NF.11.144.10 10 mm wide # 0  
NF.11.145.12 12 mm wide # 1  
NF.11.146.14 14 mm wide # 2  
NF.11.147.16 16 mm wide # 3  
NF.11.148.18 18 mm wide # 4



**DESMARRES LID RETRACTOR**  
With fenestrated blade (new pattern)  
NF.11.149.12 12 mm wide # 1  
NF.11.150.14 14 mm wide # 2



**SWISS PATTERN DISCISSION KNIFE**  
Overall Length 120mm  
NF.11.167.12



**KNAPP DISCISSION KNIFE**  
Overall Length 120mm  
NF.11.159.50 5.0 mm blade  
NF.11.160.60 6.0 mm blade  
NF.11.161.70 7.0 mm blade



**ZIEGLER DISCISSION KNIFE**  
Overall Length 115mm  
NF.11.162.20 2.0 mm blade  
NF.11.163.30 3.0 mm blade  
NF.11.164.50 5.0 mm blade  
NF.11.165.60 6.0 mm blade



**WECKER DISCISSION KNIFE**  
Overall Length 125mm  
NF.11.166.12 Double adge



# Eye Instruments



WHEELER DISCISSION KNIFE  
Overall Length 115mm  
NF.11.168.18 18 mm cutting edge



BARKAN GONIOTOMY KNIFE  
Overall Length 120mm  
NF.11.169.12



SCHELE GONIOTOMY KNIFE  
Overall Length 125mm  
NF.11.170.12



CATARACT KNIFE  
Overall length 135mm  
NF.11.180.23 Blade 32 x 2.3 mm  
NF.11.181.26 Blade 35 x 2.6 mm  
NF.11.182.30 Blade 35 x 3.0 mm



JAEGER KERATOME ANGLED  
Overall length 135mm  
NF.11.184.10 10 x 10 mm  
NF.11.185.11 11 x 11 mm  
NF.11.186.12 12 x 12 mm  
NF.11.187.13 13 x 13 mm



DEUSCHMANN CATARACT KNIFE  
Overall Length 135mm  
NF.11.183.13

# Eye Instruments



**JAMESON MUSCLE HOOK**  
Overall length 140 mm  
NF.11.193.01 Delicate  
NF.11.194.02 Small  
NF.11.195.03 Large



**GRAEFE STRABISMUS HOOK**  
NF.11.196.01 # 1 small  
NF.11.197.02 # 2 medium  
NF.11.198.03 # 3 large



**STEVENS TENTONOMY HOOK**  
Overall Length 120 mm,  
blunt 6mm curved tip  
NF.11.199.12



**GASS RETINAL  
DETACHMENT HOOK**  
Overall length 140 mm,  
flat tip with oval hole  
NF.11.200.14



**BURCH FIXATION PICK**  
Overall length 130 mm,  
with ball stop  
NF.11.201.13



**TWIST FIXATION HOOK**  
Overall length 120 mm,  
for scleral fixation  
NF.11.202.12R Right  
NF.11.203.12L Left



**TYRELL IRIS HOOK**  
Overall length 125 mm  
NF.11.204.12 Sharp  
NF.11.205.12 Blunt

# Eye Instruments



**KNAPP LACRIMALSAC RETRACTOR**  
Overall length 135mm, 4 blunt prongs  
NF.11.206.13



**ROLLET LACRIMAL SAC RETRACTOR**  
Overall length 135mm, 4 sharp prongs  
NF.11.207.13

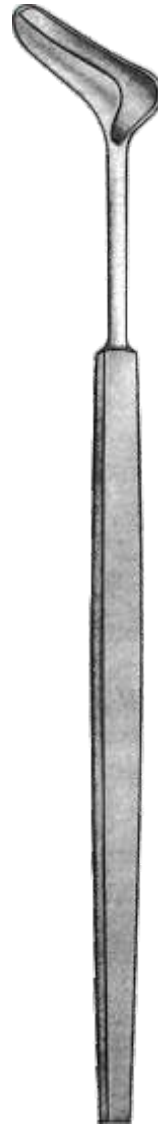

**ARRUGA GLOBE RETRACTOR**  
Overall length 145mm  
NF.11.208.14



**SCHERPENS ORBITAL RETRACTOR**  
Overall length 145mm, smooth forked blade  
NF.11.209.14

# Eye Instruments



**SNELLEN LENS LOOP**  
Overall length  
140mm  
NF.11.210.14  
15 x 4 mm  
smooth loop



**WILDER LENS LOOP**  
Overall length  
140mm  
NF.11.211.14  
15 x 4 mm  
serrated loop



**KEENER-ARHT  
LENS NUCLEUS LOOP**  
Strong curved  
3mm wide serrated  
loop for small incision  
nucleus fragment  
removal  
NF.11.212.03



**KANSAS LENS  
NUCLEUS LOOP**  
Light curved  
3 mm wide  
serrated loop  
for small incision  
nucleus fragment  
removal  
NF.11.213.03



**LEWIS LENS LOOP**  
NF.11.214.01 Small  
NF.11.215.02 Large



**MORRISON LENS  
LOOP AND PROBE**  
Very thin loop and  
delicate olive tip  
NF.11.216.02

# Eye Instruments

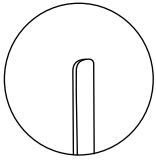

**KNOLLE LENS  
NUCLEUS SPATULA**  
Overall Length  
120 mm, flat  
0.5 mm wide blade  
NF.11.219.12

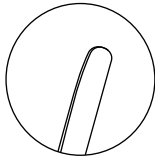

**SINSKEY LENS  
NUCLEUS SPATULA**  
Overall length  
120 mm, slightly  
curved 30 mm  
long narrow blade  
NF.11.220.12

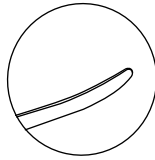

**GIRARD SYNECHIA  
SPATULA**  
Overall length  
115 mm, 0.5 mm  
wide 10mm  
vaulted blade  
NF.11.221.11

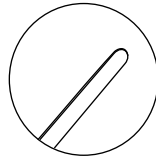

**JAFFE LENS  
SPATULA**  
Overall length  
115mm, smooth  
0.5mm wide 10 mm  
angled blade  
NF.11.222.11

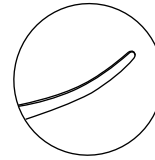

**JOHNSON SIDEPORT  
NUCLEUS SPATULA**  
Overall length  
115mm, 0.25 mm  
wide blade,  
10 mm vaulted  
shaft with sharp tip  
NF.11.223.11

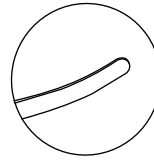

**BIRNBAUM LENS  
SPATULA**  
Overall length  
120 mm, 0.25 mm  
wide 10 mm  
vaulted blade  
NF.11.224.12



**MEYHÖFER CHALAZION CURETTE**

Overall length 130 mm,  
sharp round cup  
NF.11.248.05 ø 0.50 mm  
NF.11.249.10 ø 1.00 mm  
NF.11.250.15 ø 1.50 mm  
NF.11.251.17 ø 1.75 mm  
NF.11.252.20 ø 2.00 mm  
NF.11.253.25 ø 2.50 mm  
NF.11.254.30 ø 3.00 mm  
NF.11.255.35 ø 3.50 mm

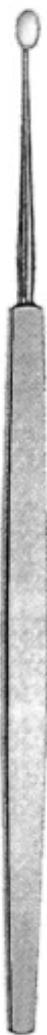

**HEBRA CHALAZION CURETTE**

Overall length 130 mm,  
sharp oval cup  
NF.11.255.10 ø 1.00 mm  
NF.11.257.20 ø 2.00 mm  
NF.11.258.25 ø 2.50 mm  
NF.11.259.30 ø 3.00 mm  
NF.11.260.35 ø 3.50 mm



**AXENFELD CHALAZION CURETTE**

Overall length  
145 mm double ended  
NF.11.261.14

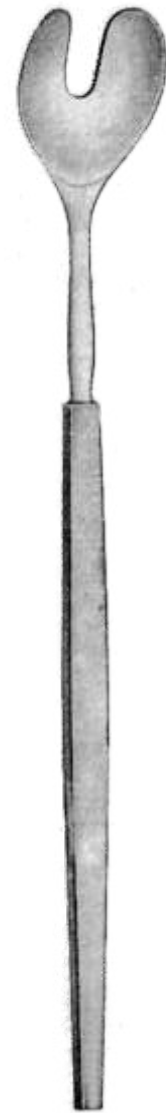

**WELLS ENUCLEATION SPOON**

Overall length 145 mm,  
21 mm wide blade with  
notch  
NF.11.269.14

# Eye Instruments

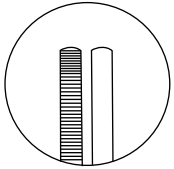

**Straight Dressing Forceps with serration**  
Overall length 100 mm  
NF.11.330.05 0.5 mm wide tips  
NF.11.330.07 0.7 mm wide tips  
NF.11.330.10 1.0 mm wide tips  
NF.11.330.12 1.2 mm wide tips  
NF.11.330.14 1.4 mm wide tips

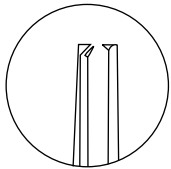

**Straight Tissue Forceps with 1 x 2 teeth**  
Overall length 100 mm  
NF.11.332.05 0.5 mm wide tips  
NF.11.332.07 0.7 mm wide tips  
NF.11.332.10 1.0 mm wide tips  
NF.11.332.12 1.2 mm wide tips  
NF.11.332.14 1.4 mm wide tips

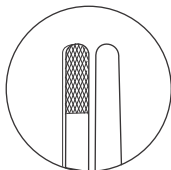

**BISHOP HARMON Dressing Forceps**  
Overall length 85 mm  
criss-cross serrated  
NF.11.333.06  
0.6 mm wide tips

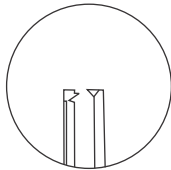

**BISHOP HARMON Tissue Forceps**  
Overall length 85 mm  
1 x 2 teeth  
NF.11.334.06 Delicate  
0.6 mm wide tips

# Eye Instruments

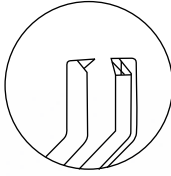

**GENTLY CURVED DRESSING**  
Forceps with serration  
Overall length 100 mm  
gently curved tips  
NF.11.335.07  
0.7 mm wide tips



**GENTLY CURVED  
TISSUE FORCEPS**  
with 1 x 2 teeth  
Overall length  
100 mm gently  
curved tips  
NF.11.336.07  
0.7 mm wide tips



**STRONG CURVED  
DRESSING FORCEPS**  
with serration  
Overall length 100 mm  
strong curved tips  
NF.11.337.07  
0.7 mm wide tips



**STRONG CURVED  
TISSUE FORCEPS**  
with 1 x 2 teeth  
Overall length 100 mm  
Strong curved tips  
NF.11.338.07  
0.7 mm wide tips



**ANGLED HESS  
IRIS FORCEPS**  
Swiss pattern  
1 x 2 teeth,  
overall length  
100 mm  
NF.11.339.10



# Eye Instruments

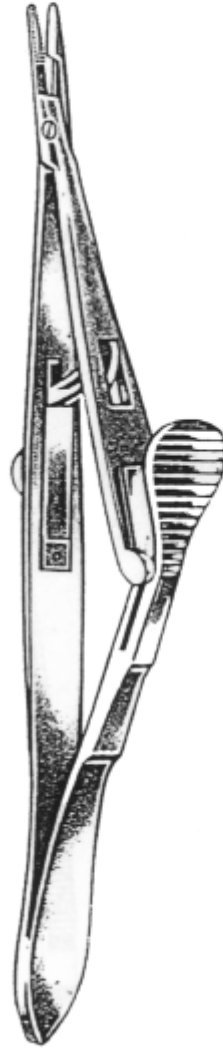
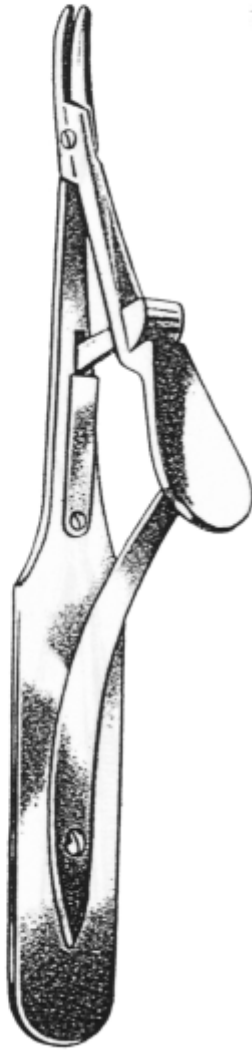
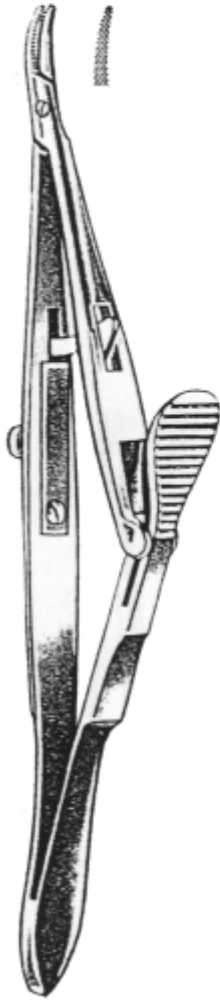

**KALT**

NF.11.550.13	NF.11.551.13
13cm/ 5½"	13cm/ 5½"
gerade	gebogen
straight	curved
recta	curva
droit	courbee

**ARRUGA**

NF.11.552.14	NF.11.553.14
14cm/ 5½"	14cm/ 5½"
gerade	gebogen
straight	curved
recta	curva
droit	courbee

**CASTROVIEJO KALT**

16cm/ 6¼"  
NF.11.555.16

**STEVENS**

14cm/ 5½"  
NF.11.554.14

# Eye Instruments

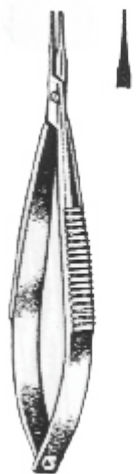

without catch

MICRO-CASTROVIEJO  
NF.11.560.09  
9cm/ 3½"



MICRO-CASTROVIEJO  
NF.11.561.09  
9cm/ 3½"

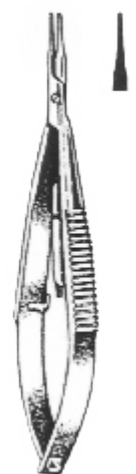

with catch

MICRO-CASTROVIEJO  
NF.11.562.09  
9cm/ 3½"

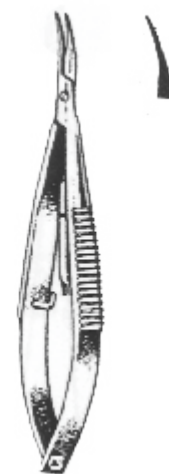

MICRO-CASTROVIEJO  
NF.11.563.09  
9cm/ 3½"



without catch

CASTROVIEJO  
NF.11.564.14  
14 cm/ 5½"

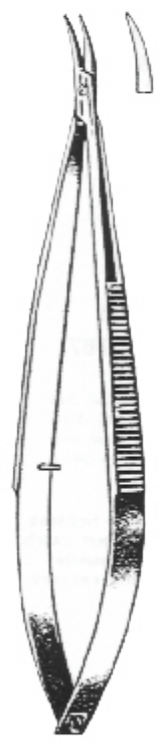

CASTROVIEJO  
NF.11.565.14  
14 cm/ 5½"

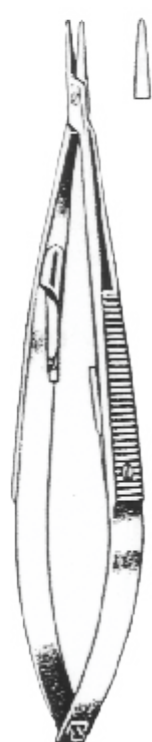

with catch

CASTROVIEJO  
NF.11.566.14  
14 cm/ 5½"

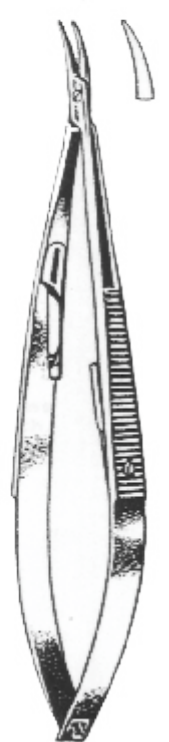

CASTROVIEJO  
NF.11.567.14  
14 cm/ 5½"

# Eye Instruments

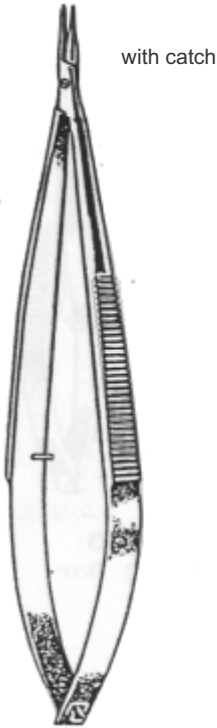

MICRO-CASTROVIEJO  
NF.11.570.14  
14cm/ 5½"

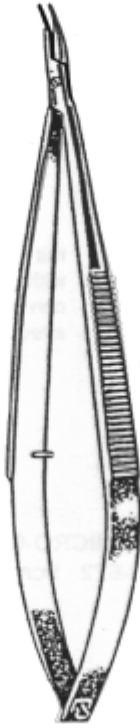

NF.11.571.14  
14cm/ 5½"

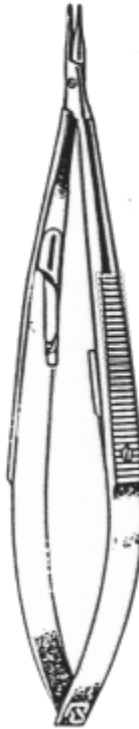

MICRO-CASTROVIEJO  
NF.11.572.14  
14cm/ 5½"

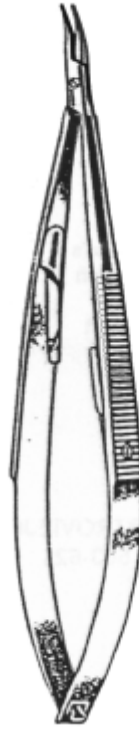

NF.11.573.14  
14cm/ 5½"

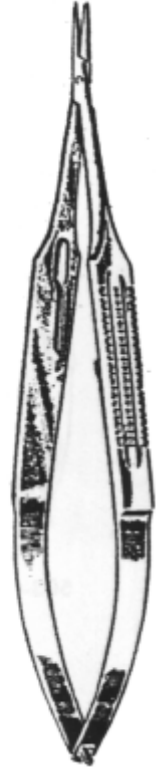

CASTROVIEJO  
NF.11.574.14  
14cm/ 5½"



NF.11.575.10  
10 cm/ 4"

without catch



BARRAQUER  
NF.11.576.13    NF.11.577.13  
13cm/ 5⅙"    13cm/ 5⅙"

without catch



BARRAQUER  
NF.11.578.13    NF.11.579.13  
13cm/ 5⅙"    13cm/ 5⅙"

with catch

# Eye Instruments



Lacrimal cannula, SS

NF.11.760.01

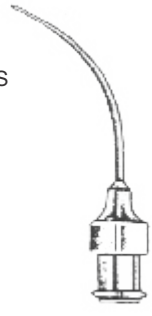

NF.11.761.01



NF.11.762.01

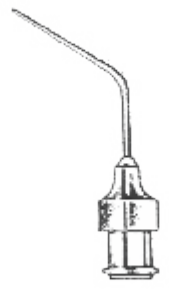

NF.11.763.01

Lacrimal cannula with 2 lateral holes



MC INTYRE  
NF.11.764.40



MC INTYRE  
NF.11.765.21

Retrobulbar needle, 40mm x 0.6mm Alpha - Chymotrypsin cannula



ATKINSON  
NF.11.766.40



TROUTMAN  
NF.11.767.01

Cyclodialysis cannula

Cyclodialysis cannula

Cyclodialysis cannula

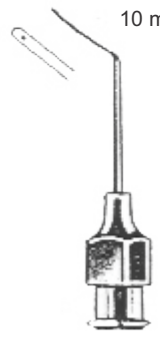

NF.11.768.10

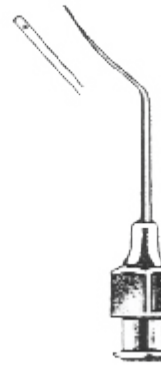

NF.11.769.15



NF.11.770.11



NF.11.771.12



NF.11.772.31

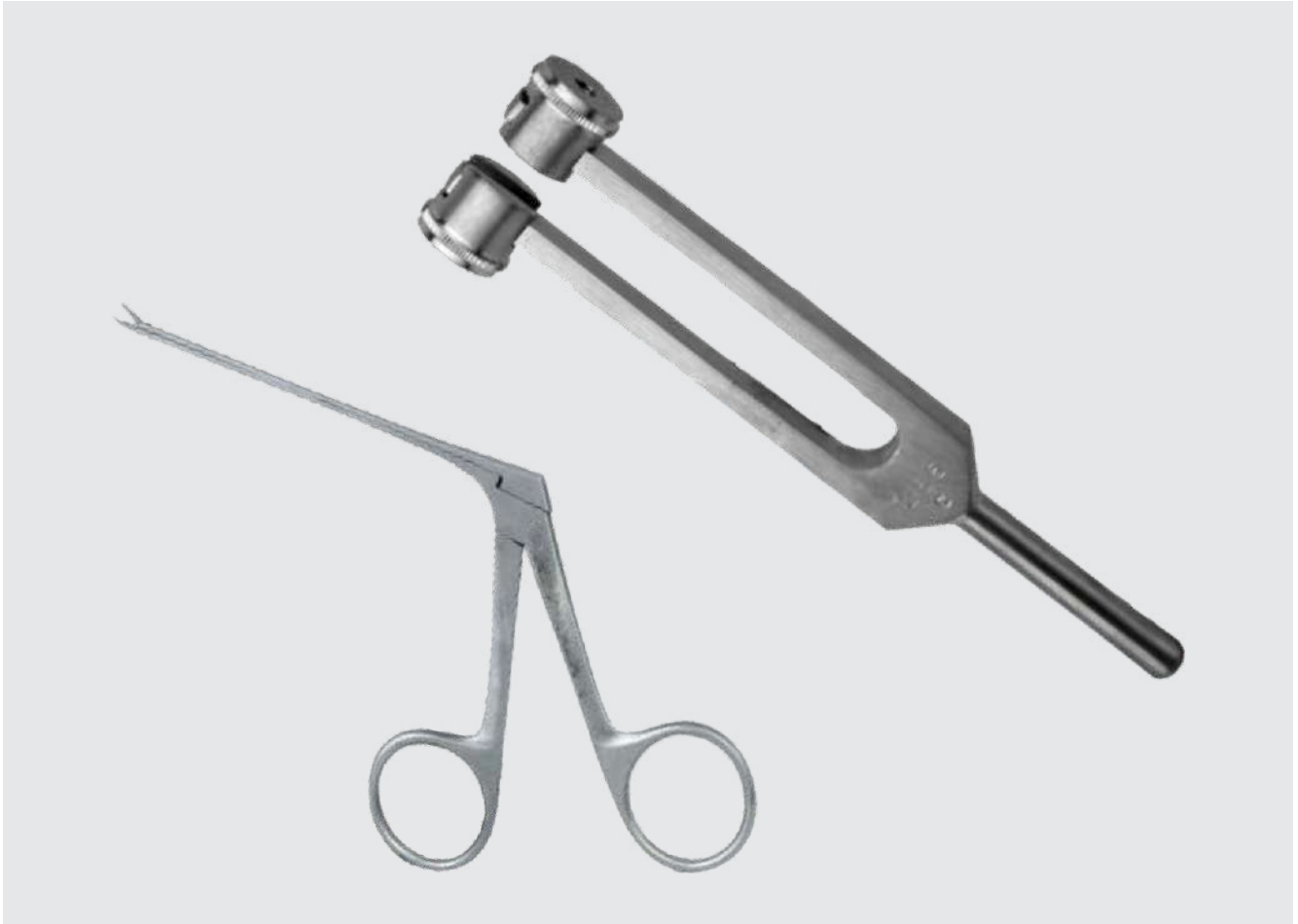

# Otology Instruments



**KRAUSE**  
NF.11.07.16  
16 cm/ 6¼"



**WILDE**  
NF.11.07.26  
16 cm/ 6¼"



**EVE**  
NF.11.07.28  
28 cm/ 11"



**EVE**  
NF.11.08.28  
28 cm/ 11"



NF.11.07.42    Ø 0.2 mm  
NF.11.07.43    Ø 0.3 mm



NF.11.07.47    Ø 0.2 mm  
NF.11.07.48    Ø 0.3 mm  
NF.11.07.49    Ø 0.35 mm

Snare wire, coli/10 meters (33.3.ft.)

Snare loops,pre-shaped, bundle/100 pieces

# Otology Instruments



NF.11.11.10  
C-128



NF.11.11.11  
C¹-256



NF.11.11.12  
C²-512



NF.11.11.13  
C³-1024



NF.11.11.14  
C⁴-2048



NF.11.11.15  
C⁵-4096

HARTMANN

ALU Tuning Forks, made of special aluminium alloy

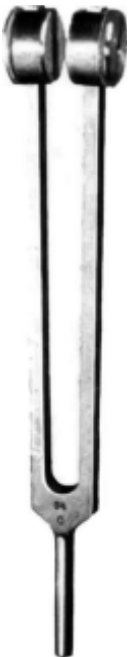

NF.11.12.64  
C-64



NF.11.13.28  
C-128



NF.11.14.56  
C¹-256



NF.11.15.12  
C²-512



NF.11.16.24  
C³-1024



NF.11.17.48  
C⁴-2048



NF.11.18.96  
C⁵-4096

ALU

# Otology Instruments



NF.11.18.10  
C-128



NF.11.18.11  
C¹-256



NF.11.18.12  
C²-512



NF.11.18.13  
C³-1024



NF.11.18.14  
C⁴-2048



NF.11.18.15  
C⁵-4096

LUCAE

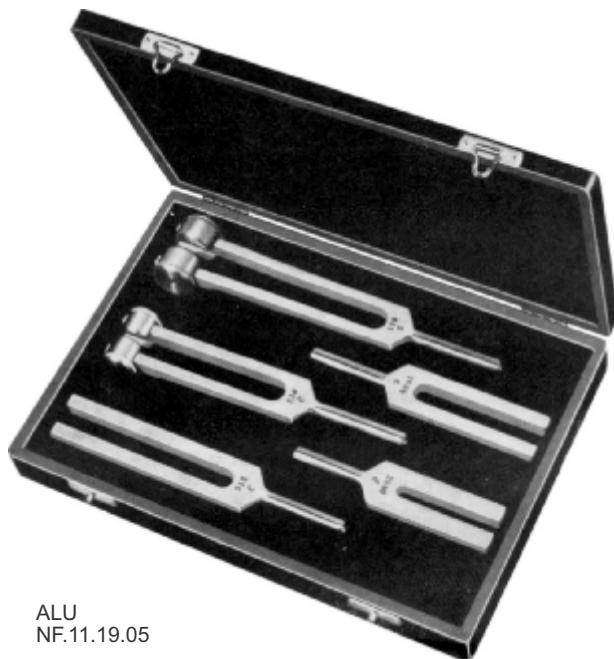

ALU  
NF.11.19.05

ALU Set of 5 Tuning Forks,  
in case, consisting of:



# Otology Instruments



GARDINER BROWN  
NF.11.19.20  
C-128



GARDINER BROWN  
NF.11.19.21  
C-256



GARDINER BROWN  
NF.11.19.22  
C-512



GARDINER BROWN  
NF.11.19.23  
C-1024

# Otology Instruments

For children



HARTMANN  
(For Children)  
NF.11.28.07  
Set of 3 (Fig

○  
NF.11.28.30  
#0 - Ø 3 mm

○  
NF.11.28.40  
#1 - Ø 4 mm

○  
NF.11.28.50  
#2 - Ø 5 mm

For adults



HARTMANN (For Adults)  
NF.11.28.03 Set of 3 (Fig 2,3,4)  
NF.11.28.04 Set of 4 (Fig 1,2,3,4)

○  
NF.11.28.40  
#1 - Ø 4 mm

○  
NF.11.28.50  
#2 - Ø 5 mm

○  
NF.11.28.60  
#3 - Ø 6 mm

○  
NF.11.28.75  
#4 - Ø 7.5 mm

For adults



HARTMANN  
(For Adults)

○  
NF.11.28.55  
#1 - Ø 5 mm

○  
NF.11.28.65  
#2 - Ø 6 mm

○  
NF.11.28.75  
#3 - Ø 7.5 mm

For adults



NF.11.28.10  
BOUCHERON

Set/4 sizes (# 1 – 4)

○  
NF.11.28.84  
#1 - Ø 4.5 mm

○  
NF.11.28.85  
#2 - Ø 5.5 mm

○  
NF.11.28.86  
#3 - Ø 6.5 mm

○  
NF.11.28.87  
#4 - Ø 7.5 mm

○  
NF.11.30.45  
#1 - Ø 4.5 mm

○  
NF.11.30.55  
#2 - Ø 5.5 mm

○  
NF.11.30.65  
#3 - Ø 6.5 mm

○  
NF.11.30.75  
#4 - Ø 7.5 mm



GRUBER  
NF.11.30.20

Set/4 sizes (# 1 – 4)

# Otology Instruments

For adults



TOYNBEE  
NF.11.32.03



NF.11.32.45  
#1 - Ø 4.5 mm



NF.11.32.55  
#2 - Ø 5.5 mm



NF.11.32.65  
#3 - Ø 6.5 mm



NF.11.32.75  
#4 - Ø 7.5 mm

For adults



TOYNBEE  
NF.11.32.04

Set/3 sizes (# 2 – 4)

Set/4 sizes (# 1 – 4)



FARRIOR  
(BLACK)  
NF.11.34.55-PAC.34.97



NF.11.34.55  
Ø 5.5 mm



NF.11.34.65  
Ø 6.5 mm



NF.11.34.75  
Ø 7.5 mm



NF.11.34.85  
Ø 8.5 mm



NF.11.34.95  
Ø 9.5 mm



NF.11.34.96  
Ø 10.5 mm



NF.11.34.97  
Ø 11.5 mm



Ø 3.0 mm  
NF.11.35.30  
Fig. 1



Ø 4.5 mm  
NF.11.35.45  
Fig. 2



Ø 5.5 mm  
NF.11.35.55  
Fig. 3



Ø 6.5 mm  
NF.11.35.65  
Fig. 4



POLITZER  
NF.11.35.51  
Set of 3 (Fig. 1,2,3)

NF.11.35.52  
Set of 4 (Fig. 1,2,3),4

# Otology Instruments



NF.11.35.70  
ZOELLNER

Set / 6 sizes (# 1 - 6)



NF.11.35.71  
#1 - 5.5 x 6.5 mm



NF.11.35.72  
#2 - 6.5 x 7.5 mm



NF.11.35.73  
#3 - 7.5 x 8.5 mm



NF.11.35.74  
#4 - 8.5 x 9.5 mm



NF.11.35.75  
#5 - 9.5 x 10.5 mm



NF.11.35.76  
#6 - 10.5 x 11.5 mm



PAPARELLA  
NF.11.35.93  
13 cm / 5 1/4"

# Otology Instruments

Length of shaft 80 mm (3 1/8")

Length of shaft 60 mm (2 1/8")



Chisel-edged punch



Atticus punch

NF.11.38.04  
4 mm

NF.11.38.06  
6 mm



# Otology Instruments



WULLSTEIN  
NF.11.54.17  
17 cm/ 6¾"

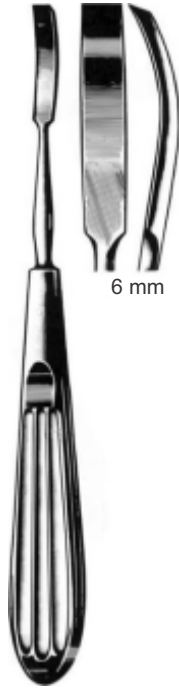

LEMPERT  
NF.11.55.17  
18 cm/ 7¼"



LEMPERT  
NF.11.54.20  
20 cm/ 8"

12mm



JANSEN  
NF.11.55.27  
17 cm/ 6¾"

13mm



VOSS  
NF.11.55.33  
15 cm/ 6"

# Otology Instruments

Periosteal Knife



MUCK  
NF.11.55.43  
13 cm - 5 1/8"

Mastoid Knife



POLITZER  
NF.11.55.53  
13 cm / 5 1/8"



LEMPERT  
18 cm - 7 1/8"



NF.11.55.62  
2 mm



NF.11.55.63  
3 mm



NF.11.55.64  
4 mm

# Otology Instruments



**HARTMANN**  
14 cm / 5½"



NF.11.63.07  
# 1 - Ø 2.5 mm



NF.11.63.09  
# 2 - Ø 3 mm



NF.11.63.11  
# 3 - Ø 3.5 mm



NF.11.63.12  
# 4 - Ø 4 mm



NF.11.63.15  
# 5 - Ø 5 mm



Graduated

**TROELTSCH**  
14 cm / 5½"



NF.11.63.21  
# 1 - Ø 2.5 mm



NF.11.63.22  
# 2 - Ø 3 mm



NF.11.63.23  
# 3 - Ø 3.5 mm



NF.11.63.24  
# 4 - Ø 4 mm



NF.11.63.25  
# 5 - Ø 5 mm



NF.11.63.30

Olive-shaped tube connector for Hartmann and troeltsch ear catheters



# Otology Instruments



WULLSTEIN  
NF.11.63.46

WULLSTEIN irrigating suction  
Handle, with Luer cone,  
For WULLSTEIN irrigating or suction tubes

#1 ●  
#2 ●

Working length 110mm-4 $\frac{3}{8}$ "



FRAZIER (FERGUSSON)  
PAC-63.51 #1-Ø 1.00 mm X 190 mm  
NF.11.63.52 #2-Ø 2.00 mm X 190 mm



With LUER cone

ZÖLLNER  
NF.11.63.61

ZÖLLNER suction tube with finger  
Plate, complete with  
1 slip-on cannula, 0.7mm diameter

Aspirating tube only  
(Without cannula)



ZÖLLNER  
NF.11.63.65 Ø 0.5mm  
NF.11.63.67 Ø 0.7mm

Micro Suction Cannula only  
for Suction Tube, working length 30 mm

# Otology Instruments



HOUSE  
NF.11.63.71 # 1 - Ø 0.9 + 0.7 mm  
NF.11.63.72 # 2 - Ø 1.2 + 0.9 mm  
NF.11.63.73 # 3 - Ø 1.5 + 1.2 mm

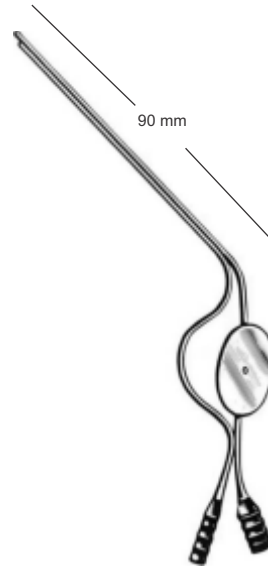

NF.11.63.81 # 1 - Ø 1.8 + 1.8 mm  
NF.11.63.82 # 2 - Ø 2.5 + 2.0 mm  
NF.11.63.83 # 3 - Ø 3.0 + 2.0 mm  
NF.11.63.84 # 4 - Ø 4.5 + 2.0 mm

For the right ear

For the left ear



HARTMANN  
NF.11.63.91  
#1



HARTMANN  
NF.11.63.92  
#2

# Otology Instruments

with LUER-LOCK attachment



**ROSEN**  
NF.11.64.01 Ø 0.70 x 80 mm  
NF.11.64.02 Ø 0.90 x 80 mm  
NF.11.64.03 Ø 1.20 x 80 mm

with LUER-LOCK attachment



**ROSEN**  
NF.11.64.11 Ø 0.70 x 65 mm  
NF.11.64.12 Ø 0.90 x 65 mm  
NF.11.64.13 Ø 1.20 x 65 mm  
NF.11.64.14 Ø 1.50 x 65 mm  
NF.11.64.15 Ø 2.00 x 65 mm

with finger cut-off

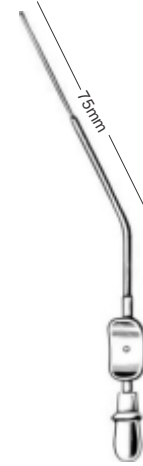

**BARON (SCHUKNECHT)**  
NF.11.64.20 Ø 1.0 x 75 mm  
NF.11.64.25 Ø 1.5 x 75 mm  
NF.11.64.30 Ø 2.0 x 75 mm



**WULLSTEIN**  
NF.11.64.41 Ø 1.5 mm  
NF.11.64.42 Ø 2.0 mm  
16 cm/ 6¼"

Flexible

With luer cone

Sterling silver



**WULLSTEIN**  
NF.11.64.43  
16 cm/ 6¼"  
Ø 1.5 mm



NF.11.64.48

Tube connector with luer cone and cut-off plate, for WULLSTEIN and ROSEN suction tubes

# Otology Instruments



NF.11.66.11  
Conical attachment only,  
With luer-lock cone



NF.11.66.12  
LUER-LOCK  
NF.11.66.02 50 ml  
NF.11.66.03 75 ml  
NF.11.66.04 100 ml

NF.11.66.12  
Olive-shaped attachment only,  
With luer-lock cone

All metal ear syringe, complete with 2 attachments  
and 1 protecting plate, with LUER LOCK attachment

NF.11.66.10  
Protective plate only, Ø 58 mm,  
With luer-lock cone

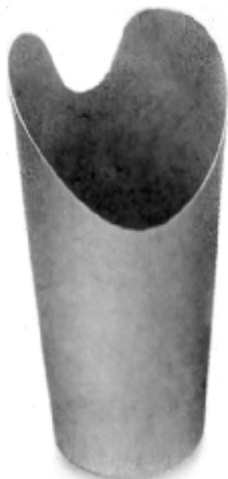















NF.11.66.50  
EAR NOOTS TANK  
Aluminium

# Otology Instruments

















BUCK  
15 cm/ 6"

sharp		blunt	
			
NF.11.70.09 # 00 - Ø 1.5 mm	NF.11.70.02 # 2 - Ø 2.7 mm	NF.11.70.29 # 00 - Ø 1.5 mm	NF.11.70.22 # 2 - Ø 2.7 mm
			
NF.11.70.00 # 0 - Ø 1.9 mm	NF.11.70.03 # 3 - Ø 3.4 mm	NF.11.70.20 # 0 - Ø 1.9 mm	NF.11.70.23 # 3 - Ø 3.4 mm
			
NF.11.70.01 # 1 - Ø 2.5 mm	NF.11.70.04 # 4 - Ø 4.0 mm	NF.11.70.21 # 1 - Ø 2.5 mm	NF.11.70.24 # 4 - Ø 4.0 mm
			
	NF.11.70.05 # 5 - Ø 4.5 mm		NF.11.70.25 # 5 - Ø 4.5 mm

Ø = Inside diameter



BUCK  
15 cm-6"

sharp		blunt	
			
NF.11.70.39 # 00 - Ø 1.5 mm	NF.11.70.42 # 2 - Ø 2.7 mm	NF.11.70.59 # 00 - Ø 1.5 mm	NF.11.70.62 # 2 - Ø 2.7 mm
			
NF.11.70.40 # 0 - Ø 1.9 mm	NF.11.70.43 # 3 - Ø 3.4 mm	NF.11.70.60 # 0 - Ø 1.9 mm	NF.11.70.63 # 3 - Ø 3.4 mm
			
NF.11.70.41 # 1 - Ø 2.5 mm	NF.11.70.44 # 4 - Ø 4.0 mm	NF.11.70.61 # 1 - Ø 2.5 mm	NF.11.70.64 # 4 - Ø 4.0 mm
			
	NF.11.70.45 # 5 - Ø 4.5 mm		NF.11.70.65 # 5 - Ø 4.5 mm

# Otology Instruments



**BUCK-WULLSTEIN MICRO**  
16 cm/ 6¼"

sharp		blunt	
○ NF.11.70.69 # 0000 Ø 0.9 mm	○ NF.11.70.72 # 0 Ø 1.8 mm	○ NF.11.70.79 # 0000 Ø 0.9 mm	○ NF.11.70.82 # 0 Ø 1.8 mm
○ NF.11.70.70 # 000 Ø 1.1 mm	○ NF.11.70.73 # 1 Ø 2.1 mm	○ NF.11.70.80 # 000 Ø 1.1 mm	○ NF.11.70.83 # 1 Ø 2.1 mm
○ NF.11.70.71 # 00 Ø 1.3 mm		○ NF.11.70.81 # 00 Ø 1.3 mm	

∅ = Inside diameter



**BILLEAU**  
15.5 cm-6¼"

- NF.11.71.10  
# 1
- NF.11.71.20  
# 2
- NF.11.71.30  
# 3



**BILLEAU MICRO**  
16 cm-6¼"

- NF.11.71.42  
# 00 - 2.0 mm
- NF.11.71.45  
# 0 - 2.5 mm
- NF.11.71.47  
# 1 - 3.0 mm

# Otology Instruments

Ear curette and hook



GROSS  
NF.11.72.35  
12 cm/ 4¾"



JANSEN  
15 cm/ 6"

Ear spoon and hook



GROSS  
NF.11.72.45  
12 cm/ 4¾"



ALLPORT  
NF.11.62.16  
16 cm/ 6¼"

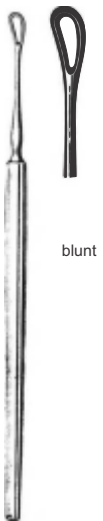

LANGENBECK  
NF.11.75.13  
13.5 cm/ 5¾"

blunt

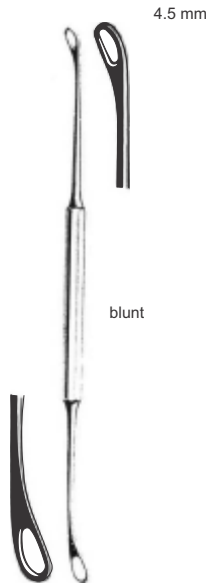

COXETER  
NF.11.75.15  
14.5 cm/ 5¾"

blunt

4.5 mm

5.5 mm



WEBER-LOCH  
15 cm/ 6"

NF.11.75.20  
# 0

NF.11.75.21  
# 1

NF.11.75.22  
# 2

Serrated

# Otology Instruments



**SHAPLEIGH**  
14 cm/ 5½"



NF.11.76.01  
# 1



NF.11.76.02  
# 2



NF.11.76.03  
# 3



NF.11.76.04  
# 4

serrated



**MOLDENHAUER**  
NF.11.77.16  
16 cm/ 6¼"



**ZAUFAL**  
NF.11.78.16  
16 cm/ 6¼"



**WAGENER**  
14 cm/ 5½"



NF.11.79.05  
2.0 mm



NF.11.79.04  
2.5 mm



NF.11.79.03  
3.0 mm



NF.11.79.02  
3.5 mm



NF.11.79.01  
4.0 mm



# Otology Instruments

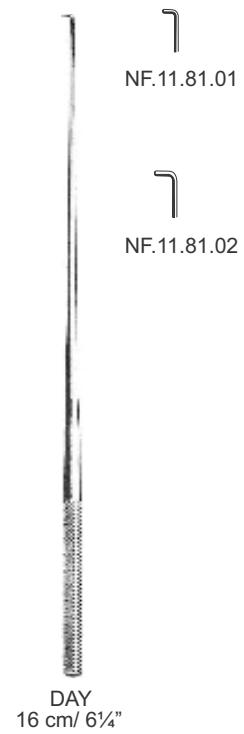
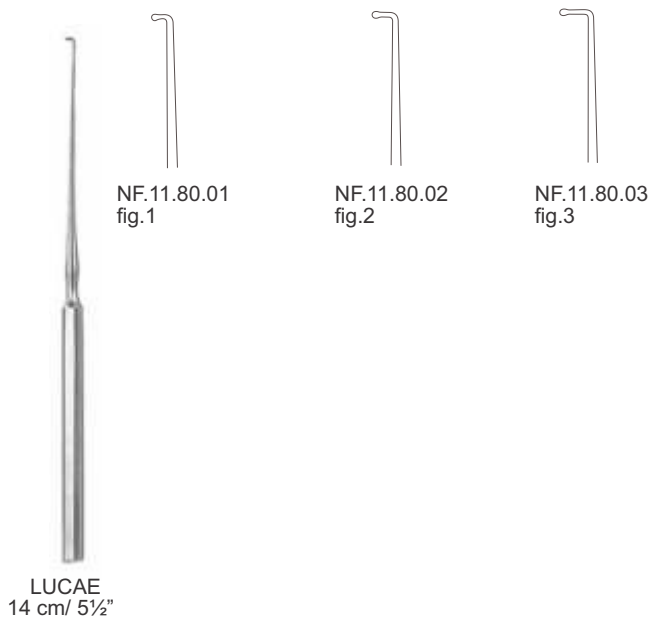
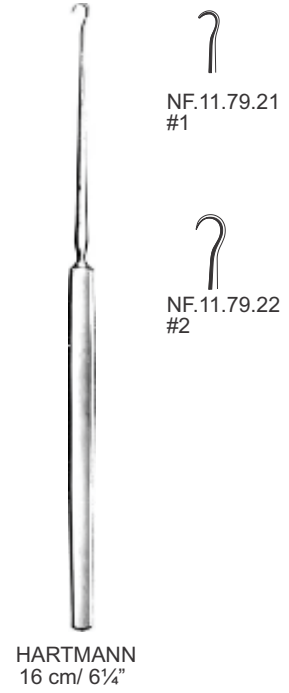

# Otology Instruments

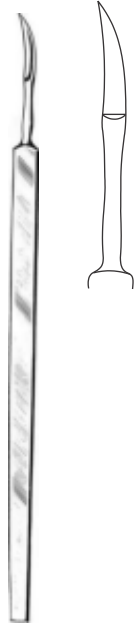

LEMPERT  
NF.11.82.16  
16cm/ 6¼"

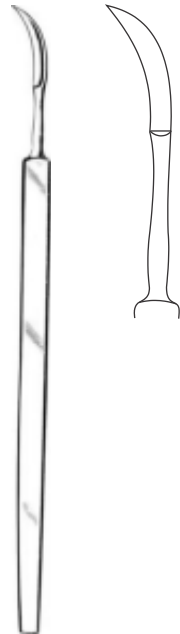

LEMPERT  
NF.11.82.17  
17cm/ 6¾"

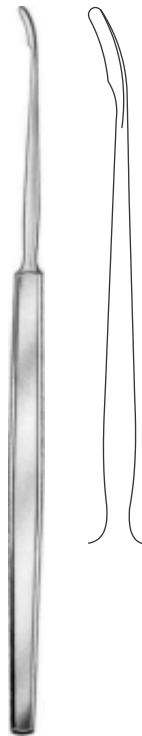

NF.11.82.19  
19cm/ 7½"

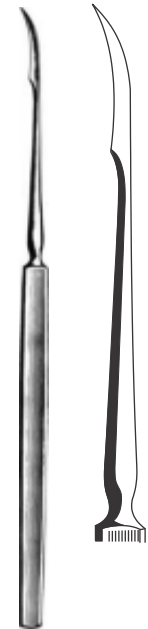

POLITZER  
NF.11.82.26  
16cm/ 6¼"

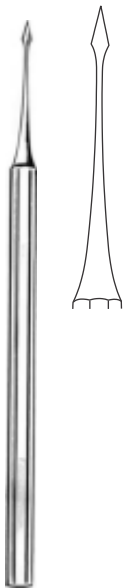

LEMPERT  
NF.11.82.35  
15cm/ 6"

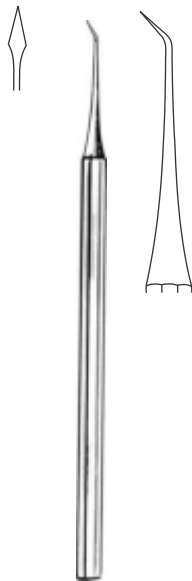

LEMPERT  
NF.11.82.45  
45°, 15cm/ 6"

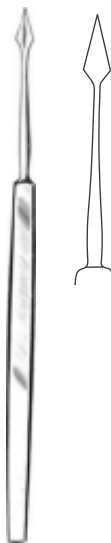

LEMPERT  
NF.11.82.54  
14cm/ 5½"

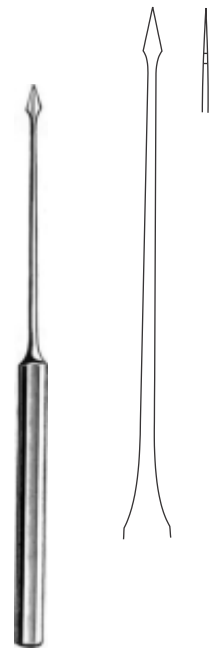

BUCK  
NF.11.82.55  
15cm/ 6"

# Otology Instruments



SEXTON  
NF.11.82.58  
18cm/ 7¼"



SEXTON  
NF.11.82.59  
18cm/ 7¼"



SEXTON  
NF.11.82.60  
18cm/ 7¼"



SEXTON  
NF.11.82.61  
18cm/ 7¼"



SEXTON  
NF.11.82.62  
18cm/ 7¼"



with screw-locking handle

SEXTON  
NF.11.82.63  
16cm/ 6¼"

# Otology Instruments



for children

**LUCÆ (ROYCE)**  
NF.11.83.07  
18cm/ 7¼"



for adults

**LUCÆ (ROYCE)**  
NF.11.83.06  
18cm/ 7¼"



**POLITZER (ROYCE)**  
NF.11.84.04  
16cm/ 6¼"



**POLITZER**  
NF.11.85.16  
16cm/ 6¼"



with screw-locking handle

**POLITZER**  
NF.11.89.20  
15cm/ 6"



**LUCÆ**  
NF.11.89.21  
19cm/ 7½"

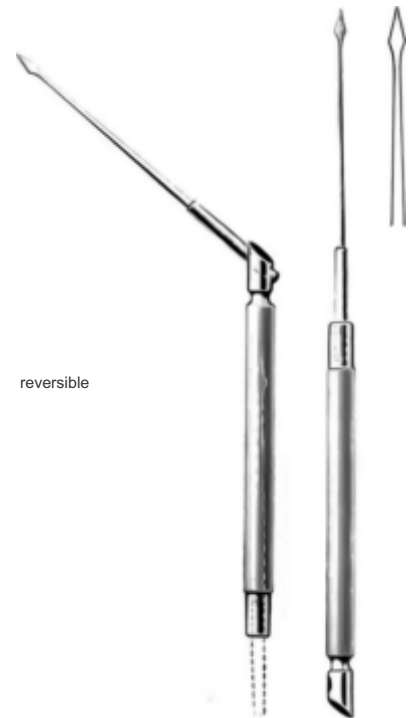

reversible

**POLITZER**  
NF.11.89.29  
19cm/ 7½"

# Otology Instruments



NF.12.90.61



NF.12.90.62



NF.12.90.63



NF.12.90.64



NF.12.90.65



NF.12.90.66

NF.12.90.60  
SPRAGUE

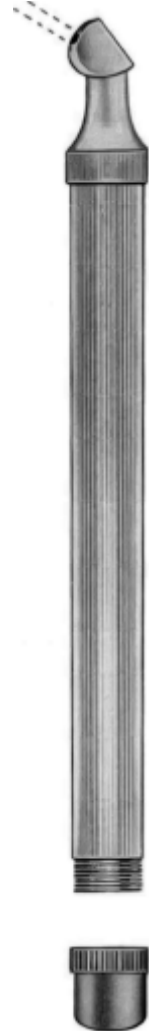

SPRAGUE Ear Instrument set, complete, composed of: 1 Tubular handle with 6 interchangeable Attachments: 1 sickle-shaped knife 1 blunt-tipped hook, no.NF.12.90.62: 1 button-tipped probe no. NF.12.90.63: 1 Tympanum perforating lancet no.NF.12.90.64: 1 ear curette no. NF.12.90.65: 1 ear spoon no.NF.12.90.66.

# Otology Instruments

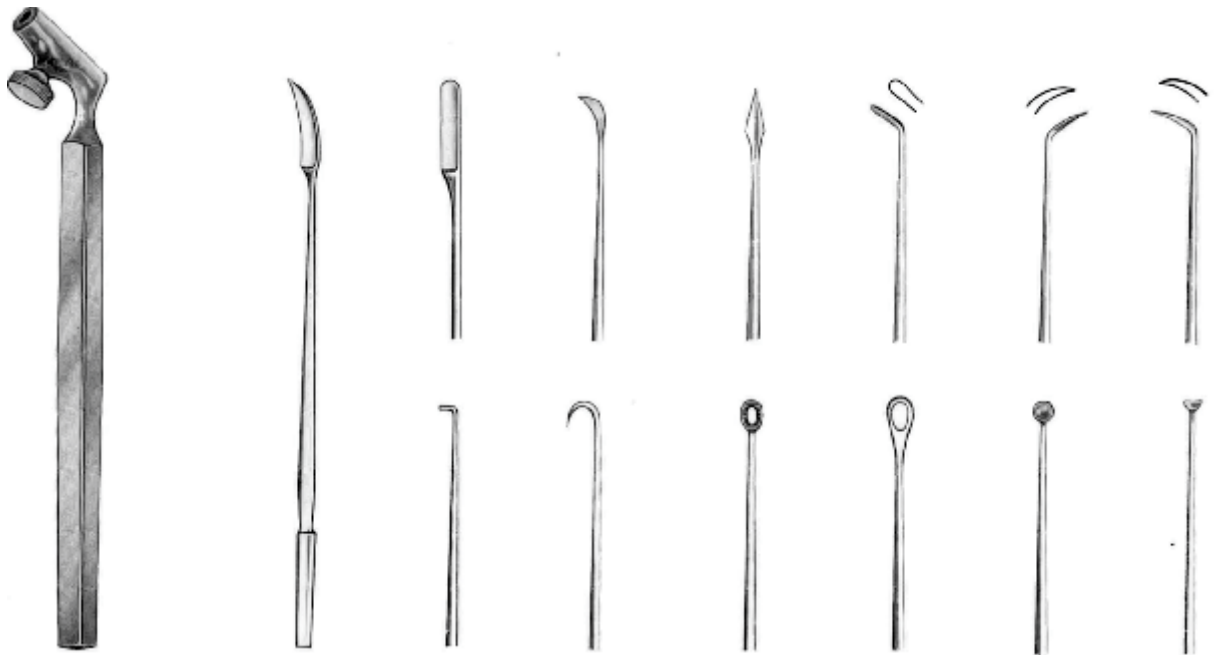

HARTMANN  
NF.12.90.76

HARTMANN ear instrument set, complete, consisting of: 1 handle and 13 interchangeable attachments, in metal case

# Otology Instruments

Foreign body forceps



**BUCK**  
NF.12.96.30  
13 cm/ 5¼"

Foreign body leaver

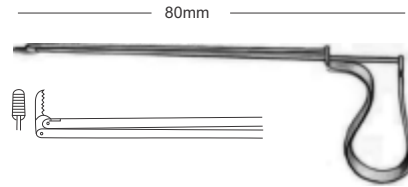

**QUIRE**  
NF.12.97.32  
10 cm/ 4"

Ear Dressing Forceps

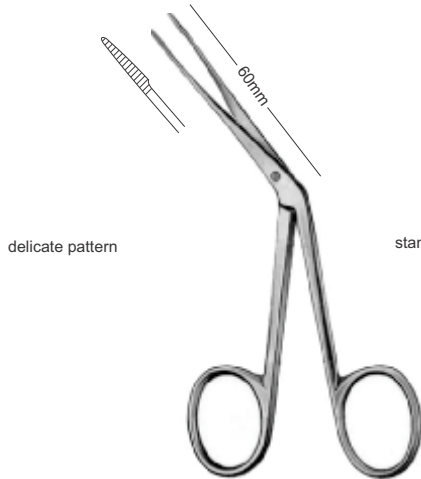

**HARTMANN**  
NF.12.105.45  
13.5 cm/ 5¼"

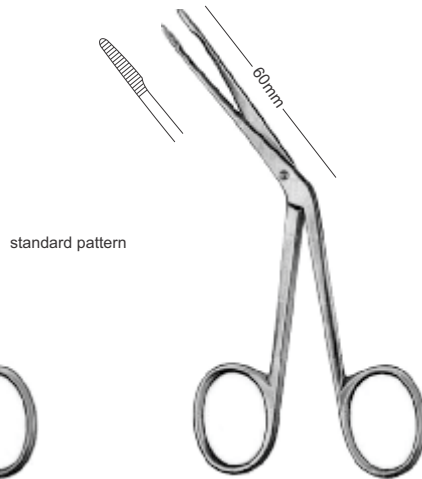

**HARTMANN**  
NF.12.105.50  
13.5 cm/ 5¼"

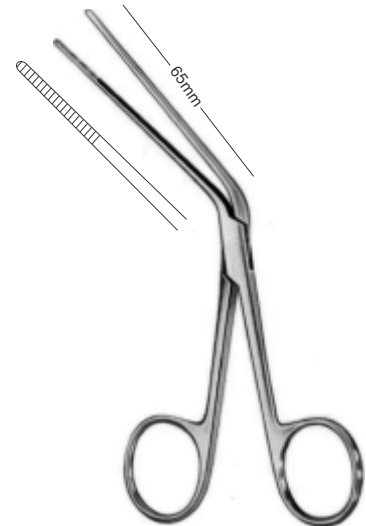

**TILLEY**  
NF.12.105.64  
14 cm/ 5½"

# Otology Instruments

medium fine  
modelo médio fino  
demi fine



HARTMANN  
NF.12.100.01  
14 cm/ 5½"  
serrated jaws



HARTMANN  
NF.12.100.02  
14 cm/ 5½"  
serrated jaws



HARTMANN  
NF.12.100.03  
14 cm/ 5½"  
smooth jaws



HARTMANN  
NF.12.100.04  
14 cm/ 5½"  
smooth jaws, 1 x 2 teeth

heavy pattern



BELLUCCI  
NF.12.101.05

Grasping Forceps, may also be used as  
Prosthesis applying forceps or as wire bending forceps.



# Otology Instruments



HARTMANN  
NF.12.103.35  
14 cm / 5½"

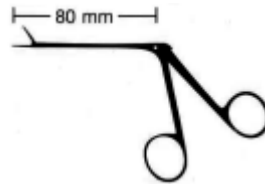

HARTMANN  
NF.12.103.37  
20 cm / 8"

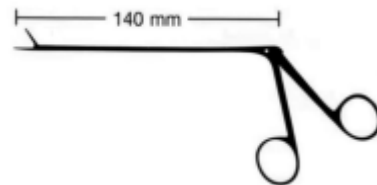

HARTMANN  
NF.12.103.38  
22 cm / 8¾"

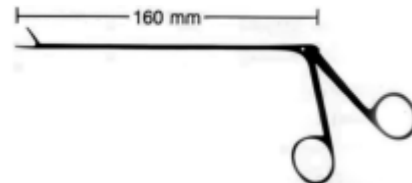

# Otology Instruments



**HARTMANN-NOYES**  
NF.12.110.09  
14 cm/ 5½"



NF.12.111.14  
14 cm/ 5½"  
"Duckbill"



**HARTMANN**  
NF.12.104.40  
14 cm/ 5½"  
1 x 2 teeth



**WEINGÄRTNER**  
NF.12.112.85  
14 cm/ 5½"



**HARTMANN-HERZFELD**  
NF.12.115.01 Ø 2 mm  
NF.12.115.02 Ø 2.2 mm  
NF.12.115.03 Ø 2.5 mm  
NF.12.115.04 Ø 3 mm  
14 cm/ 5½"



**HARTMANN-HERZFELD**  
NF.12.117.01 Ø 2 mm  
NF.12.117.02 Ø 2.2 mm  
NF.12.117.03 Ø 2.5 mm  
NF.12.117.04 Ø 3 mm  
14 cm/ 5½"

# Otology Instruments



**HARTMANN**  
NF.12.113.08  
14 cm/ 5½"



**STRUEMPEL**  
NF.12.120.08  
14 cm/ 5½"



**STRUEMPEL-BABY**  
NF.12.120.09  
14 cm/ 5½"



**HARTMANN**  
NF.12.125.08



**HARTMANN**  
NF.12.125.09



**NF.12.150.01**  
With oval cup jaws



**NF.12.150.02**  
With oval cup jaws



**NF.12.150.03**  
With oval cup jaws



**NF.12.150.04**  
With oval cup jaws

# Otology Instruments

extremely delicate

dismantable shaft



4 X 0.5 mm



NF.12.131.10  
smooth jaws

4 X 0.5 mm



NF.12.132.16  
serrated jaws

3 X 0.5 mm



NF.12.132.17  
serrated jaws

3 X 0.5 mm



NF.12.132.18  
serrated jaws

3 X 0.5 mm



NF.12.132.19  
serrated jaws

7 X 0.5 mm



NF.12.132.22  
serrated jaws

4 X 0.4 mm



NF.12.133.12  
serrated jaws

4 X 0.4 mm



NF.12.133.14  
serrated jaws

0.6 X 0.5 mm



NF.12.134.32  
with oval cup jaws

0.6 X 0.5 mm



NF.12.134.34  
with oval cup jaws

0.6 X 0.5 mm



NF.12.134.36  
with oval cup jaws

0.6 X 0.5 mm



NF.12.134.37  
with oval cup jaws

# Otology Instruments

delicate



dismantable shaft

5 X 0.5 mm



NF.12.135.12  
serrated jaws

4 X 0.5 mm



NF.12.135.14  
serrated jaws

7 X 0.5 mm



NF.12.135.33  
serrated jaws

Ø 0.9 mm



NF.12.135.40  
with oval cup jaws

1.2 X 0.9 mm



NF.12.135.25  
with oval cup jaws

5 X 2 mm



NF.12.135.30  
jaws fenestrated

# Otology Instruments

delicate



**BELLUCCI  
PAG-140.00**  
Sharp/blunt tip, straight



**BELLUCCI  
PAG-140.01**  
sharp-tipped blades, straight



**BELLUCCI  
PAG-140.02**  
sharp tips, angled up

cutting blades 4 mm long



**BELLUCCI  
PAG-140.03**  
Sharp tips, curved right



**BELLUCCI  
PAG-140.04**  
sharp tips, curved left

# Otology Instruments

delicate pattern



cutting blades 8 mm long



SHEA-BELLUCCI  
PAG-140.10  
blunt-tipped blades, straight



SHEA-BELLUCCI  
PAG-140.12  
Sharp-tipped blades, straight



SHEA-BELLUCCI  
PAG-140.16  
semisharp tips, curved right



SHEA-BELLUCCI  
PAG-140.17  
semisharp tips, curved left

# Otology Instruments

delicate

with tubular shaft



Cutting blades 4mm long



NF.12.152.01  
sharp-tipped blades, straight



NF.12.152.02  
sharp tips, angled up



NF.12.152.03  
sharp tips, curved right



NF.12.152.02  
sharp tips, curved left



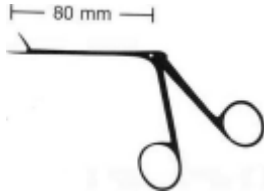

SCHUKNECHT  
NF.12.161.11

Wire crimper for closing wire loop of prostheses  
After attachment to incus or malleus.  
A groove In the rear part of the crimper jaws  
Prevents the wire loop from crushing when closing  
The forceps. Jaws slightly curved downwards

3.5 x 0.8 mm



PAG160.01

4.5 x 0.8 mm



NF.12.160.02



Dismantable shaft

MCGEE

Wire bending forceps, for application of Teflon-wire prostheses.  
Jaws slightly curved downwards.

# Otology Instruments



NF.12.170.01

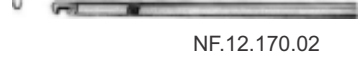

NF.12.170.02



NF.12.170.03



NF.12.170.04

3 x 2 mm



DAVOL  
NF.12.171.05



DIETER

Rongeur forceps for removing the bony Posterior canal wall for better access to incus and stapes.

Malleus punch, chisel-edge, 1.3mm wide

NF.12.170.01  
nach oben schneidend, up cutting,

NF.12.170.02  
nach unten schneidend, down cut

NF.12.170.03  
nach rechts schneidend, right cutting,

NF.12.170.04  
nach links schneidend, left cutting,



LEMPERT  
NF.12.172.11  
11.5 cm/ 4½"

Malleus forceps



WULLSTEIN  
NF.12.172.35  
15 cm/ 6"

Malleus nipper,  
Chisel edge 3 mm long,  
Length of shaft 80mm (3½")

# Otology Instruments



FULLER  
NF.12.173.19

Forceps for holding and inserting stapedial prostheses of Teflon, Plain jaws 6 x 0.8mm, length of shaft 75mm (3")



GREVEN  
NF.12.173.30

Grasping forceps for the removal of otosclerotic proliferations (also, suitable for inserting Prostheses into the inner ear and for setting Drainage buttons), front part of jaws serrated, 3 x 1 mm, length of shaft 70 mm ( 2 ¾)



TABB  
NF.12.173.22

Tabb crura nipper alligator type, for crurotomy And removal of footplate fragments in the oval Window area, width of shaft 1.5mm, usable length of shaft 65 mm

# Otology Instruments



**ANTOLI-CANDELA**  
NF.12.200.10 Ø 1.0 mm  
NF.12.200.15 Ø 1.5 mm  
NF.12.200.20 Ø 2.0 mm  
NF.12.200.23 Ø 2.3 mm  
NF.12.200.25 Ø 2.5 mm

Incision Knife

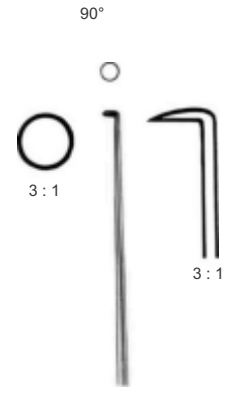

NF.12.200.30 Ø 1.0 mm  
NF.12.200.35 Ø 1.5 mm  
NF.12.200.40 Ø 2.0 mm  
NF.12.200.43 Ø 2.3 mm  
NF.12.200.45 Ø 2.5 mm

Circular cutting knife

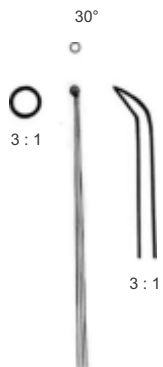

**HOUSE**  
NF.12.201.01  
Ø 1.0 mm

Round knife for incudo-stapedial joint

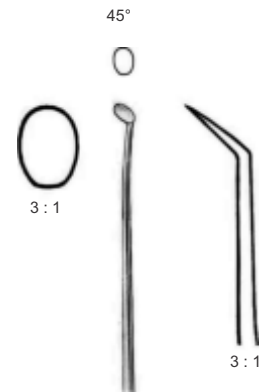

**GOLDMANN**  
NF.12.201.03  
Ø 3.0 mm

Knife-elevator for meatal wall

# Otology Instruments



Knife-Curette



Round knife for incudo-stapedial joint

# Otology Instruments

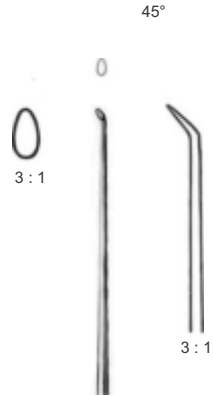

SHEA  
NF.12.210.35  
1.5 X 1 mm

Knife for anterior crurotomy

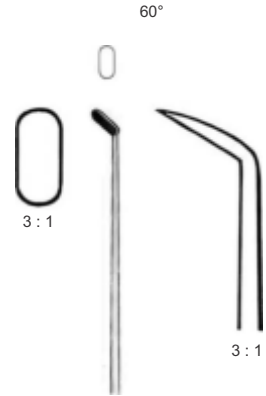

NF.12.210.38  
4.0 X 2.5 mm

Knife for incising skin of external

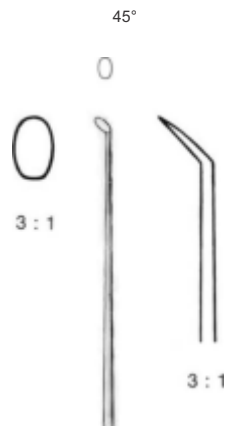

HARRISON  
NF.12.210.39

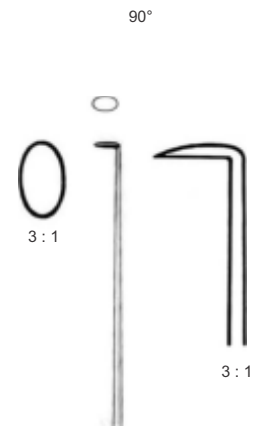

HARRISON  
NF.12.210.47

Knife for the tympanic membrane

# Otology Instruments

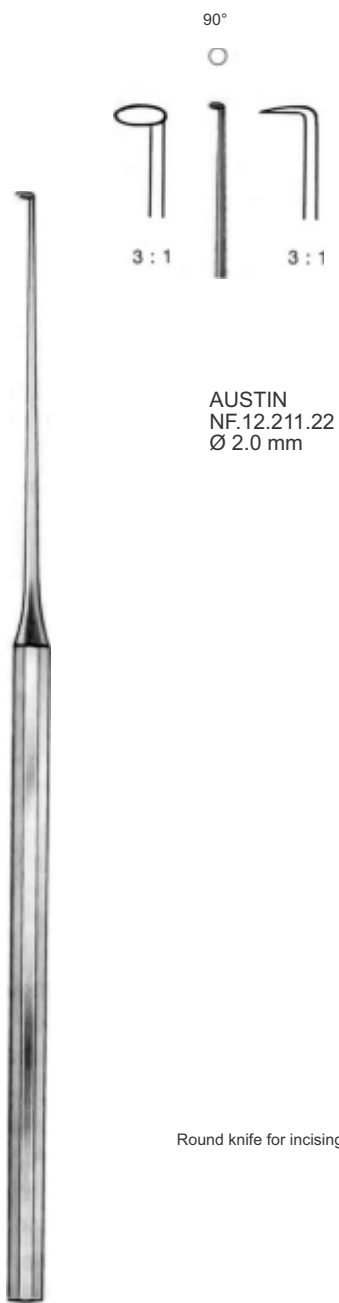

Round knife for incising skin

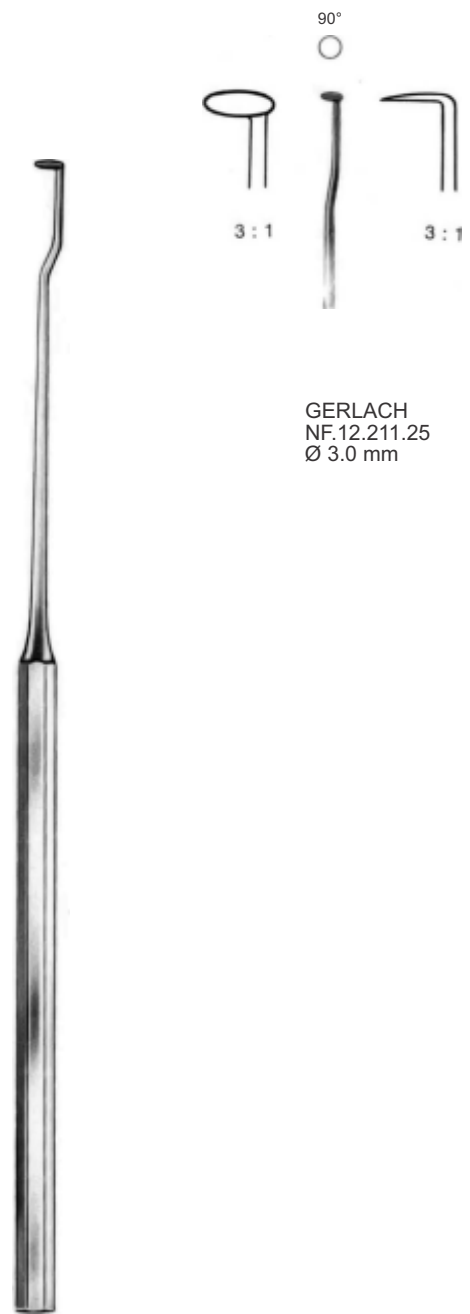



# Otology Instruments

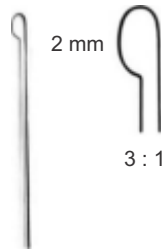

GUILFORD-WRIGHT  
NF.12.212.03

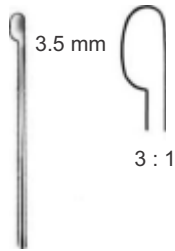

PLESTER  
NF.12.212.05

Flap knife

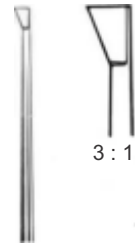

NF.12.212.17  
2.5 mm

Incision Knife



AUSTIN  
NF.12.212.32  
3.0 X 1.0 mm

Sickle Knife



NF.12.212.35

Discision knife for the footplate

# Otology Instruments

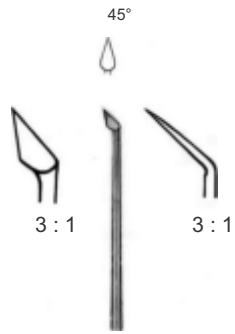

ROSEN  
NF.12.213.53

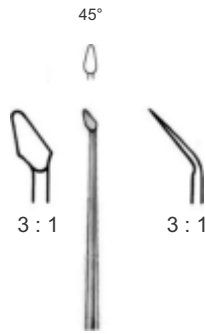

HOUGH  
NF.12.213.55  
2.0 x 1 - 2 mm



HOUSE  
NF.12.213.58  
2.0 X 1.0 mm

Incision knife

Lancet knife no. 2

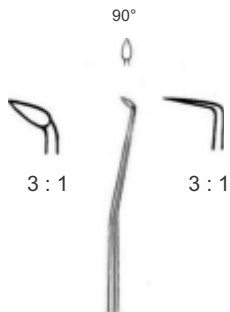

SHEA  
NF.12.213.65  
2.0 X 1.5 mm

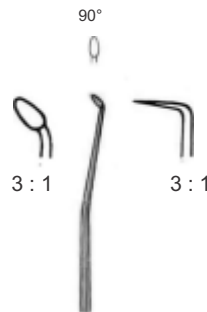

AUSTIN  
NF.12.213.67  
1.8 X 1.2 mm

Incision knife

# Otology Instruments

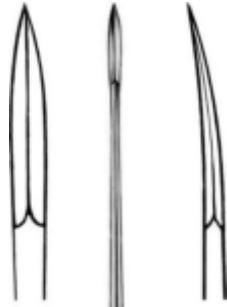

3 : 1                      3 : 1

HOUSE  
NF.12.214.61  
4.0 x 1.0 mm

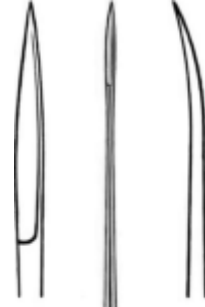

3 : 1                      3 : 1

NF.12.214.63  
3.0 x 1.0 mm

Tympanoplasty knife, also used to excavate around  
The malleus to open for prosthesis

Stapedius tendon knife



2 : 1

GRAY  
NF.12.214.75  
Ø 3.5 mm

Rotary knife for first incision in stapes  
Mobilization

# Otology Instruments



TABB  
NF.12.215.40  
1.5 X 1 - 1.5 mm

Knife for the mucosa and tympanoplasty



SCHUKNECHT  
NF.12.215.46  
5.0 X 1.0 mm

Sickle knife



HOUSE  
NF.12.215.41  
6.0 x 1.5 mm

Sickle knife no.1

# Otology Instruments

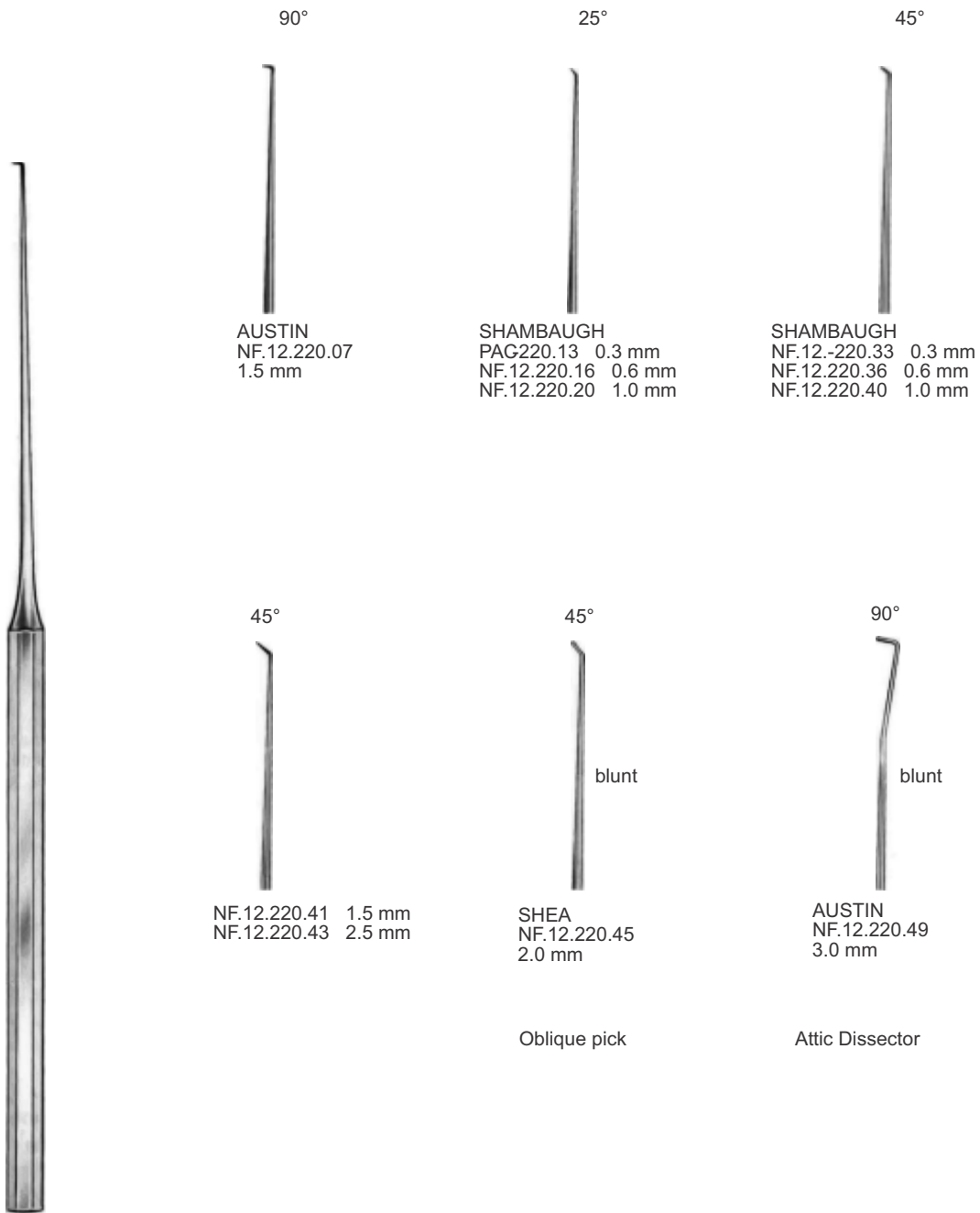

# Otology Instruments



sharp

BARBARA  
NF.12.221.01



sharp

NF.12.221.03



sharp

ROSEN  
NF.12.221.04



blunt

NF.12.221.05



blunt

NF.12.221.06

# Otology Instruments

Angled up

Angled down



25°



NF.12.222.13 0.3 mm  
NF.12.222.14 0.6 mm  
NF.12.222.20 1.0 mm



NF.12.222.23 0.3 mm  
NF.12.222.26 0.6 mm  
NF.12.222.30 1.0 mm

45°



NF.12.222.33 0.3 mm  
NF.12.222.36 0.6 mm  
NF.12.222.40 1.0 mm



NF.12.222.43 0.3 mm  
NF.12.222.46 0.6 mm  
NF.12.222.50 1.0 mm

90°



NF.12.222.53 0.3 mm  
NF.12.222.56 0.6 mm  
NF.12.222.60 1.0 mm



NF.12.222.63 0.3 mm  
NF.12.222.66 0.6 mm  
NF.12.222.70 1.0 mm

# Otology Instruments

90°



SHAMBAUGH  
PAG223.53 0.3 mm  
NF.12.223.56 0.6 mm  
NF.12.223.58 0.8 mm  
NF.12.223.60 1.0 mm



SHAMBAUGH  
PAG223.62 1.2 mm  
NF.12.223.65 1.5 mm  
NF.12.223.74 2.5 mm



NF.12.223.75 0.5 mm  
NF.12.223.80 1.0 mm



GOLDMANN  
NF.12.223.85

Retractor for malleus



PLESTER  
NF.12.223.90

For roughening the back of the  
Tympanic membrane



sharp

ROSEN  
NF.12.223.95

Oval window fenestración



# Otology Instruments

curved up

curved down



MCGEE  
NF.12.225.75 0.5 mm  
NF.12.225.80 1.0 mm



MCGEE  
NF.12.225.85 0.5 mm  
NF.12.225.90 1.0 mm



FISCH  
NF.12.225.92 0.2 mm

PLESTER  
NF.12.225.96 0.6 mm

Footplate hook

# Otology Instruments

angled right

angled left



ANTOLI-CANDELA  
NF.12.226.72  
0.6 mm

90°



ANTOLI-CANDELA  
NF.12.226.73  
0.6 mm



NF.12.226.92  
1.0 mm

90°



NF.12.226.93  
1.0 mm

# Otology Instruments



AUSTIN  
NF.12.230.22

Raspatory (Round knife),  
Ø 2 mm, angled up 90°



ANTOLI-CANDELA  
NF.12.230.23

Elevator (Raspatory) for  
Dissection of soft tissue,  
1.8 mm wide, curved



ROSEN  
NF.12.230.25



ROSEN  
NF.12.230.31



ROSEN  
NF.12.230.32

# Otology Instruments



**GOLDMANN**  
NF.12.231.03

Elevator and dissecting knife for soft Tissues, oval shape, 2.5 mm wide, Light curve



**HOUSE**  
NF.12.231.11

Stapes-elevator, blade 12 mm long, 1 mm wide, slightly angled up



**SHEA**  
NF.12.231.31

Right  
Direito  
Droit

1.2 mm



**SHEA**  
NF.12.231.32

Left  
Esquerdo  
Gauche



1.5 mm

blunt



**SHAMBAUGH-DERLACKI**  
NF.12.231.71  
14 cm/ 5½"

# Otology Instruments



SHAMBAUGH-DERLACKI  
NF.12.232.75  
14.5 cm/ 5¾"

Elevator (Raspatory), 2, 0 mm wide,  
Angled tip



SHAMBAUGH-DERLACKI  
NF.12.232.76  
14.5 cm/ 5¾"

Duckbill Elevator (Raspatory)  
3 mm wide, slightly curved

# Otology Instruments



SCHUKNECHT  
NF.12.233.43

Mucosa Elevator, flat, 1 mm wide,  
tip slightly curved up



HOUGH  
NF.12.233.50



HOUGH  
NF.12.233.51

Excavator for oval window, heavy pattern

# Otology Instruments

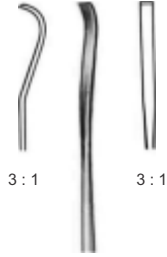

ROSEN  
NF.12.235.61

Mobilizer, 1.8mm wide



GOLDMANN  
NF.12.235.65

Mobilizer with ball tip,  $\varnothing$  0.8 mm,  
Angled up 25°



GOLDMANN  
NF.12.235.68

Plugger with ball tip,  $\varnothing$  1.0 mm,  
For placing implant material

# Otology Instruments



ANTOLI-CANDELA  
NF.12.236.05

Measuring rod, markers at 4.0 mm,  
4.5 mm and 5 mm



HOUGH  
NF.12.236.10

Measuring rod, markers at 3.5 mm,  
4 mm and 4.5 mm



AUSTIN  
NF.12.236.15

Measuring and introduction probe for incudo  
Stapedial prostheses, marking at 3.5 4 and 4.5 mm



NF.12.236.33

Wire guide and applicator for prosthesis,  
V-notch , light curve



# Otology Instruments



Ø 1.0 mm



GUILFORD-WRIGHT  
NF.12.238.10

Ø 1.5 mm



GUILFORD-WRIGHT  
NF.12.238.15

2 mm

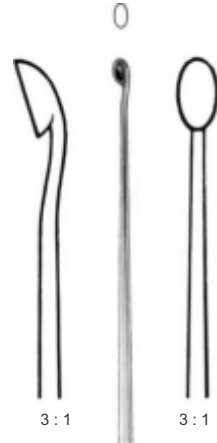

ROSEN  
NF.12.238.27

Curette, for tympanoplasty and myringoplasty

1.3 mm



GUILFORD-WRIGHT  
NF.12.238.31

1.3 mm

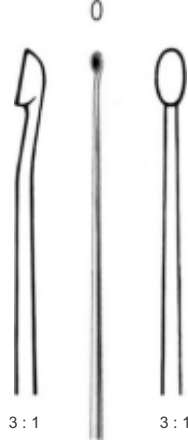

GUILFORD-WRIGHT  
NF.12.238.33

Curette, for tympanoplasty and myringoplasty

# Otology Instruments



AUSTIN  
NF.12.239.40  
45°, 0.8 X 0.5 mm



HOUSE  
NF.12.239.41  
90°, 0.8 mm

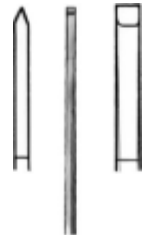

AUSTIN  
NF.12.239.65  
1 mm



right

HOUGH  
NF.12.239.52  
# 3



left

HOUGH  
NF.12.239.53  
# 4



right

AUSTIN  
NF.12.239.54



left

AUSTIN  
NF.12.239.55



# Otology Instruments

Ø 1.0 mm

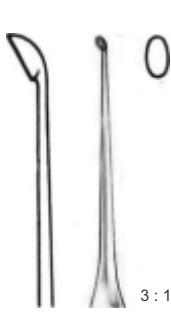

HOUSE  
NF.12.240.70

Ø 1.5 mm



HOUSE  
NF.12.240.75

Ø 1.0 mm



HOUSE  
NF.12.240.80

Ø 1.5 mm

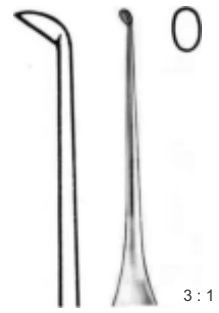

HOUSE  
NF.12.240.85



Ø 1.2 mm

Double-ended Curette for Stapedectomy,  
Cups slightly angled forwards



Ø 1.8mm



Ø 1.2 mm

Double-ended curette for stapedectomy,  
Cups strongly angled forwards

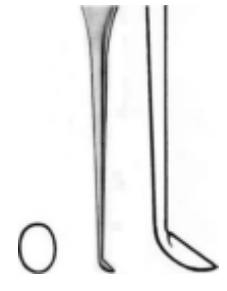

Ø 1.8 mm



# Otology Instruments



GUILFORD-WRIGHT  
NF.12.241.52

Curette for stapedectomy, cups slightly  
Angled forwards

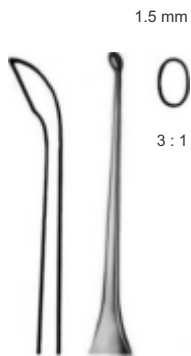

GUILFORD-WRIGHT  
NF.12.241.55

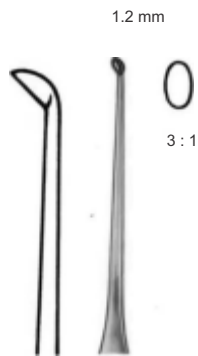

GUILFORD-WRIGHT  
NF.12.241.62

Curette for stapedectomy, cups strongly  
Angled forwards

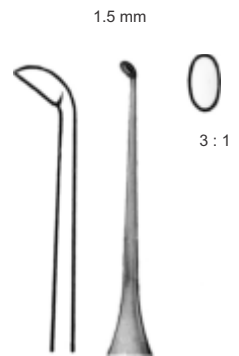

GUILFORD-WRIGHT  
NF.12.241.65



# Otology Instruments

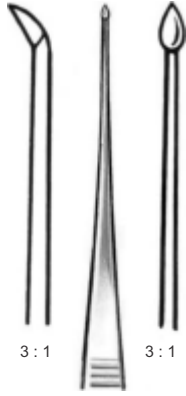

NF.12.242.90  
17 cm/ 6¾"

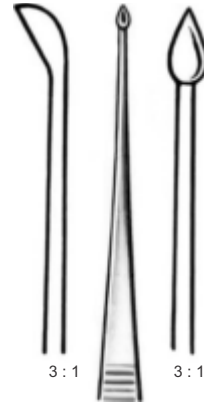

NF.12.242.92  
17 cm/ 6¾"



Double-ended curette for  
Stapedectomy, pointed, small

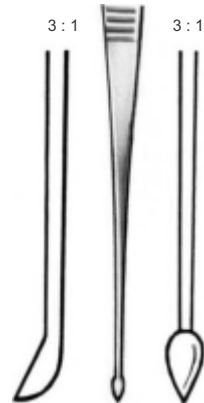

Double-ended curette for  
Stapedectomy, pointed, large

# Otology Instruments



## McIntosh Set, with Fiber Optic illumination With Interchangeable, Fiberoptic Channels

- NF.12.42.00 Set of 3 blades No. 2,3,4
- NF.12.42.02 Set of 5 blades No. 00,0,1,2,3 (pediatric)
- NF.12.42.03 Set of 4 blades No. 0,1,2,3 (pediatric)
- NF.12.43.04 Set of 4 blades No. 1,2,3,4
- NF.12.43.05 Set of 5 blades No. 0,1,2,3,4

All sets include 1 standard F.O. battery handle.  
Spare lamps can be ordered separately.

Supplied in hard plastic case.



## McIntosh Set, with Standard illumination

- NF.12.22.00 Set of 3 blades No. 2,3,4
- NF.12.22.02 Set of 5 blades No. 00, 0,1,2,3 (pediatric)
- NF.12.22.03 Set of 4 blades No. 0,1,2,3 (pediatric)
- NF.12.23.04 Set of 4 blades No. 1,2,3,4
- NF.12.23.05 Set of 5 blades No. 0,1,2,3,4
- NF.12.23.06 Set of 5 blades No. 1,2,3,4,5

All sets include 1 standard battery handle.  
Spare lamps can be ordered separately.

Supplied in hard plastic case.



## McIntosh Set, with Standard illumination Economy Model

- NF.12.22.50 Set of 3 blades No. 2,3,4
- NF.12.23.64 Set of 4 blades No. 1,2,3,4

All sets include 1 standard battery handle.  
Spare lamps can be ordered separately.

Supplied in hard, round artificial leather bag with  
pockets to hold blades.



## McIntosh Set, with Fiber Optic illumination With Integrated, Fiberoptic Channel

- NF.12.42.20 Set of 3 blades No. 2,3,4
- NF.12.42.23 Set of 4 blades No. 0,1,2,3 (pediatric)
- NF.12.43.24 Set of 4 blades No. 1,2,3,4
- NF.12.43.25 Set of 5 blades No. 0,1,2,3,4

All sets include 1 standard F.O. battery handle.  
Spare lamps can be ordered separately.

Supplied in hard plastic case.



## McIntosh Set, with Fiber Optic illumination With Intechangeable, Fiberoptic Channel

Set with new type of battery handle with double barrell  
(inside) for better autoclaving & safety to the bulb.

- NF.12.42.50 Set of 3 blades No. 2,3,4
- NF.12.43.94 Set of 4 blades No. 1,2,3,4

All sets include 1 standard F.O. battery handle.  
Spare lamps can be ordered separately.

Supplied in hard plastic case.





## Miller Set, with Standard Illumination

- NF.12.28.00 Set of 3 blades No. 1,2,3
- NF.12.28.03 Set of 5 blades No. 00,0,1,2,3 (pediatric)
- NF.12.28.04 Set of 4 blades No. 0,1,2,3 (pediatric)
- NF.12.28.05 Set of 4 blades No. 1,2,3,4
- NF.12.28.06 Set of 5 blades No. 0,1,2,3,4

All sets include 1 standard battery handle.  
Spare lamps can be ordered separately.

Supplied in hard plastic case.



## Miller Set, with Fiber Optic Illumination With Interchangeable, Fiberoptic Channels

- NF.12.48.00 Set of 3 blades No. 1,2,3
- NF.12.48.03 Set of 5 blades No. 00,0,1,2,3 (pediatric)
- NF.12.48.04 Set of 4 blades No. 0,1,2,3 (pediatric)
- NF.12.48.05 Set of 4 blades No. 1,2,3,4
- NF.12.48.06 Set of 5 blades No. 1,2,3,4,5

All sets include 1 F.O. battery handle.  
Spare lamps can be ordered separately.

Supplied in hard plastic case.



# Otology Instruments

## Wis-Foregger Set, with Standard Illumination

- NF.12.26.00 Set of 3 blades No. 2,3,4
- NF.12.26.03 Set of 5 blades No. 00,0,1,2,3 (pediatric)
- NF.12.26.04 Set of 4 blades No. 0,1,2,3 (pediatric)
- NF.12.26.05 Set of 4 blades No. 1,2,3,4
- NF.12.26.06 Set of 5 blades No. 0,1,2,3,4

All sets include 1 standard battery handle.  
Spare lamps can be ordered separately.

Supplied in hard plastic case.



## Wis-Foregger Set, with Fiber Optic Illumination With Interchangeable, Fiberoptic Channels

- NF.12.46.00 Set of 3 blades No. 2,3,4
- NF.12.46.04 Set of 4 blades No. 0,1,2,3 (pediatric)
- Set of 4 blades No. 1,2,3,4
- NF.12.46.06 Set of 5 blades No. 0,1,2,3,4

All sets include 1 F.O. battery handle.  
Spare lamps can be ordered separately.

Supplied in hard plastic case.



## Wis-Foregger Set, with Fiber Optic Illumination With Interchangeable, Fiberoptic Channels

Set with new type of Battery handle with double  
barrell (inside) for better autoclaving and safety to  
the bulb.

- NF.12.46.90 Set of 3 blades No. 2,3,4
- NF.12.46.94 Set of 4 blades No. 1,2,3,4

Supplied in hard plastic case.



# Otology Instruments

## McIntosh Blades, with Standard Illumination

Item No	Fig	Size	For
NF.12.24.09	00	45 mm	Premature babies
NF.12.24.10	0	55 mm	Premature babies
NF.12.24.11	1	70 mm	Infants
NF.12.24.12	2	90 mm	Children
NF.12.24.13	3	110 mm	Adults, Medium
NF.12.24.14	4	130 mm	Adults, Large
NF.12.24.15	5	155 mm	Adults, Extra Large

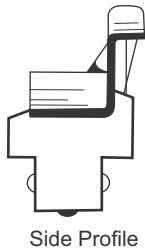

Side Profile

- Smooth Shape
- Bright Light
- Secure connections
- Matt Finish
- Standard Specifications



NF.12.24.11



NF.12.24.12



NF.12.24.13



NF.12.24.14



NF.12.24.15



NF.12.24.09



NF.12.24.10

# Otology Instruments

McIntosh Blades, with Fiber Optic Illumination  
Interchangeable Fiber Optic Channels.

Item No	Fig	Size	For
NF.12.44.09	00	45 mm	Premature babies
NF.12.44.10	0	55 mm	Premature babies
NF.12.44.11	1	70 mm	Infants
NF.12.44.12	2	90 mm	Children
NF.12.44.13	3	110 mm	Adults, Medium
NF.12.44.14	4	130 mm	Adults, Large
NF.12.44.15	5	155 mm	Adults, Extra Large

Fiberoptic channels can be taken apart by simple unscrewing. They can be ordered separately.

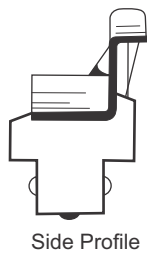
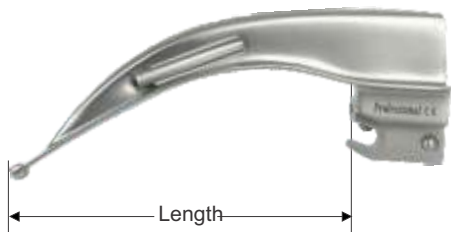

- Replaceable F.O. Channels
- Big Fiber Optic bundle.
- Both ends well protected
- Smooth Shape
- Bright Light
- Secure connections
- Matt Finish
- Standard Specifications



# Otology Instruments

McIntosh Blades, with Fiber Optic Illumination  
Integrated Fiber Optic Channels.

Item No	Fig	Size	For
NF.12.44.21	1	70 mm	Infants
NF.12.44.22	2	90 mm	Children
NF.12.44.23	3	110 mm	Adults, Medium
NF.12.44.24	4	130 mm	Adults, Large

Fiber Optic Channels are completely  
integrated into the body of blades.



NF.12.44.21



NF.12.44.23

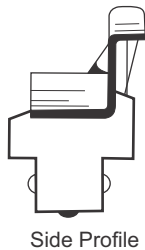

NF.12.44.23



NF.12.44.24

- Completely Sealed Design
- Big Fiber Optic bundle.
- Both ends well protected
- Smooth Shape
- Bright Light
- Secure connections
- Matt Finish
- Standard Specifications

# Otology Instruments

## Wis-Foregger Blades, with Standard Illumination

Item No	Fig	Size	For
NF.12.26.10	0	55 mm	Premature babies.
NF.12.26.11	1	70 mm	Infants
NF.12.26.12	2	90 mm	Children
NF.12.26.13	3	110 mm	Adults, Medium
NF.12.26.14	4	135 mm	Adults, Large



- Smooth Shape
- Bright Light
- Secure connections
- Matt Finish
- Standard Specifications



## Wis-Foregger Blades, with Fiber Optic Illumination Interchangeable, Fiber Optic Channel

Item No	Fig	Size	For
NF.13.46.09	00	45 mm	Premature babies
NF.13.46.10	0	55 mm	Premature babies
NF.13.46.11	1	70 mm	Infants
NF.13.46.12	2	90 mm	Children
NF.13.46.13	3	110 mm	Adults, Medium
NF.13.46.14	4	135 mm	Adults, Large

Fiberoptic channels can be taken apart by simple unscrewing. They can be ordered separately.

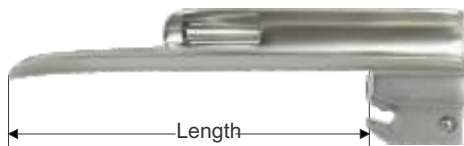

NF.13.46.09



NF.13.46.10



NF.13.46.11



NF.13.46.12



NF.13.46.13



NF.13.46.14

- Replaceable F.O. Channels
- Big Fiber Optic bundle.
- Both ends well protected
- Smooth Shape
- Bright Light
- Secure connections
- Matt Finish
- Standard Specifications

# Otology Instruments

## Miller Blades, with Standard Illumination

Item No	Fig	Size	For
NF.13.28.29	00	45 mm	Premature babies.
NF.13.28.30	0	55 mm	Infants
NF.13.28.31	1	80 mm	Children
NF.13.28.32	2	130 mm	Adults, Medium
NF.13.28.33	3	170 mm	Adults, Lage
NF.13.28.34	4	180 mm	Adults, Extra Large



NF.13.28.29



NF.13.28.30



NF.13.28.31



Side Profile



NF.13.28.32

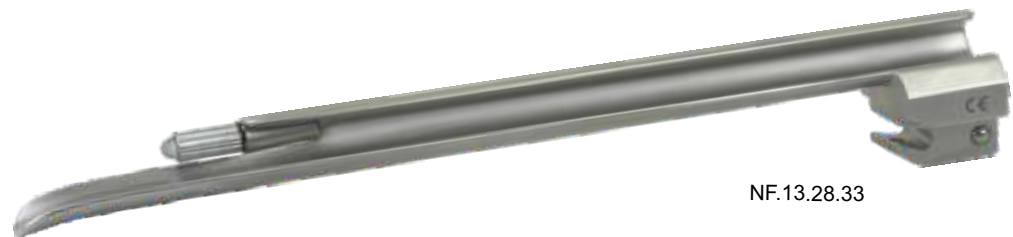

NF.13.28.33



NF.13.28.34

- Smooth Shape
- Bright Light
- Secure connections
- Matt Finish
- Standard Specifications



# Otology Instruments

Miller Blades, with Fiber Optic Illumination  
Interchangeable, Fiber Optic Channel

Item No	Fig	Size	For
NF.13.48.29	00	45 mm	Premature babies.
NF.13.48.30	0	55 mm	Infants
NF.13.48.31	1	80 mm	Children
NF.13.48.32	2	130 mm	Adults, Medium
NF.13.48.33	3	170 mm	Adults, Large
NF.13.48.34	4	180 mm	Adults, Extra Large

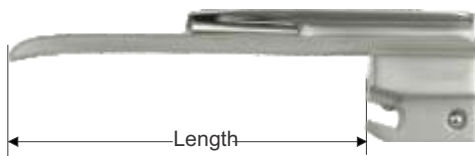

NF.13.48.29



NF.13.48.30



NF.13.48.31



NF.13.48.32



NF.13.48.33



NF.13.48.34

- Replaceable F.O. Channels
- Big Fiber Optic bundle.
- Both ends well protected
- Smooth Shape
- Bright Light
- Secure connections
- Matt Finish
- Standard Specifications

# Otology Instruments

## McIntosh Blades, with Standard Illumination, **Economy Model**

Item No	Fig	Size	For
NF.13.25.11	1	70 mm	Infants
NF.13.25.12	2	90 mm	Children
NF.13.25.13	3	110 mm	Adults, Medium
NF.13.25.14	4	130 mm	Adults, Large



NF.13.25.11



Length



NF.13.25.12

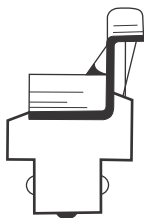

Side Profile



NF.13.25.13



NF.13.25.14

- Smooth Shape
- Bright Light
- Secure connections
- Matt Finish
- Standard Specifications

## Miller Blades, with Standard Illumination, **Economy Model**

Item No	Fig	Size	For
NF.13.29.31	1	80 mm	Children
NF.13.29.32	2	130 mm	Adults, Medium
NF.13.29.33	3	170 mm	Adults, Large
NF.13.29.34	4	180 mm	Adults, Extra Large



NF.13.29.31



NF.13.29.32

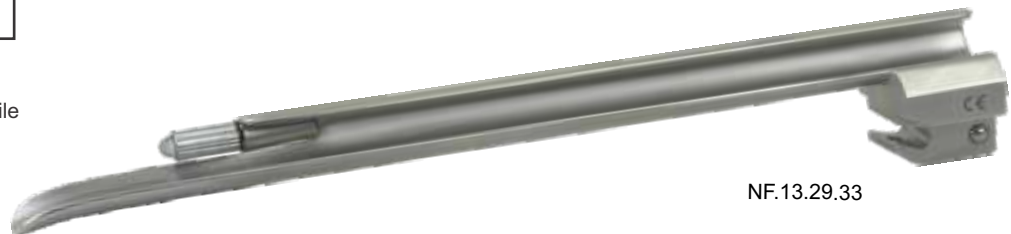

NF.13.29.33

- Smooth Shape
- Bright Light
- Secure connections
- Matt Finish
- Standard Specifications



NF.13.29.34

## Nawrooz TeleTip Laryngoscope For Difficult Intubation

Item No	Fig	Size	For
NF.13.49.62	2	100 mm	Infants
NF.13.49.63	3	130 mm	Children
NF.13.49.64	4	155 mm	Adults, Medium



Nawrooz TeleTip is a MacIntosh Laryngoscope blade with an adjustable distal tip, which is controlled by a lever to lift epiglottis during intubation.

It gives a clear view of vocal chords. Un-necessary pressure on tongue and contact with upper teeth is thus avoided.

- Completely autoclavable
- High quality steel construction
- Supplied in hard or soft case.

Battery handles, Fiber Optic  
For blades with Fiberoptic Illumination

Item No	Dia	Size	For
NF.13.30.40	24mm	11cm	
NF.13.31.20	19mm	13cm	Children
NF.13.32.62	28mm	14cm	Adults



NF.13.30.40



NF.13.32.62



NF.13.31.20

Battery Handles, Fiber Optic  
Double Barrel (inside) for better  
cleaning and safety to lamp

Item No	Dia	Size	For
NF.13.35.50	28 mm	14 cm	



NF.13.35.50

# Otology Instruments

## Battery Handles, with Standard Illumination

Item No	Dia	Size	For
NF.13.30.10	24mm	11cm	Children
NF.13.31.11	19mm	13cm	Pediatric intubation
NF.13.32.12	28mm	14cm	Adults.
NF.13.32.20	28mm	14cm	Adults. (Economy)



NF.13.30.10

NF.13.31.11

NF.13.32.12

NF.13.32.20

# Otology Instruments



COLLIN  
NF.13.16.16  
16 cm / 6¼"

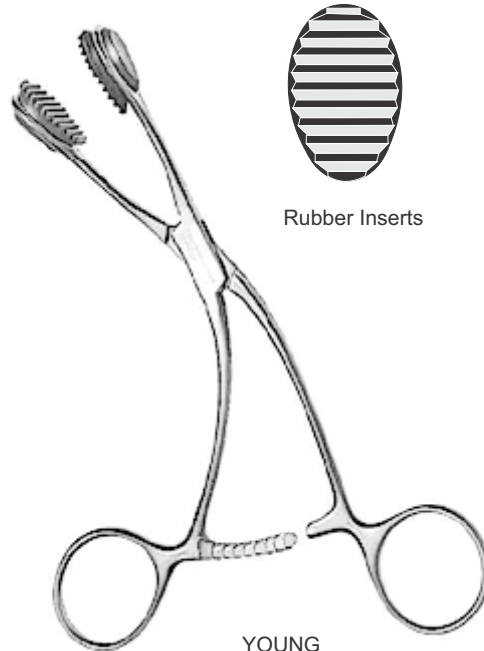

Rubber Inserts

YOUNG  
NF.13.17.16  
16 cm / 6¼"



NF.13.05.16  
16 cm / 6¼"  
Fig # 1



NF.13.05.19  
19 cm / 7½"  
Fig # 2

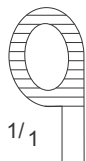

1/1  
NF.13.05.24  
24 cm / 9½"  
Fig # 3



MAGILL

# Otology Instruments

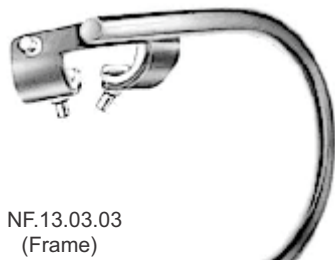

NF.13.03.03  
(Frame)



DAVIS BOYLE  
NF.13.02.02  
Complete  
(1 Frame, 5 Tongue Depressors)



NF.13.01.01  
20 x 25 mm  
# 1

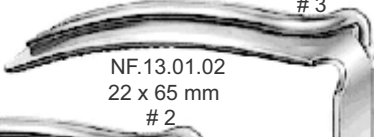

NF.13.01.02  
22 x 65 mm  
# 2

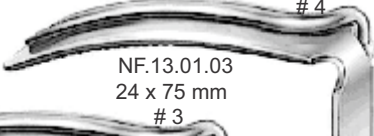

NF.13.01.03  
24 x 75 mm  
# 3

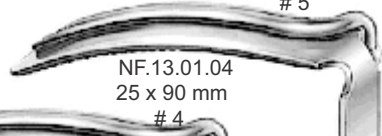

NF.13.01.04  
25 x 90 mm  
# 4



NF.13.01.05  
26 x 110 mm  
# 5

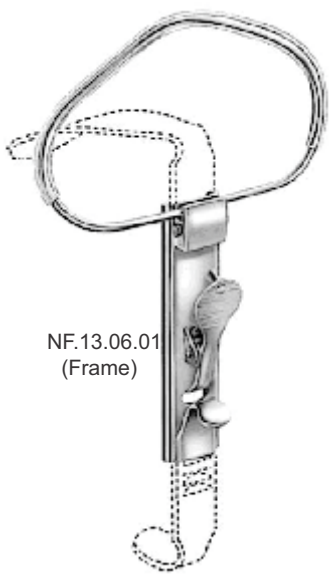

NF.13.06.01  
(Frame)

MCIVOR  
NF.13.07.00  
Complete  
(1 Frame, 3 Tongue Depressors)

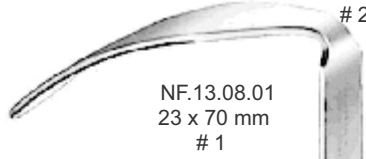

NF.13.08.01  
23 x 70 mm  
# 1

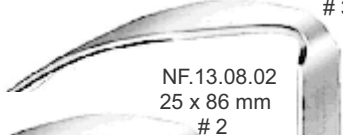

NF.13.08.02  
25 x 86 mm  
# 2

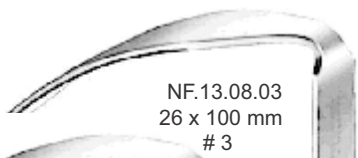

NF.13.08.03  
26 x 100 mm  
# 3



# Dermatology



Fing Ring Cutters, Comedo Extractors

NF.13.03.01  
Spare Saw  
Blade Only



NF.13.03.00  
16 cm / 6 1/4"

NF.13.05.01  
Spare Saw  
Blade Only



NF.13.04.00  
16 cm / 6 1/4"

SAALFELD  
NF.13.06.11  
11 cm / 4 1/2"



SAALFELD  
NF.13.07.85  
15 cm / 6"



UNNA  
NF.13.08.14  
14 cm / 5 1/2"



UNNA  
NF.13.09.14  
14 cm / 5 1/2"



UNNA  
NF.13.08.31 – NF.13.08.42

Hole ø 1 mm  
NF.13.08.31  
  
Hole ø 1.5 mm  
NF.13.08.34  
  
Hole ø 2 mm  
NF.13.08.42



UNNA VIDAL  
NF.13.10.52

## Skin punches, Hooklets, Curettes, Nail Pulling Forceps

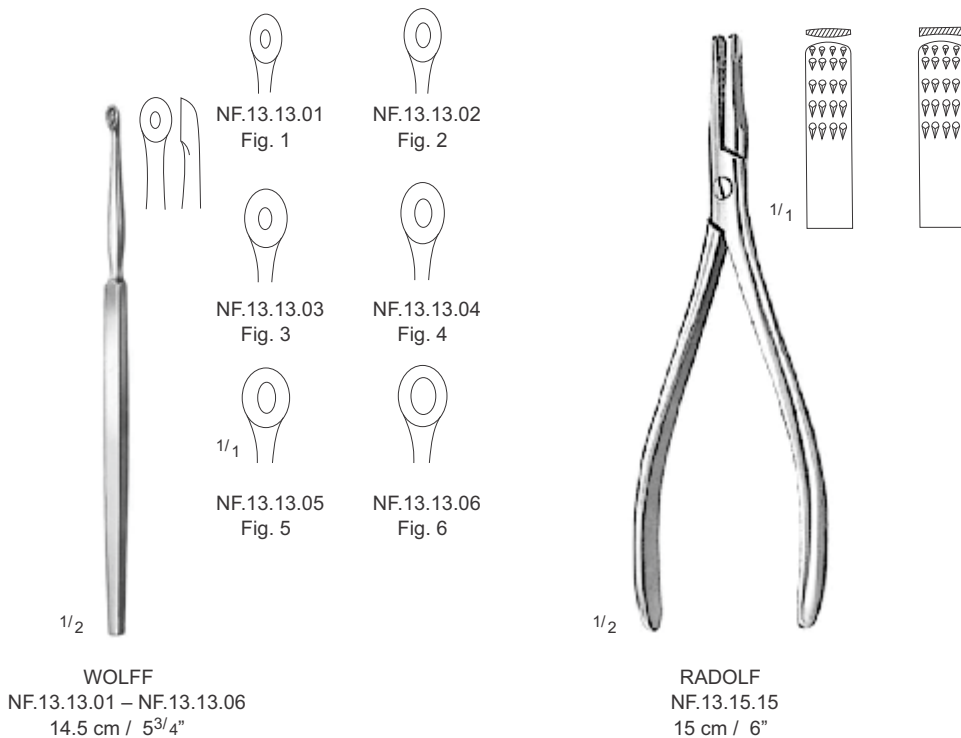
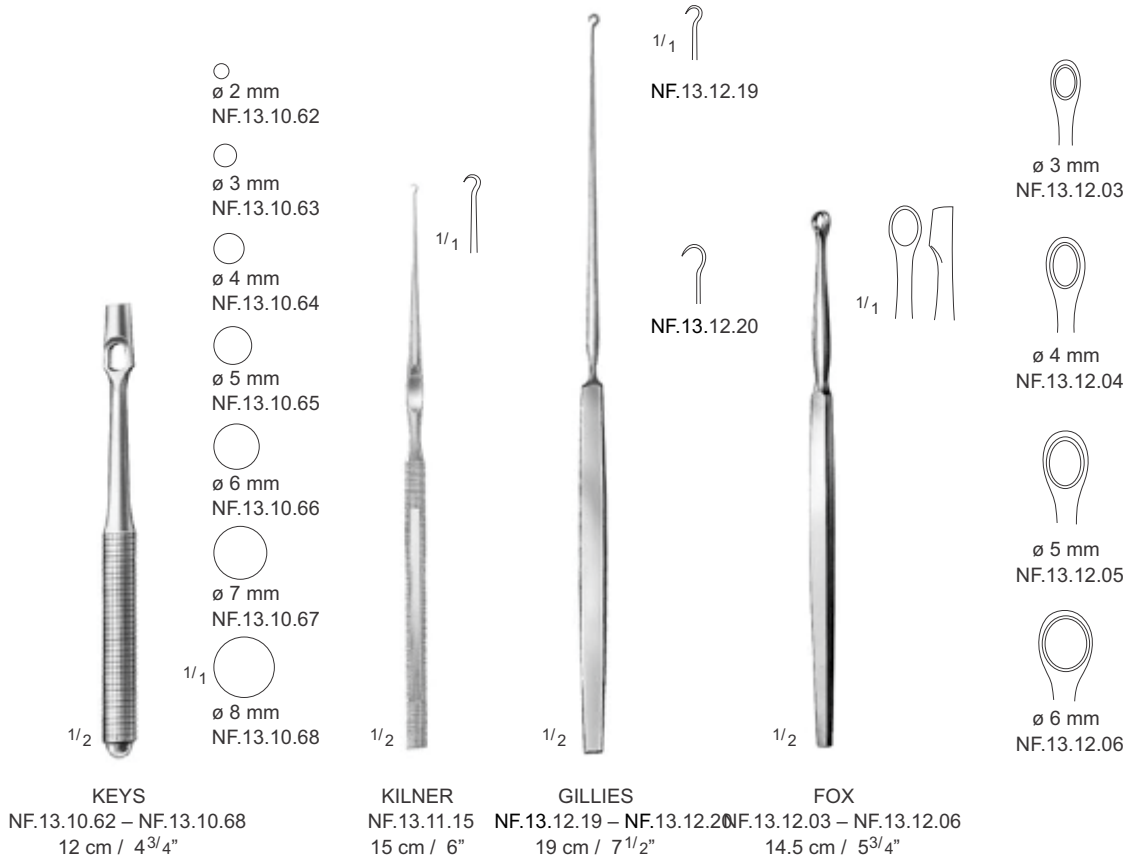

# Holloware Instruments



Holloware Instruments

# Holloware Instruments



Horizontal  
Ventilation

### SCHIMMELBUSCH

	∅	h
NF.13.25.1414	x 14	cm
NF.13.25.1616	x 15	cm
NF.13.25.1919	x 16	cm
NF.13.25.2019	x 19	cm
NF.13.25.2424	x 12	cm
NF.13.25.2524	x 16	cm
NF.13.25.2724	x 24	cm
NF.13.25.2929	x 16	cm
NF.13.25.3029	x 24	cm
NF.13.25.3434	x 16	cm
NF.13.25.3534	x 24	cm
NF.13.25.3939	x 14	cm
NF.13.25.4039	x 19	cm
NF.13.25.4139	x 29	cm



Vertical  
Ventilation

### KONRICH

	∅	h
NF.13.26.1414	x 14	cm
NF.13.26.1616	x 15	cm
NF.13.26.1919	x 16	cm
NF.13.26.2019	x 19	cm
NF.13.26.2424	x 12	cm
NF.13.26.2524	x 16	cm
NF.13.26.2724	x 24	cm
NF.13.26.2929	x 16	cm
NF.13.26.3029	x 24	cm
NF.13.26.3434	x 16	cm
NF.13.26.3534	x 24	cm
NF.13.26.3939	x 14	cm
NF.13.26.4039	x 19	cm
NF.13.26.4139	x 29	cm



Cather and Instruments Trays (with strap handle)

	L	W	D
NF.13.01.38	217	x 80	x 38 mm
NF.13.01.50	360	x 80	x 50 mm
NF.13.01.51	445	x 120	x 50 mm



with flat cover

	L	W	D
NF.13.02.50	313	x 203	x 50 mm

# Holloware Instruments



Without cover

	L	W	D
NF.13.03.50	227	130	50 mm
NF.13.03.51	306	194	50 mm

	L	W	D
NF.13.04.15	150	100	25 mm
NF.13.04.20	200	150	38 mm
NF.13.04.25	250	200	50 mm
NF.13.04.30	300	250	50 mm
NF.13.04.35	355	305	50 mm
NF.13.04.40	405	305	50 mm
NF.13.04.45	455	355	50 mm



	L	W	D
NF.13.05.21	210	160	10 mm
NF.13.05.24	240	180	10 mm
NF.13.05.31	310	150	10 mm
NF.13.05.32	310	210	10 mm
NF.13.05.35	350	240	10 mm
NF.13.05.40	400	270	10 mm
NF.13.05.42	420	280	10 mm



NF.13.05.82  
ø 200 x 70 mm



NF.13.05.63  
235 x 190 x 40 mm

L = Length    W = Width    D = Depth    ø = Diameter

# Holloware Instruments



	∅	x	Height
NF.13.08.07	75	x	60 mm
NF.13.08.08	75	x	75 mm
NF.13.08.10	100	x	60 mm
NF.13.08.11	100	x	100 mm
NF.13.08.12	125	x	80 mm
NF.13.08.13	125	x	125 mm
NF.13.08.15	150	x	150 mm

## KIDNEY BOWL (With Cover)

	Length	Width	Depth
NF.13.11.17	170	x 100	x 35 mm
NF.13.11.25	250	x 140	x 40 mm
NF.13.11.27	275	x 150	x 45 mm
NF.13.11.30	305	x 140	x 50 mm



	∅	x	D	Capacity
NF.13.12.07	165	x	60 mm	0.75 L
NF.13.12.10	175	x	70 mm	1.0 L
NF.13.12.20	220	x	80 mm	2.0 L
NF.13.12.25	225	x	90 mm	2.5 L
NF.13.12.30	240	x	110 mm	3.0 L
NF.13.12.45	275	x	115 mm	4.5 L
NF.13.12.60	290	x	125 mm	6.0 L
NF.13.12.61	310	x	120 mm	6.0 L
NF.13.12.85	345	x	125 mm	8.5 L
NF.13.12.91	380	x	125 mm	11 L



	L	W	D
NF.13.10.17	170	x 100	x 35 mm
NF.13.10.20	200	x 120	x 35 mm
NF.13.10.25	250	x 140	x 40 mm
NF.13.10.27	275	x 150	x 45 mm
NF.13.10.30	305	x 140	x 50 mm

# Holloware Instruments



	∅	x	D	Capacity
NF.13.13.16	167	x	62 mm	0.9 L
NF.13.13.20	200	x	75 mm	1.4 L
NF.13.13.23	230	x	82 mm	2.2 L
NF.13.13.26	261	x	94 mm	3.0 L
NF.13.13.29	292	x	103 mm	4.0 L
NF.13.13.32	328	x	111 mm	5.7 L

Sponge Bowls  
(Straight Sided Wall)

	Diameter	Depth	Capacity
NF.13.14.04	108 x 50 mm	0.4 liter	
NF.13.14.06	132 x 58 mm	0.6 liter	
NF.13.14.09	149 x 67 mm	0.9 liter	
NF.13.14.13	169 x 74 mm	1.3 liter	
NF.13.14.18	188 x 75 mm	1.8 liter	



	∅	x	Height
NF.13.15.30	30	x	90 mm
NF.13.15.50	50	x	100 mm
NF.13.15.51	50	x	130 mm
NF.13.15.52	50	x	175 mm
NF.13.15.75	75	x	100 mm
NF.13.15.76	75	x	130 mm
NF.13.15.77	75	x	175 mm
NF.13.15.98	100	x	175 mm
NF.13.15.99	100	x	200 mm



**NEEDLE JAR**  
Diameter Height Capacity  
NF.13.16.80 80 x 63 mm 0.3 liter



**SPUTUM CUP**  
With Hinged lid and handle  
Height Diameter  
NF.13.20.80 90 x 80 mm

**APPLICATOR JAR WITH COVER**  
Height Depth  
NF.13.17.79 79 mm x 185 mm



# Holloware Instruments



NF.13.22.25  
25 cc



NF.13.22.50  
50 cc



NF.13.23.90  
ø 90 x 90 mm, height



NF.13.20.80  
ø 80 x 90 mm

## IODINE CUPS

	Diameter	Depth	Capacity
NF.13.18.52	52	x 34 mm	2 oz
NF.13.18.58	56	x 40 mm	3 oz
NF.13.18.64	64	x 44 mm	4 oz
NF.13.18.71	71	x 45 mm	6 oz
NF.13.18.83	83	x 55 mm	10 oz
NF.13.18.88	88	x 65 mm	14 oz



## WASH BASIN

	Diameter	Depth	Capacity
NF.13.19.80	312	x 80 mm	3.7 liter
NF.13.19.92	336	x 92 mm	4.7 liter



# Holloware Instruments

L = Length      W = Width      D = Depth

Style A



	L	W	D
NF.13.21.46	165 x	90 x	35 mm
NF.13.21.50	200 x	100 x	35 mm
NF.13.21.51	200 x	100 x	50 mm
NF.13.21.53	230 x	130 x	50 mm
NF.13.21.56	260 x	150 x	50 mm
NF.13.21.58	280 x	140 x	60 mm
NF.13.21.60	300 x	200 x	50 mm

Style B



	L	W	D
NF.13.23.46	165 x	90 x	35 mm
NF.13.23.50	200 x	100 x	35 mm
NF.13.23.51	200 x	100 x	50 mm
NF.13.23.53	230 x	130 x	50 mm
NF.13.23.55	280 x	140 x	60 mm
NF.13.23.56	260 x	150 x	50 mm
NF.13.23.60	300 x	200 x	50 mm

Style C



	L	W	D
NF.13.22.46	165 x	90 x	35 mm
NF.13.22.48	180 x	80 x	50 mm
NF.13.22.50	200 x	100 x	35 mm
NF.13.22.51	200 x	100 x	50 mm
NF.13.22.53	230 x	130 x	50 mm
NF.13.22.55	250 x	120 x	60 mm
NF.13.22.56	260 x	180 x	50 mm
NF.13.22.58	280 x	140 x	60 mm
NF.13.22.60	300 x	200 x	50 mm
NF.13.22.62	320 x	150 x	60 mm
NF.13.22.66	360 x	160 x	70 mm

# Holloware Instruments

	∅	x	D	Capacity
NF.13.24.10	108	x	131 mm	1.0 L
NF.13.24.19	125	x	188 mm	1.9 L



### Bed Pans

	L	W	H
NF.13.25.10	356 x	289 x	104 mm
NF.13.25.14	311 x	241 x	91 mm



### Fractured Bed Pans

	L	W	H	
NF.13.26.30	302 x	241 x	81 mm	without cover
NF.13.27.30	320 x	241 x	81 mm	with cover



### Urinals

	∅	L	C
NF.13.28.15	113 x	235 x	1.5 L Male Horizontal Type
NF.13.29.17	113 x	220 x	1.7 L Male. Upright Type



### Female Urinals

	L	W	H	Capacity
NF.13.30.11	220 x	115 x	148 mm	1.1 L



# Thoracic Instruments



# Thoracic Instruments



1/2  
GLUCK  
NF.13.02.19  
19 cm / 7½"



1/2  
NF.13.03.22  
22 cm / 8¾"

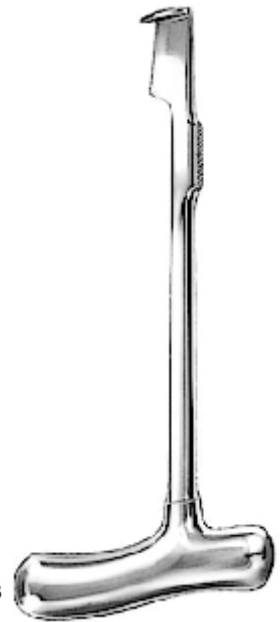

1/3  
LEBSCHE  
NF.13.19.90  
25 cm / 10"



NF.13.07.01  
For the Right Hand  
NF.13.07.02  
For the Left Hand

1/3  
BRUNNER  
NF.13.07.01 – NF.13.07.02  
32 cm / 12½"



1/3  
GIERTZ  
NF.13.14.25  
25 cm / 10"

# Thoracic Instruments

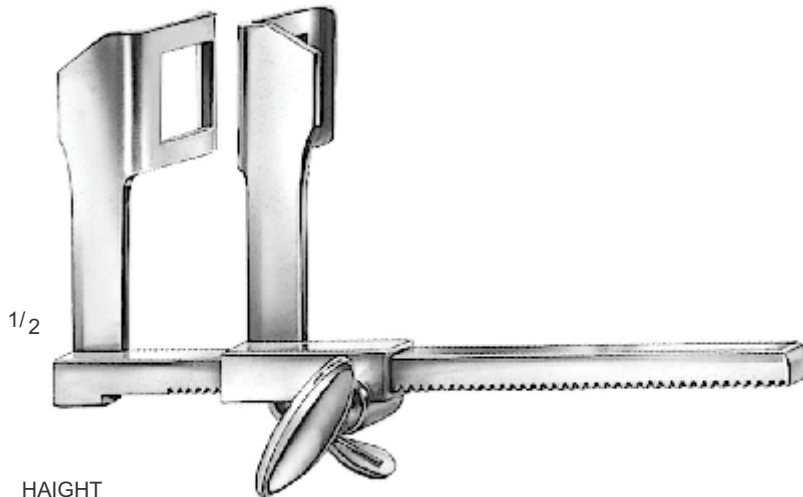

HAIGHT

	a	b	c
NF.13.23.20	30 mm	30 mm	90 mm / 3½"

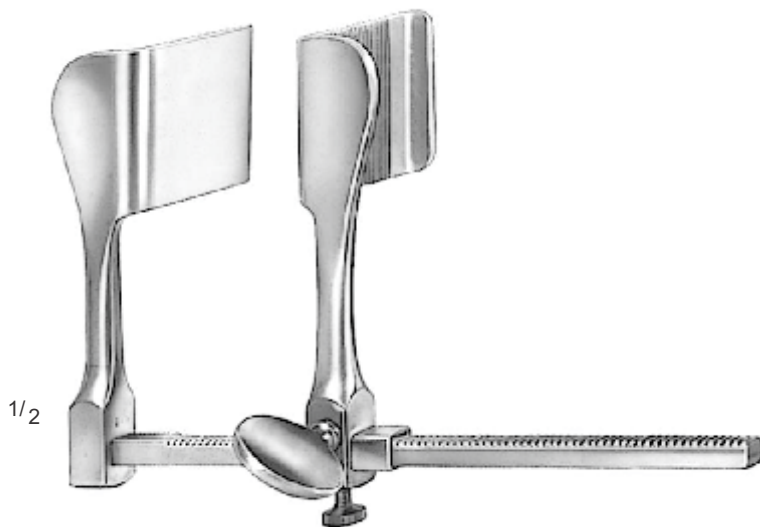
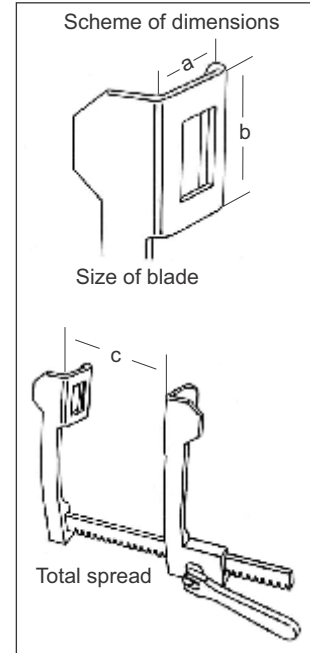

TUFFIER

	a	b	c
NF.13.22.41	45 mm	45 mm	160 mm / 6¼"

# Thoracic Instruments

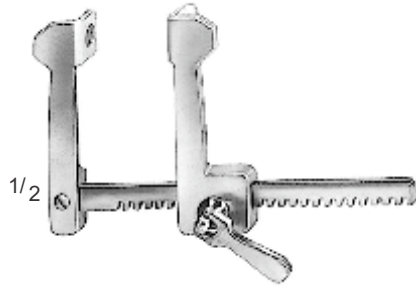

FINOCHIETTO-BABY

	a	b	c
NF.13.21.61	15 mm	15 mm	75 mm / 2"

Scheme of dimensions

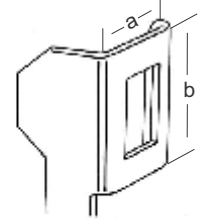

Size of blade

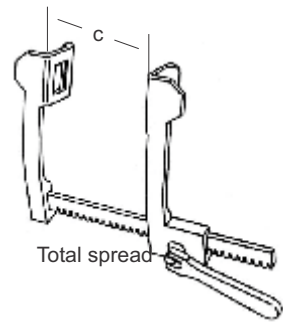

Total spread

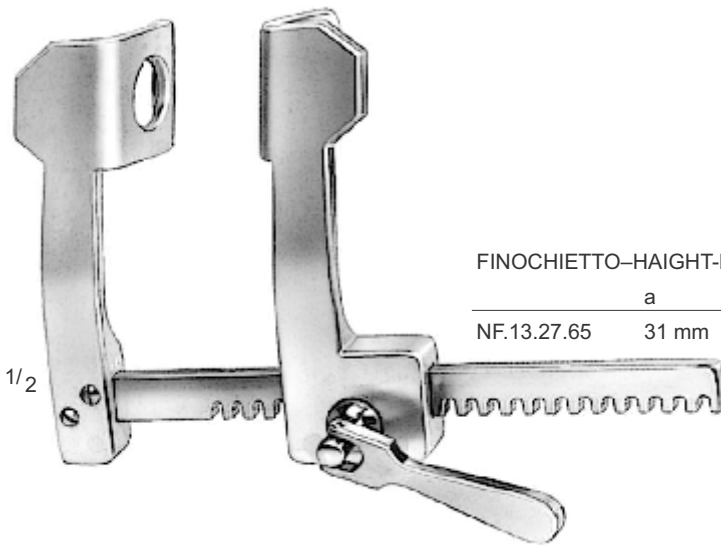

FINOCHIETTO-HAIGHT-BABY

	a	b	c
NF.13.27.65	31 mm	31 mm	100 mm / 4"

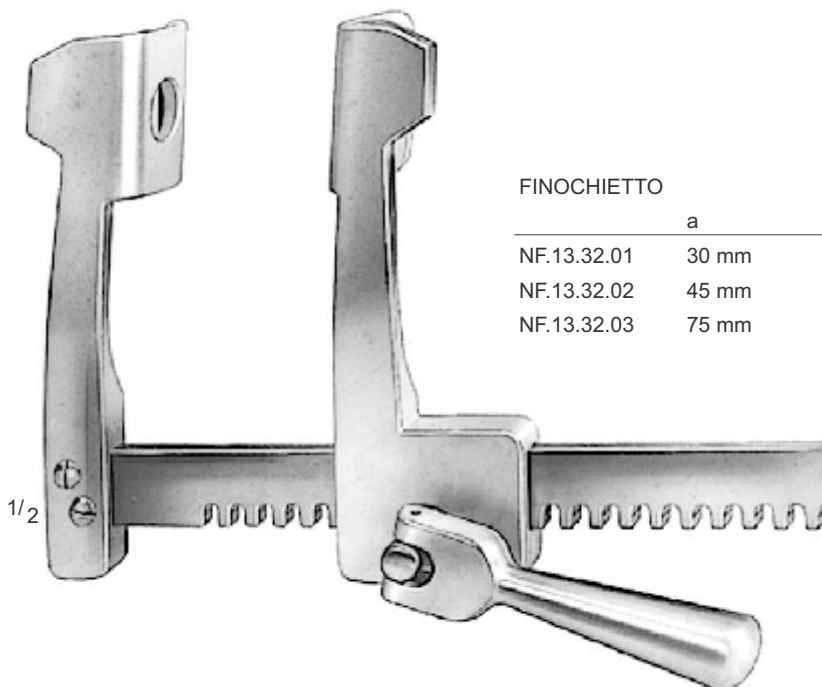

FINOCHIETTO

	a	b	c
NF.13.32.01	30 mm	40 mm	150 mm / 6"
NF.13.32.02	45 mm	65 mm	200 mm / 8"
NF.13.32.03	75 mm	65 mm	250 mm / 10"

# Thoracic Instruments



BURFORD-FINOCHIETTO  
with 2 pairs of blades

	a	b	c
NF.13.33.53	65 mm 47 mm	62 mm 62 mm	200 mm / 8"
NF.13.33.54	65 mm 47 mm	62 mm 62 mm	250 mm / 10"
NF.13.33.55	65 mm 47 mm	62 mm 62 mm	300 mm / 12"

1/2

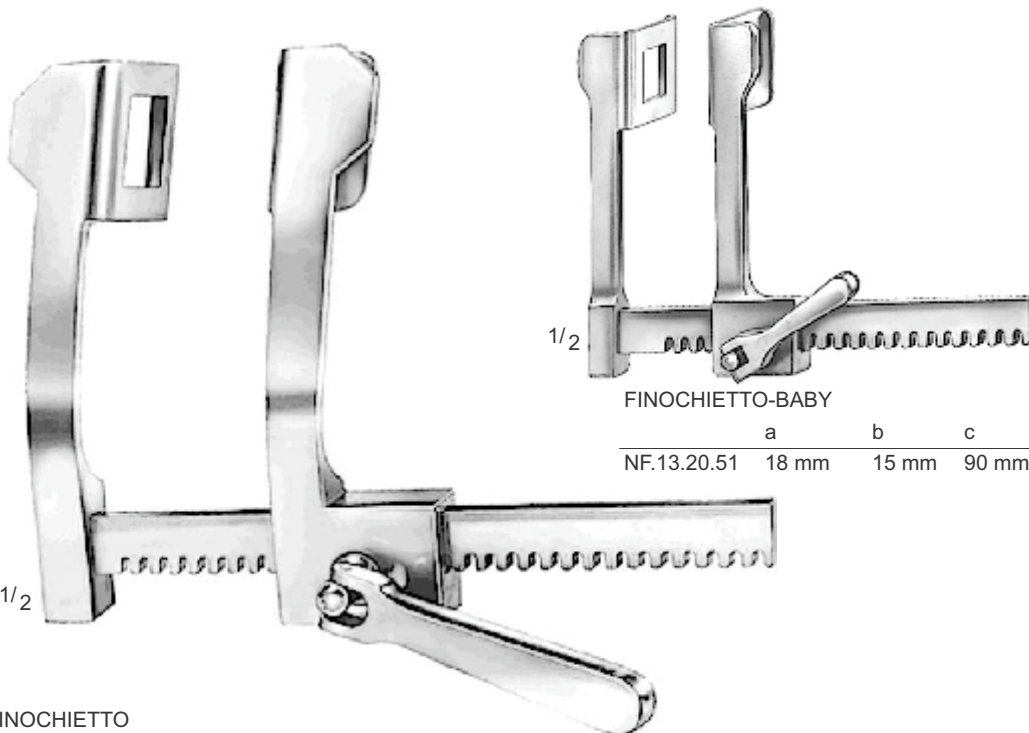

FINOCHIETTO-BABY

	a	b	c
NF.13.20.51	18 mm	15 mm	90 mm / 3½"

1/2

FINOCHIETTO

	a	b	c
NF.13.34.01	30 mm	45 mm	150 mm / 6"
NF.13.34.02	46 mm	62 mm	190 mm / 7½"
NF.13.34.03	80 mm	65 mm	190 mm / 7½"

L = Length    W = Width    D = Depth    ø = Diameter



# Thoracic Instruments

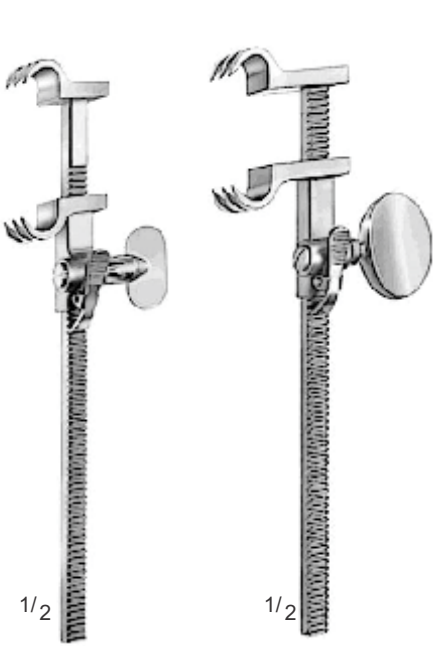

**BAILEY**  
NF.13.36.40  
16 cm / 6¼"

**BAILEY-GIBBON**  
NF.13.37.50  
16 cm / 6¼"



**DOYEN**  
NF.13.45.01 NF.13.46.12  
17 cm / 6¾"

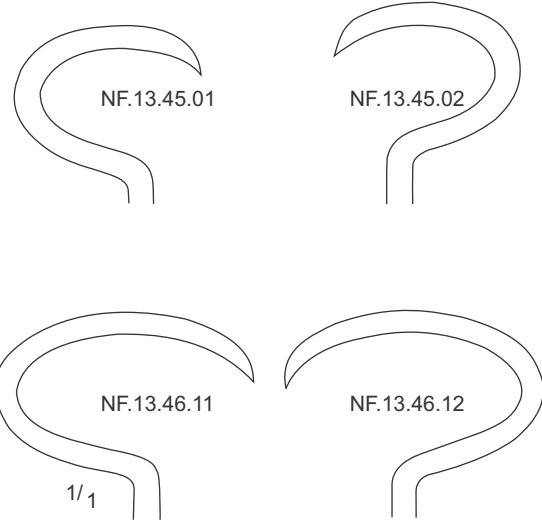

**ALLISON**  
NF.13.50.05  
27 cm / 10¼"

NF.13.50.10  
32 cm / 12½"

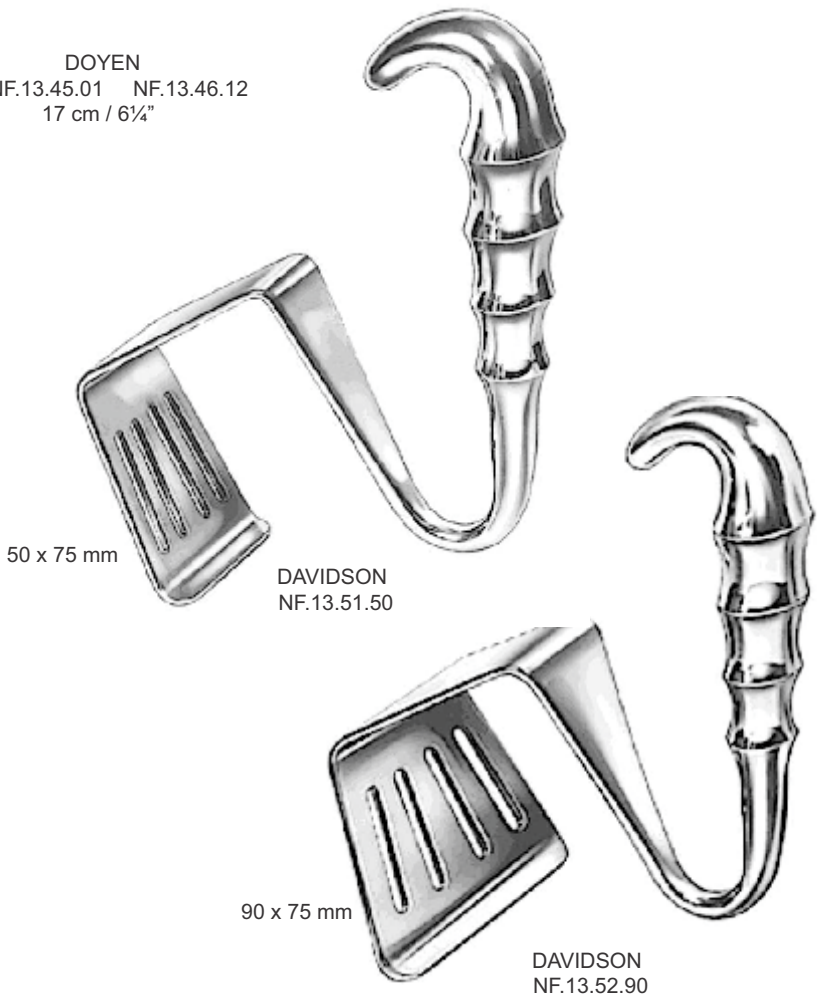

# Thoracic Instruments

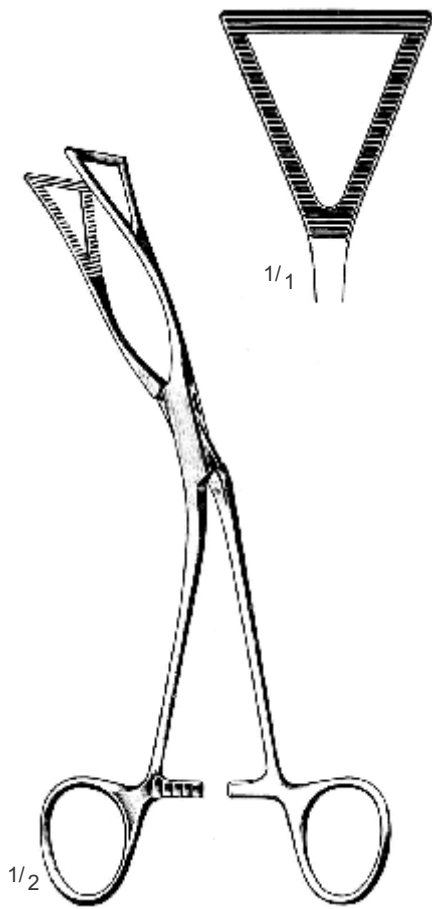

LOVELACE  
NF.13.56.19  
19 cm / 7½"

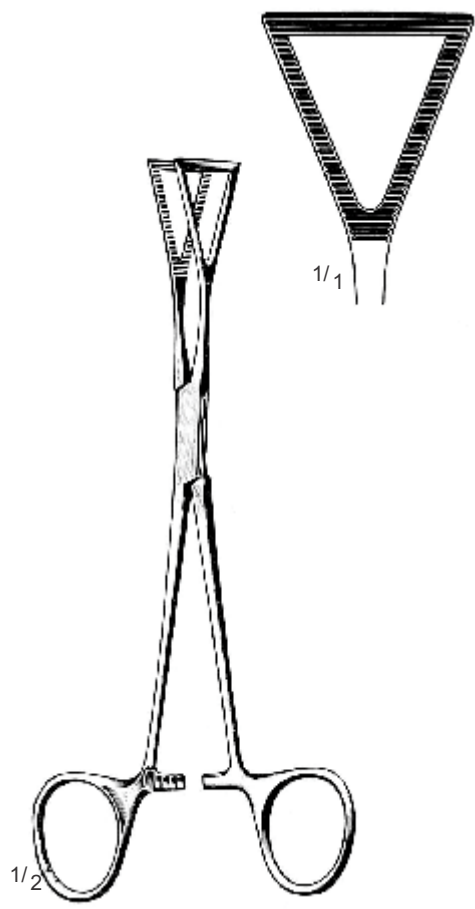

LOVELACE  
NF.13.56.39  
19 cm / 7½"

# Thoracic Instruments

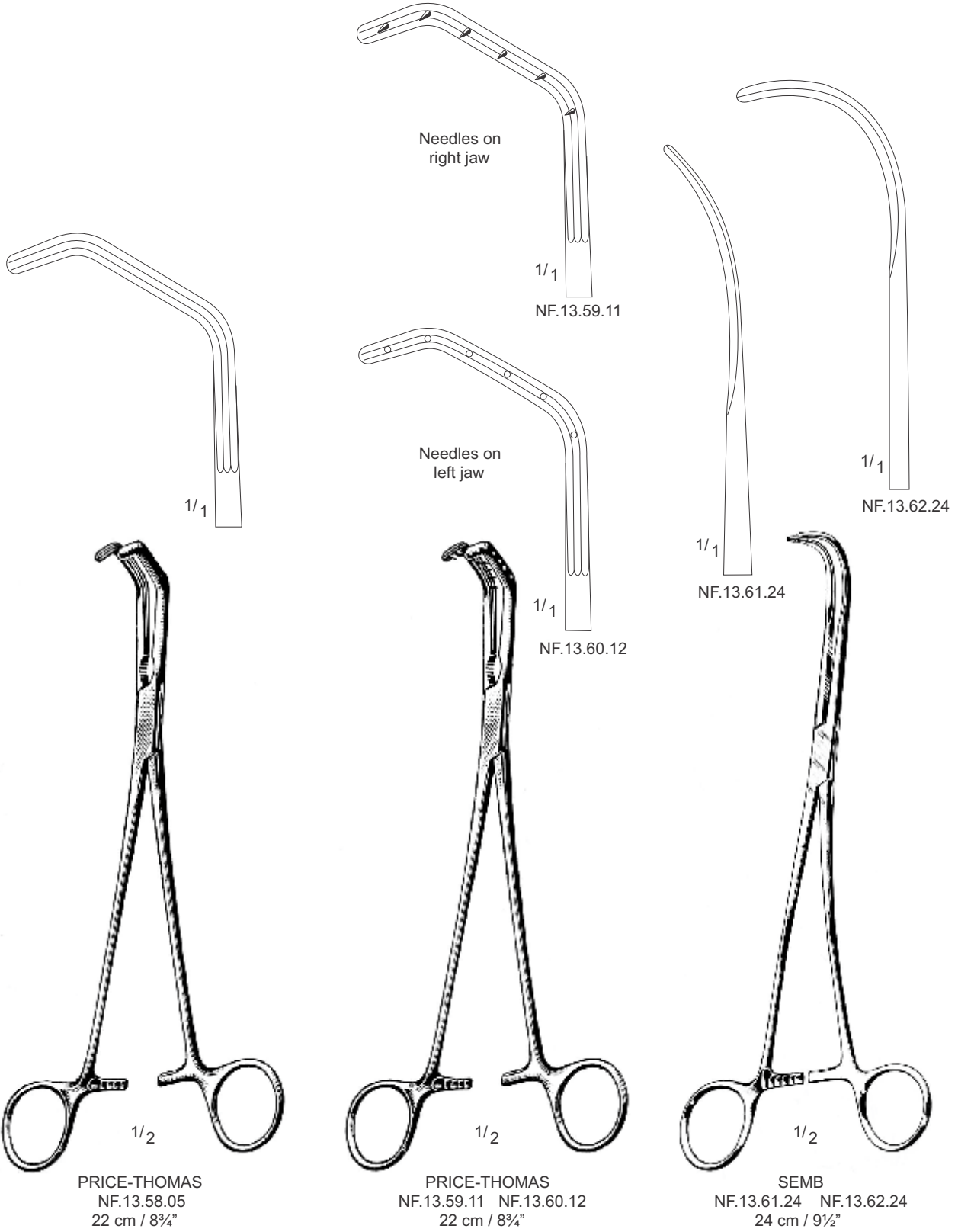

PRICE-THOMAS  
NF.13.58.05  
22 cm / 8¾"

PRICE-THOMAS  
NF.13.59.11 NF.13.60.12  
22 cm / 8¾"

SEMB  
NF.13.61.24 NF.13.62.24  
24 cm / 9½"



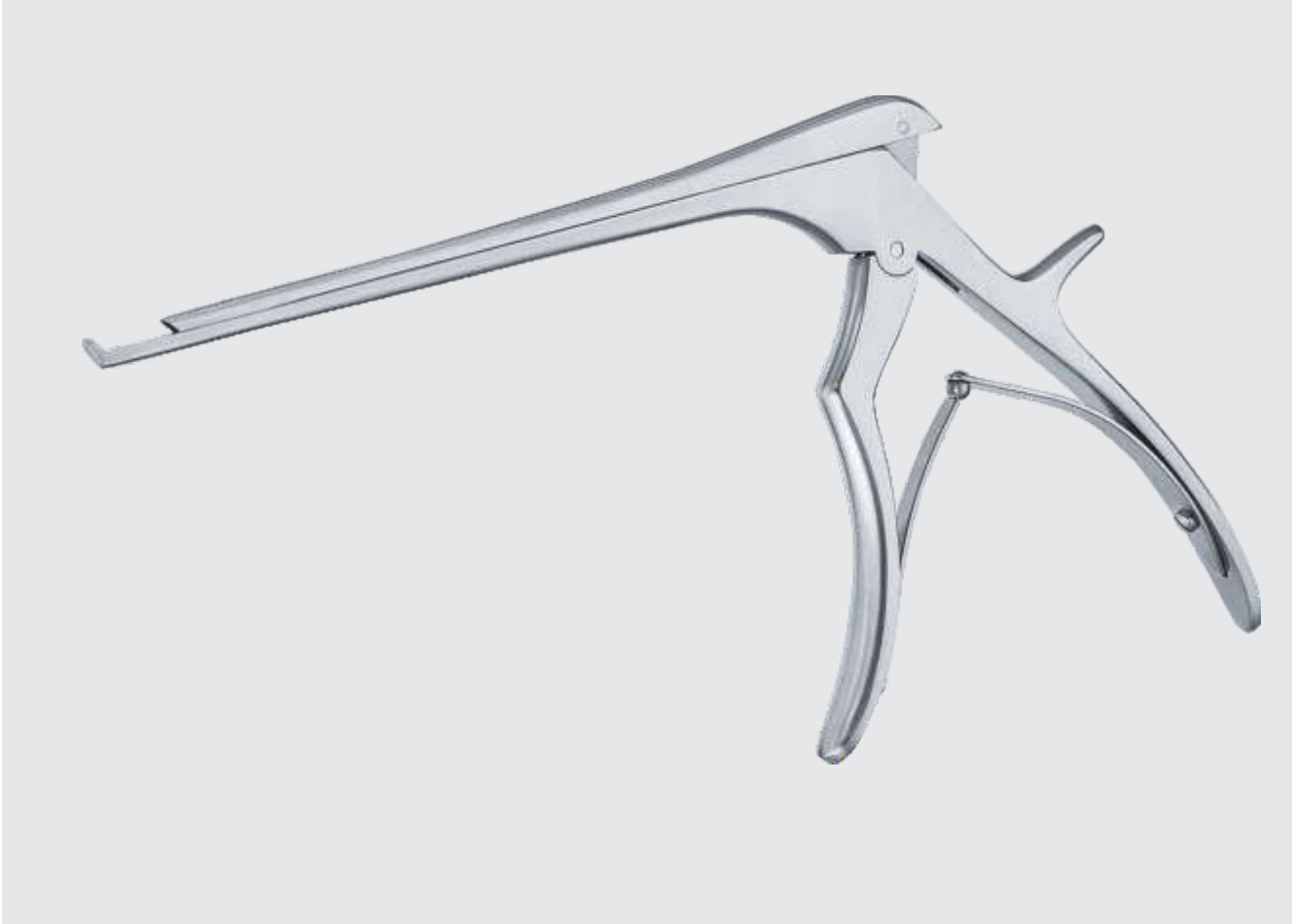

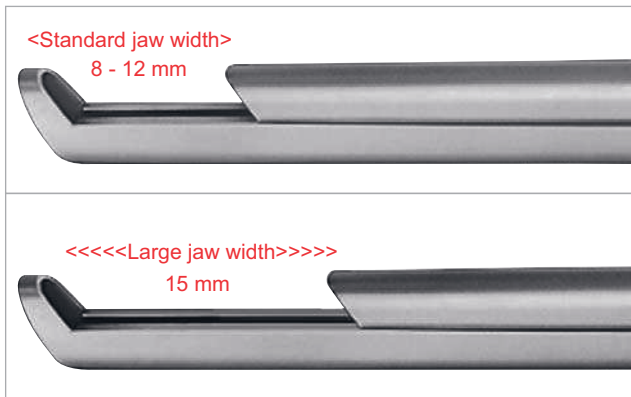
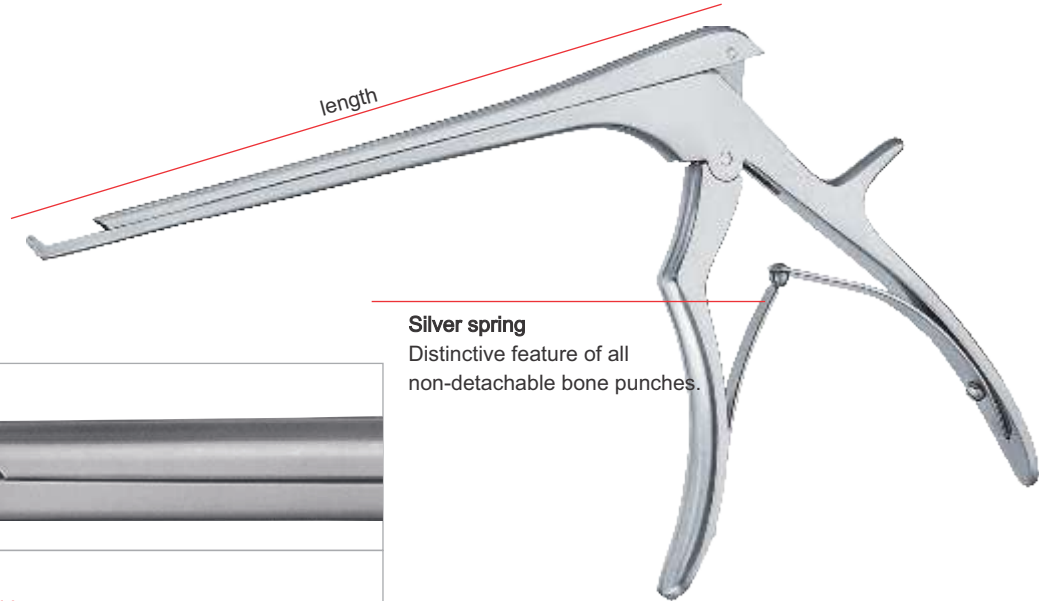



# Neurosurgery

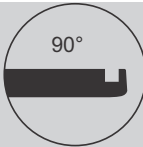
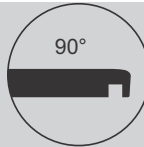
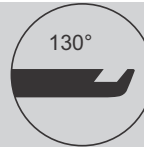
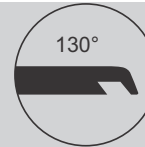









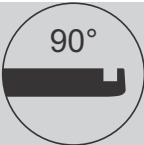
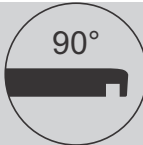
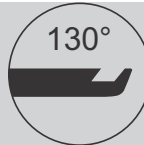
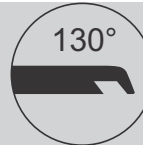

Standard

Lengths - 180 mm









Width (mm)		upward	downward	130° upward	130° downward	Jaw Width
						
1.0		NF.13.03.01	NF.13.03.11	NF.13.03.21	NF.13.03.31	8 mm
1.5				NF.13.101.03		15 mm
2.0		NF.13.03.02	NF.13.03.12	NF.13.03.22	NF.13.03.32	9 mm
				NF.13.101.05		15 mm
2.5				NF.13.101.06		10 mm
				NF.13.101.07		15 mm
3.0		NF.13.03.03	NF.13.03.13	NF.13.03.23	NF.13.03.33	10 mm
				NF.13.101.09		15 mm
4.0		NF.13.03.04	NF.13.03.14	NF.13.03.24	NF.13.03.34	12 mm
				NF.13.101.11		15 mm
5.0		NF.13.03.05	NF.13.03.15	NF.13.03.25	NF.13.03.35	12 mm
				NF.13.101.13		15 mm
6.0		NF.13.03.06	NF.13.03.16	NF.13.03.26	NF.13.03.36	12 mm
				NF.13.101.15		15 mm

## Standard

### Lengths - 200 mm

Width (mm)	upward	downward	130° upward	130° downward	Jaw Width
					
1.0			-		-
1.5			NF.13.102.02		9 mm
2.0			NF.13.102.04		9 mm
			NF.13.102.05		15 mm
2.5			NF.13.102.06		10 mm
3.0			NF.13.102.08		10 mm
			NF.13.102.09		15 mm
4.0			NF.13.102.10		12 mm
			NF.13.102.11		15 mm
5.0			NF.13.102.12		12 mm
			NF.13.102.13		15 mm
6.0			NF.13.102.14		12 mm
			NF.13.102.15		15 mm

### Lengths - 230 mm

1.0			-	-	-
1.5			-	-	-
2.0			NF.13.103.02	NF.13.103.42	9 mm
2.5			-	-	-
3.0			NF.13.103.08	NF.13.103.48	10 mm
4.0			NF.13.103.10	NF.13.103.50	12 mm
5.0			NF.13.103.12	NF.13.103.52	12 mm
6.0			-	-	-

## Delicate

### Thin footplate

These Kerrison punches feature a distinctive golden distal end.

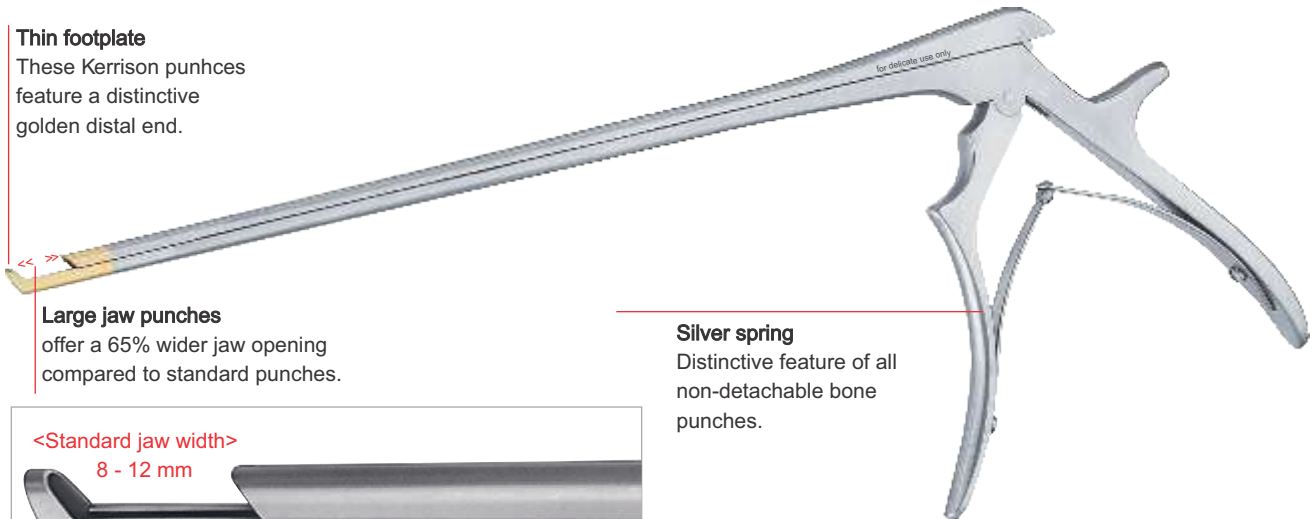

### Large jaw punches

offer a 65% wider jaw opening compared to standard punches.

### Silver spring

Distinctive feature of all non-detachable bone punches.

<Standard jaw width>  
8 - 12 mm



Thin

### Lengths - 180 mm

Width (mm)	upward	downward	130° upward	130° downward	Jaw Width
	90°	90°	130°	130°	
1.0	□		NF.13.111.01	NF.13.111.41	8 mm
1.5	□		NF.13.111.02		9 mm
2.0	□		NF.13.111.04	NF.13.111.44	9 mm
2.5	□		NF.13.111.06		10 mm
3.0	□		NF.13.111.08	NF.13.111.48	10 mm
4.0	□		NF.13.111.10	NF.13.111.50	12 mm
5.0	□		NF.13.111.12	NF.13.111.52	12 mm









### Lengths - 200 mm

1.0	□		NF.13.112.01		8 mm
1.5	□		NF.13.112.02		9 mm
2.0	□		NF.13.112.04		9 mm
2.5	□		NF.13.112.06		10 mm
3.0	□		NF.13.112.08		10 mm
4.0	□		NF.13.112.10		12 mm
5.0	□		NF.13.112.12		12 mm





# Neurosurgery

## Thin

### Lengths - 230 mm

Width (mm)	upward	downward	130° upward	130° downward	Jaw Width
					
2.0 			NF.13.113.02	NF.13.113.42	9 mm
3.0 			NF.13.113.08	NF.13.113.48	10 mm
4.0 			NF.13.113.10	NF.13.113.50	12 mm
5.0 			NF.13.113.12	NF.13.113.52	12 mm

### Lengths - 280 mm

2.0 			NF.13.114.02		9 mm
3.0 			NF.13.114.08		10 mm
4.0 			NF.13.114.10		12 mm
5.0 			NF.13.114.12		12 mm



## Detachable

- Easy disassembly and assembly
- Efficient cleaning and sterilization
- Nothing can be lost

**for delicate use only** Punches with a thin footplate are used exclusively for removing small portions of bone and soft tissue



## Ejector

for easy removal of punched-out material.

The detachable bone punches are identified by their **golden spring**

## Disassembly in 3 steps:

1. Unhook the spring from the rear handle.



2. Close the handle completely and pull the inner handle downwards.

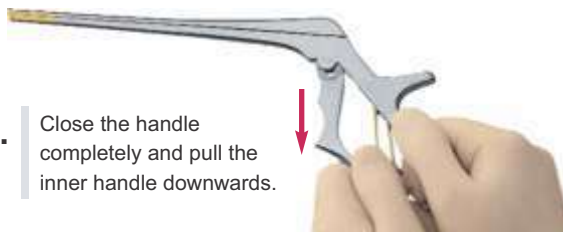

3. Pull back the slider to remove.















**Detachable KERRISON** punches with thin footplate clearly recognizable by the golden distal end.











## Standard

### Lengths - 180 mm







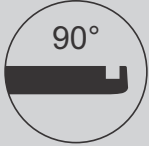
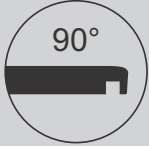
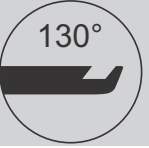
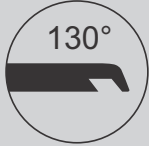

Width (mm)	upward	downward	130° upward	130° downward	Jaw Width	Ejector	
							
1.0		NF.13.03.231	NF.13.03.241	NF.13.101.101	NF.13.101.141	8 mm	
1.5				NF.13.101.102		9 mm	
				NF.13.101.103		15 mm	
2.0		NF.13.03.232	NF.13.03.242	NF.13.101.104	NF.13.101.144	9 mm	
				NF.13.101.105		15 mm	
2.5				NF.13.101.106		10 mm	
				NF.13.101.107		15 mm	
3.0		NF.13.03.233	NF.13.03.243	NF.13.101.108	NF.13.101.148	10 mm	✓
				NF.13.101.109		15 mm	✓
4.0		NF.13.03.234	NF.13.03.244	NF.13.101.110	NF.13.101.150	12 mm	✓
				NF.13.101.111		15 mm	✓
5.0		NF.13.03.235	NF.13.03.245	NF.13.101.112	NF.13.101.152	12 mm	✓
				NF.13.101.113		15 mm	✓
6.0		NF.13.03.236	NF.13.03.246	NF.13.101.114		12 mm	✓
				NF.13.101.115		15 mm	✓

### Lengths - 200 mm

1.0				-		-	
1.5				NF.13.102.102		9 mm	
2.0				NF.13.102.104		9 mm	
				NF.13.102.105		15 mm	
2.5				NF.13.102.106		10 mm	
3.0				NF.13.102.108		10 mm	✓
				NF.13.102.109		15 mm	✓
4.0				NF.13.102.110		12 mm	✓
				NF.13.102.111		15 mm	✓
5.0				NF.13.102.112		12 mm	✓
				NF.13.102.113		15 mm	✓
6.0				NF.13.102.114		12 mm	✓
				NF.13.102.115		15 mm	✓







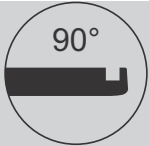
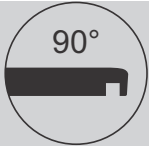
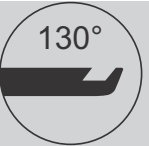

## Standard

### Length - 230 mm







Width (mm)	upward	downward	130° upward	130° downward	Jaw Width	Ejector
						
1.0			-	-	-	
1.5			-	-	-	
2.0			NF.13.103.102	NF.13.103.142	9 mm	
2.5			-	-	-	
3.0			NF.13.103.108	NF.13.103.148	10 mm	✓
4.0			NF.13.103.110	NF.13.103.150	12 mm	✓
5.0			NF.13.103.112	NF.13.103.152	12 mm	✓
6.0			-	-	-	

## Thin

### Length - 180 mm









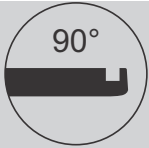

Width (mm)	upward	downward	130° upward	130° downward	Jaw Width	Ejector
						
1.0			NF.13.111.101	NF.13.111.141	8 mm	
1.5			NF.13.111.102		9 mm	
2.0			NF.13.111.104	NF.13.111.144	9 mm	
2.5			NF.13.111.106		10 mm	
3.0			NF.13.111.108	NF.13.111.148	10 mm	✓
4.0			NF.13.111.110	NF.13.111.150	12 mm	✓
5.0			NF.13.111.112	NF.13.111.152	12 mm	✓

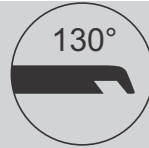
### Length - 200 mm







1.0			NF.13.112.101		8 mm	
1.5			NF.13.112.102		9 mm	
2.0			NF.13.112.104		9 mm	
2.5			NF.13.112.106		10 mm	
3.0			NF.13.112.108		10 mm	✓
4.0			NF.13.112.110		12 mm	✓
5.0			NF.13.112.112		12 mm	✓

## Thin

### Lengths - 230 mm

Width (mm)	upward	downward	130° upward	130° downward	Jaw Width	Ejector
						
1.0			-	-	-	
1.5			-	-	-	
2.0			NF.13.113.102	NF.13.113.142	9 mm	
2.5			-	-	-	
3.0			NF.13.113.108	NF.13.113.148	10 mm	✓
4.0			NF.13.113.110	NF.13.113.150	12 mm	✓
5.0			NF.13.113.112	NF.13.113.152	12 mm	✓

### Lengths - 280 mm

1.0			-	-	-	
1.5			-	-	-	
2.0			NF.13.114.102		9 mm	
2.5			-	-	-	
3.0			NF.13.114.108		10 mm	✓
4.0			NF.13.114.110		12 mm	✓
5.0			NF.13.114.112		12 mm	✓

## Non Glare

- Easy disassembly and assembly
- Coating

Coated KERRISON punches

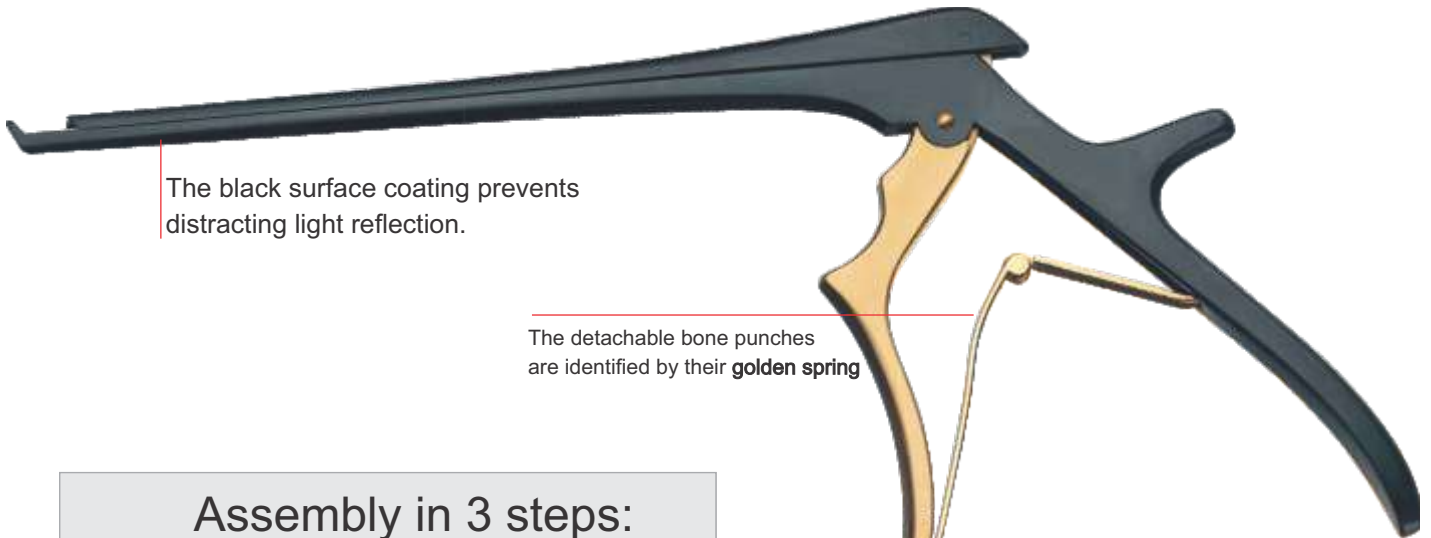

The black surface coating prevents distracting light reflection.

The detachable bone punches are identified by their **golden spring**

## Assembly in 3 steps:

1. Attach the slider and push it forwards.

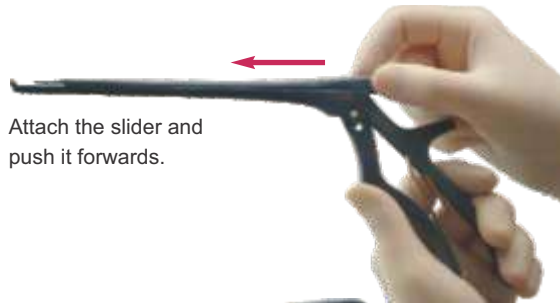

2. Push the inner handle upwards and open the handle.

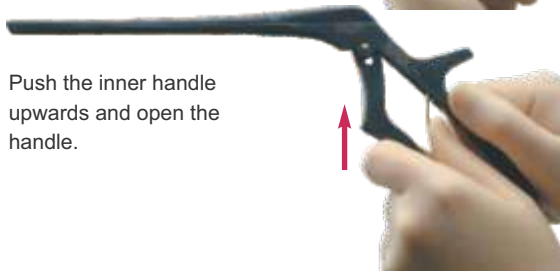

3. Insert the spring in the rear handle.











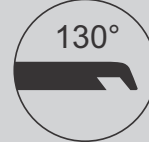

Kerrison punches with a thin footplate are identified by their golden inner handle.

**Ejector** for easy removal of punched-out material.











Standard      Coated KERRISON punches

Lengths - 180 mm

Width (mm)	upward	downward	130° upward	130° downward	Jaw Width	Ejector
						
1.0		NF.13.101.241		NF.13.101.201	8 mm	
1.5				NF.13.101.202	9 mm	
				NF.13.101.203	15 mm	
2.0		NF.13.101.244		NF.13.101.204	9 mm	
				NF.13.101.205	15 mm	
2.5				NF.13.101.206	10 mm	
				NF.13.101.207	15 mm	
3.0		NF.13.101.248		NF.13.101.208	10 mm	✓
				NF.13.101.209	15 mm	✓
4.0		NF.13.101.250		NF.13.101.210	12 mm	✓
				NF.13.101.211	15 mm	✓
5.0		NF.13.101.252		NF.13.101.212	12 mm	✓
				NF.13.101.213	15 mm	✓
6.0		NF.13.101.254		NF.13.101.214	12 mm	✓
				NF.13.101.215	15 mm	✓

Lengths - 200 mm

1.0			-		-	
1.5				NF.13.102.202	9 mm	
2.0				NF.13.102.204	9 mm	
				NF.13.102.205	15 mm	
2.5				NF.13.102.206	10 mm	
3.0				NF.13.102.208	10 mm	✓
				NF.13.102.209	15 mm	✓
4.0				NF.13.102.210	12 mm	✓
				NF.13.102.211	15 mm	✓
5.0				NF.13.102.212	12 mm	✓
				NF.13.102.213	15 mm	✓
6.0				NF.13.102.214	12 mm	✓
				NF.13.102.215	15 mm	✓

## Thin Coated KERRISON punches

### Lengths - 180 mm

Width (mm)    upward    downward    130° upward    130° downward    Jaw Width    Ejector

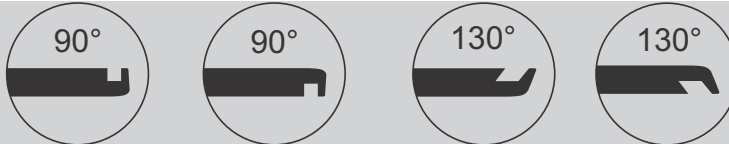

1.0					NF.13.111.201	8 mm	
1.5					NF.13.111.202	9 mm	
2.0					NF.13.111.204	9 mm	
2.5					NF.13.111.206	10 mm	
3.0					NF.13.111.208	10 mm	✓
4.0					NF.13.111.210	12 mm	✓
5.0					NF.13.111.212	12 mm	✓
6.0					NF.13.101.254	12 mm	✓

### Lengths - 200 mm

1.0					NF.13.112.201	8 mm	
1.5					NF.13.112.202	9 mm	
2.0					NF.13.112.204	9 mm	
2.5					NF.13.112.206	10 mm	
3.0					NF.13.112.208	10 mm	✓
4.0					NF.13.112.210	12 mm	✓
5.0					NF.13.112.212	12 mm	✓

### Lengths - 230 mm

2.0					NF.13.113.202	9 mm	
3.0					NF.13.113.208	10 mm	✓
4.0					NF.13.113.210	12 mm	✓
5.0					NF.13.113.212	12 mm	✓

### Lengths - 280 mm

2.0					NF.13.114.202	9 mm	
3.0					NF.13.114.208	10 mm	✓
4.0					NF.13.114.210	12 mm	✓
5.0					NF.13.114.212	12 mm	✓

## Special KERRISON punches

### Curved KERRISON punch, upbiting

Classic non-detachable bone punch with an upbiting curved jaw for easy removal of bone material, especially from between the vertebral arches.



### Lengths - 200 mm

Width (mm)	Art. No.	Jaw Width
2.0 □	NF.13.151.02	10 mm
3.0 □	NF.13.151.03	10 mm
4.0 □	NF.13.151.04	10 mm
5.0 □	NF.13.151.05	10 mm







## Bayonet-shaped KERRISON punch, 130° upbiting

Classic non-detachable bayonet-shaped bone punch for optimal vision over the shaft of the instrument in the operating area.

## Special KERRISON punches



Lengths - 240 mm





Width (mm)	Art. No.	Jaw Width
2.0 	NF.13.152.02	10 mm
3.0 	NF.13.152.03	10 mm
4.0 	NF.13.152.04	10 mm
5.0 	NF.13.152.05	10 mm

## Bayonet-shaped KERRISON punch, 130° upbiting

Classic non-detachable bayonet-shaped bone punch for optimal vision over the shaft of the instrument in the operating area.



Lengths - 240 mm

Width (mm)	Art. No.	Jaw Width
2.0 	NF.13.153.02	10 mm
3.0 	NF.13.153.03	10 mm
4.0 	NF.13.153.04	10 mm
5.0 	NF.13.153.05	10 mm

For removal of intervertebral disc tissue we offer an extensive assortment of rongeurs. Your advantages are:

1. All rongeurs are also available as detachable models enabling an effective cleaning. Connections and joints are freely accessible which avoids unwashed areas. By effected easily and quickly. The detached rongeurs stay stay one part and can be assembled again without any problems.
2. The black coating guarantees a reflexion free working as well as hard surface.



The detached rongeur remains one part.

The black coating aids reflections.

The diameter is marked on the rongeurs twice.

The golden handle refers to the detachability.

## Disassembly



Hold the rongeur with both hands and pull the release button.



For cleaning purposes please move the sliding part upwards.

## Assembly



Please insert the sliding part so that the release button is over the loop of the handle part.



Please keep the release button pulled and push the sliding part down.

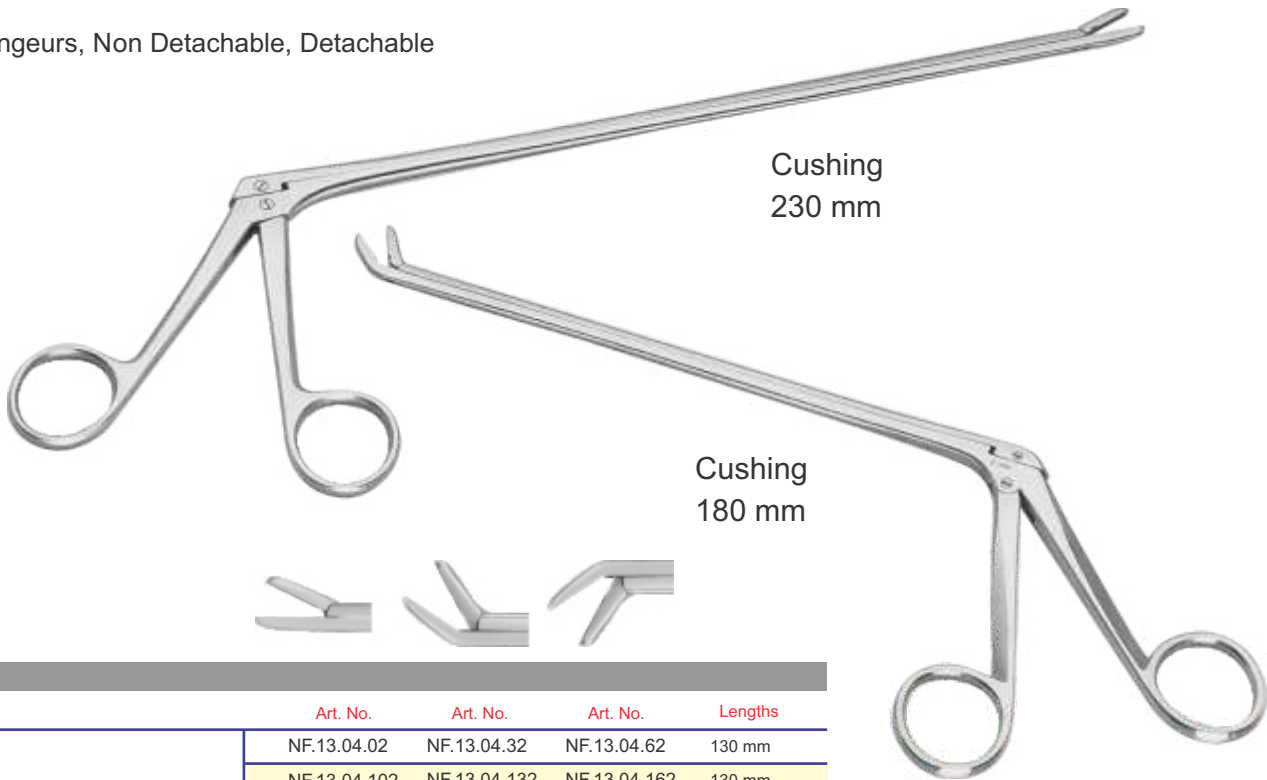

# Neurosurgery

Rongeurs, Non Detachable, Detachable



Cushing  
230 mm

Cushing  
180 mm



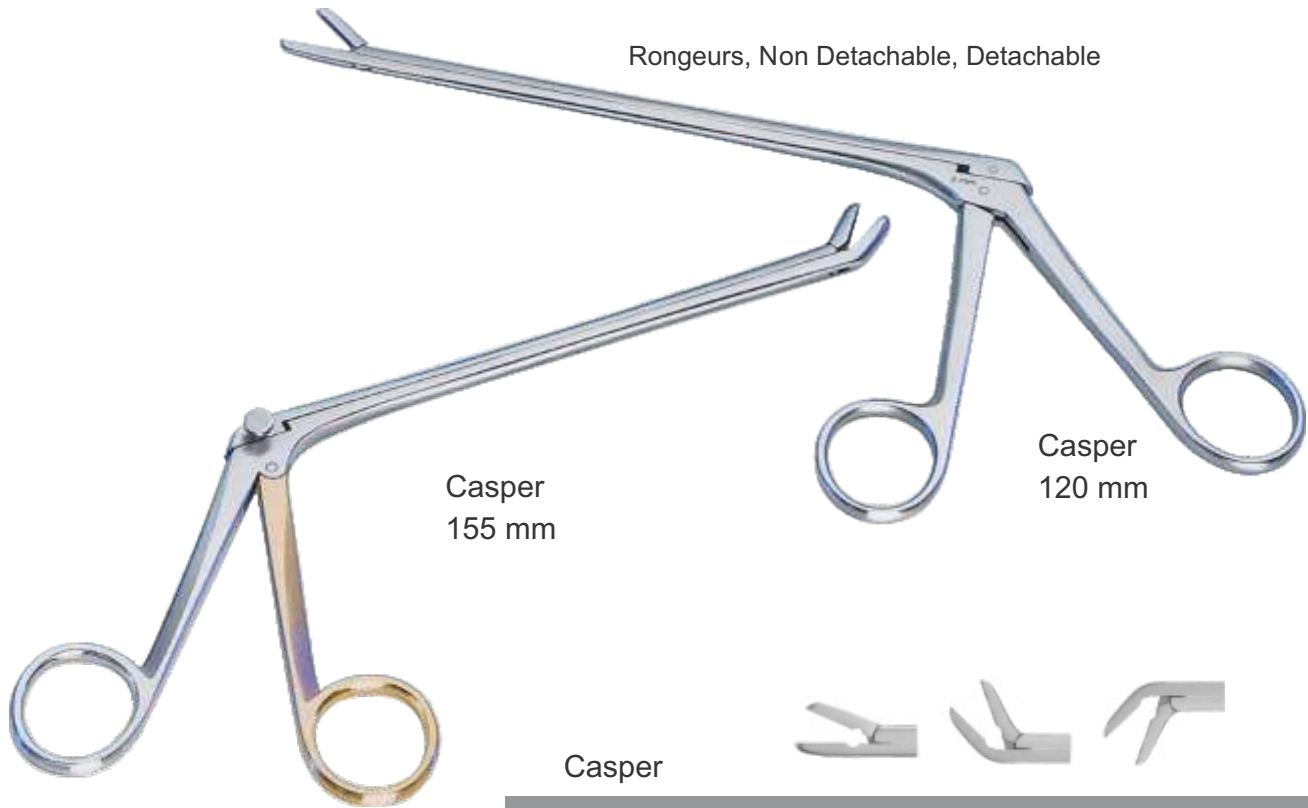

	Art. No.	Art. No.	Art. No.	Lengths
<b>CUSHING</b> 2 x 10 mm 	NF.13.04.02	NF.13.04.32	NF.13.04.62	130 mm
	NF.13.04.102	NF.13.04.132	NF.13.04.162	130 mm
	NF.13.04.15	NF.13.04.45	NF.13.04.75	150 mm
	NF.13.04.115	NF.13.04.145	NF.13.04.175	150 mm
	NF.13.04.22	NF.13.04.52	NF.13.04.82	180 mm
	NF.13.04.122	NF.13.04.152	NF.13.04.182	180 mm
	NF.13.04.23	NF.13.04.53	NF.13.04.83	230 mm
	NF.13.04.123	NF.13.04.153	NF.13.04.183	230 mm
	NF.13.04.28	NF.13.04.58	NF.13.04.88	280 mm
	NF.13.128	NF.13.04.158	NF.13.04.188	280 mm
<b>LOVE-GRUENWALD</b> 3 x 10 mm 	NF.13.08.03	NF.13.08.33	NF.13.08.63	130 mm
	NF.13.08.103	NF.13.08.133	NF.13.08.163	130 mm
	NF.13.08.15	NF.13.08.45	NF.13.08.75	150 mm
	NF.13.08.115	NF.13.08.145	NF.13.08.175	150 mm
	NF.13.08.23	NF.13.08.53	NF.13.08.83	180 mm
	NF.13.08.123	NF.13.08.153	NF.13.08.183	180 mm
	NF.13.08.24	NF.13.08.54	NF.13.08.84	230 mm
	NF.13.08.124	NF.13.08.154	NF.13.08.184	230 mm
	NF.13.08.28	NF.13.08.58	NF.13.08.88	280 mm
	NF.13.08.128	NF.13.08.158	NF.13.08.188	280 mm
<b>SPURLING</b> 4 x 10 mm 	NF.13.11.83	NF.13.11.93	NF.13.11.94	130 mm
	NF.13.11.183	NF.13.11.193	NF.13.11.194	130 mm
	NF.13.11.85	NF.13.11.95	NF.13.11.96	150 mm
	NF.13.11.185	NF.13.11.195	NF.13.11.196	150 mm
	NF.13.11.88	NF.13.11.98	NF.13.11.99	180 mm
	NF.13.11.188	NF.13.11.198	NF.13.11.199	180 mm
	NF.13.11.89	NF.13.11.99	NF.13.11.100	230 mm
	NF.13.11.189	NF.13.11.199	NF.13.11.201	230 mm
	NF.13.11.90	NF.13.11.101	NF.13.11.102	280 mm
	NF.13.11.190	NF.13.11.201	NF.13.11.202	280 mm

non detachable  
 detachable

Rongeurs, Non Detachable, Detachable



Casper

	Art. No.	Art. No.	Art. No.	Lengths
2 mm 	NF.13.05.54	NF.13.05.64	NF.13.05.74	120 mm
	NF.13.05.154	NF.13.05.164	NF.13.05.174	120 mm
	NF.13.05.56	NF.13.05.66	NF.13.05.76	155 mm
	NF.13.05.156	NF.13.05.166	NF.13.05.176	155 mm
	NF.13.05.58	NF.13.05.68	NF.13.05.78	180 mm
	NF.13.05.158	NF.13.05.168	NF.13.05.178	180 mm
3 mm 	NF.13.06.54	NF.13.06.64	NF.13.06.74	120 mm
	NF.13.06.154	NF.13.06.164	NF.13.06.174	120 mm
	NF.13.06.56	NF.13.06.66	NF.13.06.76	155 mm
	NF.13.06.156	NF.13.06.166	NF.13.06.176	155 mm
	NF.13.06.58	NF.13.06.68	NF.13.06.78	180 mm
	NF.13.06.158	NF.13.06.168	NF.13.06.178	180 mm
4 mm 	NF.13.07.54	NF.13.07.64	NF.13.07.74	120 mm
	NF.13.07.154	NF.13.07.164	NF.13.07.174	120 mm
	NF.13.07.56	NF.13.07.66	NF.13.07.76	155 mm
	NF.13.07.156	NF.13.07.166	NF.13.07.176	155 mm
	NF.13.07.58	NF.13.07.68	NF.13.07.78	180 mm
	NF.13.07.158	NF.13.07.168	NF.13.07.178	180 mm
5 mm 	NF.13.09.54	NF.13.09.64	NF.13.09.74	120 mm
	NF.13.09.154	NF.13.09.164	NF.13.09.174	120 mm
	NF.13.09.56	NF.13.09.66	NF.13.09.76	155 mm
	NF.13.09.156	NF.13.09.166	NF.13.09.176	155 mm
	NF.13.09.58	NF.13.09.68	NF.13.09.78	180 mm
	NF.13.09.158	NF.13.09.168	NF.13.09.178	180 mm

non detachable

detachable



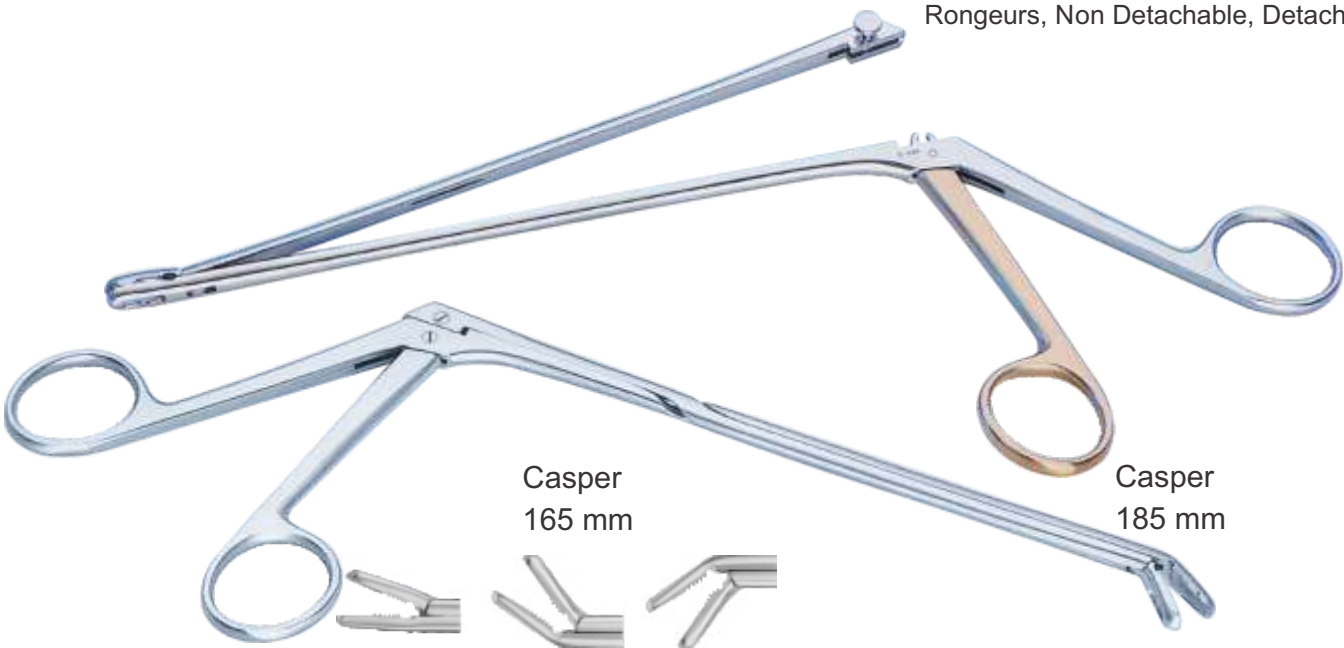

# Neurosurgery

Rongeurs, Non Detachable, Detachable



Casper  
165 mm

Casper  
185 mm

	Art. No.	Art. No.	Art. No.	Lengths
2 x 12 mm 	NF.13.05.04	NF.13.05.34	NF.13.05.44	140 mm
	NF.13.05.104	NF.13.05.134	NF.13.05.144	140 mm
	NF.13.05.06	NF.13.05.36	NF.13.05.46	160 mm
	NF.13.05.106	NF.13.05.136	NF.13.05.146	160 mm
	NF.13.05.08	NF.13.05.38	NF.13.05.48	185 mm
	NF.13.05.108	NF.13.05.138	NF.13.05.148	185 mm
3 x 12 mm 	NF.13.06.04	NF.13.06.34	NF.13.06.44	140 mm
	NF.13.06.104	NF.13.06.134	NF.13.06.144	140 mm
	NF.13.06.06	NF.13.06.36	NF.13.06.46	160 mm
	NF.13.06.106	NF.13.06.136	NF.13.06.146	160 mm
	NF.13.06.08	NF.13.06.38	NF.13.06.48	185 mm
	NF.13.06.108	NF.13.06.138	NF.13.06.148	185 mm
4 x 14 mm 	NF.13.07.04	NF.13.07.34	NF.13.07.44	140 mm
	NF.13.07.104	NF.13.07.134	NF.13.07.144	140 mm
	NF.13.07.06	NF.13.07.36	NF.13.07.46	160 mm
	NF.13.07.106	NF.13.07.136	NF.13.07.146	160 mm
	NF.13.07.08	NF.13.07.38	NF.13.07.48	185 mm
	NF.13.07.108	NF.13.07.138	NF.13.07.148	185 mm
5 x 14 mm 	NF.13.09.04	NF.13.09.34	NF.13.09.44	140 mm
	NF.13.09.104	NF.13.09.134	NF.13.09.144	140 mm
	NF.13.09.06	NF.13.09.36	NF.13.09.46	160 mm
	NF.13.09.106	NF.13.09.136	NF.13.09.146	160 mm
	NF.13.09.08	NF.13.09.38	NF.13.09.48	185 mm
	NF.13.09.108	NF.13.09.138	NF.13.09.148	185 mm
6 x 16 mm 	NF.13.10.04	NF.13.10.34	NF.13.10.44	140 mm
	NF.13.10.104	NF.13.10.134	NF.13.10.144	140 mm
	NF.13.10.06	NF.13.10.36	NF.13.10.46	160 mm
	NF.13.10.106	NF.13.10.136	NF.13.10.146	160 mm
	NF.13.10.08	NF.13.10.38	NF.13.10.48	185 mm
	NF.13.10.108	NF.13.10.138	NF.13.10.148	185 mm



Mouth fenestrated and serrated

non detachable  
 detachable

## Laminectomy Rongeurs

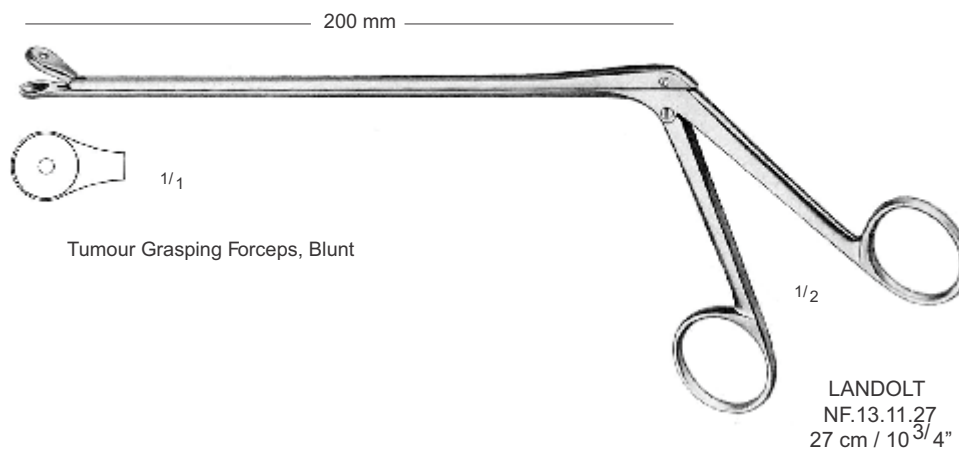
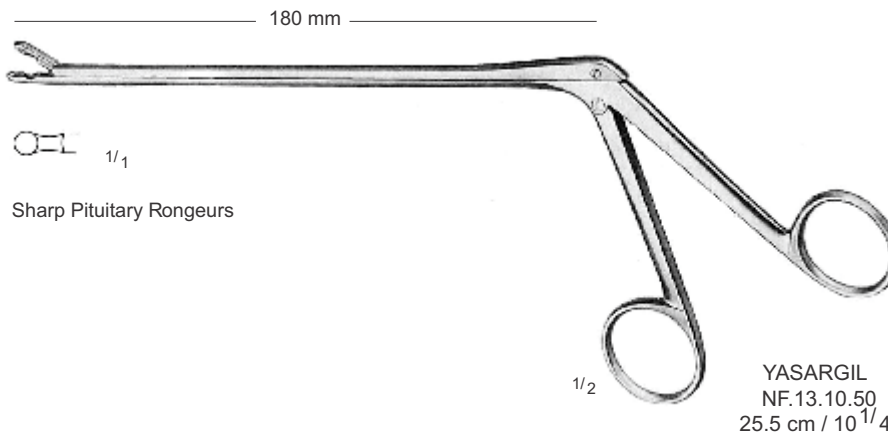
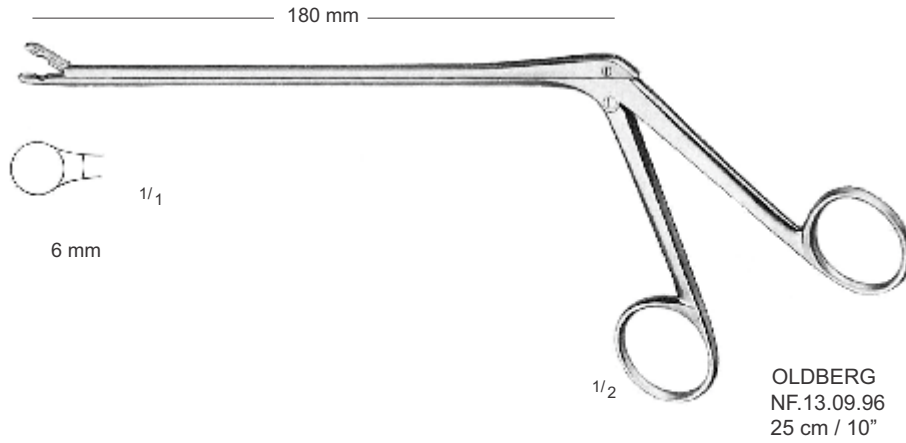

## Brain Spatulas, Dura Dissectors

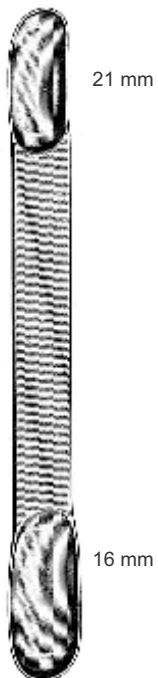

**CUSHING**  
NF.13.15.17 – 17 cm / 6<sup>3</sup>/<sub>4</sub>"  
NF.13.15.20 – 20 cm / 8"

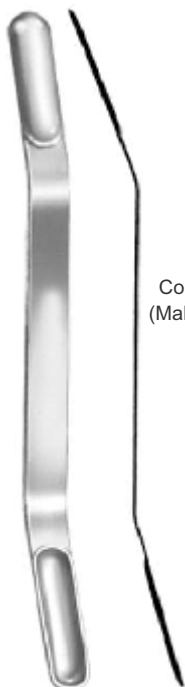

Concave  
(Malleable)

**OILVECRONA**  
18 cm (7<sup>1</sup>/<sub>8</sub>")  
NF.13.16.09 – 7 + 9 mm  
NF.13.16.13 – 11 + 13 mm  
NF.13.16.18 – 15 + 18 mm  
NF.13.16.22 – 18 + 22 mm

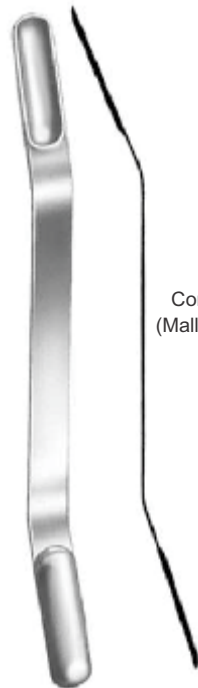

Convex  
(Malleable)

**OILVECRONA**  
18 cm (7<sup>1</sup>/<sub>8</sub>")  
NF.13.17.39 – 7 + 9 mm  
NF.13.17.43 – 11 + 13 mm  
NF.13.17.48 – 15 + 18 mm  
NF.13.17.52 – 18 + 22 mm



1/1



1/2

**FRAZIER**  
NF.13.18.01  
15 cm / 6"



1/2

**HOEN**  
NF.13.18.02  
15 cm / 6"



1/2

**HOEN**  
NF.13.18.03  
15 cm / 6"

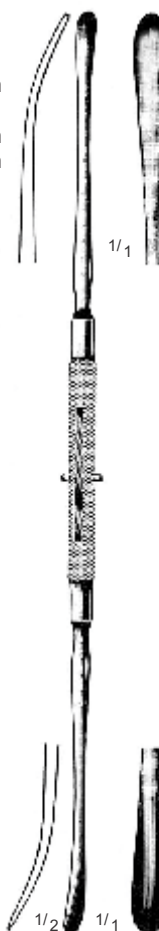

1/2

1/1

**DAVIS**  
NF.13.41.24  
24.5 cm / 9<sup>3</sup>/<sub>4</sub>"



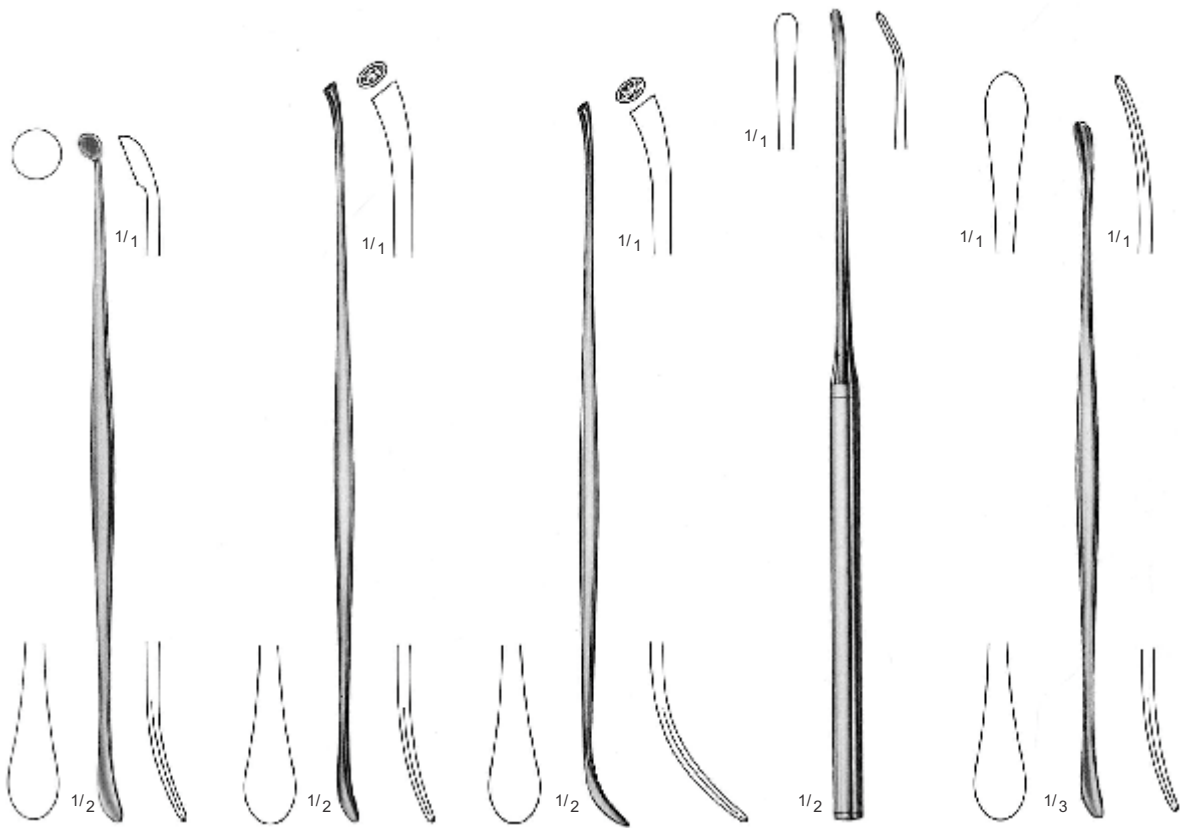

PENFIELD  
NF.14.37.51  
Fig. 1  
17.5 cm / 7"

PENFIELD  
NF.14.37.52  
Fig. 2  
19.5 cm / 7<sup>3</sup>/<sub>4</sub>"

PENFIELD  
NF.14.37.53  
Fig. 3  
19.5 cm / 7<sup>3</sup>/<sub>4</sub>"

PENFIELD  
NF.14.38.54  
Fig. 4  
21.5 cm / 8<sup>1</sup>/<sub>2</sub>"

PENFIELD  
NF.14.39.55  
Fig. 5  
29 cm / 11<sup>1</sup>/<sub>2</sub>"

# Neurosurgery

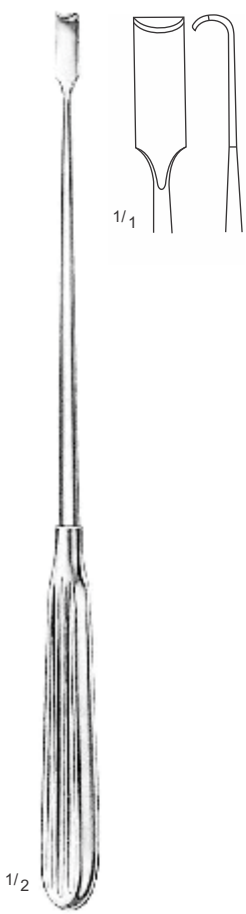

1/2  
**SCOVILLE**  
NF.14.42.50  
23 cm / 9"

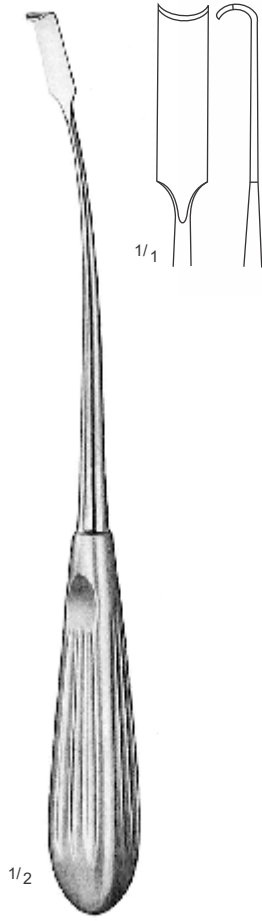

1/2  
**HOLSHER**  
NF.14.42.51  
24 cm / 9 1/2"



1/2  
**LOVE**  
NF.14.43.01 – NF.14.43.03

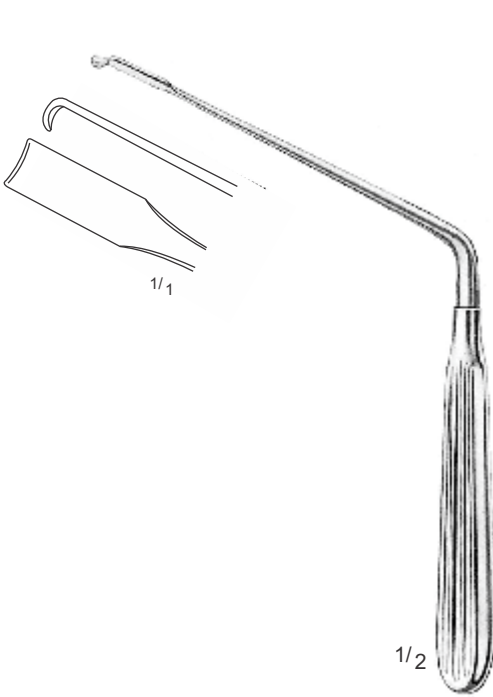

1/2  
**SCOVILLE**  
NF.14.43.51  
23 cm / 9"

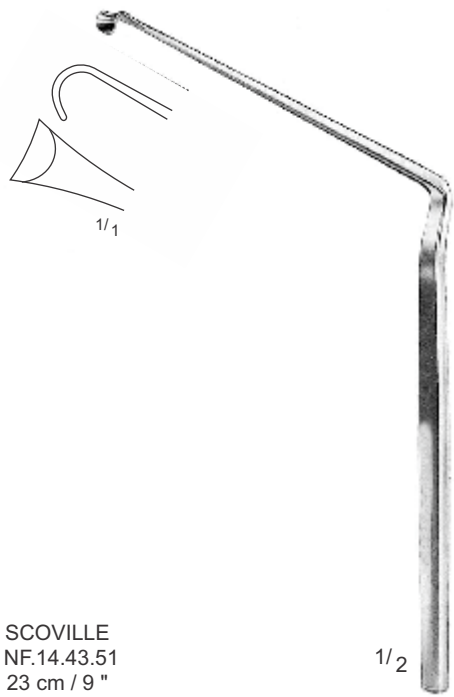

1/2  
**PROFESSIONAL**  
NF.14.44.52  
21 cm / 8 1/4"

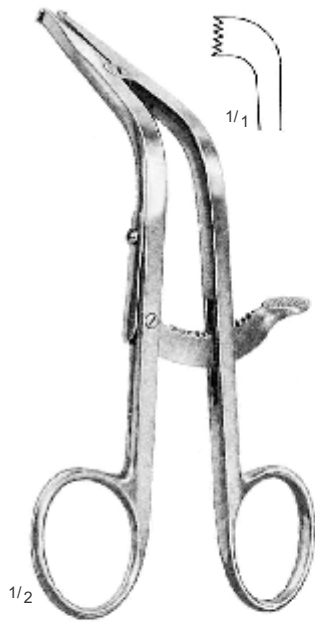

CLOWARD  
NF.14.49.75  
16 cm / 6 1/4"

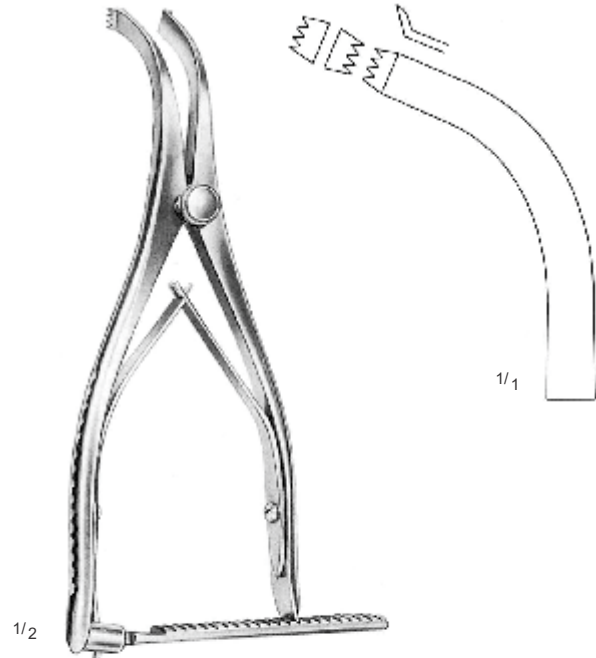

INGE  
NF.14.50.05  
16 cm / 6 1/4"

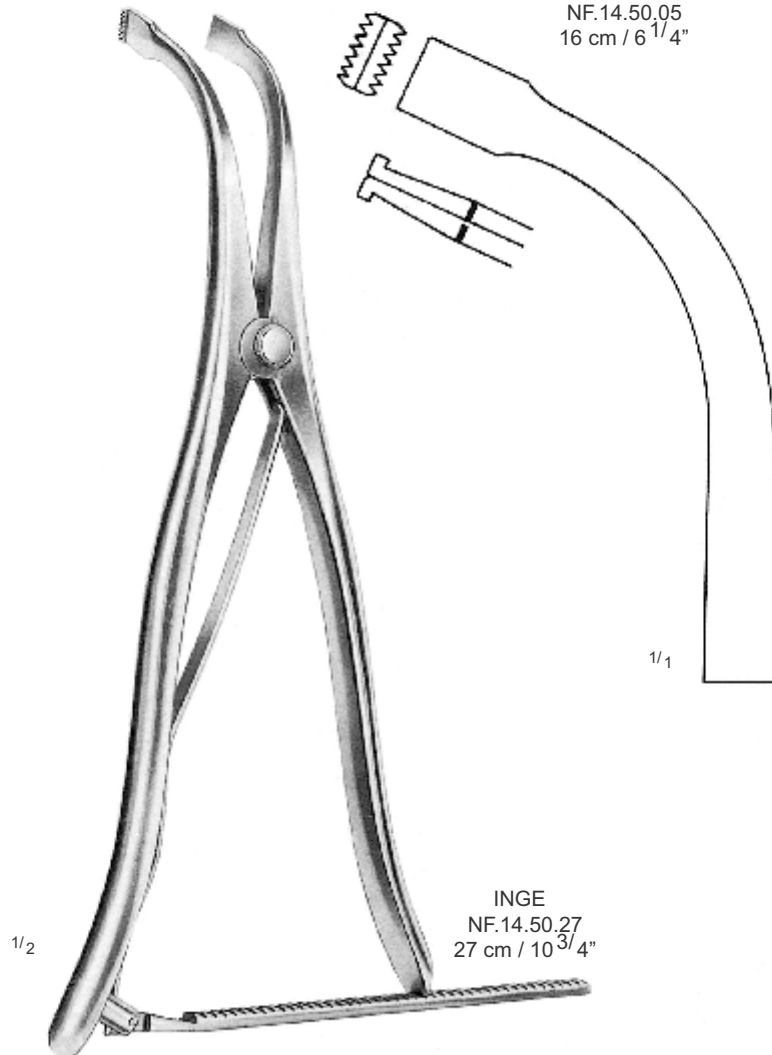

INGE  
NF.14.50.27  
27 cm / 10 3/4"

# Neurosurgery

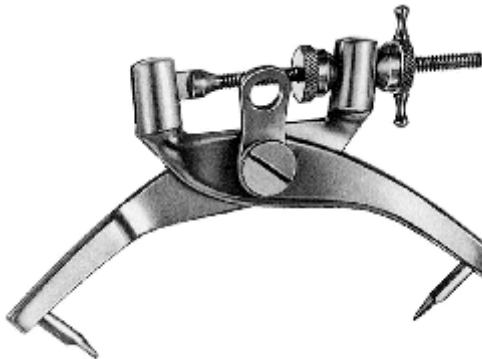

CRUTCHFIELD  
NF.14.52.01

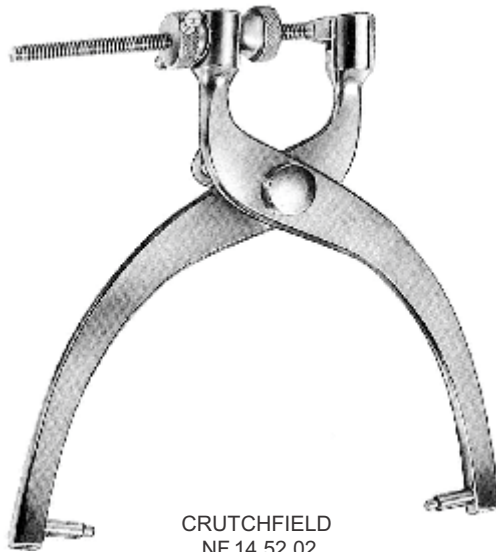

CRUTCHFIELD  
NF.14.52.02



NF.14.52.04  
ø 3.5 mm



NF.14.52.05  
ø 5 mm



EXTENSION PIECE  
ONLY  
NF.14.53.05



NF.14.54.09  
ø 9 mm



NF.14.54.14  
ø 14 mm



NF.14.55.16  
ø 16 mm



NF.14.55.22  
ø 22 mm



BRACE ONLY  
NF.14.54.03

HUDSON  
Cranial Drill  
Complete with 4  
burs No.,  
NF.14.54.09  
NF.14.54.14  
NF.14.55.16  
NF.14.55.22



CUSHING  
NF.14.56.34  
ø 13 mm



McKENZIE  
NF.14.57.43  
ø 13 mm



D'ERRICO  
NF.14.58.76  
ø 16 mm

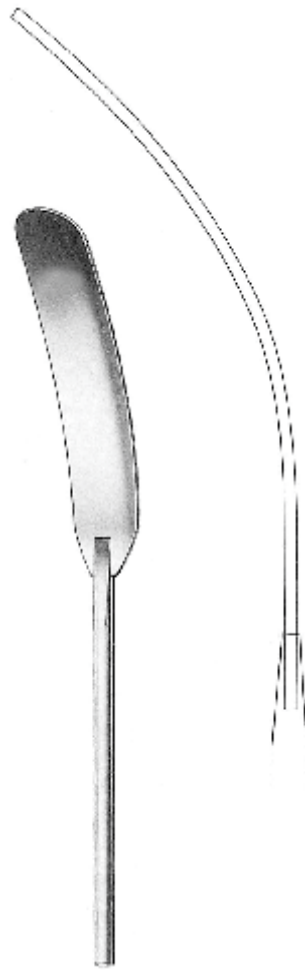

HEIFETZ  
20 cm / 8"

NF.14.70.68 8 mm  
NF.14.70.71 11 mm  
NF.14.70.74 14 mm  
NF.14.70.77 17 mm  
NF.14.70.80 20 mm



LEYLA  
NF.14.61.00  
Complete with two flexible arms no.NF.14. 61.02,  
one fixation base noNF.14. 61.01 and two clamps  
No. NF.14. 61.03 for holding brain spatulas

# Urology Instruments



# Urology Instruments

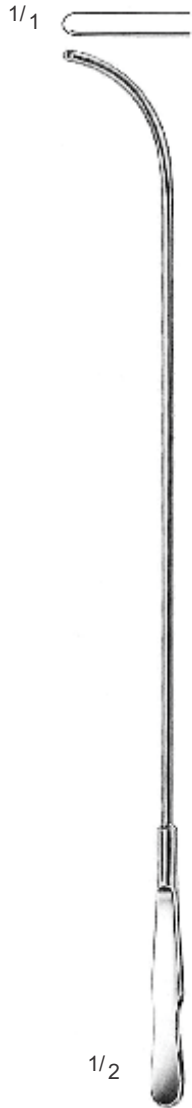

VAN BUREN  
NF.14.06.08 NF.14.06.30  
27.5 cm / 11"  
CHARRIER(French)  
No. (8-30)

**CHARRIERE**  
(French)

VAN BUREN	GUYON
NF.14.06.08 8	-
NF.14.06.10 10	NF.14.07.10
11	NF.14.07.11
NF.14.06.12 12	NF.14.07.12
13	NF.14.07.13
NF.14.06.14 14	NF.14.07.14
15	NF.14.07.15
NF.14.06.16 16	NF.14.07.16
17	NF.14.07.17
NF.14.06.18 18	NF.14.07.18
19	NF.14.07.19
NF.14.06.20 20	NF.14.07.20
21	NF.14.07.21
NF.14.06.22 22	NF.14.07.22
23	NF.14.07.23
NF.14.06.24 24	NF.14.07.24
25	NF.14.07.25
NF.14.06.26 26	NF.14.07.26
27	NF.14.07.27
NF.14.06.28 28	NF.14.07.28
29	NF.14.07.29
NF.14.06.30 30	NF.14.07.30

NF.14.06.00 (Set of 12, pcs)      NF.14.07.00 (Set 21, pcs)



GUYON  
NF.14.07.10 NF.14.07.30 NF.14.07.56 NF.14.07.66  
27.5 cm / 11"      16 cm / 6 1/4"  
CHARRIER(French)      CHARRIER(French)  
No. (10-30)      No. (6-16)



**CHARRIERE**  
(French)

NF.14.07.56 - 6  
NF.14.07.58 - 8  
NF.14.07.60 - 10  
NF.14.07.62 - 12  
NF.14.07.63 - 13  
NF.14.07.64 - 14  
NF.14.07.65 - 15  
NF.14.07.66 - 16



# Urology Instruments



GUYON  
NF.14.08.20  
36 cm/ 14¼"



GUYON  
NF.14.09.30  
36 cm/ 14¼"



DITTEL  
NF.14.10.60  
39 cm/ 15½"



NF.14.11.70  
39 cm/ 15½"

# Urology Instruments



35 mm

LEGUEU  
NF.14.16.15  
27 cm / 10½"

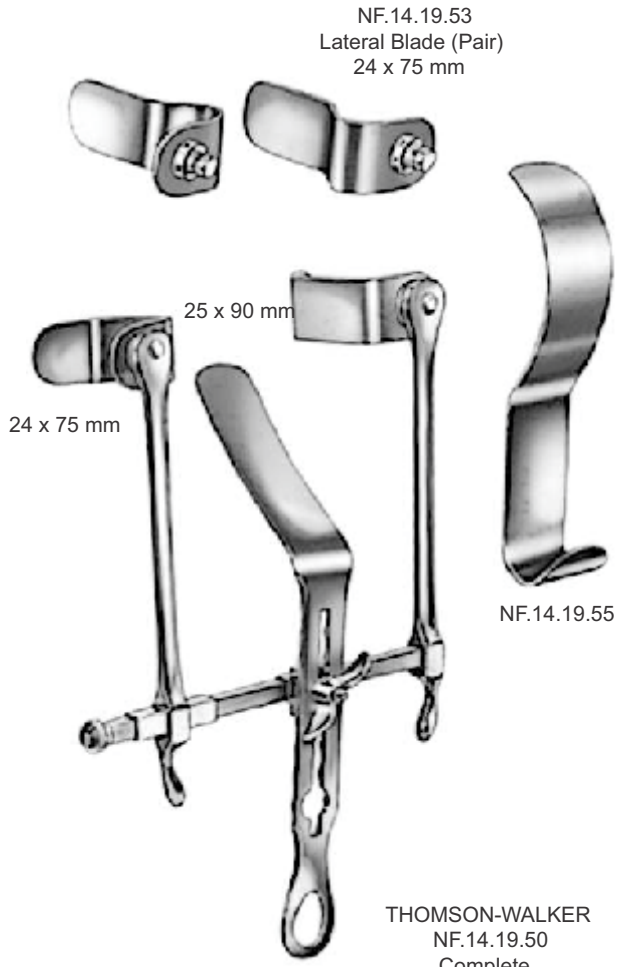

NF.14.19.53  
Lateral Blade (Pair)  
24 x 75 mm

24 x 75 mm

25 x 90 mm

NF.14.19.55

THOMSON-WALKER  
NF.14.19.50  
Complete

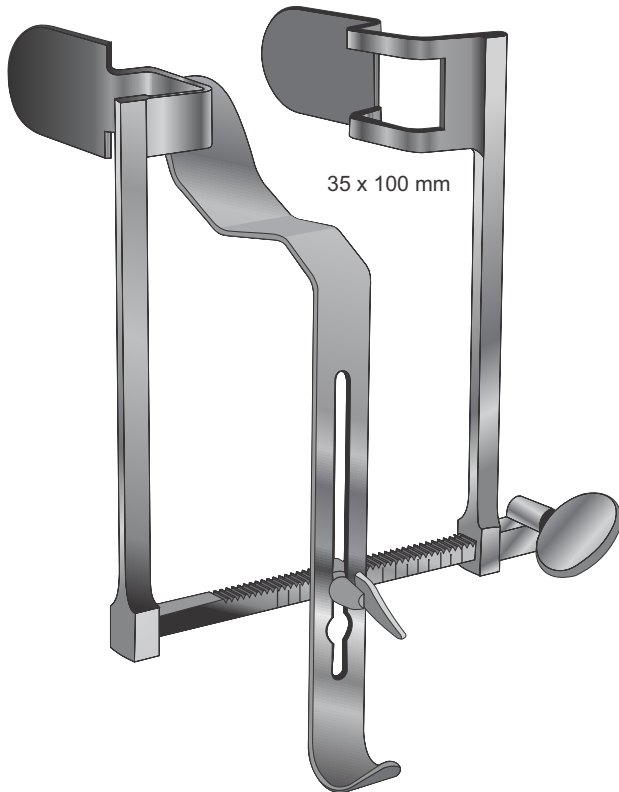

35 x 100 mm

HRYNTSHCAK  
NF.14.20.70

# Urology Instruments

11 x 50 mm

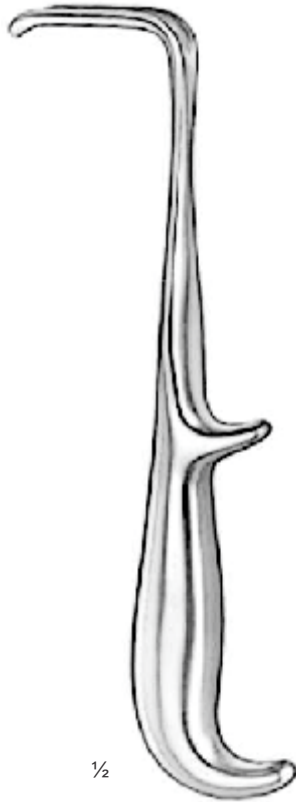

1/2

YOUNG  
NF.14.23.01  
21 cm / 8 1/4"

38 x 64 mm



1/2

YOUNG  
NF.14.24.02  
22 cm / 8 3/4"

25 x 25 mm



1/2

YOUNG  
NF.14.25.03  
21 cm / 8 1/4"

39 x 35 mm

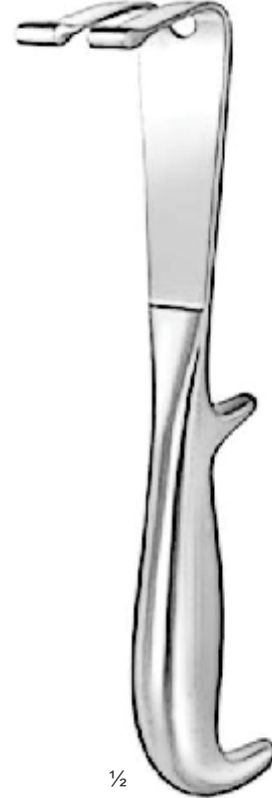

1/2

YOUNG  
NF.14.28.04  
22 cm / 8 3/4"

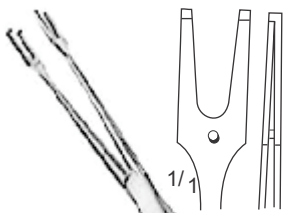

1/1

1/3

MILLIN  
NF.14.26.03  
24 cm / 9 1/2"

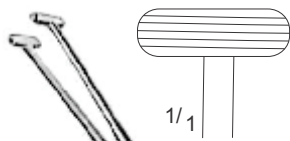

1/1

1/3

MILLIN  
NF.14.31.01  
23 cm / 9"

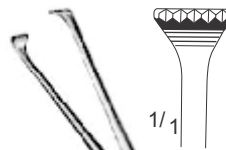

1/1

1/3

MILLIN  
NF.14.32.02  
23 cm / 9"

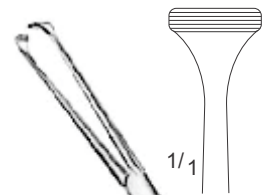

1/1

1/3

MILLIN  
NF.14.32.04  
23 cm / 9"

L = Length

W = Width

D = Depth

ø = Diameter

# Urology Instruments



½

**MILLIN**  
NF.14.33.50  
28 cm / 11"



½

**STRAUSS**  
NF.14.04.10  
12 cm / 4¾"



½

**STOCKMANN**  
NF.14.05.05  
8 cm / 3"

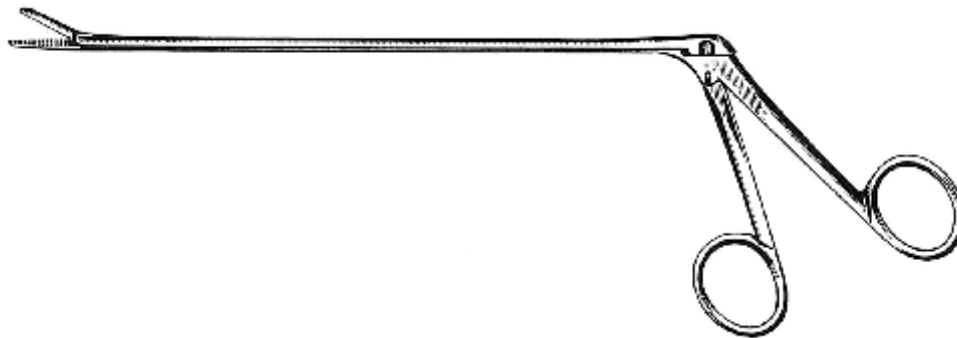

**MATHIEU**  
NF.14.21.20 NF.14.21.28  
20 cm / 8" 28 cm / 11"

# Urology Instruments

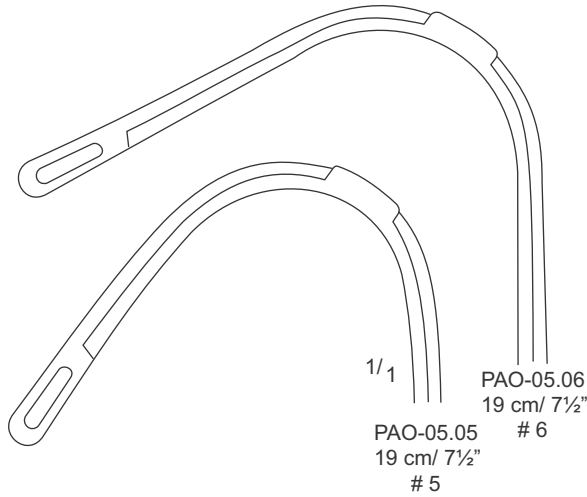

RANDALL  
PAO-05.01 PAO-05.06

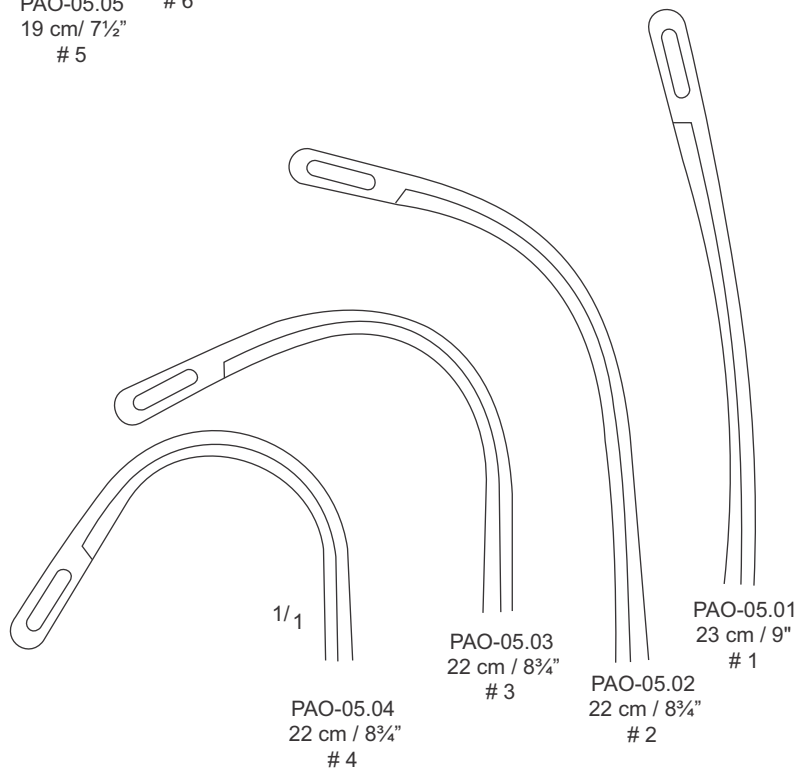

# Urology Instruments



1/2

GUYON  
PAO-15.20 PAO-15.24

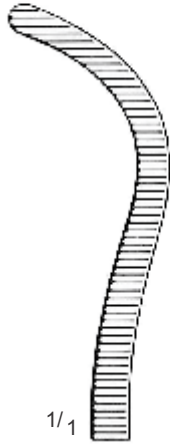

1/1

PAO-15.20  
20 cm / 8"

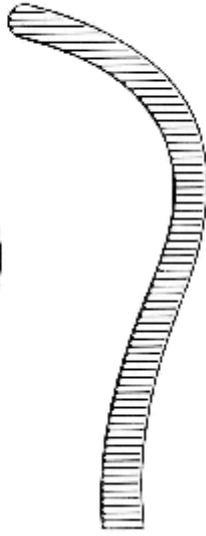

PAO-15.22  
22 cm / 8 3/4"

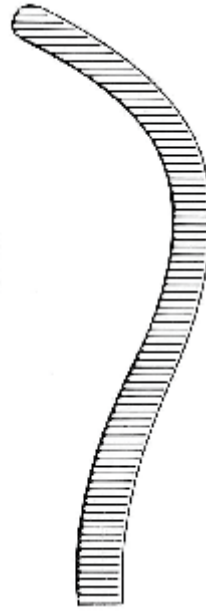

PAO-15.24  
24 cm / 9 1/2"

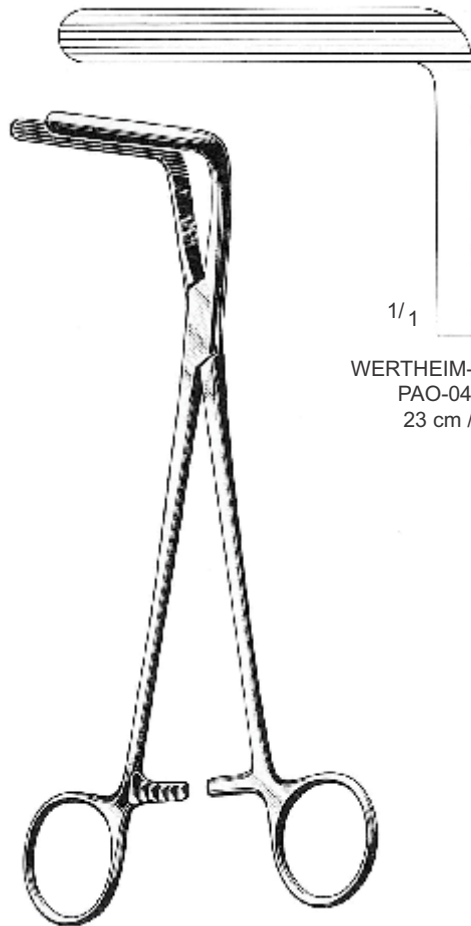

1/1

WERTHEIM-CULLEN  
PAO-04.23  
23 cm / 9"

# Urology Instruments

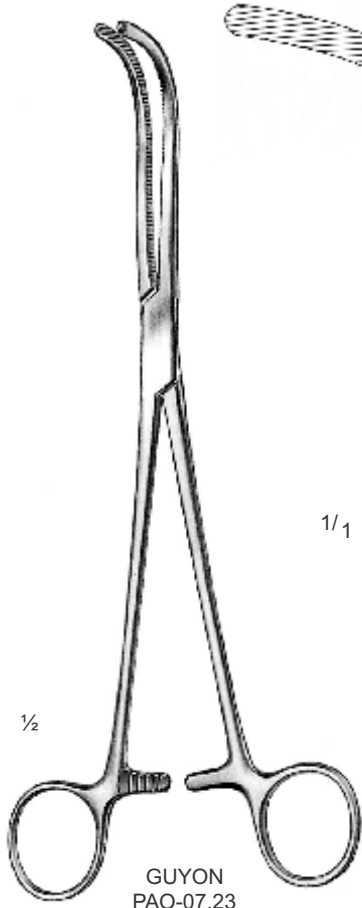

GUYON  
PAO-07.23



GUYON-MAYO  
PAO-08.23  
23 cm/ 9"

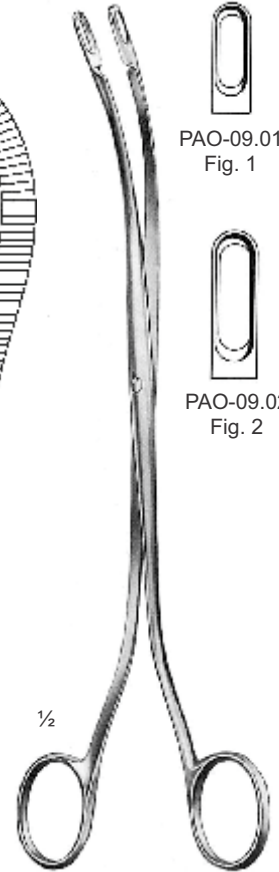
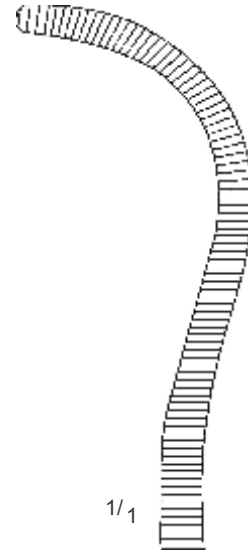

DESJARDINS  
PAO-09.01 PAO-09.02  
23 cm/ 9"

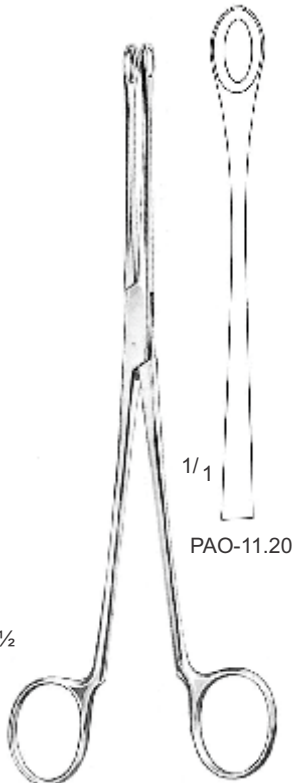

BLAKE  
20 cm/ 8"

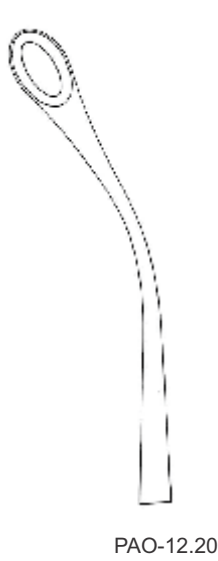

PAO-12.20

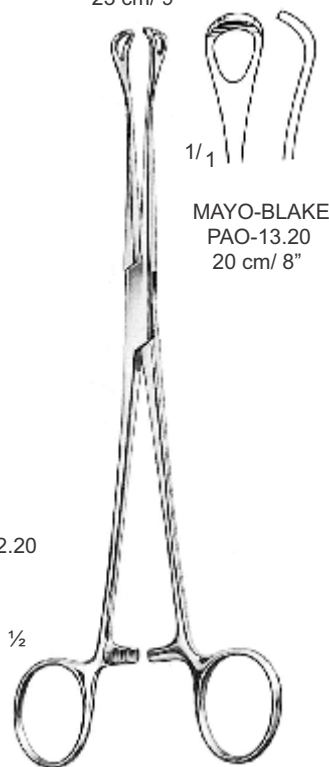

MAYO-BLAKE  
PAO-13.20  
20 cm/ 8"

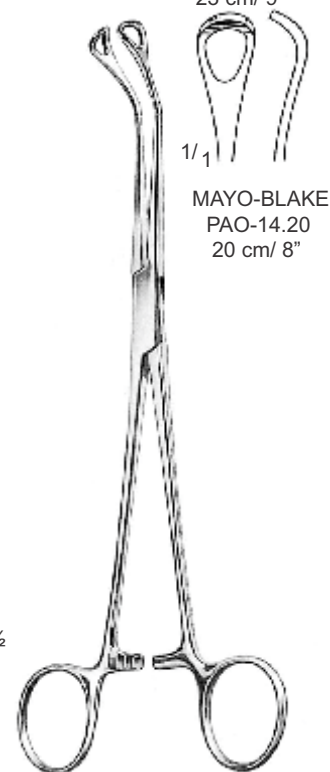

MAYO-BLAKE  
PAO-14.20  
20 cm/ 8"

# Urology Instruments



**THOREK**  
PAO-16.19 – 19 cm/ 7½"  
PAO-16.23 – 23 cm/ 9"

Side View

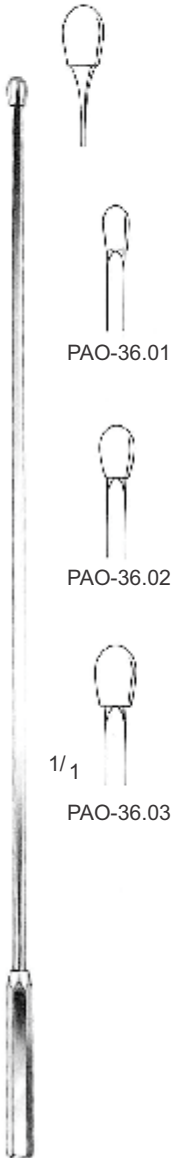

**DESJARDINS**  
PAO-36.01 PAO-36.03  
26 cm/ 10¼"  
  
PAO-36.00  
Set of 3 probes



**BAKES**  
PAO-32.01 PAO-32.13  
32 cm/ 13"  
Malleable Shaft  
PAO-32.00  
Set of 13 dilators

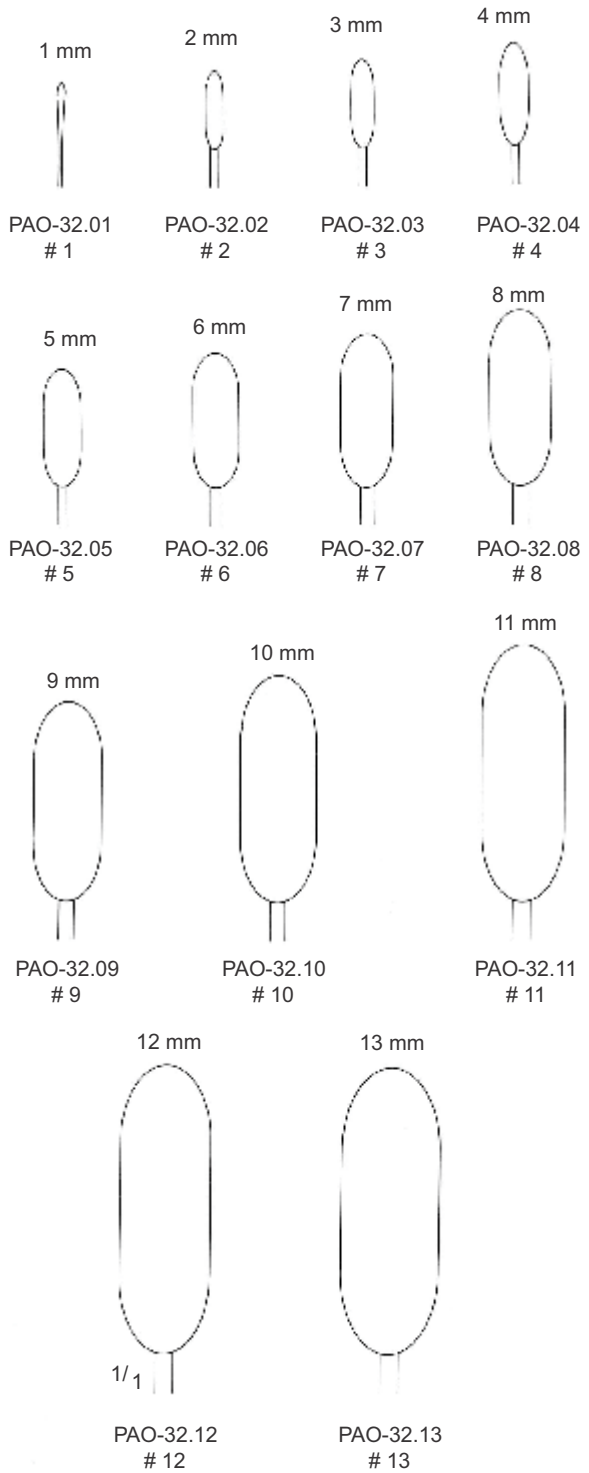

1 mm PAO-32.01 # 1  
2 mm PAO-32.02 # 2  
3 mm PAO-32.03 # 3  
4 mm PAO-32.04 # 4  
5 mm PAO-32.05 # 5  
6 mm PAO-32.06 # 6  
7 mm PAO-32.07 # 7  
8 mm PAO-32.08 # 8  
9 mm PAO-32.09 # 9  
10 mm PAO-32.10 # 10  
11 mm PAO-32.11 # 11  
12 mm PAO-32.12 # 12  
13 mm PAO-32.13 # 13



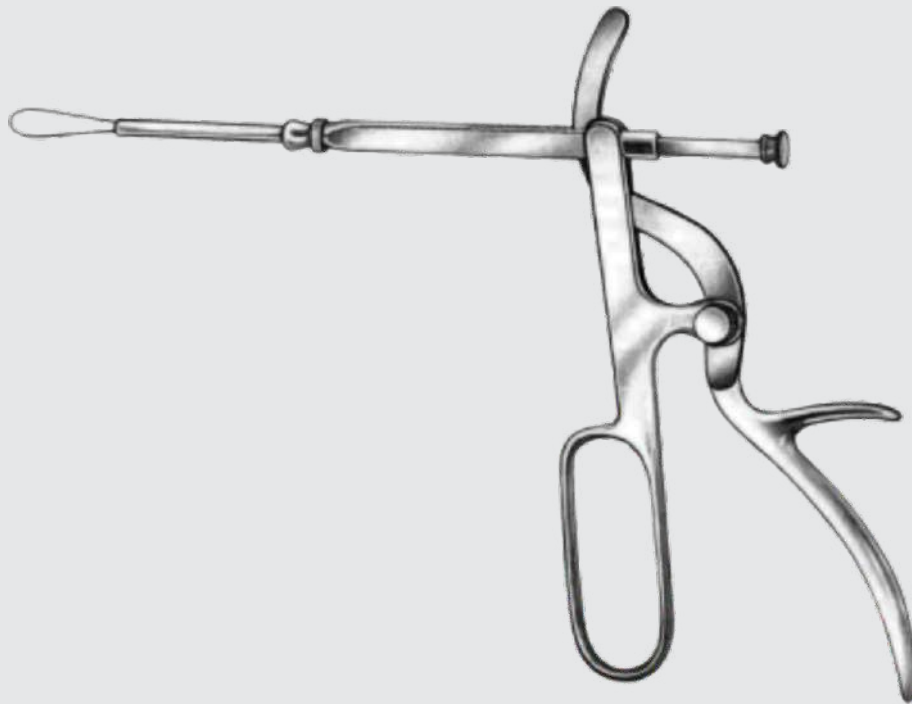

Delivery with 3 wires, pre shaped

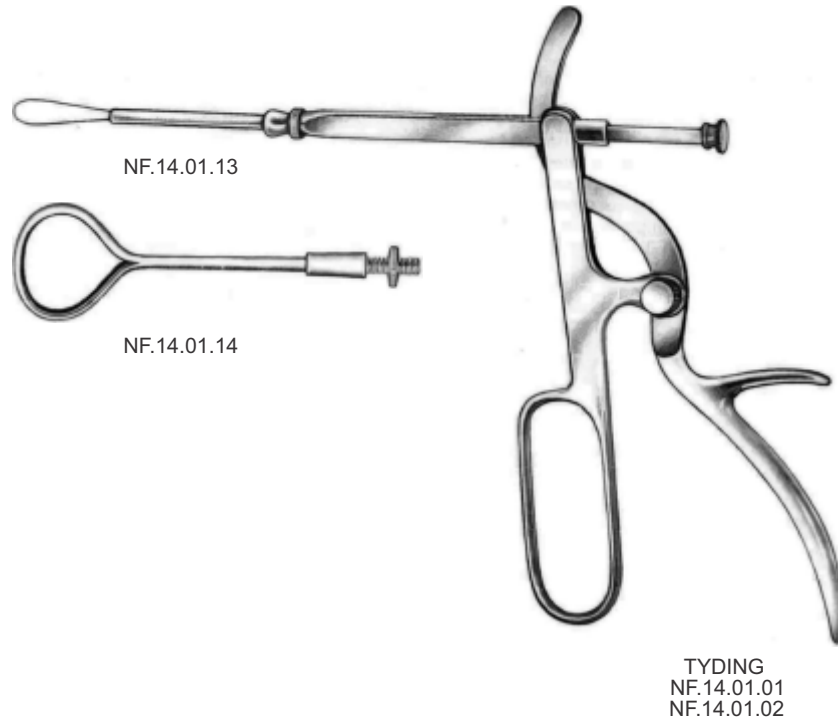

NF.14.01.01  
TYDING Tonsil snare with straight tip

NF.14.01.02  
TYDING Tonsil snare with straight and vedder looped tip

NF.14.01.13  
Straight tip only

NF.14.01.14  
Vedder Loop tip only

# Mouth & Throat Instruments

Snare Wires  
Snare Drähte  
Cables de la caja  
Fils de piège  
Fili Snare

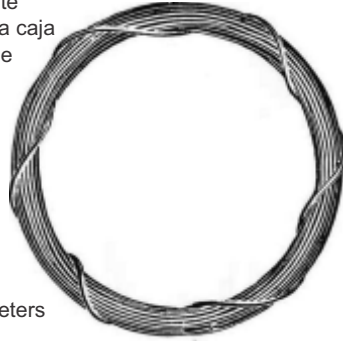

Coil/10 meters

For Tonsil Snares

NF.14.01.23 Ø 0.35 mm  
NF.14.01.24 Ø 0.40 mm  
NF.14.01.25 Ø 0.45 mm

Standard size Delivery with 3 wires, pre shaped

Delivery with 3 wire loops

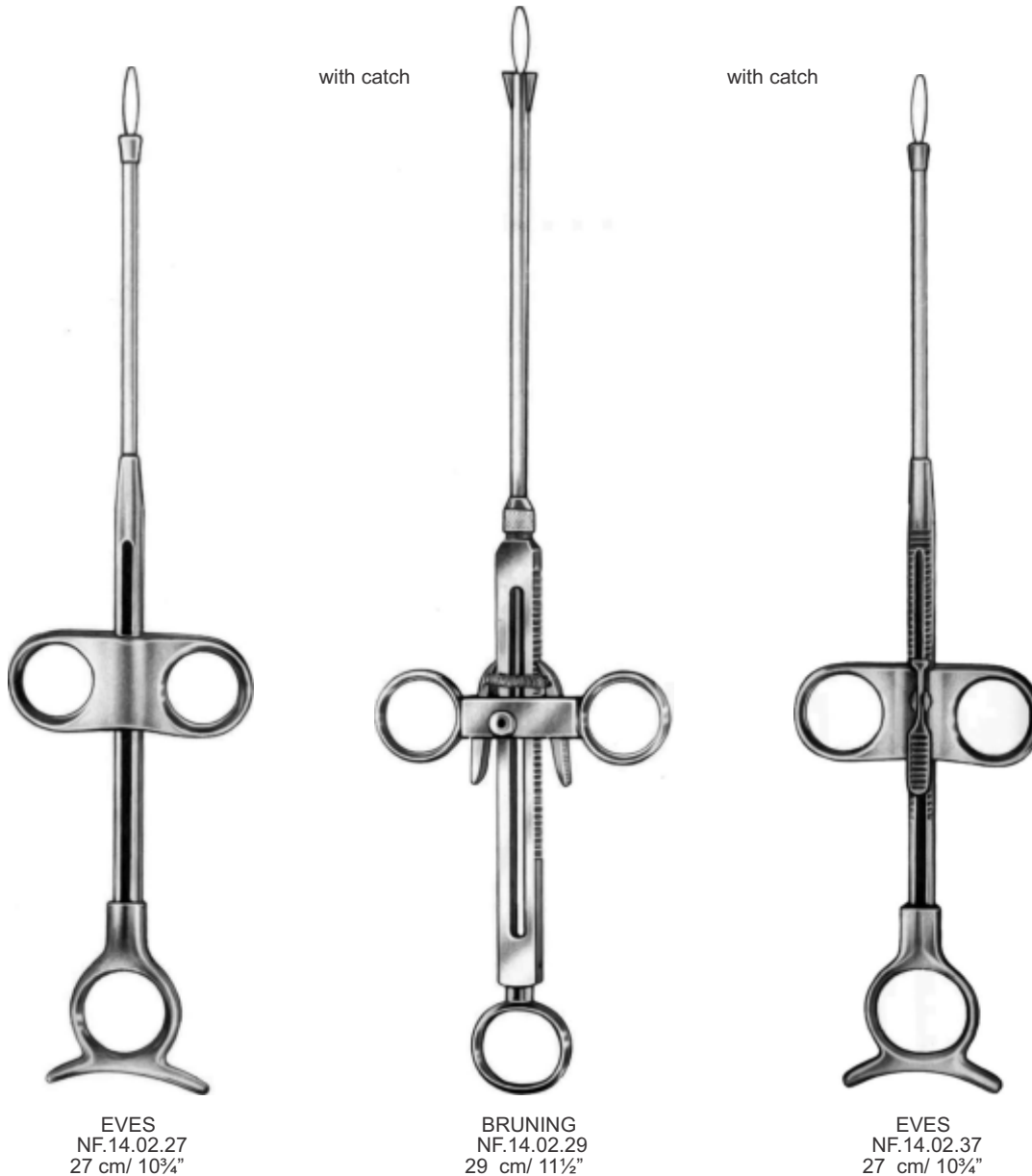

with catch

with catch

EVES  
NF.14.02.27  
27 cm/ 10¾"

BRUNING  
NF.14.02.29  
29 cm/ 11½"

EVES  
NF.14.02.37  
27 cm/ 10¾"

# Mouth & Throat Instruments

Tonsil Artery Forceps

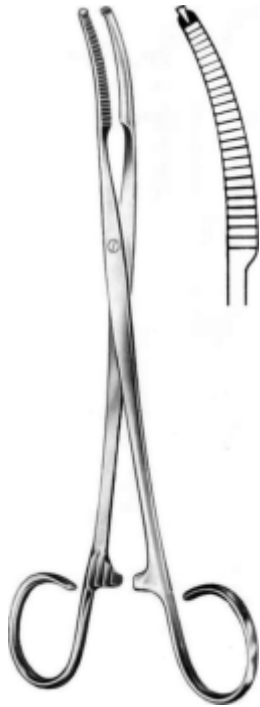

MIKULICZ  
NF.14.04.18  
18 cm / 7 1/8"

Tonsil Seizing Forceps



MARSCHIK  
NF.14.04.22  
22 cm / 8 3/4"



WHITE  
NF.14.04.23  
23 cm / 9"

# Mouth & Throat Instruments



WHITE  
NF.14.05.19  
18 cm / 7 $\frac{1}{8}$ "



COLVER  
NF.14.06.19  
19 cm / 7 $\frac{1}{2}$ "



ABRAHAM  
NF.14.06.22  
20.5 cm / 8 $\frac{1}{8}$ "

# Mouth & Throat Instruments

Delivery with 3 wires, pre shaped



LEWIS  
NF.14.02.45  
25.5 cm/ 8 $\frac{1}{8}$ "

For catgut loops



ROEDER "E"  
NF.14.02.47  
27 cm/ 10 $\frac{3}{4}$ "

# Mouth & Throat Instruments

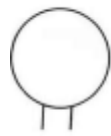

NF.14.03.13  
Ø 13 mm

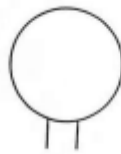

NF.14.03.15  
Ø 15 mm

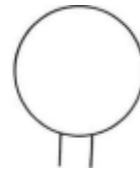

NF.14.03.17  
Ø 17 mm

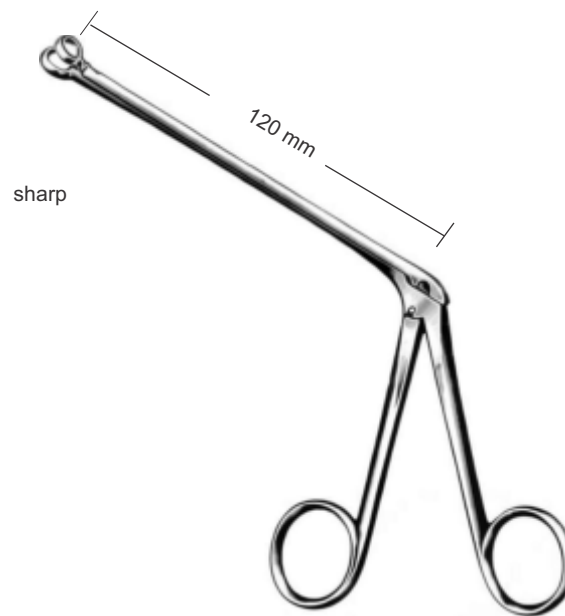

HARTMANN

# Mouth & Throat Instruments



Clamping forceps

NF.14.07.21  
19 cm / 7½"  
# 1

NEGUS



Ligature clamp

NF.14.07.22  
19 cm / 7½"  
# 2

NEGUS



MUCK  
18 cm / 7¼"



NF.14.07.31  
# 1 - 8 mm



NF.14.07.32  
# 2 - 10 mm



MCWORTHER-LOTHROP  
NF.14.07.38  
18.5 cm / 7¼"



# Mouth & Throat Instruments



BLOHMKE  
NF.14.09.20  
21 cm/ 8¼"



THILENIUS  
NF.14.09.30  
20 cm/ 8"

# Mouth & Throat Instruments



NF.14.11.18  
18 cm/ 7½"

CANFIELD  
NF.14.11.19  
21 cm/ 8¼"

ABRAHAM  
NF.14.12.20  
21 cm/ 8¼"

BRUNINGS  
NF.14.12.23  
23 cm/ 9"

DAY  
NF.14.12.40  
20 cm/ 8"

# Mouth & Throat Instruments



FISHER  
NF.14.13.20  
22.5 cm/ 9"



ABRAHAM(TYDING)  
NF.14.13.30  
20 cm/ 8"



NF.14.14.21  
21 cm/ 8¼"  
Ø 7 mm

Reversible, in screwable sheath



NF.14.14.22  
10 cm/ 4"  
Ø 4 mm

# Mouth & Throat Instruments

Tonsil Gauze Packer



LUNIATSCHECK  
NF.14.21.18  
18 cm / 7 $\frac{1}{8}$ "

# Mouth & Throat Instruments

1 Serrated blade



DEAN  
NF.14.25.17  
17 cm/ 6¾"



BOETTCHER  
NF.14.25.18  
18 cm/ 7½"



PRINCE  
NF.14.25.23  
18 cm/ 7½"



GOOD  
NF.14.25.30  
19 cm/ 7½"

# Mouth & Throat Instruments

Elevator

Elevator



**YANKAUER**  
NF.14.15.22  
21 cm/ 8¼"



NF.14.17.22  
6 + 12 mm



**HURD**  
22 cm/ 8¾"



NF.14.16.22  
10 + 12 mm



**ALDERDICE**  
NF.14.18.21  
22 cm/ 8¾"



**HENKE**  
NF.14.19.12  
24 cm/ 9½"  
12 + 18 mm

Tonsil Dissector with suction device

Enucleator

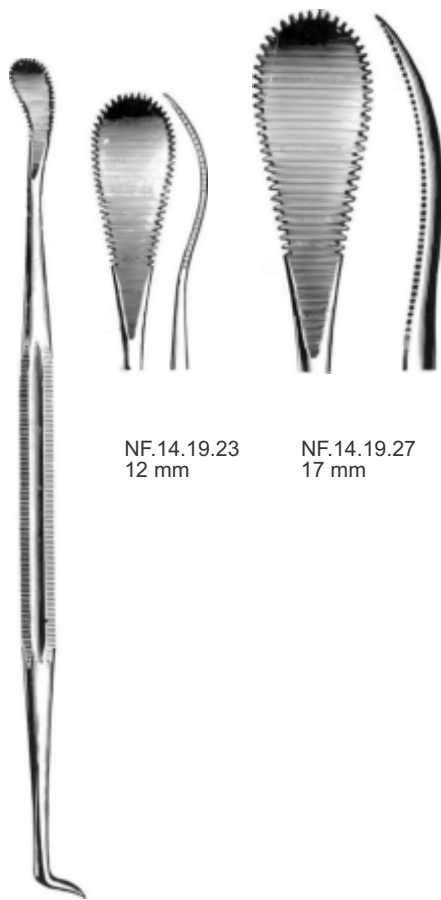

NF.14.19.23  
12 mm

NF.14.19.27  
17 mm

HENKE  
23 cm/ 9"

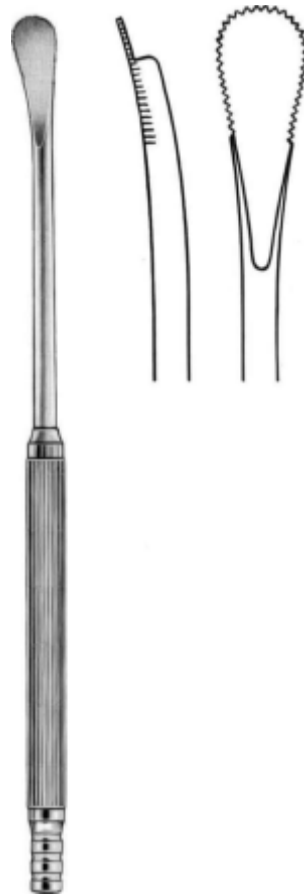

LOPEZ-REINKE  
NF.14.20.23  
23 cm/ 9"



CARPENTER  
NF.14.20.25  
25 cm/ 10"

# Mouth & Throat Instruments



NF.14.27.05  
Handle only

SLUDER-BALLENGER  
NF.14.27.00

Working shaft and blades in angled-up position to the handle, complete, with 1 blade each fig, 1, 2 and 3

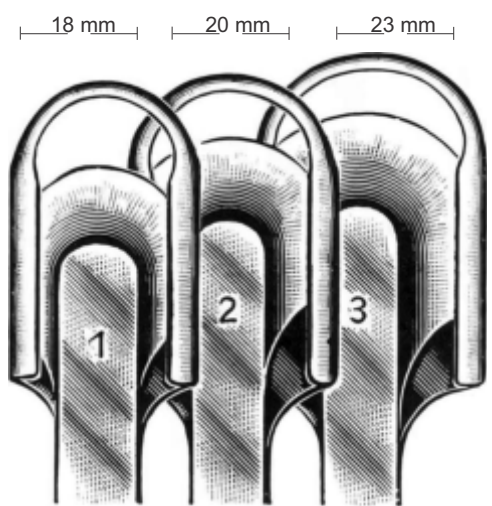

Blades only

NF.14.27.01 #1      NF.14.27.02 #2      NF.14.27.03 #3

SLUDER-BALLENGER



# Mouth & Throat Instruments

Rhinoscopic mirrors, movable



Without handle



Shaft 12 cm long (4 3/4")

With adjusting screw



NF.14.01.50  
11 cm / 4 3/4"

With chuck



NF.14.02.55  
11.5 cm / 4 1/2"



22 cm / 8 1/4"



NF.14.03.52



NF.14.03.54



NF.14.03.56



NF.14.03.58

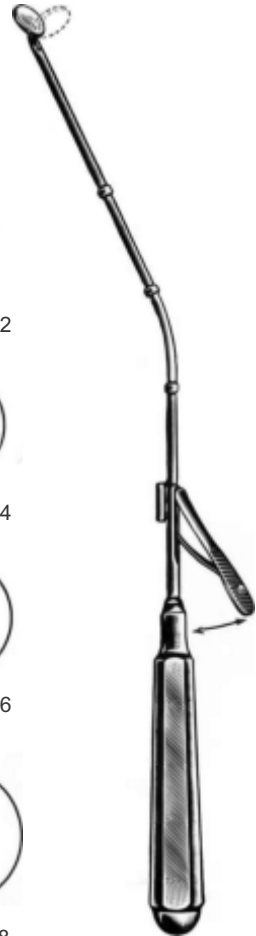

MICHEL  
27 cm / 10 3/4"

- NF.14.01.06 fig. 000 - Ø 6 mm
- NF.14.01.08 fig. 00 - Ø 8 mm
- NF.14.01.10 fig. 0 - Ø 10 mm
- NF.14.01.12 fig. 1 - Ø 12 mm
- NF.14.01.14 fig. 2 - Ø 14 mm
- NF.14.01.16 fig. 3 - Ø 16 mm
- NF.14.01.18 fig. 4 - Ø 18 mm
- NF.14.01.20 fig. 5 - Ø 20 mm
- NF.14.01.22 fig. 6 - Ø 22 mm
- NF.14.01.24 fig. 7 - Ø 24 mm
- NF.14.01.26 fig. 8 - Ø 26 mm
- NF.14.01.28 fig. 9 - Ø 28 mm
- NF.14.01.30 fig. 10 - Ø 30 mm

- NF.14.03.06 fig. 000 - Ø 6 mm
- NF.14.03.08 fig. 00 - Ø 8 mm
- NF.14.03.10 fig. 0 - Ø 10 mm
- NF.14.03.12 fig. 1 - Ø 12 mm
- NF.14.03.14 fig. 2 - Ø 14 mm
- NF.14.03.16 fig. 3 - Ø 16 mm
- NF.14.03.18 fig. 4 - Ø 18 mm
- NF.14.03.20 fig. 5 - Ø 20 mm
- NF.14.03.22 fig. 6 - Ø 22 mm
- NF.14.03.24 fig. 7 - Ø 24 mm
- NF.14.03.26 fig. 8 - Ø 26 mm
- NF.14.03.28 fig. 9 - Ø 28 mm
- NF.14.03.30 fig. 10 - Ø 30 mm

Shaft 10 cm long (4")

# Mouth & Throat Instruments

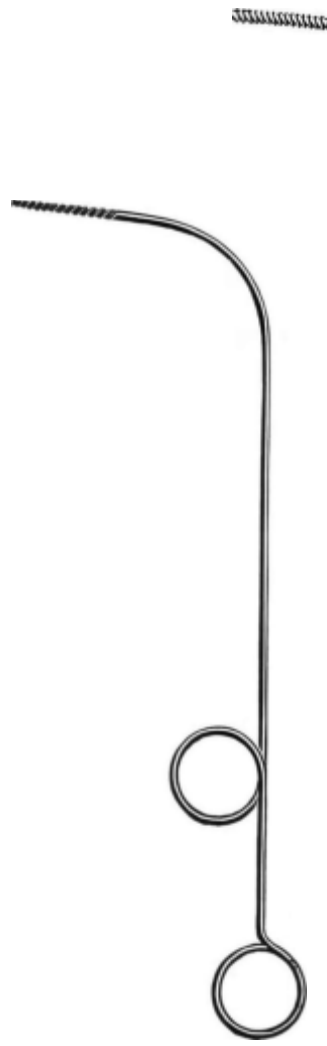

PELTSESON  
NF.14.04.30  
23.5 cm/ 9¼"



FEIN  
NF.14.04.35  
29 cm/ 11¾"



REICHERT  
NF.14.04.45  
23 cm/ 9"

# Mouth & Throat Instruments



HARTMANN  
NF.14.04.52  
20.5 cm/ 8 $\frac{1}{8}$ "



SAWTELL(TOBOLD)  
NF.14.04.60  
30 cm/ 11 $\frac{3}{4}$ "



KILLIAN  
NF.14.04.65  
25 cm/ 10"

# Mouth & Throat Instruments



NF.14.05.11  
NF.14.05.31  
# 1 - 10mm



NF.14.05.12  
NF.14.05.32  
# 2 - 11mm



NF.14.05.13  
NF.14.05.33  
# 3 - 12mm



NF.14.05.14  
NF.14.05.34  
# 4 - 13mm



NF.14.05.15  
NF.14.05.35  
# 5 - 15mm



NF.14.05.16  
NF.14.05.36  
# 6 - 16mm

with basket



BECKMANN  
NF.14.05.11 # 1  
NF.14.05.12 # 2  
NF.14.05.13 # 3  
NF.14.05.14 # 4  
NF.14.05.15 # 5  
NF.14.05.16 # 6  
22 cm/ 8<sup>3</sup>/<sub>4</sub>"

BECKMANN  
NF.14.05.31 # 1  
NF.14.05.32 # 2  
NF.14.05.33 # 3  
NF.14.05.34 # 4  
NF.14.05.35 # 5  
NF.14.05.36 # 6  
22 cm/ 8<sup>3</sup>/<sub>4</sub>"

# Mouth & Throat Instruments



SHAMBAUGH  
(NEGUS)  
NF.14.05.40 # 0  
NF.14.05.41 # 1  
NF.14.05.42 # 2  
NF.14.05.44 # 3  
NF.14.05.46 # 4  
NF.14.05.48 # 5  
22 cm/ 8¾"



NF.14.05.40 - 10 mm  
NF.14.05.60 - 14 mm  
# 0



NF.14.05.41 - 11 mm  
NF.14.05.61 - 16 mm  
# 1

with basket



NF.14.05.42 - 12 mm  
NF.14.05.62 - 18 mm  
# 2



NF.14.05.44 - 14 mm  
NF.14.05.64 - 20 mm  
# 3



NF.14.05.46 - 16 mm  
NF.14.05.66 - 22 mm  
# 4



NF.14.05.48 - 18 mm  
NF.14.05.68 - 24 mm  
# 5

Curved backward

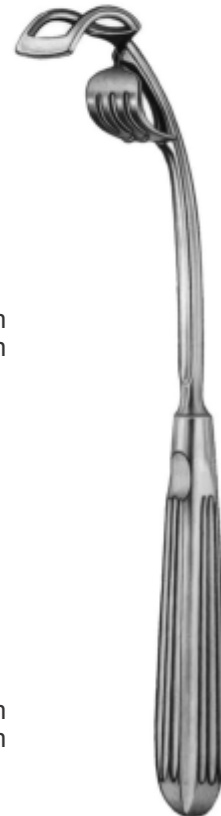

SHAMBAUGH  
(NEGUS)  
NF.14.05.60 # 0  
NF.14.05.61 # 1  
NF.14.05.62 # 2  
NF.14.05.64 # 3  
NF.14.05.66 # 4  
NF.14.05.68 # 5  
21 cm/ 8¼"

# Mouth & Throat Instruments

Included in the consignment: 3 blades of the each size



Replacement blades only for la force and shambaugh adenotome

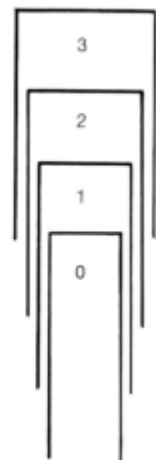

LA FORCE-MEDICON  
NF.14.06.10 # 0  
NF.14.06.11 # 1  
NF.14.06.12 # 2  
NF.14.06.13 # 3  
23.5 cm/ 9¼"

SHAMBAUGH  
NF.14.06.50 # 0  
NF.14.06.51 # 1  
NF.14.06.52 # 2  
NF.14.06.53 # 3  
23.5 cm/ 9¼"

NF.14.06.90 # 0 - 10 mm  
NF.14.06.91 # 1 - 13 mm  
NF.14.06.92 # 2 - 16 mm  
NF.14.06.93 # 3 - 19 mm

# Mouth & Throat Instruments

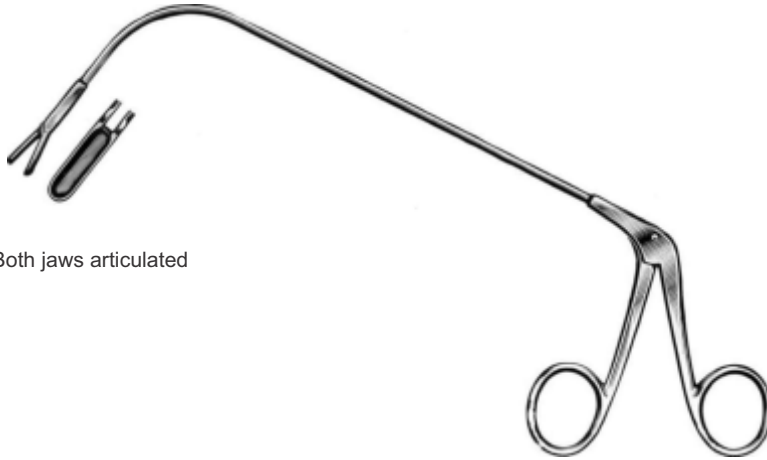

Both jaws articulated

FRANKEL  
NF.14.07.17

Working length 17 cm (6 ¾")

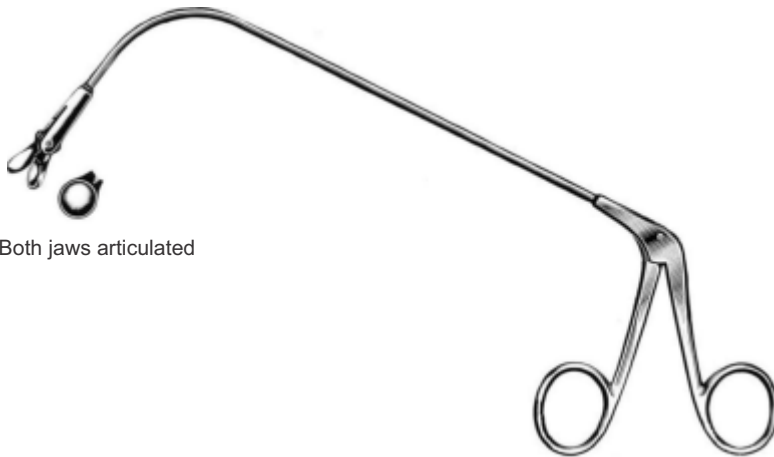

Both jaws articulated

LANGE  
NF.14.08.17

Working length 17 cm (6 ¾")

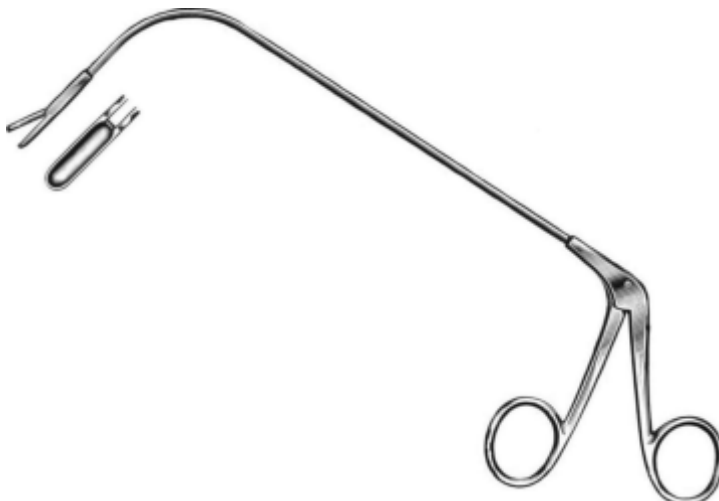

JURASZ  
NF.14.10.24  
NF.14.10.25  
NF.14.10.26  
NF.14.10.27

Working length 17 cm (6 ¾")

NF.14.10.26  
Opening upward

NF.14.10.27  
opening downward

NF.14.10.24  
Opening right

NF.14.10.25  
Opening left

# Mouth & Throat Instruments



sharp

ST. CLAIR-THOMSON  
NF.14.09.38  
18 cm / 7 1/8"

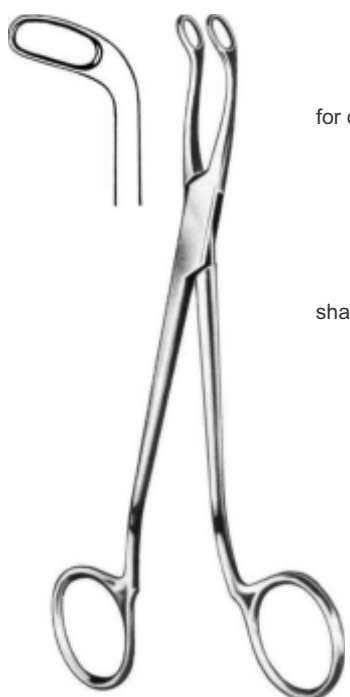

for children

sharp

JURASZ  
NF.14.09.39  
19 cm / 7 1/2"

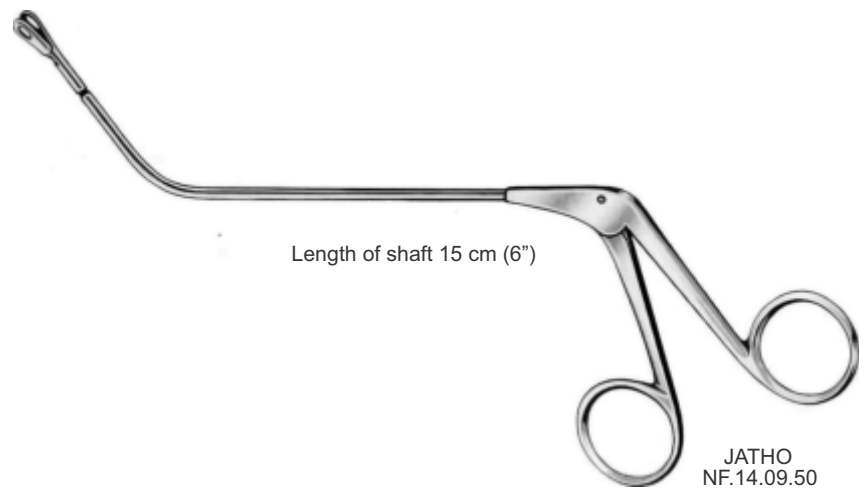

Length of shaft 15 cm (6")

JATHO  
NF.14.09.50



# Mouth & Throat Instruments



Micro laryngeal surgery

Shaft 2 mmø



NF.14.10.31  
serrated jaws, straight



NF.14.10.32  
serrated jaws right



NF.14.10.36  
round cup jaws, straight



NF.14.10.41  
serrated jaws left



NF.14.10.33  
round cup jaws, up



NF.14.10.37  
round cup jaws, left



NF.14.10.42  
round cup jaws, right



NF.14.10.34  
oval cup jaws, straight



NF.14.10.38  
oval cup jaws, right



NF.14.10.43  
oval cup jaws, up



NF.14.10.35  
oval cup jaws, left



NF.14.10.39  
jaw fenestrated



NF.14.10.44  
oval cup jaws, straight

# Mouth & Throat Instruments



NF.14.10.50  
straight



NF.14.10.51  
angled up



NF.14.10.52  
Curved to right



NF.14.10.53  
curved to left



NF.14.10.54  
angled down



NF.14.10.55  
straight, horizontally cutting

Flexible working end

Naso-Pharyngeal Forceps

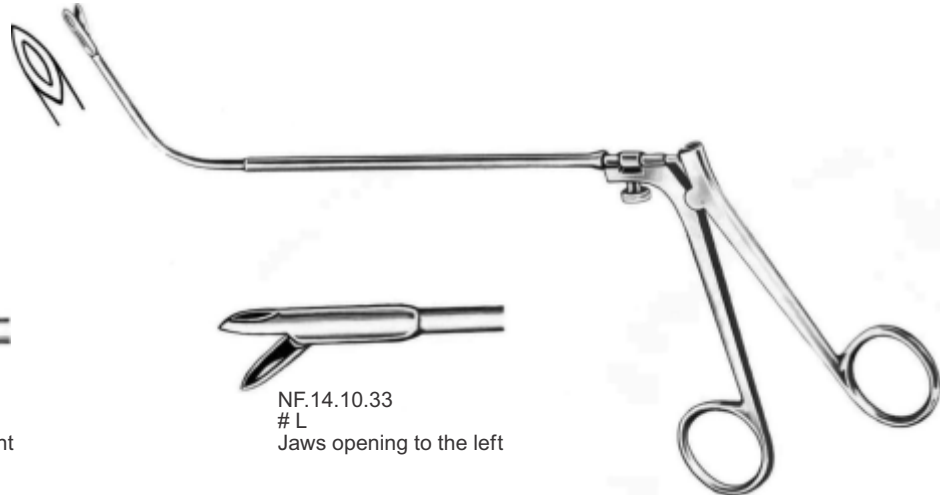

NF.14.10.32  
# R  
Jaws opening to the right



NF.14.10.33  
# L  
Jaws opening to the left

NF.14.10.32 # R  
NF.14.10.33 # L

# Mouth & Throat Instruments

## Uvule retractors



LOVE  
15 cm/ 6"  
NF.14.10.48 18 mm  
NF.14.10.50 20mm  
NF.14.10.52 22 mm

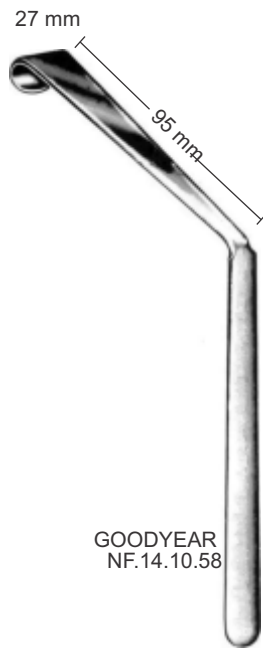

GOODYEAR  
NF.14.10.58



LOTHROP  
NF.14.10.60

## 13 mm soft palate retractor

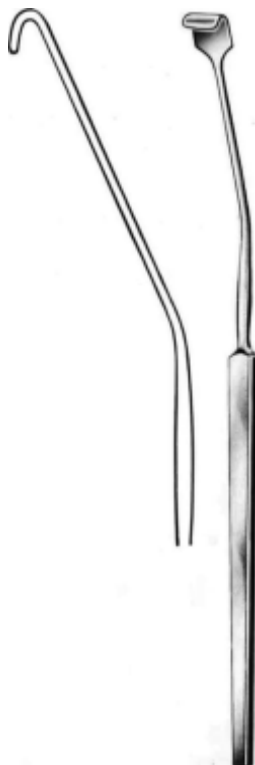

NAGER  
NF.14.10.72  
22 cm/ 8¾"

## 20 x 20 mm palate arch retractor



HOFER  
NF.14.10.74  
24 cm/ 9½"

# Mouth & Throat Instruments

Elongation tubes      rigid      angled

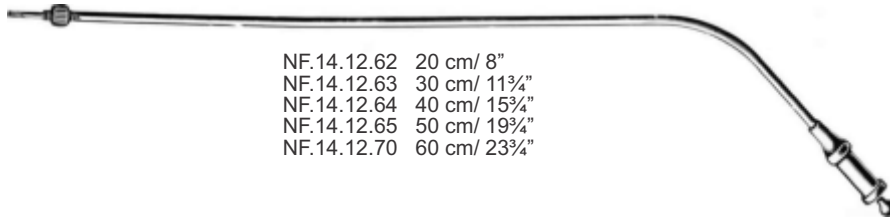

- NF.14.12.62 20 cm/ 8"
- NF.14.12.63 30 cm/ 11 $\frac{3}{4}$ "
- NF.14.12.64 40 cm/ 15 $\frac{3}{4}$ "
- NF.14.12.65 50 cm/ 19 $\frac{3}{4}$ "
- NF.14.12.70 60 cm/ 23 $\frac{3}{4}$ "

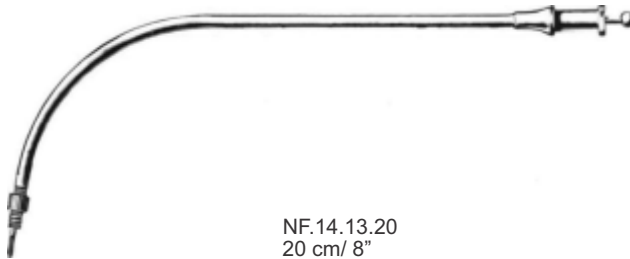

NF.14.13.20  
20 cm/ 8"

Elongation tubes      curved

# Mouth & Throat Instruments

Laryngeal forceps tips (suitable for elongation tubes)



FRANKEL  
NF.14.14.05



FRANKEL  
NF.14.15.03



FRANKEL  
NF.14.16.01



BRUNINGS  
NF.14.14.13 Ø 3 mm  
NF.14.14.14 Ø 4 mm



EICKEN  
NF.14.15.08



SEIFFERT  
NF.14.16.06



FRANKEL  
NF.14.14.20



BRUNINGS  
NF.14.15.13 Ø 3 mm  
NF.14.15.14 Ø 4 mm



LANGE  
NF.14.16.15



KRAUSE  
NF.14.14.31



SCHEINMANN  
NF.14.15.27



BRUNINGS  
NF.14.16.22 2.5 X 5 mm  
NF.14.16.23 3 X 6 mm



SCHEINMANN  
NF.14.14.37



KRAUSE  
NF.14.15.35



KRAUSE  
NF.14.16.34



SCHUMACHER  
NF.14.16.40

# Mouth & Throat Instruments



JACKSON  
NF.14.10.68  
18.5 cm / 7¼"

Laryngeal Forceps



KILLIAN  
NF.14.10.70  
20 cm / 8"

Laryngectomy scissors



Medicon Universal handle for elongation tubes

MEDICON-UNIVERSAL  
NF.14.11.45

Elongation tubes      rigid      straight



NF.14.12.20 20 cm/ 8"  
NF.14.12.30 30 cm/ 11<sup>3</sup>/<sub>4</sub>"  
NF.14.12.40 40 cm/ 15<sup>3</sup>/<sub>4</sub>"  
NF.14.12.50 50 cm/ 19<sup>3</sup>/<sub>4</sub>"  
NF.14.12.60 60 cm/ 23<sup>3</sup>/<sub>4</sub>"

# Mouth & Throat Instruments

Laryngeal forceps tips (suitable for elongation tubes)



**CORDES (ROSENBERG)**  
NF.14.17.61 # 1-3 mm  
NF.14.17.62 # 2-4 mm  
NF.14.17.63 # 3-5 mm



**CORDES**  
NF.14.18.51  
Ø 4 mm



**CORDES**  
NF.14.19.50  
Ø 4 mm



**CORDES**  
NF.14.17.71 # 1  
NF.14.17.72 # 2



**CORDES**  
NF.14.18.70  
5 mm

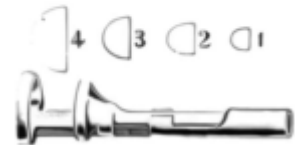

**CORDES**  
NF.14.19.61 # 1-3 mm  
NF.14.19.62 # 2-4 mm  
NF.14.19.63 # 3-5 mm  
NF.14.19.64 # 4-8 mm



**CORDES**  
NF.14.19.76



**EICKEN**  
NF.14.17.78



**SEIFFERT**  
NF.14.18.76



**FRANKEL**  
NF.14.19.81



**BRUNINGS**  
NF.14.17.82 2.5 X 5 mm  
NF.14.17.83 3 X 6 mm



**FRANKEL**  
NF.14.18.80



**BRUNINGS**  
NF.14.19.83 Ø 3 mm  
NF.14.19.84 Ø 4 mm



**KRAUSE**  
NF.14.18.84  
NF.14.18.85

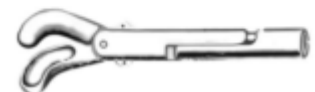

**SCHEINMANN**  
NF.14.19.97



# Mouth & Throat Instruments

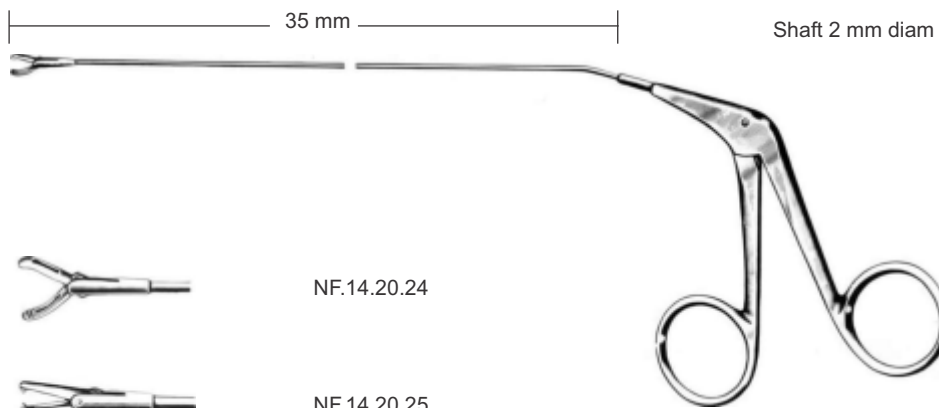
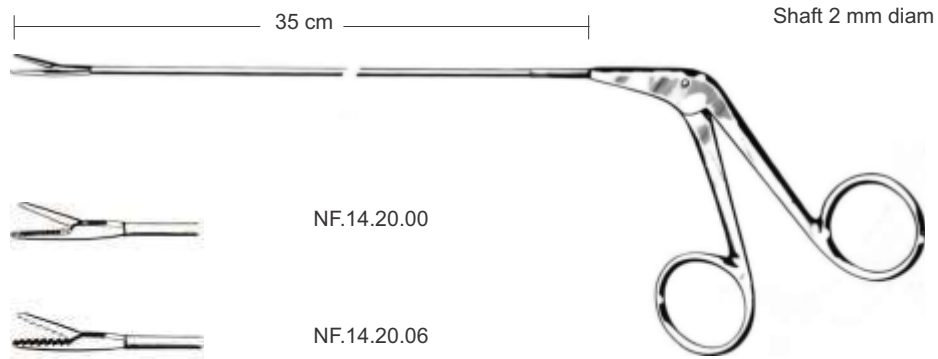

MEDICON-JACKSON  
Delicate pattern

# Mouth & Throat Instruments

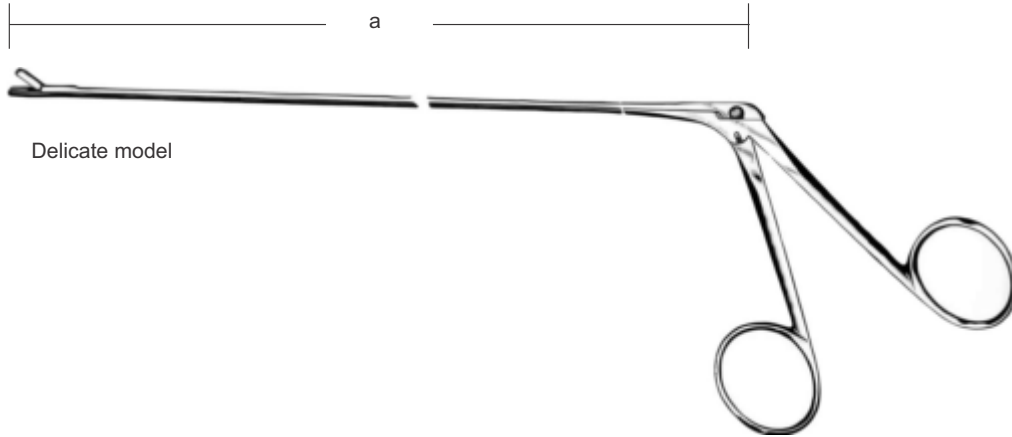

Delicate model

			Ø 2 mm	Ø 2 mm
a				
28 cm	NF.14.21.04	NF.14.21.12	NF.14.21.17	
35 cm	NF.14.22.04	NF.14.22.12	NF.14.22.17	

	PATTERSON		
a			
28 cm	NF.14.23.20	NF.14.23.31	NF.14.23.35
35 cm	NF.14.24.20	NF.14.24.31	NF.14.24.35

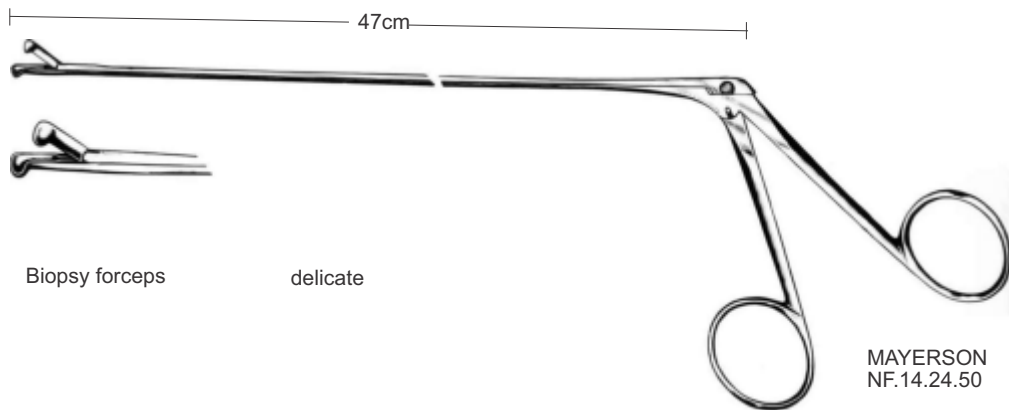

Biopsy forceps

delicate

MAYERSON  
NF.14.24.50

# Mouth & Throat Instruments

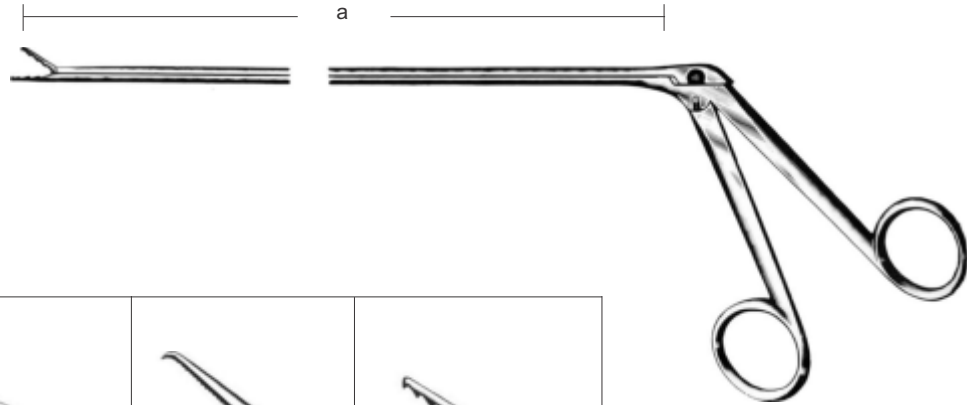

JACKSON



a			
30 cm	NF.15.25.04	NF.15.25.05	NF.15.25.06
40 cm	NF.15.26.04	NF.15.26.05	NF.15.26.06
50 cm	NF.15.27.04	NF.15.27.05	NF.15.27.06
60 cm	NF.15.28.04	NF.15.28.05	NF.15.28.06

a				
	Ø 2 mm	Ø 4 mm	Ø 2 mm	Ø 4 mm
30 cm	NF.15.30.12	NF.15.30.14	NF.15.30.17	NF.15.30.19
40 cm	NF.15.31.12	NF.15.31.14	NF.15.31.17	NF.15.31.19
50 cm	NF.15.32.12	NF.15.32.14	NF.15.32.17	NF.15.32.19
60 cm	NF.15.33.12	NF.15.33.14	NF.15.33.17	NF.15.33.19

a			
	11 x 4 mm PATTERSON		
30 cm	NF.15.35.20	NF.15.35.31	NF.15.35.35
40 cm	NF.15.36.20	NF.15.36.31	NF.15.36.35
50 cm	NF.15.37.20	NF.15.37.31	NF.15.37.35
60 cm	NF.15.38.20	NF.15.38.31	NF.15.38.35

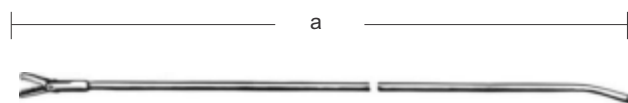
# Mouth & Throat Instruments





a		
35 cm	NF.15.40.06	NF.15.40.08
45 cm	NF.15.41.06	NF.15.41.08
55 cm	NF.15.42.06	NF.15.42.08



MEDICON JACKSON

Shaft 3mm diam, for use through tubes up from 6 mm diam

a		
35 cm	NF.15.45.25	NF.15.45.28
45 cm	NF.15.46.25	NF.15.46.28
55 cm	NF.15.47.25	NF.15.47.28

a		
35 cm	NF.15.50.31	NF.15.50.35
45 cm	NF.15.51.31	NF.15.51.35
55 cm	NF.15.52.31	NF.15.52.35

a	
35 cm	NF.15.55.45
45 cm	NF.15.56.45
55 cm	NF.15.57.45

# Mouth & Throat Instruments

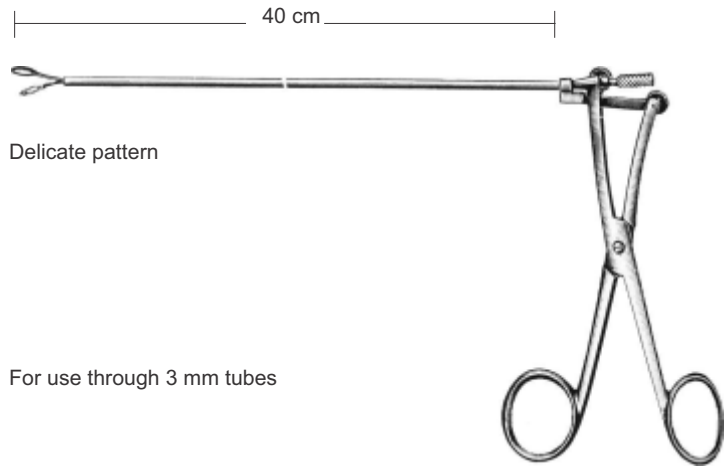

ORIGINAL-JACKSON  
40 cm/ 16"  
Ø 3 mm

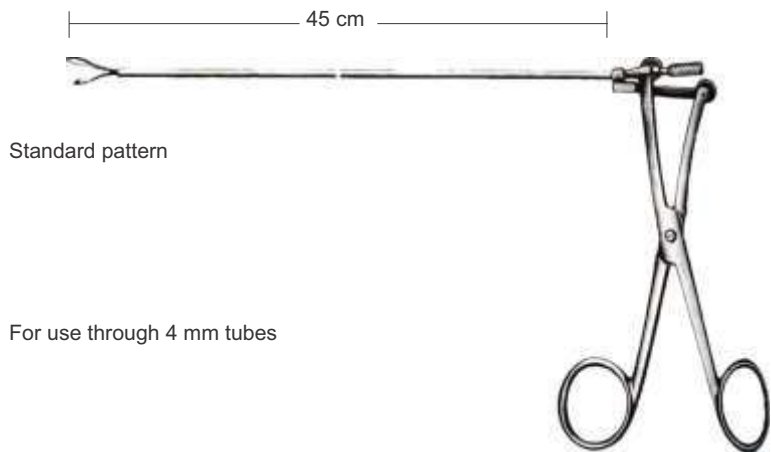

ORIGINAL-JACKSON  
45 cm/ 17<sup>3</sup>/<sub>4</sub>"  
Ø 4 mm

# Mouth & Throat Instruments

German silver

Silver plated



### CHEVALIER-JACKSON

NF.15.33.50	Fig. 0 - 4 mm Ø	NF.15.33.60
NF.15.33.51	Fig. 1 - 5 mm Ø	NF.15.33.61
NF.15.33.52	Fig. 2 - 6 mm Ø	NF.15.33.62
NF.15.33.53	Fig. 3 - 7 mm Ø	NF.15.33.63
NF.15.33.54	Fig. 4 - 8 mm Ø	NF.15.33.64
NF.15.33.55	Fig. 5 - 9 mm Ø	NF.15.33.65
NF.15.33.56	Fig. 6 - 10 mm Ø	NF.15.33.66
NF.15.33.57	Fig. 7 - 11 mm Ø	NF.15.33.67
NF.15.33.58	Fig. 8 - 12 mm Ø	NF.15.33.68
NF.15.33.59	Fig. 9 - 13 mm Ø	NF.15.33.69

Speaking tube

Silver plated



### LUER











NF.15.34.08	Fig. 4 - 8 mm Ø
NF.15.34.09	Fig. 5 - 9 mm Ø
NF.15.34.10	Fig. 6 - 10 mm Ø
NF.15.34.11	Fig. 7 - 11 mm Ø
NF.15.34.12	Fig. 8 - 12 mm Ø
NF.15.34.13	Fig. 9 - 13 mm Ø

Cleaning brush for tracheal tubes

NF.15.34.20  
19.5 cm/ 7¾"  
Ø 11 mm



International scale of tracheal tube sizes

										
Fig.	0	1	2	3	4	5	6	7	8	9
mm Ø	4	5	6	7	8	9	10	11	12	13
Charr.	12	15	18	21	24	27	30	33	36	39
Length mm	45	50	55	60	65	70	75	80	85	90

Tracheal tube, standard pattern



German silver

LUER

Silver plated

NF.15.33.80	Fig. 0 - 4 mm Ø	NF.15.33.90
NF.15.33.81	Fig. 1 - 5 mm Ø	NF.15.33.91
NF.15.33.82	Fig. 2 - 6 mm Ø	NF.15.33.92
NF.15.33.83	Fig. 3 - 7 mm Ø	NF.15.33.93
NF.15.33.84	Fig. 4 - 8 mm Ø	NF.15.33.94
NF.15.33.85	Fig. 5 - 9 mm Ø	NF.15.33.95
NF.15.33.86	Fig. 6 - 10 mm Ø	NF.15.33.96
NF.15.33.87	Fig. 7 - 11 mm Ø	NF.15.33.97
NF.15.33.88	Fig. 8 - 12 mm Ø	NF.15.33.98
NF.15.33.89	Fig. 9 - 13 mm Ø	NF.15.33.99

# Mouth & Throat Instruments



BOSE  
NF.15.37.07  
7 cm / 2¾"

Tracheal dilators



TROUSSEAU  
NF.15.36.12  
12 cm / 4¾"

for children

TROUSSEAU  
NF.15.36.14  
14 cm / 5½"

for adults

Tracheal artery forceps



JACKSON  
NF.15.36.15  
14.5 cm / 5¾"

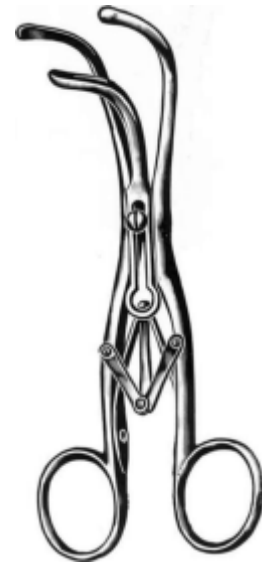

LABORDE  
NF.15.37.15  
15 cm / 6"

for adults

LABORDE  
NF.15.37.13  
13 cm / 5½"

for children



## Tracheal retractors



BOSE  
NF.15.37.32  
16 cm/ 6¼"



BOSE  
NF.15.37.33  
16 cm/ 6¼"

## Tracheotomy trocars



NF.15.37.45  
16 cm/ 6¼"  
Ø 3 mm  
for infants



UECKERMANN-  
DENKER  
NF.15.37.50  
Ø 10 mm  
13 cm/ 5⅛"  
Sterling silver

## Tracheotomy knife



JACKSON  
NF.15.41.16  
17 cm/ 6¾"

# Mouth & Throat Instruments



JACKSON  
NF.15.38.13  
13 cm/ 5 1/8"



LUCKENS  
NF.15.39.13

Thyroid dissector

10mm  
wide



KOCHER  
NF.15.43.15  
15 cm/ 6"

Thyroid dissecting scissors

12mm  
wide



KOCHER  
NF.15.43.16  
16.5 cm/ 6 1/2"

SCHOEMAKER  
NF.15.43.25  
15 cm/ 6"

Goiter forceps

sharp



LOVELACE  
NF.15.43.35  
15 cm/ 6"

sharp



LAHEY  
NF.15.43.45  
15 cm/ 6"

# Mouth & Throat Instruments

Automatic adjusting ratchet

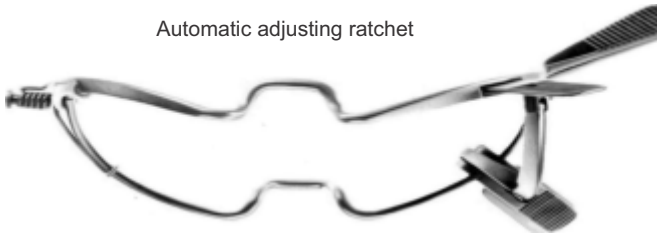

**PROFESSIONAL**  
NF.15.01.49 9 cm/ 3½"  
NF.15.01.51 11 cm/ 4¼"  
NF.15.01.53 13 cm/ 5⅛"  
NF.15.01.55 15 cm/ 6"

**SEEMANN-SEIFFERT**  
NF.15.02.61 11 cm/ 4¼"  
NF.15.02.63 13 cm/ 5⅛"

Dimensions = effective width



**JENNINGS  
PROFESSIONAL**  
NF.15.03.30



**JENNINGS**  
NF.15.09.09 9 cm/ 3½"  
NF.15.09.11 11 cm/ 4¼"  
NF.15.09.13 13 cm/ 5⅛"  
NF.15.09.15 15 cm/ 6"



**WHITEHEAD**  
NF.15.11.29 9 cm/ 3½"  
NF.15.11.31 11 cm/ 4¼"  
NF.15.11.33 13 cm/ 5⅛"  
NF.15.11.35 15 cm/ 6"

# Mouth & Throat Instruments

## Mouth gags

of wood



NF.15.04.10  
Ø 40 mm

of hard rubber



NF.15.04.20  
Ø 40 mm



HEISTER  
NF.15.05.05  
13 cm/ 5 1/8"

for children



MOLT  
NF.15.06.10  
10 cm/ 4"

for adults



MOLT  
NF.15.07.15  
15 cm/ 6"

Soft metal coated



DOYEN-JANSEN  
NF.15.08.20 10 cm/ 4"  
NF.15.08.25 15 cm/ 6"

NF.15.08.20  
for children

NF.15.08.25  
for adults



ROSER KÖNING  
NF.15.13.45  
16 cm/ 6 1/4"

# Mouth & Throat Instruments

Mouth openers

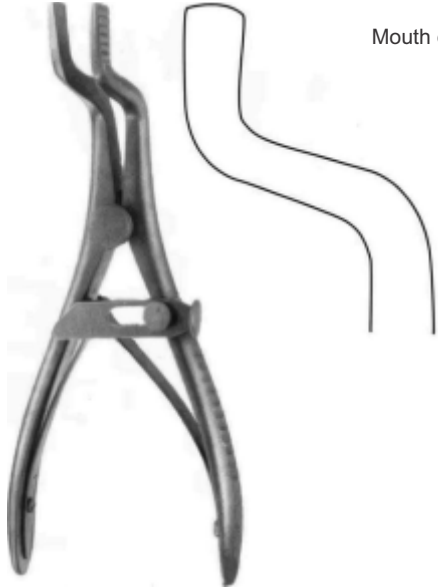

OBWEGESER-ROSER  
NF.15.13.46  
16 cm/ 6¼"



OBWEGESER  
NF.15.13.53  
12.5 cm/ 5"



DENHART  
NF.15.14.60  
13 cm/ 5½"



FERGUSSON-ACKLAND  
NF.15.15.70  
20 cm/ 8"



NF.15.16.80  
for children

NF.15.16.81  
for adults

MASON-ACKLAND  
NF.15.16.80 14 cm/ 5½"  
NF.15.16.81 20 cm/ 8"

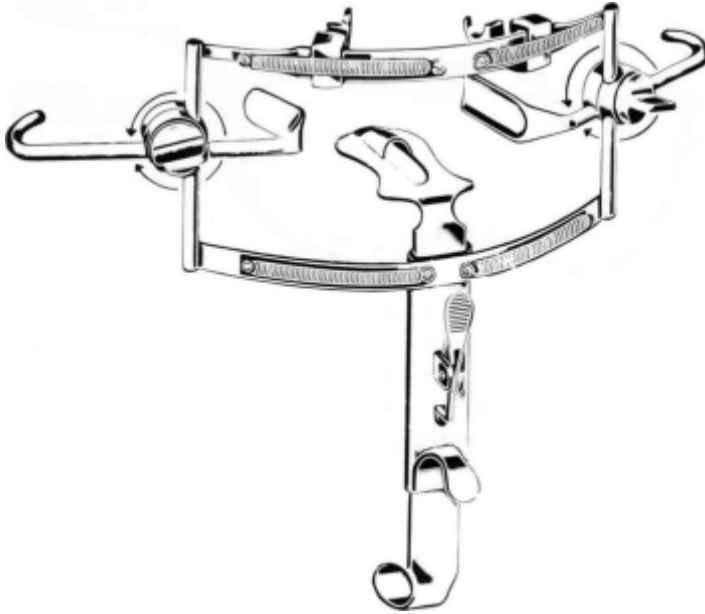

DINGMAN  
NF.15.18.00



NF.15.18.11  
# 1  
55 x 25 mm



NF.15.18.12  
# 2  
60 x 27 mm



NF.15.18.13  
# 3  
70 x 30 mm

NF.15.18.00

Dingman mouth gag, complete consisting of: frame with 2 tooth hooks, 2 lateral cheek retractors and 3 Tongue depressors (1 each figures 1 to 3 )

-----  
Frame only for the DINGMAN mouth gag, with 4 spiral spring for the suspension of the thread ends, 2 movable tooth hooks and 2 movable cheek retractors

# Mouth & Throat Instruments

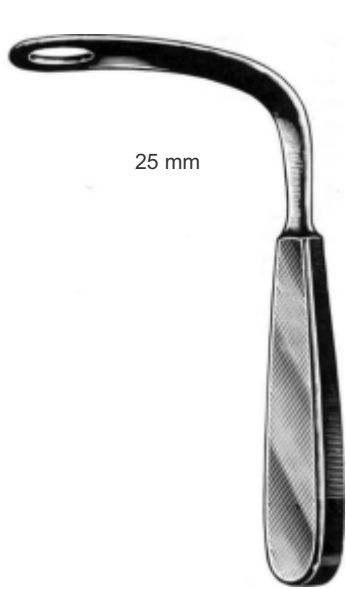

BOSWORTH  
NF.15.01.20



TOBOLD  
NF.15.01.14

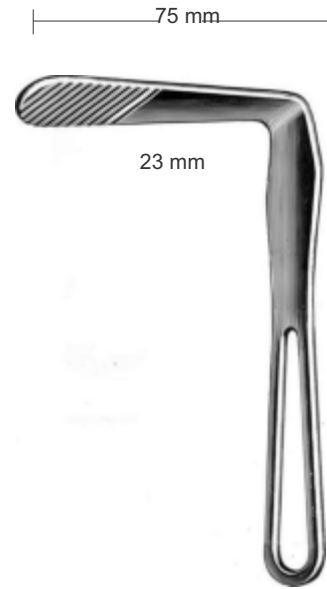

HARTMANN  
NF.15.02.15

## Tongue Depressors



ANDREWS  
NF.15.02.30



WIEDER

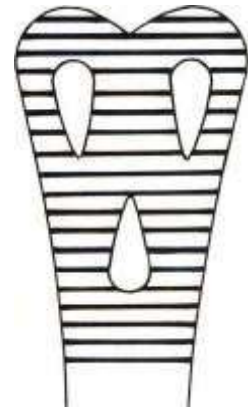

NF.15.02.21  
28 mm

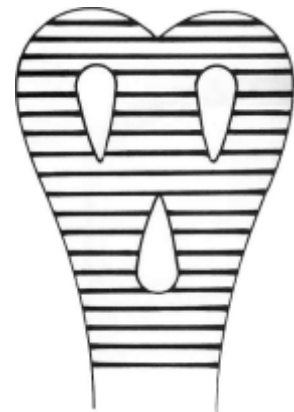

NF.15.02.22  
38 mm

# Mouth & Throat Instruments

18 mm



NF.15.03.12  
14.5 cm / 5 3/4"

20 mm



NF.15.03.14  
14 cm / 5 1/2"

23 mm



STERNBERG  
NF.15.03.15  
14.5 cm / 5 3/4"

wood



NF.15.03.16  
16 cm / 6 1/4"

Package unit 100 pieces

18 mm



BAGINSKI  
NF.15.03.25  
15 cm / 6"

35 mm

Tongue Depressors



UNIV. MINNESOTA  
NF.15.03.34  
14 cm / 5 1/2"

23 mm



13 mm

FRENZEL  
NF.15.03.35  
16.5 cm / 6 1/2"

18 mm



BUCHWALD  
NF.15.04.18  
18 cm / 7 1/8"

23 mm



# Mouth & Throat Instruments



NF.15.04.22 22+29 mm  
NF.15.04.26 30+33 mm

HASLINGER  
NF.15.04.22 12 cm/ 4¾"  
NF.15.04.26 16 cm/ 6¼"



18 mm

14 mm

BRUNINGS  
NF.15.05.18  
19 cm/ 7½"



MORITZ-SCHMIDT  
NF.15.05.19  
19 cm/ 7½"



NF.15.06.21  
#1, Ø 17 - 21 mm



NF.15.06.24  
#2, Ø 19 - 24 mm



NF.15.06.26  
#3, Ø 21 - 26 mm

# Nasal Instruments



# Nasal Instruments

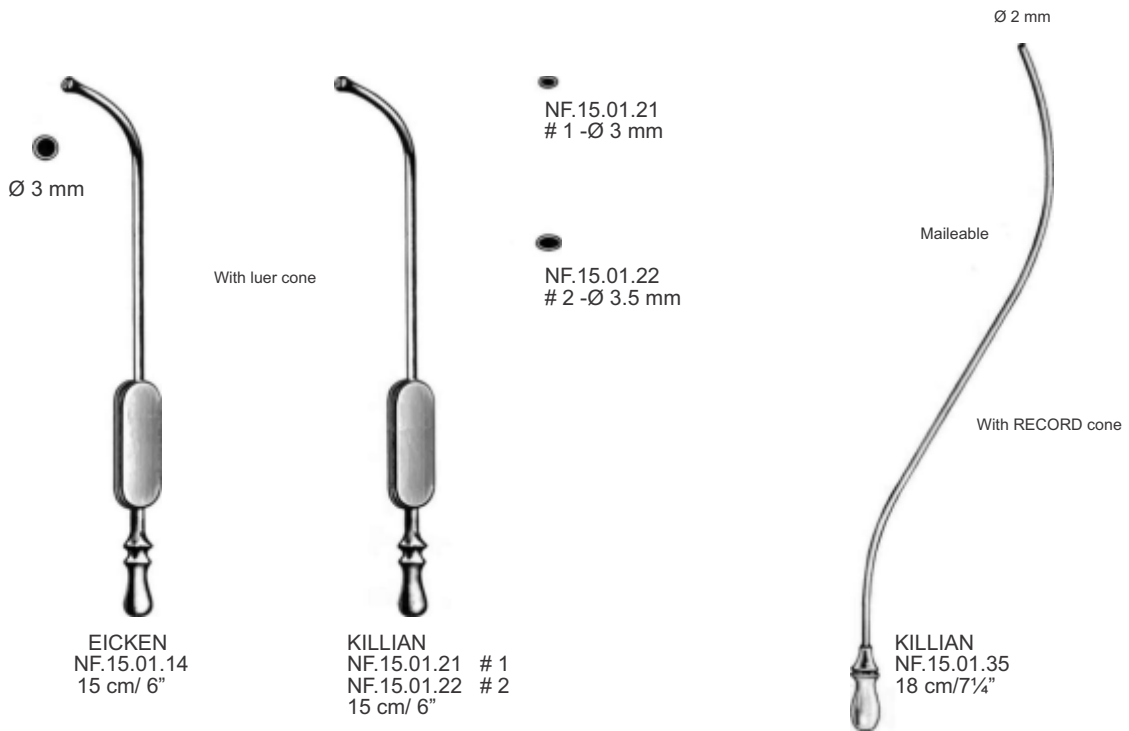

# 1 - Ø 1.5 mm

# 2 - Ø 1.5 mm



VAN ALYEA  
NF.15.02.45  
12 cm/ 4¾"

LUER-LOCK



VAN ALYEA  
NF.15.02.46  
12 cm/ 4¾"

# Nasal Instruments

# 1 - Ø 2 mm



VAN ALYEA  
NF.15.02.51  
15 cm / 6"

# 2 - Ø 2 mm



VAN ALYEA  
NF.15.02.52  
15 cm / 6"

Irrigating Tube for frontal sinus

Sterling Silver

With luer cone



SIEBENMANN  
NF.15.02.25 Ø 2.5 mm  
NF.15.02.30 Ø 3.0 mm  
13cm / 5¼"

Ø 2.5 mm



Ø 3.0 mm



SIEBENMANN  
NF.15.02.55 Ø 2.5 mm  
NF.15.02.80 Ø 3.0 mm  
13cm / 5¼"

# Nasal Instruments

## Irrigating Tubes

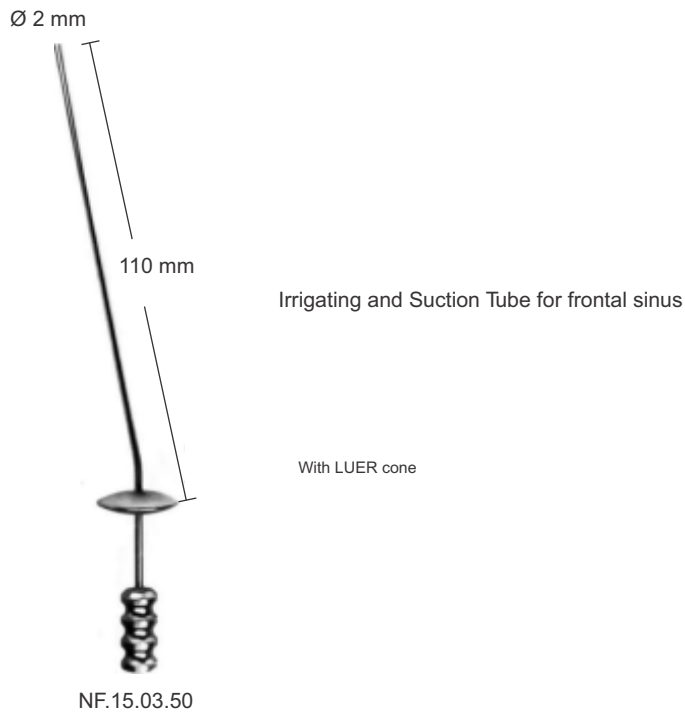
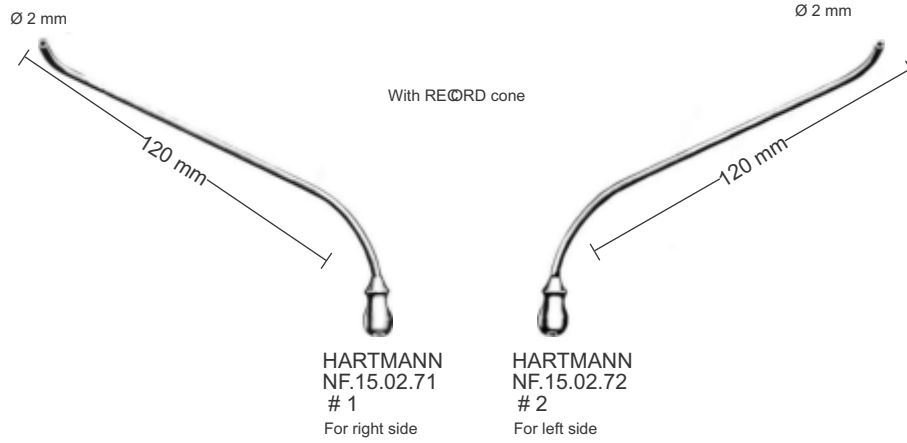

# Nasal Instruments



WIENER  
18 cm/ 7¼"



Antrum Rasps



Frontal Sinus Bougies

RITTER-HALLE  
NF.15.04.42 Ø 2.5 mm  
NF.15.04.43 Ø 3.0 mm  
NF.15.04.44 Ø 4.0 mm  
16 cm/ 6¼"

30 X 10 mm



Serrated

Antrum Retractor

BRUENINGS-BRUNK  
NF.15.04.50  
19 cm/ 7½"

# Nasal Instruments



KRAUSE  
NF.15.07.25  
25 cm/ 10"



KRAUSE/VOSS  
NF.15.07.30  
25 cm/ 10"



WILDE (BRUENINGS)  
NF.15.08.24  
25 cm/ 10"

## Snare Wire



NF.15.07.40  
0.3 mm

Package / 100



NF.15.07.43 0.35 mm  
NF.15.07.44 0.40 mm  
NF.15.07.45 0.45 mm

Coil/10 meters

# Nasal Instruments



delicate pattern

HARTMANN  
NF.15.04.16  
16 cm/ 6¼"



standard pattern

HARTMANN  
NF.15.05.18  
20 cm/ 8"

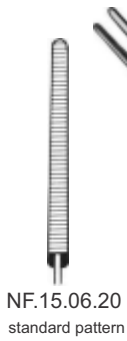

WESTMACOTT  
20 cm/ 8"

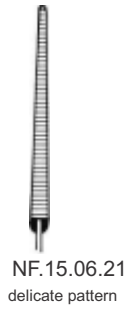

LUBET-BARBON  
NF.15.06.30  
20 cm/ 8"



# Nasal Instruments



NOYEN  
NF.15.07.30



NOYEN  
NF.15.07.31



TILLEY  
NF.15.07.35  
17 cm/ 6 3/4"

# Nasal Instruments



for infants

**BECKMANN**  
NF.15.08.04  
13 cm / 5 1/8"



**HARTMANN**  
15 cm / 6"



NF.15.08.15  
# 1



NF.15.08.16  
# 2



NF.15.08.17  
# 3



NF.15.09.11  
for infants

NF.15.09.10  
for babies

**TIECK-HALLE**  
13.5 cm / 5 3/4"

For COTTLE Septum Specula  
For Rhinoplasty

For COTTLE Speculums



**HARTMANN-HALLE**  
NF.15.10.15 # 1  
NF.15.10.16 # 2  
NF.15.10.17 # 3  
15 cm / 6"



NF.15.10.15  
NF.15.11.15  
# 1



NF.15.10.16  
NF.15.11.16  
# 2



NF.15.10.17  
NF.15.11.17  
# 3



aseptic joint  
(dismantable)

**HARTMANN-HALLE**  
NF.15.11.15 # 1  
NF.15.11.16 # 2  
NF.15.11.17 # 3  
15 cm / 6"

# Nasal Instruments

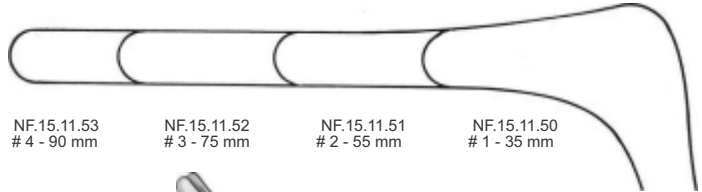

NF.15.11.53  
# 4 - 90 mm

NF.15.11.52  
# 3 - 75 mm

NF.15.11.51  
# 2 - 55 mm

NF.15.11.50  
# 1 - 35 mm



Nasal septum speculum



**COTTLE**  
NF.15.11.60  
14 cm/ 5½"

**COTTLE**  
NF.15.11.50 # 1  
NF.15.11.51 # 2  
NF.15.11.52 # 3  
NF.15.11.53 # 4  
14 cm/ 5½"

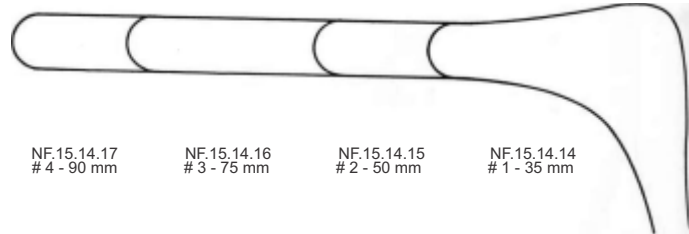

NF.15.14.17  
# 4 - 90 mm

NF.15.14.16  
# 3 - 75 mm

NF.15.14.15  
# 2 - 50 mm

NF.15.14.14  
# 1 - 35 mm



**BECKMANN**  
15 cm/ 6"



NF.15.13.15  
# 1



NF.15.13.16  
# 2



NF.15.13.17  
# 3



**KILLIAN**  
NF.15.14.14 # 1  
NF.15.14.15 # 2  
NF.15.14.16 # 3  
NF.15.14.17 # 4  
14 cm/ 5½"

# Nasal Instruments



"WIENER MODELL"  
15 cm / 6"



NF.15.15.14  
# 1

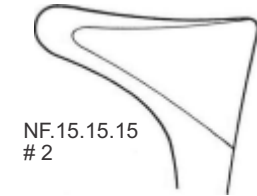

NF.15.15.15  
# 2

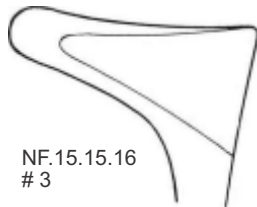

NF.15.15.16  
# 3

Economy Pattern



"WIENER MODELL  
STANDARD"  
15 cm / 6"



NF.15.16.15  
# 1



NF.15.16.16  
# 2



NF.15.16.17  
# 3



"WIENER MODELL"  
13 cm / 5 1/4"



NF.15.16.31  
# 1



NF.15.16.32  
# 2

Light pattern



NF.15.16.92  
14 cm / 5 1/2"



Economy, light- weight pattern

# Nasal Instruments



THUDILCHUM  
(GOLDSMITH)  
6.5 cm/ 2½"



NF.15.17.01  
# 1



NF.15.17.02  
# 2



NF.15.17.03  
# 3

Self-retaining



VOLTOLINI  
(DUPLAY)  
NF.15.17.11 #1  
NF.15.17.12 #2  
NF.15.17.13 #3

Self-retaining, spread adjustable by set screw

# Nasal Instruments

Serrated cutting blades

Angled to side



HEYMANN  
NF.15.17.18  
17 cm/ 6¾"

HEYMANN  
NF.15.17.19  
17 cm/ 6¾"

HEYMANN  
NF.15.17.20  
20 cm/ 8"

SEILER  
NF.15.17.46  
17 cm/ 6¾"



135 mm



Tubular shaft, lower cutting edge toothed



NF.15.18.24

For sinuscopy

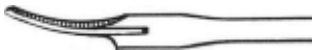

NF.15.18.25

For rhinoplasty scissors



NF.15.18.26

# Nasal Instruments

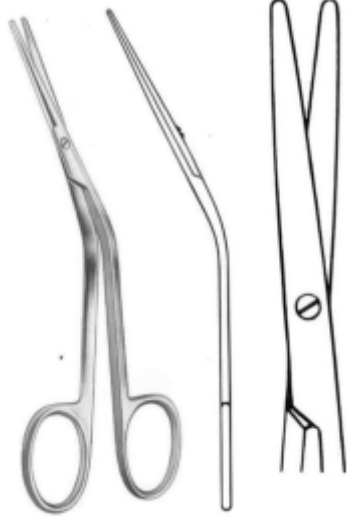

FOMON  
NF.15.50.13  
13 cm/ 5¼"



FOMON  
SUPERCUT  
NF.15.50.113  
13 cm/ 5 ¼"



FOMON  
SUPERCUT PLUS  
NF.15.50.163  
13 cm/ 5¼"



WALTER  
SUPERCUT  
NF.15.50.14  
14 cm/ 5½"

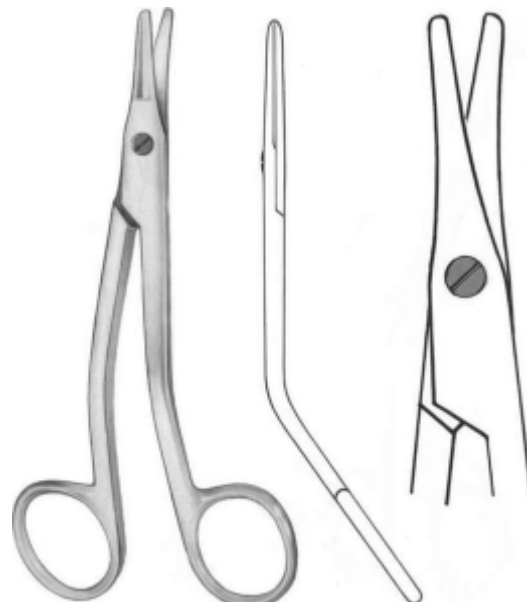

COTTLE-WALTER  
SUPERCUT  
NF.15.50.16  
16 cm/ 6¼"

# Nasal Instruments



COTTLE  
NF.15.51.16  
16 cm/ 6¼"

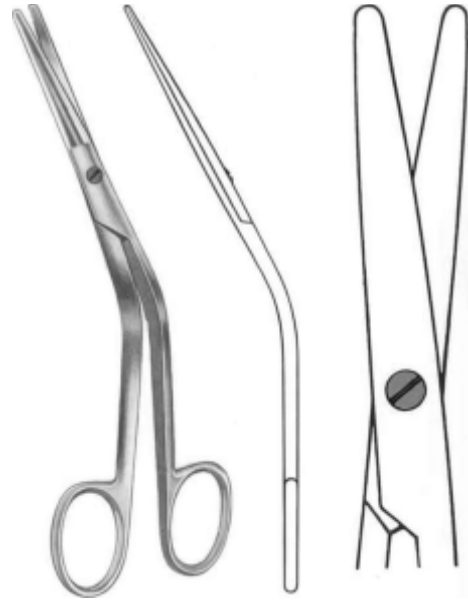

COTTLE  
SUPERCUT  
NF.15.51.116  
16 cm/ 6¼"



COTTLE  
"TC"  
NF.15.51.36  
16 cm/ 6¼"

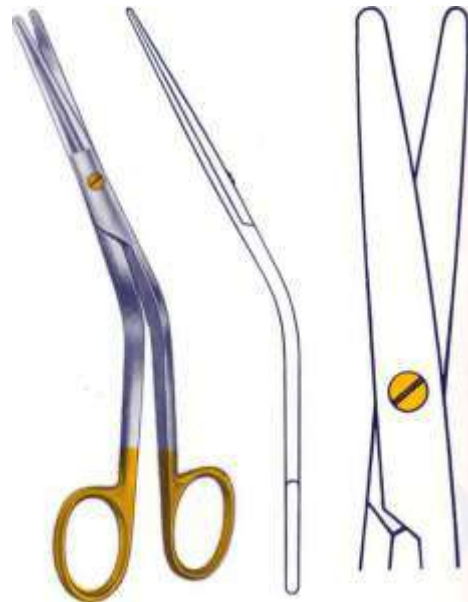

COTTLE  
SUPERCUT RIS  
NF.15.51.166  
16 cm/ 6¼"



# Nasal Instruments

Cartilage knife



MASING  
NF.15.19.13  
13 cm/ 5¼"

Septum knife, adjustable



spare blade

BRUENINGS  
NF.15.19.16  
16 cm/ 6¼"



FREER  
NF.15.20.15  
15 cm/ 6"



FREER  
NF.15.20.16  
16 cm/ 6¼"



FREER  
NF.15.20.17  
16 cm/ 6¼"

Mucosa knife

# Nasal Instruments

Swivel knife

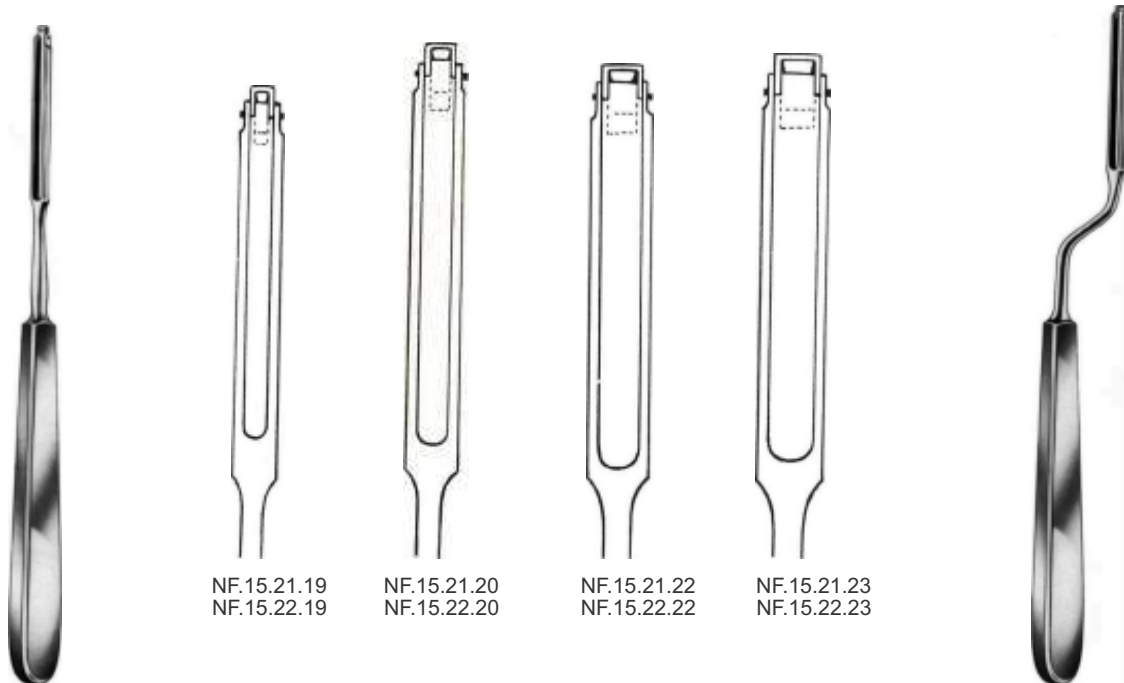

NF.15.21.19  
NF.15.22.19

NF.15.21.20  
NF.15.22.20

NF.15.21.22  
NF.15.22.22

NF.15.21.23  
NF.15.22.23

**BALLENGER**  
NF.15.21.19 3 mm  
NF.15.21.20 4 mm  
NF.15.21.22 5 mm  
NF.15.21.23 6 mm  
20 cm/ 8"

5 mm **BALLENGER**  
NF.15.22.19 3 mm  
NF.15.22.20 4 mm  
NF.15.22.22 5 mm  
NF.15.22.23 6 mm  
20 cm/ 8"

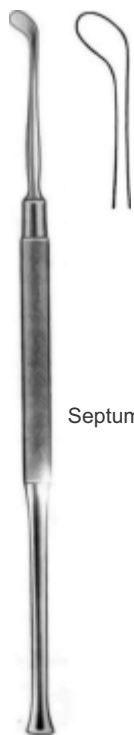

Septum knife

**FREER**  
NF.15.27.21  
19 cm/ 7½"

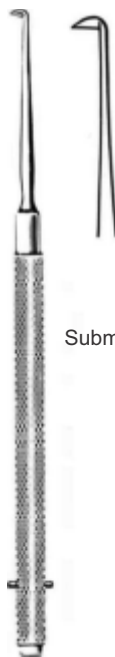

Submucosa knife

**FREER-INGALS**  
NF.15.27.17  
17 cm/ 6¾"

3.5 mm

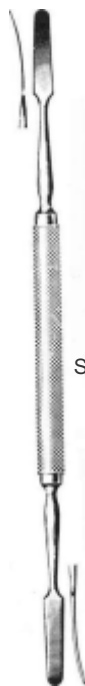

Sharp/blunt

**KILLAN**  
NF.15.34.18  
18 cm/ 7¼"



Sharp/blunt

**KILLIAN**  
NF.15.34.22  
23 cm/ 9"

# Nasal Instruments

## Septum gouges



**BALLENGER**  
NF.15.24.16 4 mm  
NF.15.24.17 6 mm  
16 cm/ 6¼"



**FREER**  
NF.15.25.16 4 mm  
NF.15.25.17 6 mm  
17 cm/ 6¾"



**KILLIAN**  
NF.15.25.46  
16 cm/ 6¼"



**KILLIAN-CLAUS**  
NF.15.25.47  
16 cm/ 6¼"

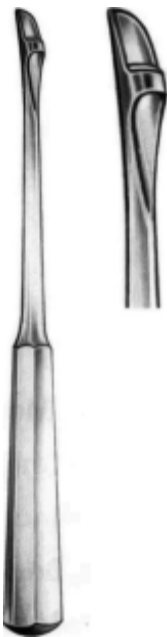

**FAULKNER**  
NF.15.25.57  
17 cm/ 6¾"

Cinzel para la apertura endonasal del seno maxilar

# Nasal Instruments



5 mm

Sharp

Blunt

FREER  
NF.15.27.22  
19 cm / 7 1/2"

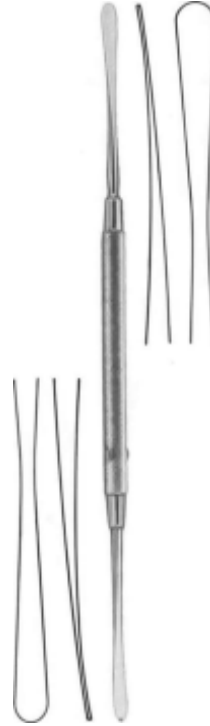

Sharp / Blunt

FREER  
NF.15.28.21  
21 cm / 8 1/4"

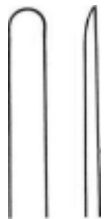

NF.15.29.11

Sharp



NF.15.29.12

Blunt



KILLIAN  
17 cm / 6 3/4"



Blunt

HALLE  
NF.15.30.32  
17 cm / 6 3/4"

# Nasal Instruments



HOWARTH  
NF.15.30.40  
21.5 cm/ 8½"



PENNINGTON  
NF.15.30.50  
20 cm/ 8"



PIERCE  
NF.15.30.55  
20 cm/ 8"

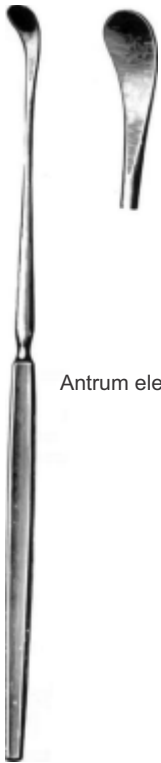

Antrum elevator

SEWALL  
NF.15.30.70  
20 cm/ 8"

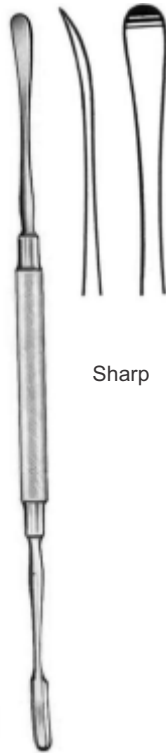

Sharp

FREER-JOSEPH  
NF.15.30.79  
19.5 cm/ 7¾"



Sharp/Blunt

HAJEK-BALLENGER  
NF.15.30.80  
20 cm/ 8"

# Nasal Instruments



**KISTNER**  
17 cm/ 6¾"



NF.15.31.60



NF.15.31.61



Obturator

CHONA HOOK



NF.15.31.62  
14.5 cm/ 5¾"



**KILLIAN**  
NF.15.31.63  
15 cm/ 6"

**LANGE**  
NF.15.31.65  
23 cm/ 9"

# Nasal Instruments

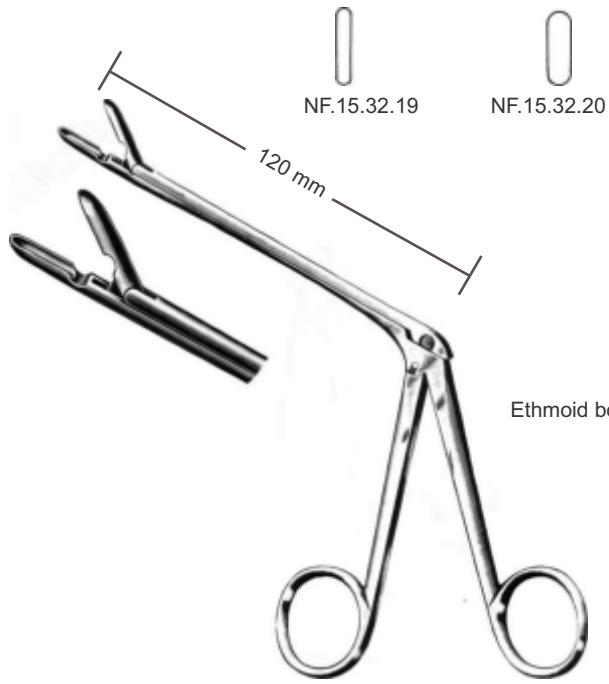

Ethmoid bone forceps

TAKAHASHI

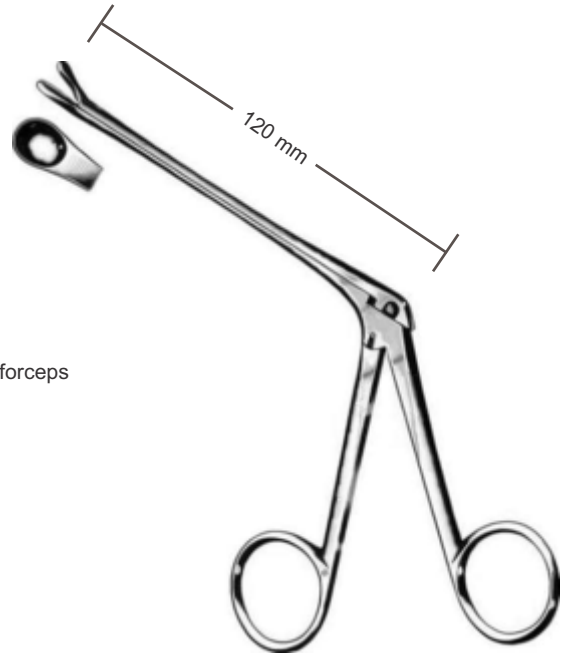

WATSON-WILLIAMS  
NF.15.33.19



FANOUS  
NF.15.33.21

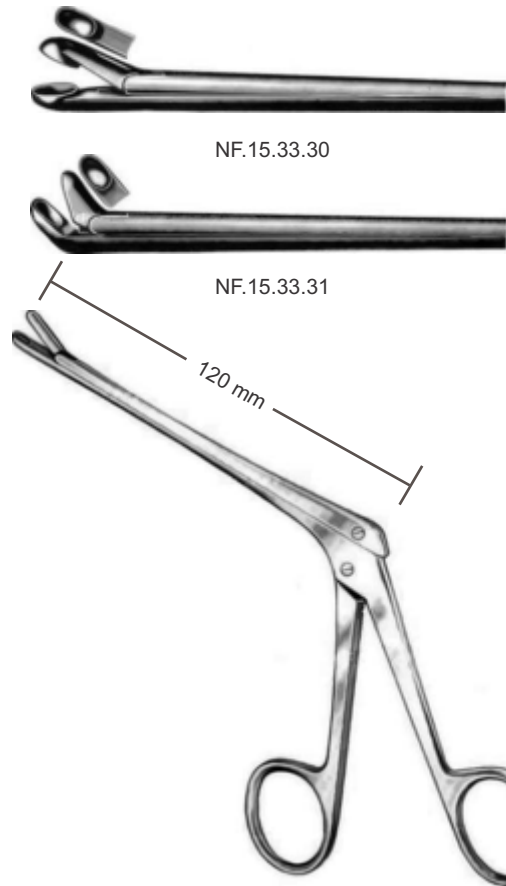

WATSON-WILLIAMS

# Nasal Instruments



LUC-BRUENINGS  
(HEYMANN)  
18 cm / 7¼"



NF.15.34.11  
# 1



NF.15.34.12  
# 2

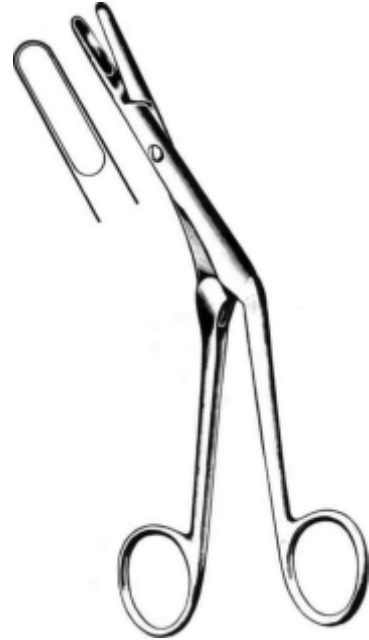

CRAIG  
NF.15.34.15  
17 cm / 6¾"



CRAIG-DOMNICK  
17 cm / 6¾"



NF.15.34.16



NF.15.34.17



LUC  
19 cm / 7½"



NF.15.34.21  
# 1



NF.15.34.22  
# 2

Ethmoid bone forceps



NF.15.34.23  
# 3



# Nasal Instruments

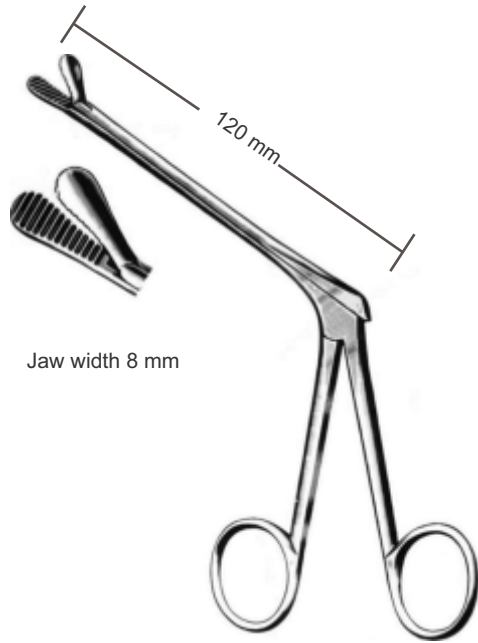

Jaw width 8 mm

BLAKESLEY  
NF.15.34.51

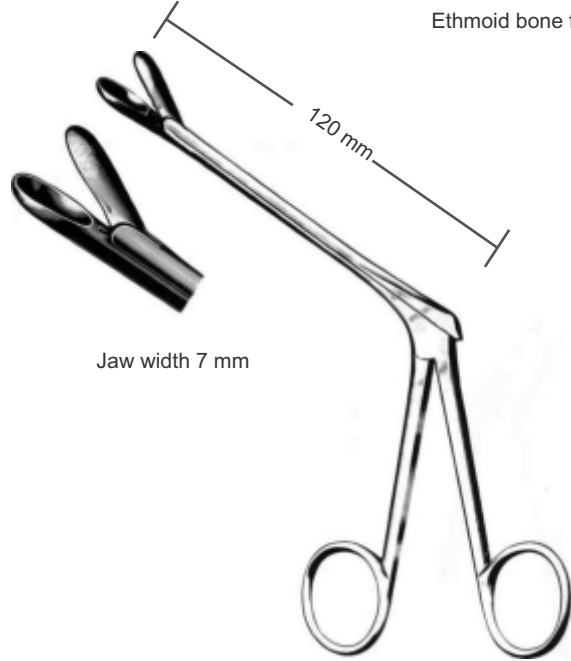

Ethmoid bone forceps

Jaw width 7 mm

WATSON-WILLIAMS  
NF.15.34.55

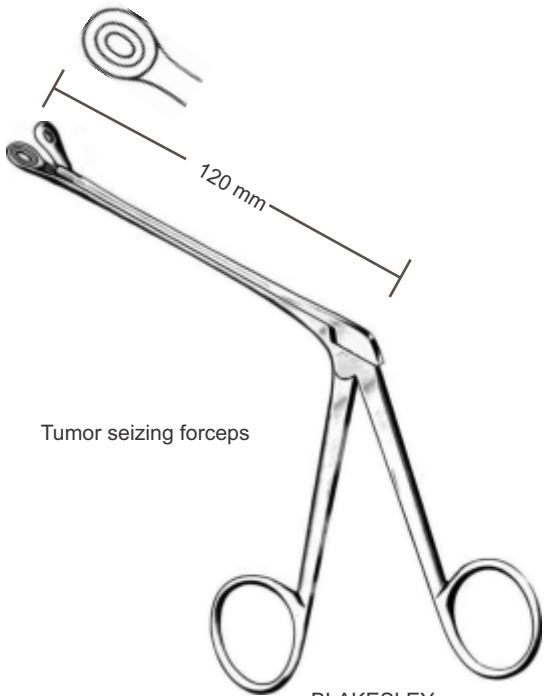

Tumor seizing forceps

BLAKESLEY  
(LEWIS)



NF.15.34.61



NF.15.34.62



NF.15.34.63

# Nasal Instruments

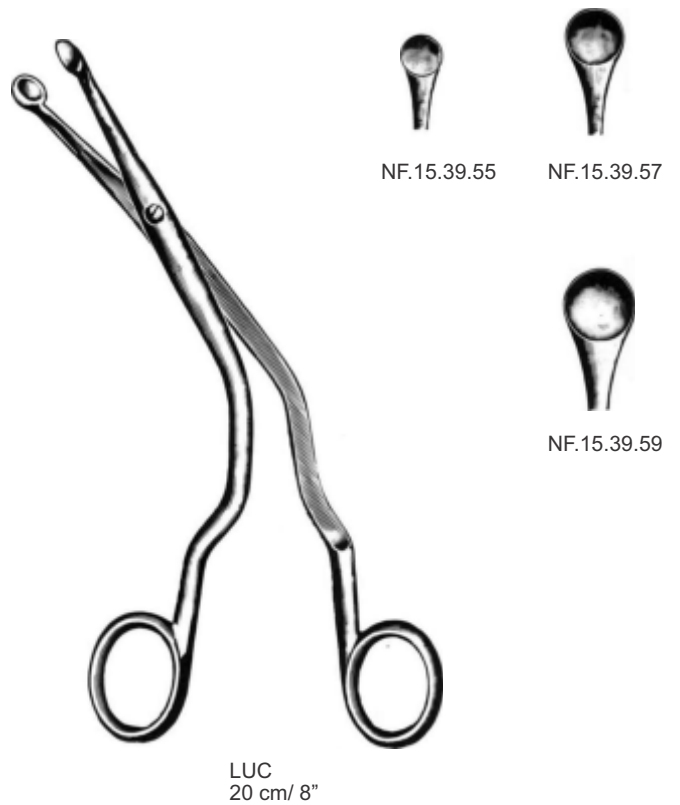
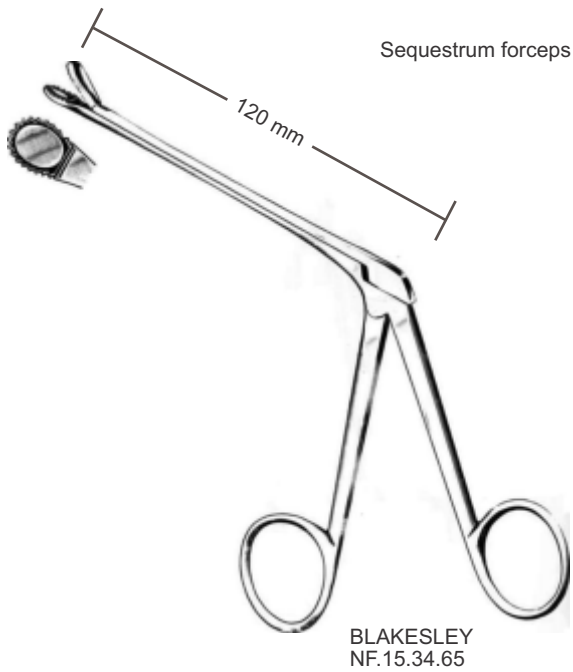

# Nasal Instruments



**BRUENINGS**  
19 cm / 7½"

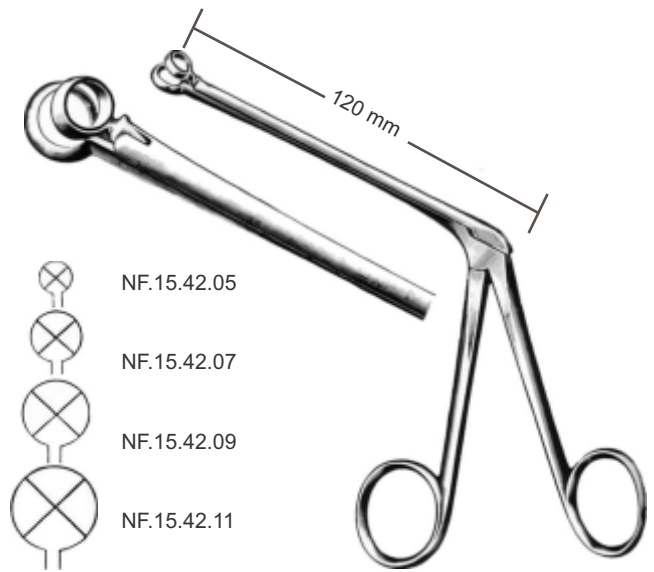
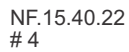

**HARTMANN**  
NF.15.42.05 # 1  
NF.15.42.07 # 2  
NF.15.42.09 # 3  
NF.15.42.11 # 4

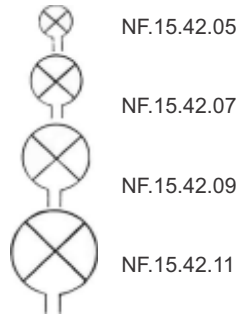

**WATSON-WILLIAMS**  
NF.15.43.01 # 1  
NF.15.43.02 # 2  
NF.15.43.03 # 3

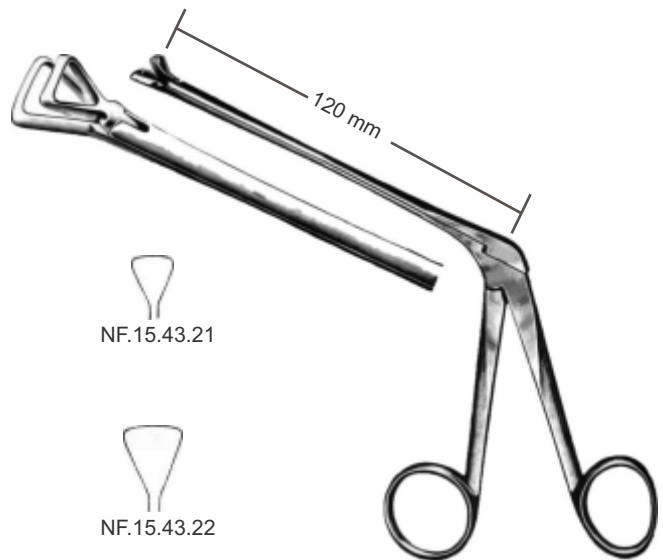

**SCHMEDEN**  
NF.15.43.21 # 1  
NF.15.43.22 # 2  
NF.15.43.23 # 3



# Nasal Instruments

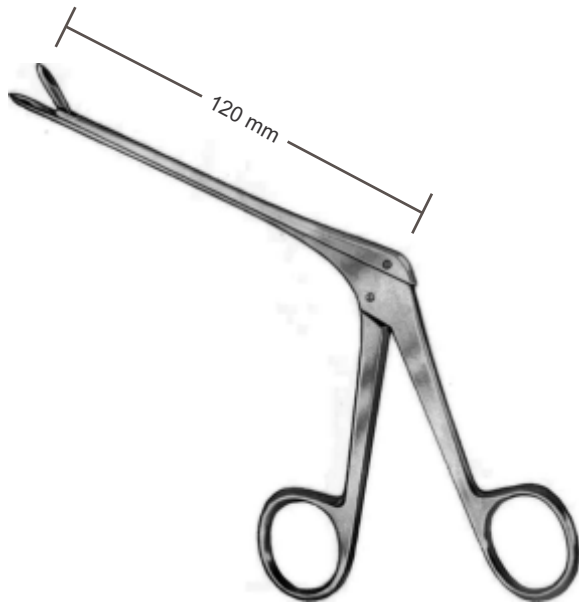

WEIL-BLAKESLEY  
19 cm / 7½"



NF.15.44.01  
# 1



NF.15.44.02  
# 2



NF.15.44.03  
# 3



NF.15.44.04  
# 4

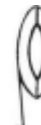

NF.15.44.05  
# 5

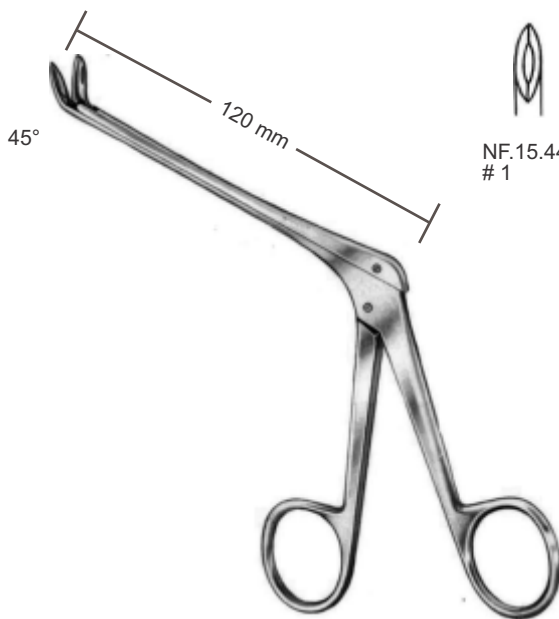

WEIL-BLAKESLEY



NF.15.44.10  
# 1



NF.15.44.11  
# 2



NF.15.44.12  
# 3



NF.15.44.13  
# 4



NF.15.44.14  
# 5

Ethmoid bone forceps

# Nasal Instruments



WELLBLAKESLEY



NF.15.45.11  
# 1



NF.15.45.12  
# 2



NF.15.45.13  
# 3



NF.15.45.14  
# 4

# Nasal Instruments



STRUYCKEN  
NF.15.46.21



HENKE  
NF.15.45.15



NF.15.45.21    NF.15.45.22    NF.15.45.23

HAJEK-GRUENWALD  
NF.15.45.21 #1  
NF.15.45.22 #2  
NF.15.45.23 #3



NF.15.45.31    NF.15.45.32    NF.15.45.33    NF.15.45.34

MYLES  
NF.15.45.31 #1  
NF.15.45.32 #2  
NF.15.45.33 #3  
NF.15.45.34 #4

# Nasal Instruments

Antrum punch, retrograde cutting



NF.15.47.51

Up cutting



NF.15.47.52

Cutting right

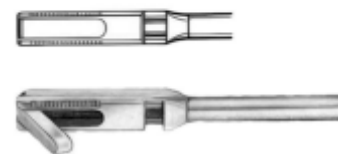

NF.15.47.53

Cutting left



STAMMBERGER

# Nasal Instruments



JANSEN-MIDDLETON  
NF.15.48.19  
19 cm/ 7½"

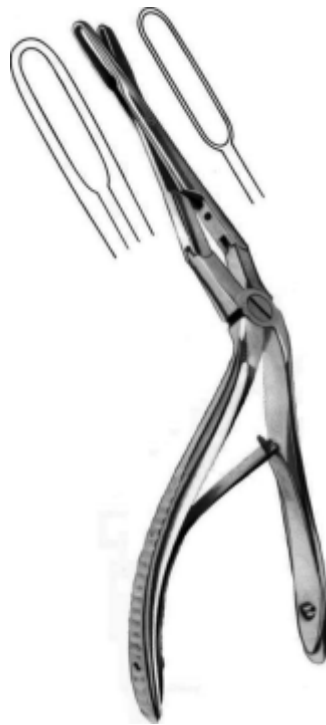

JANSEN-MIDDLETON  
NF.15.49.19  
19 cm/ 7½"



# Nasal Instruments

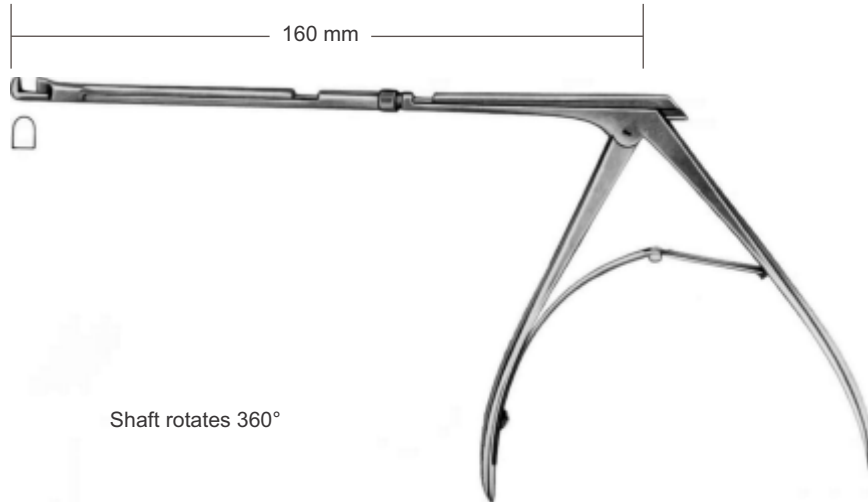

HAJEK-KOFLER  
NF.15.66.10

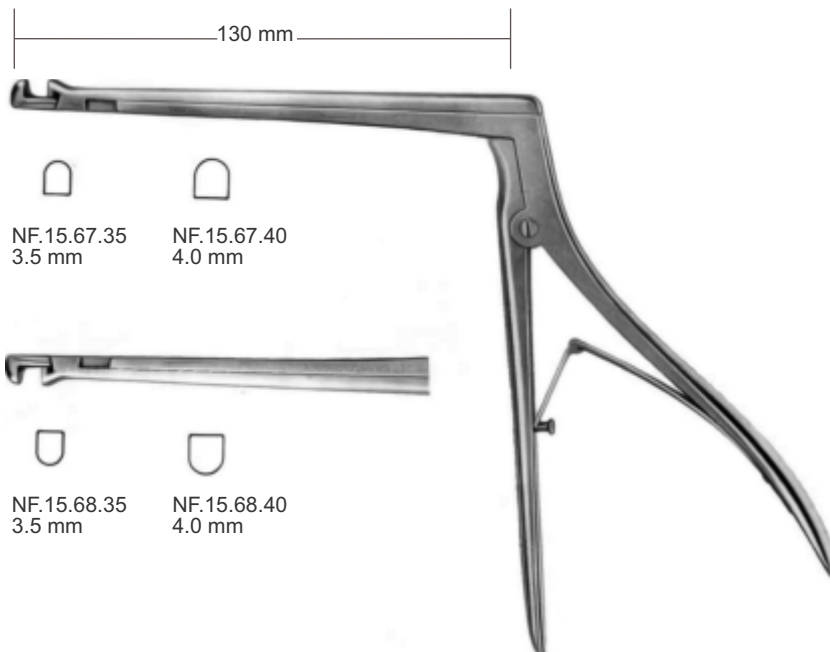

HAJEK



# Nasal Instruments

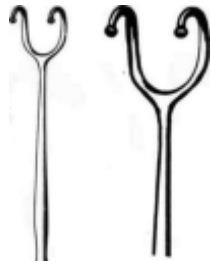

10 mm

Alar retractor

FOMON  
NF.15.01.17  
17 cm/ 6¾"



10 mm

With guide

NEIVERT  
NF.15.01.19  
19.5 cm/ 7¾"



18 mm

With guide

MASING  
NF.15.01.20  
20 cm/ 8"



10 mm

COTTLE-NEIVERT  
NF.15.01.21  
21 cm/ 8¼"

"Finger-ring" retractor



10 mm

Sharp



MILLARD (COTTLE)  
NF.15.01.23  
5.5 cm/ 2¼"



10 mm

COTTLE  
NF.15.01.44  
15 cm/ 6"

# Nasal Instruments



Alar retractor

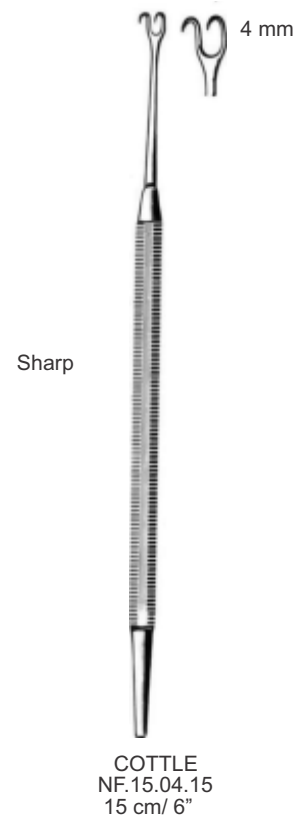

# Nasal Instruments

14 cm



Wide

COTTLE  
NF.15.05.14  
14 cm / 5½"

22 x 13 mm



Alar retractor

COTTLE  
NF.15.05.16  
15 cm / 6"



AUFRICHT-WALTER  
NF.15.06.14  
13.5 cm / 5¾"

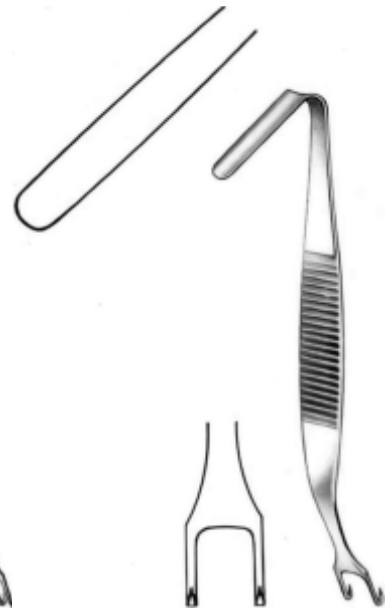

AUFRICHT-WALTER  
NF.15.06.15  
13.5 cm / 5¾"

40 x 13 mm



blunt

AUFRICHT  
NF.15.06.17  
13.5 cm / 5¾"

45 x 9/7 mm



AUFRICHT  
NF.15.10.19  
18 cm / 7¼"

# Nasal Instruments



NF.16.07.01  
No. 1 - 40 mm



NF.16.07.02  
No. 2 - 50 mm



NF.16.07.03  
No. 3 - 55 mm

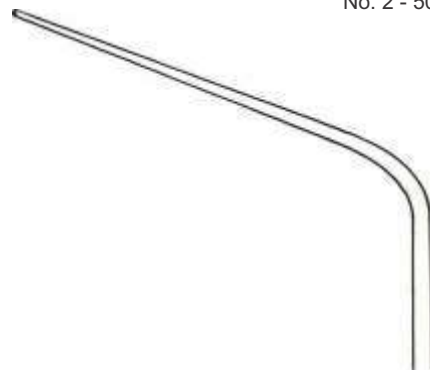

NF.16.07.04  
No. 4 - 70 mm

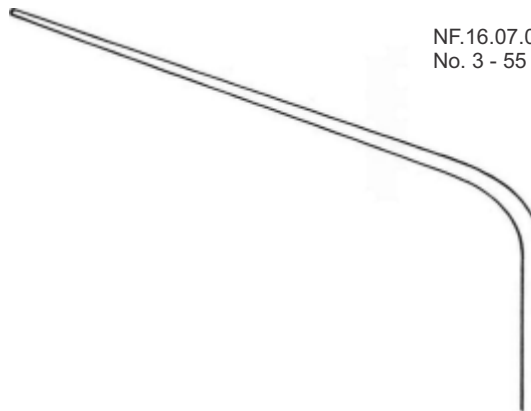

COTTLE

NF.16.07.00  
Set/4 sizes (No, 1-4)

# Nasal Instruments



JOSEPH  
NF.16.11.06  
15 cm/ 6"

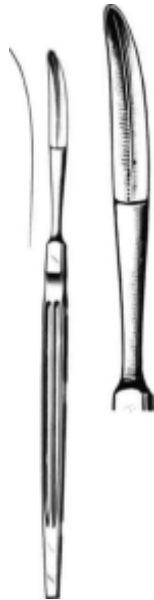

JOSEPH  
NF.16.11.08  
15 cm/ 6"

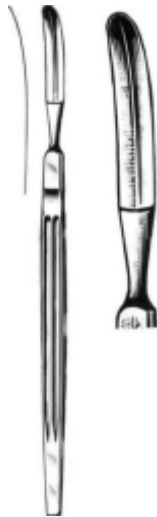

FOMON  
NF.16.11.15  
15 cm/ 6"



JOSEPH  
NF.16.12.15  
15 cm/ 6"



Nasal knife

COTTLE  
NF.16.13.14  
14 cm/ 5½"

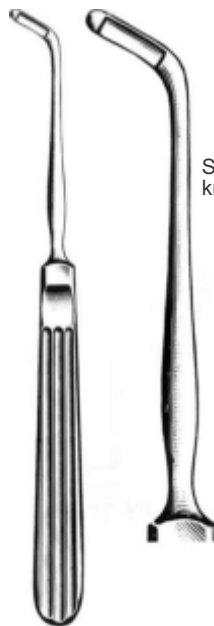

Septum cartilage  
knife

JOSEPH  
NF.16.13.16  
16 cm/ 6¼"

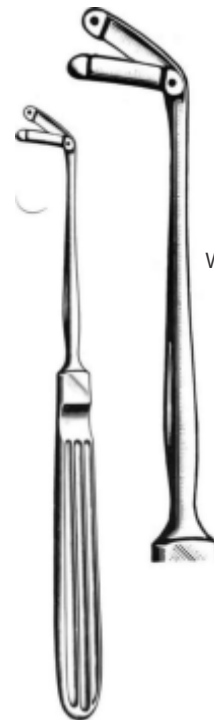

With blade guard

MALTZ  
NF.16.13.26  
16 cm/ 6¼"

# Nasal Instruments



CONVERSE  
NF.16.14.15  
15 cm/ 6"



Nasal knife

COTTLE  
NF.16.14.16  
15 cm/ 6"

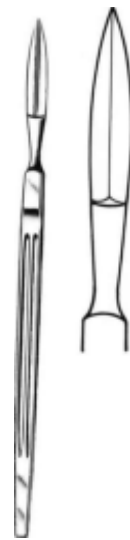

COTTLE  
NF.16.15.15  
15 cm/ 6"

# Nasal Instruments

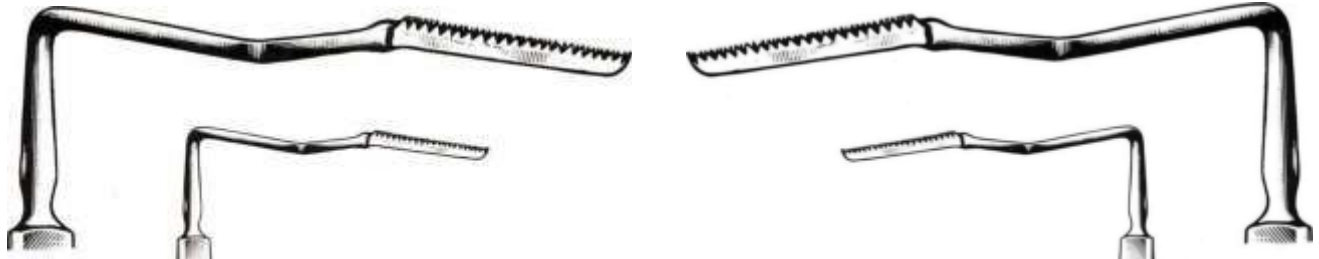

Guide and guard for nasal saw



JOSEPH  
NF.16.20.15  
15 cm/ 6"

JOSEPH  
NF.16.17.26  
L

JOSEPH  
NF.16.17.27  
R



JOSEPH  
NF.16.18.23  
17 cm/ 6¾"



JOSEPH  
NF.16.19.24  
R.17 cm/ 6¾"



JOSEPH  
NF.16.20.24  
L.17 cm/ 6¾"



# Nasal Instruments



**COTTLE**  
NF.16.21.24  
21 cm / 8¼"

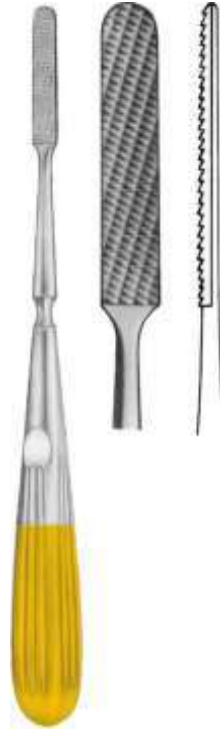

**COTTLE "TC"**  
NF.16.21.25  
20.5 cm / 8"

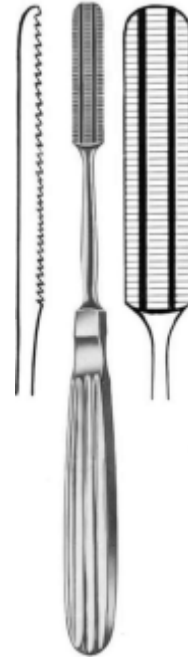

**MALTZ**  
NF.16.22.25  
18 cm / 7¼"

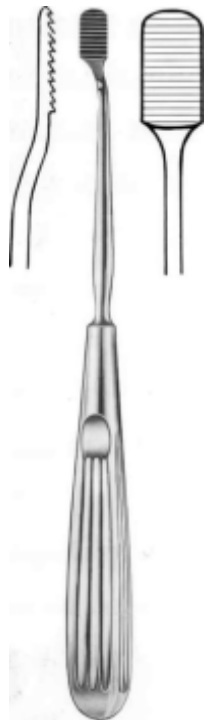

**LEWIS**  
NF.16.24.26  
20 cm / 8"

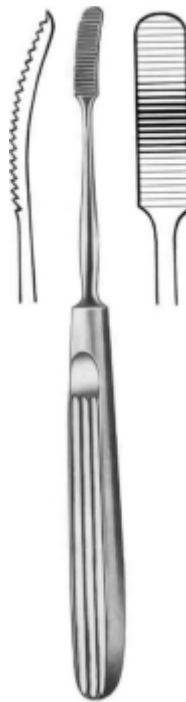

**NF.16.23.47**  
19.5 cm / 7¾"

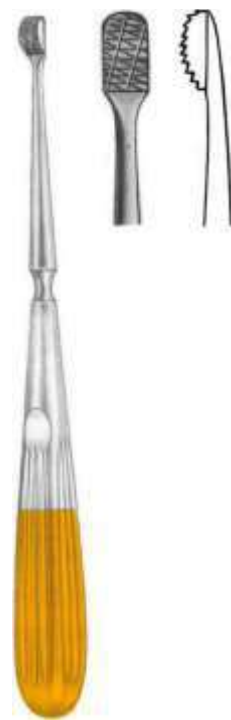

**LEWIS "TC"**  
NF.16.23.50  
19.5 cm / 7¾"

# Nasal Instruments



Cartilage Abraders

DINGMAN  
NF.16.24.10  
Set of 2 (# 1 and 2)



DINGMAN  
NF.16.24.36  
15 cm/ 6"  
# 2 - R



AUFRICHT  
NF.16.25.26  
21 cm/ 8¼"

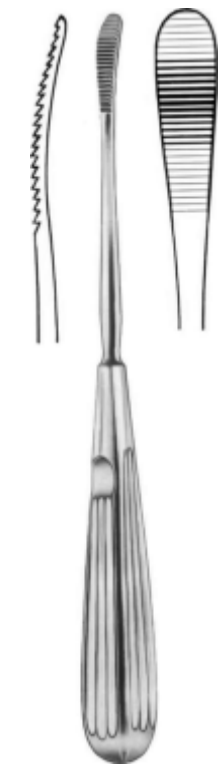

AUFRICHT  
NF.16.25.27  
21 cm/ 8¼"



AUFRICHT  
NF.16.25.28  
21 cm / 8¼"



FOMON  
NF.16.25.32  
22 cm/ 8¾"

# Nasal Instruments

Bone splinters are pushed through the perforated working ends. This avoids plugging of the rasps and they can be cleaned easily

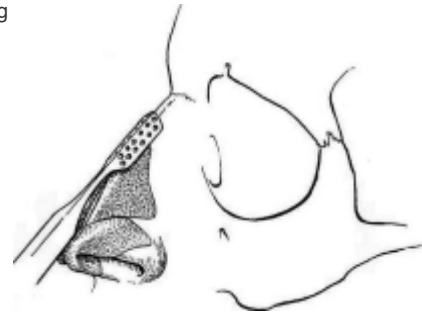

**OBWEGESER**  
NF.16.25.41 Delicate pattern    NF.16.25.42 Medium fine



**OBWEGESER**  
NF.16.25.43 Delicate pattern    NF.16.25.44 Medium fine



**OBWEGESER**  
NF.16.25.45 Delicate pattern    NF.16.25.56 Medium fine

One working end of the instruments operates by pushing, the other by pulling.

# Nasal Instruments

Nasal files



CONVERSE  
NF.16.25.65  
18.5 cm / 7¼"

Nasal rasp



MASING  
NF.16.25.70  
21 cm / 8¼"



MASING  
NF.16.25.71  
21 cm / 8¼"

# Nasal Instruments



20 cm / 8"  
"TC"



1



3



5



7



9



2

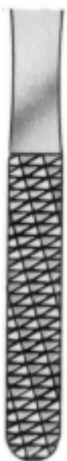

4

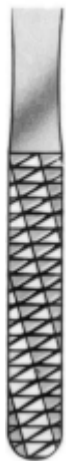

6



8



10

NF.16.25.80

NF.16.25.81

NF.16.25.82

NF.16.25.83

NF.16.25.84

# Nasal Instruments

Septum straightening forceps



ASCH  
NF.16.29.21  
22 cm / 8¾"

Septum Cutter

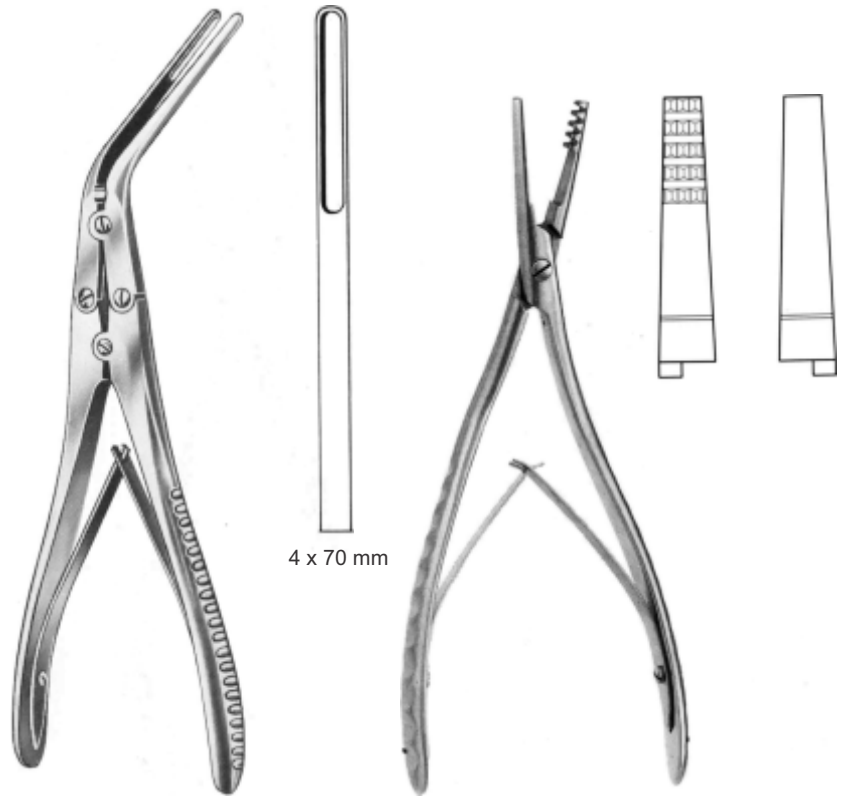

KRESSNER  
NF.16.29.22  
21 cm / 8¼"

OBWEGESER  
NF.16.29.23  
18.5 cm / 7¼"

# Nasal Instruments

## Septum Straightening Forceps



WALSHAM  
"UNIVERSAL"  
NF.16.30.21  
23 cm/ 9"



R  
NF.16.30.22



L  
NF.16.30.23

WALSHAM  
NF.16.30.22  
R.23 cm/ 9"

WALSHAM  
NF.16.30.23  
L.23 cm/ 9"

Dismantleable



COTTLE-FOMON  
NF.16.30.24  
21 cm/ 8¼"

# Nasal Instruments

Septum Morselizer

With protective guard



RUBIN  
NF.16.30.31  
21 cm/ 8¼"



Protective guard only

According to the operating needs, the cap may be placed either on the right or the left jaw

Cartilage morselizer

25 x 20 mm

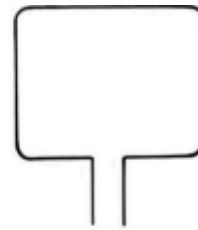

TSCHOEPE  
NF.16.30.32  
19 cm/ 7½"



# Nasal Instruments

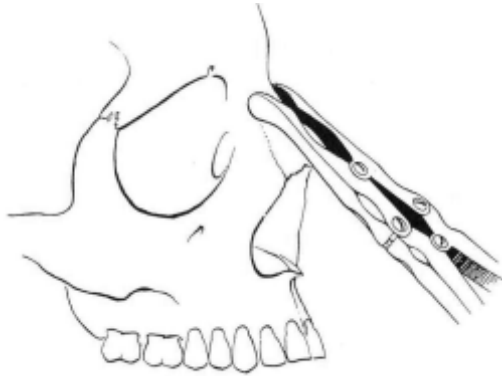

Used to reduce the angle between nose and forehead by delicate biting of the bone.



**OBWEGESER**  
18.5 cm / 7¼"



NF.16.30.34  
4 mm



NF.16.30.36  
6 mm



NF.16.30.38  
8 mm

# Nasal Instruments

Measuring instrument



JOSEPH  
NF.16.30.47  
17 cm/ 6¾"

Graduated in centimeters

Mucosa needle holder

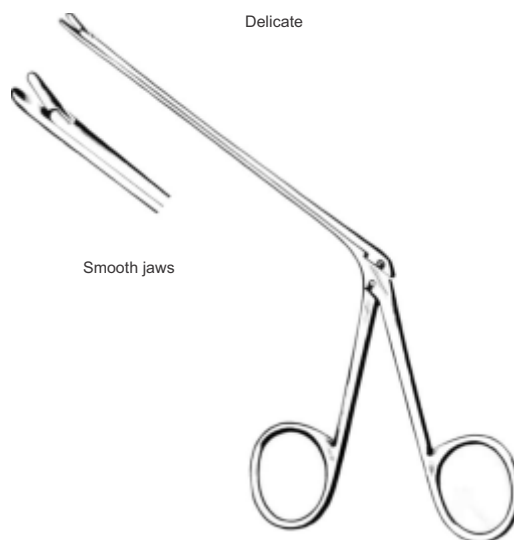

COTTLE-MASING  
NF.16.30.56  
60 mm

Length of shaft

COTTLE-MASING  
NF.16.30.59  
90 mm

Length of shaft

# Nasal Instruments

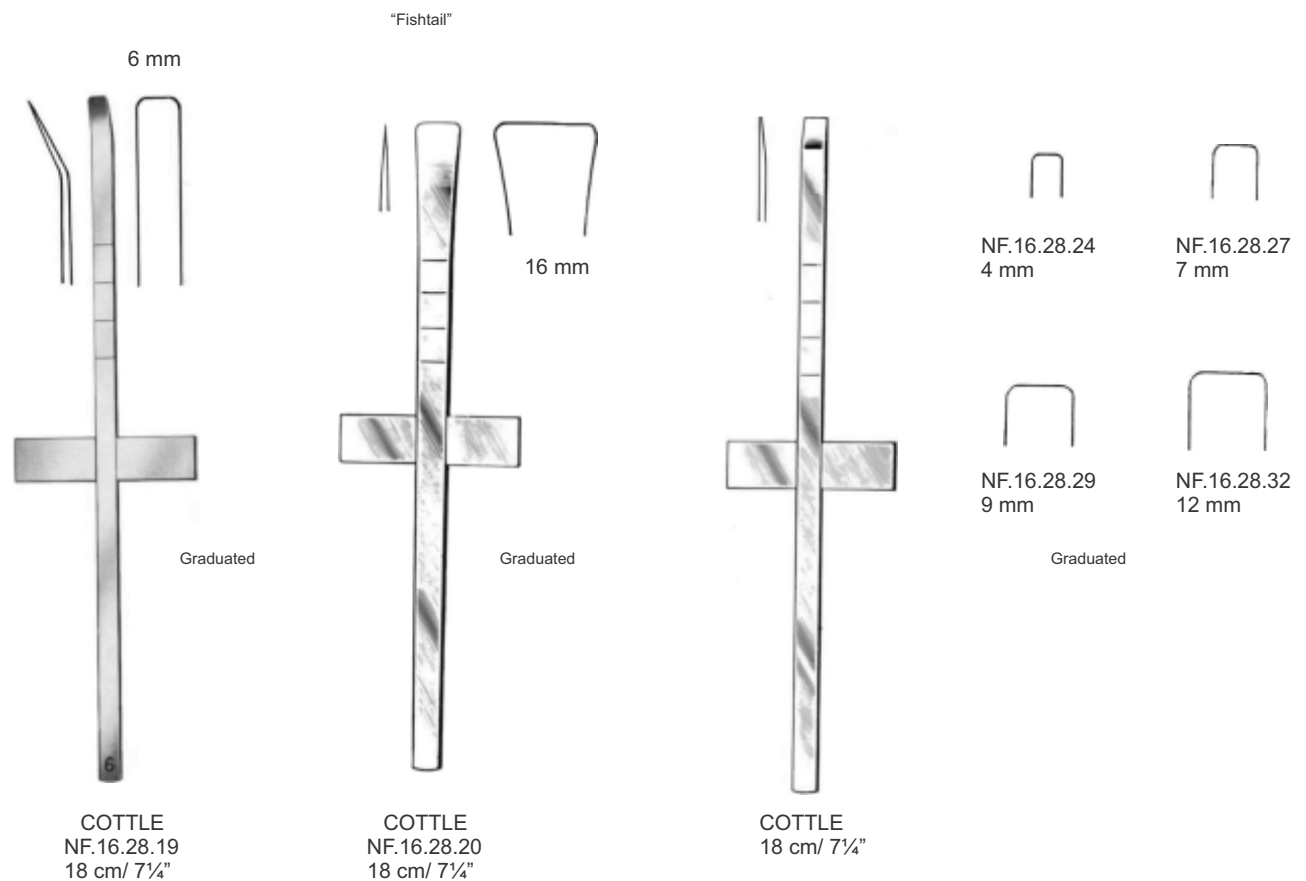
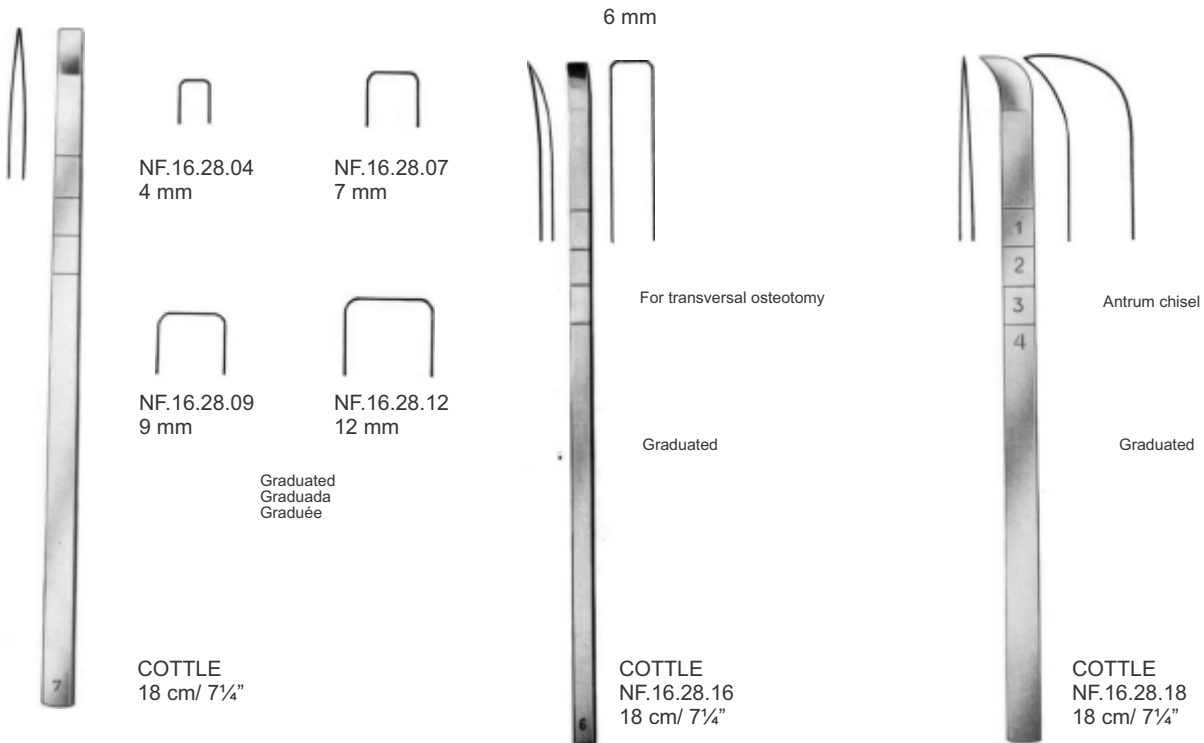

# Nasal Instruments

"Fishtail"

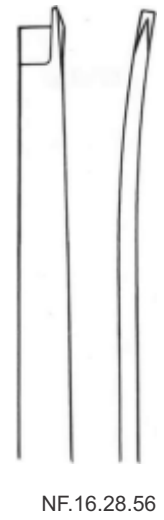
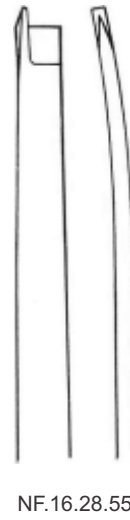
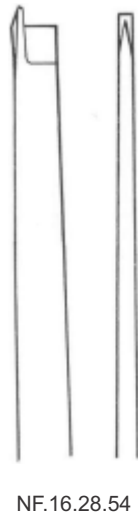
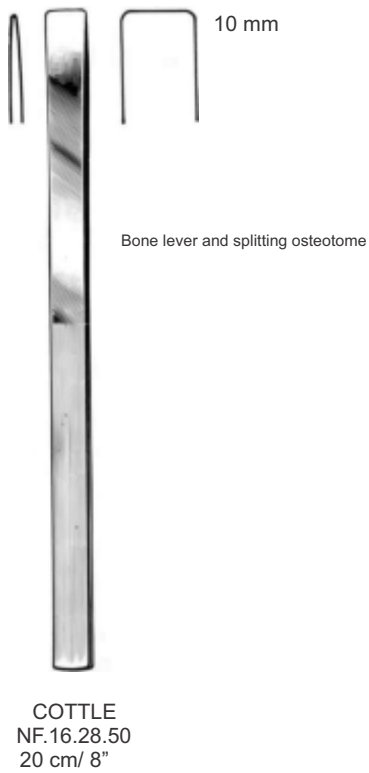
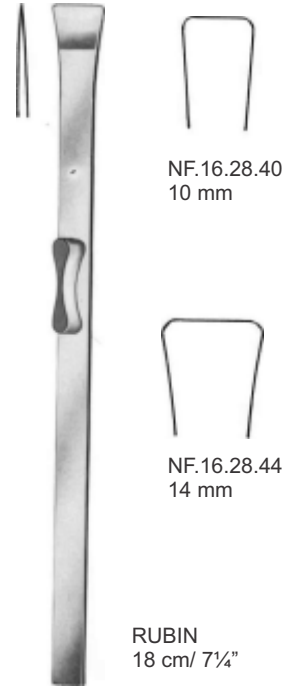
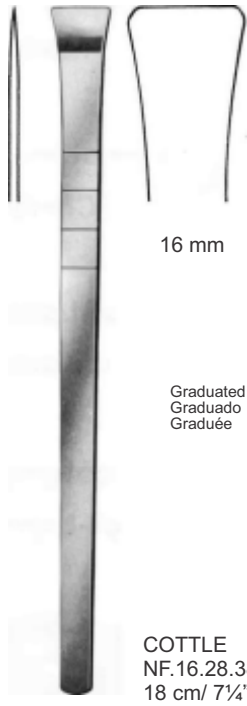

# Nasal Instruments

3 mm



NF.16.28.63

5 mm



NF.16.28.65

2 mm



NF.16.28.72

3 mm

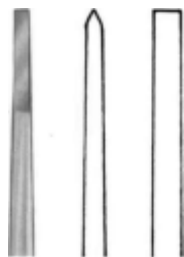

NF.16.28.73

4 mm



NF.16.28.74

7 mm

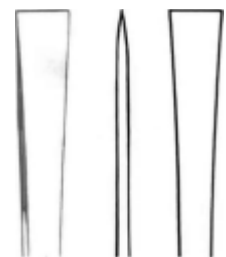

NF.16.28.77



WALTER  
19 cm - 7½"

9 mm

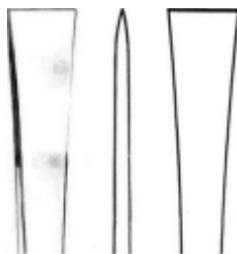

NF.16.28.79

12 mm

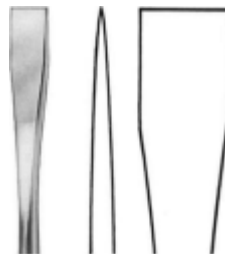

NF.16.28.82

6 mm



NF.16.28.86

# Nasal Instruments

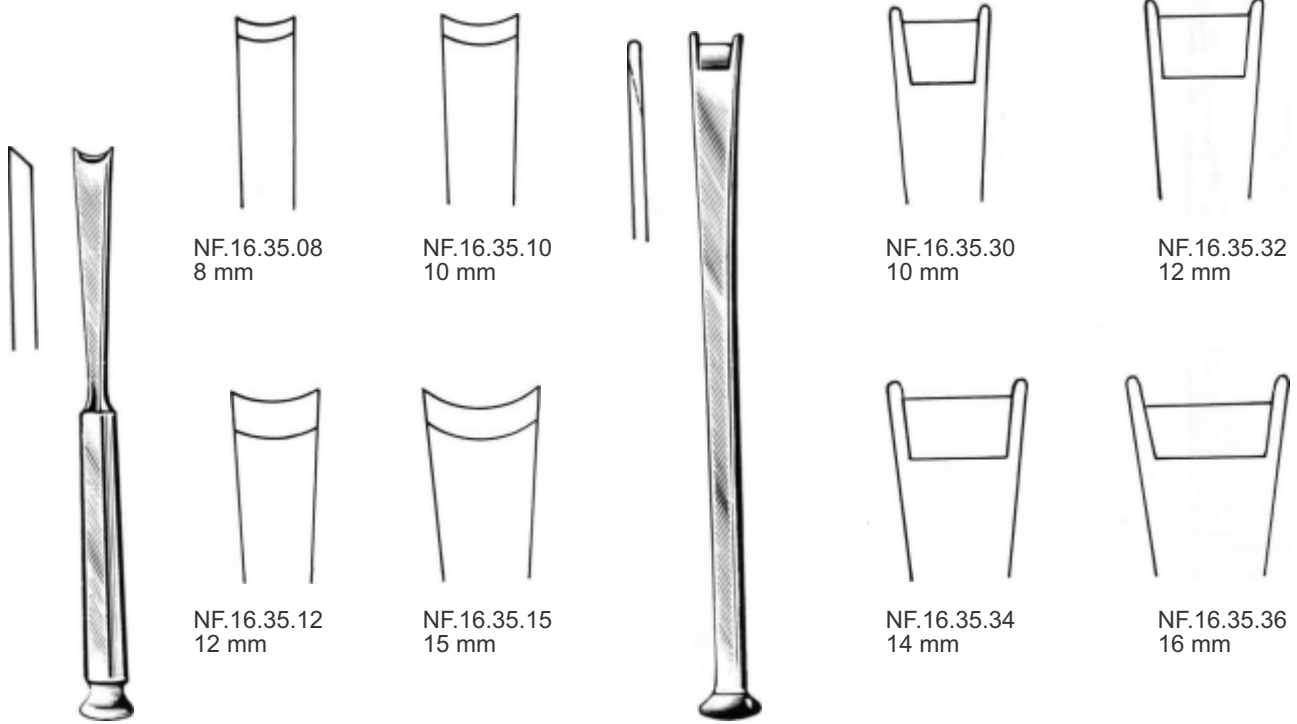

**MCINDOE**  
16 cm - 6¼"

**MOBERG**  
18 cm - 7¼"

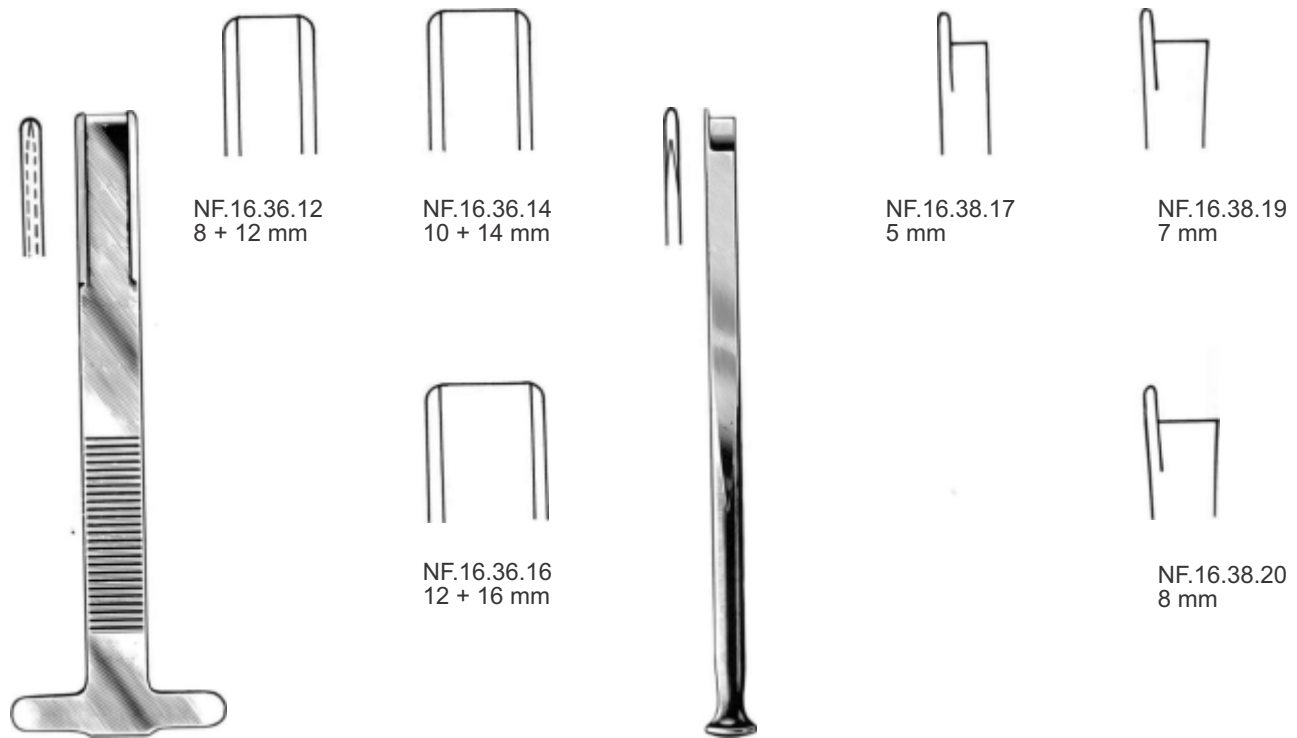

**RUBIN**  
18 cm - 7¼"

**FOMON**  
17 cm - 6¾"

# Nasal Instruments



CINELLI  
16 cm - 6¼"

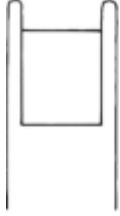

NF.16.39.10  
10 mm

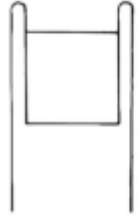

NF.16.39.12  
12 mm

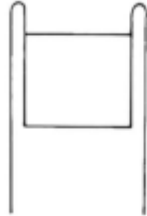

NF.16.39.14  
14 mm

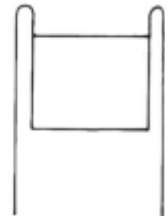

NF.16.39.16  
16 mm

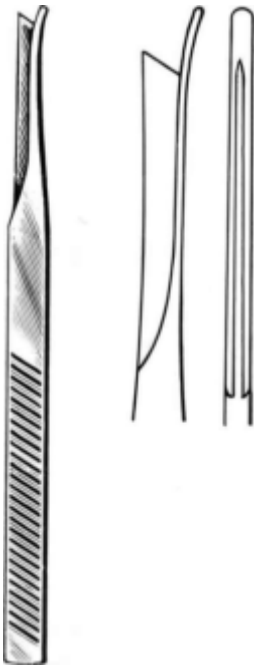

SILVER  
NF.16.40.01  
18 cm - 7¼"

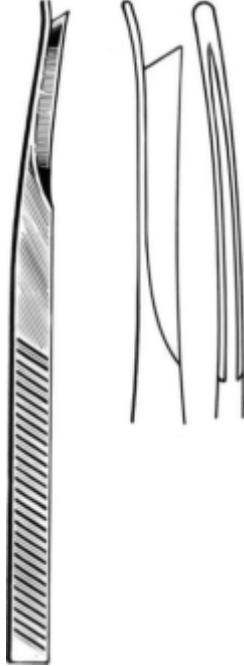

SILVER  
NF.16.40.02  
18 cm - 7¼"

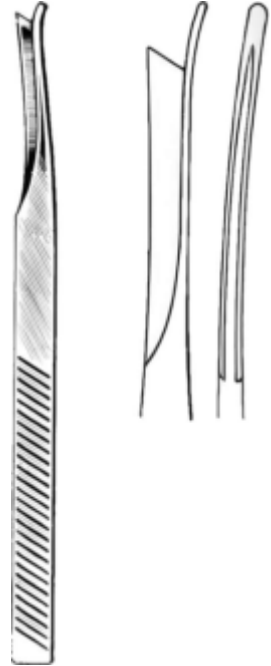

SILVER  
NF.16.40.03  
18 cm - 7¼"

# Nasal Instruments



**COTTLE**  
18 cm - 7¼"

8 mm



Raspatory

NF.16.31.19

Sharp  
Agudo  
Tranchant

8 mm



Elevator

NF.16.31.20

Blunt  
Rombo  
Mousse

Sharp

8 mm



Septum raspatory

**JOSEPH-MASING**  
NF.16.31.48  
22 cm - 8¾"

Blunt

6 mm



Septum elevator

**YANKAUER**  
NF.16.31.55  
18 cm - 7¼"



# Nasal Instruments

Blunt



Elevator for fracture repositioning  
of the nasal bone

NF.16.31.60  
17 cm/ 6¾"

Sharp



Raspatory

CONVERSE  
NF.16.31.65  
18 cm/ 7¼"

Blunt



Nasal fracture elevator

BOLES  
NF.16.31.69  
19 cm/ 7½"

Blunt



Septum displacer

GOLDMANN  
NF.16.31.75  
17 cm/ 6¾"

# Nasal Instruments

## Periosteal Elevators



COTTLE  
NF.16.32.21  
21 cm / 8¼"



MASING  
NF.16.32.52  
22 cm / 8¾"

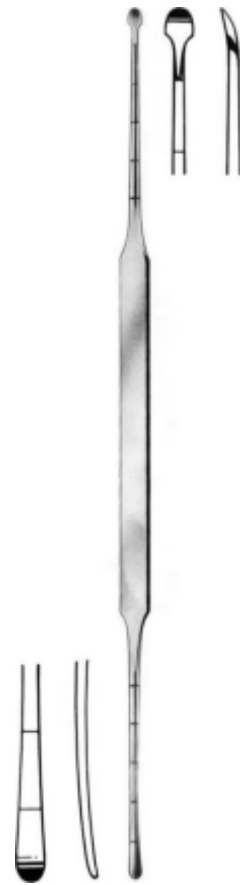

COTTLE  
NF.16.32.23  
23 cm / 9"

# Nasal Instruments

Suction elevator



NF.16.33.21  
21 cm / 8¼"

Suction raspatory



NF.16.33.20  
20 cm / 8"

Septum elevator



COTTLE  
16 cm / 6¼"

# Nasal Instruments

Periosteum comb and file



COTTLE  
NF.16.34.24  
23 cm/ 9"

Raspatory



COTTLE-MCKENTY  
NF.16.34.22  
22 cm/ 8¾"

Tunnelling elevator



COTTLE  
NF.16.34.23  
22 cm/ 8¾"

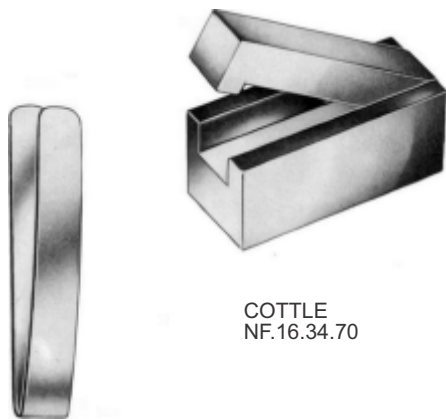

COTTLE  
NF.16.34.70

Cartilage crusher with Clamp for taking out the prepared material

# Nasal Instruments

Ø 30 mm, 300 g



1 plain face, 1 convex face

**COTTLE**  
NF.16.41.19  
19 cm/ 7½"

The round face is used of the  
Cartilage crusher PAN-34.70



**QUISLING**  
NF.16.42.17  
17 cm/ 6¾"

Intranasal mallet

# INDEX

Diagnostic	1-4
Probes . Cotton Carriers, Suction Instruments	5-24
Scissors	25-58
Micro Scissors	59-63
Scalpel & Knives	64-75
Dressing & Tissue Forceps	76-102
Sponge Forceps	103-109
Hemostatic Forceps	110-134
Dissecting Forceps	135-144
Needle Holders	145-163
Bandage Instruments	164-167
Mallets	168-173
Intestinal & Tissue Grasping Forceps	174-202
Gyneoclogy	203-253
Obstetrics	254-268
Bandage & Plaster Cast Instruments	269-273
Sterilization	274-277
Suture	278-286
Bone File, Elevators & Raspatories	287-312
Orthopedic Instruments(Bone Cutting Forceps, Bone Holding Forceps & Saws)	313-343
Orthopedic Instruments (Chisels & Gouges)	344-356
Orthopedic Instruments (Curettes)	357-366
Orthopedic Instruments (Bone Rongeurs)	367-377
Retractors	378-438
Self Retaining Retractors, Abdominal Retractors	439-478
Cardiovascular Instruments	479-505
Eye Instruments	506-523

# INDEX

Otology Instruments	524-588
Laryngoscopes	589-607
Dermatology Instruments	608-610
Holloware	611-618
Thoracic Instruments	619-626
Neurosurgery Instruements	627-653
Urology Instruments	654-663
Mouth & Throat Instruments	664-712
Nasal Instruments	713-772



Address: Sialkot 51040 Punjab, Pakistan.

Email: [nawroozsurgical72@gmail.com](mailto:nawroozsurgical72@gmail.com)

Contact: +92 3137879420