

# PLASTIC SURGERY INSTRUMENTS



Address: Sialkot 51040 Punjab, Pakistan.  
Email: [nawroozsurgical72@gmail.com](mailto:nawroozsurgical72@gmail.com)  
Contact: +92 3207987447

  
**NAWROOZ  
SURGICAL**  
Quality Makes Innovation



## PLASTIC SURGERY INSTRUMENTS

# Changes

NAWROOZ SURGICAL is committed to abiding by the highest quality standards and to exclusively marketing excellent products in order to guarantee each and every patient the opportunity to regain the best possible quality of life.

With a surface area of over 20,000m<sup>2</sup>, specifically reserved for medical implant production throughout its sites in the United States, Europe and North Africa, NAWROOZ SURGICAL can truly pride itself in its fine heritage in the field of top-quality sub-contracting. As the last addition to its 200 year-old international parent group, NAWROOZ SURGICAL offers established expertise in the manufacture of prostheses, implants and surgical instruments for orthopaedics, traumatology, extremities, spinal and dental surgery.

ANVIL MEDICAL CRAF, we consider that our most precious capital lies in our collaborators (Team members), without distinction of origin of culture and in their commitment to the company. Our purpose is to attract, to develop, to reward and to retain the best of them by offering them a professional environment secure and pleasant and the opportunity to succeed in a spirit of team and equity.

The safety of each and every one of them is a mandatory prerequisite towards achieving our aim.

All of the products we manufacture are used to improve the lives of many patients and, as such, the quality of each and every product must be beyond reproach. Our entire staff is perfectly aware of the final use of our products and they all strive to apply the highest possible quality standards and to abide by the regulatory requirements that govern our specific sector.



**NAWROOZ  
SURGICAL**

Quality Makes Innovation

## Cleaning & Serilization Instructions

### Description

Surgical and dental instruments are designed to perform specific functions such as cutting, grasping, clamping, dissecting, probing, retracting, draining, aspirating, suturing, or ligating. Surgical instruments may also be used to facilitate the insertion of surgical implants.

### Contraindication

Instruments should not be used for anything other than their intended use.

### Warning

Devices shall be used in accordance with these instructions for use. Read all sections of this insert prior to use. Improper use of this device may cause serious injury. In addition, improper care and maintenance of the device may render the device non-sterile prior to patient use and cause a serious injury to the patient or health care provider.

### Caution

- Nawrooz Surgical Are Supplied Non-sterile, Unless Otherwise noted and must be cleaned, lubricated (if required) and sterilized prior to use according to hospital protocol and procedures outlined in this document.
- Inappropriate use of instruments may result in patient injury, damaged or broken instruments.
- Proper cleaning, handling, sterilization and standard routine maintenance (such as sharpening, lubrication if applicable) will ensure that the instruments perform as intended and will extend their useful life.
- Delicate surgical/dental instruments require special handling to prevent damaging the tips. Use caution during cleaning and sterilization.
- Do not expose instruments to phenols or iodophors.
- Do not use dry heat sterilization for aluminum or plastic made, black coated or ebonized instruments.
- Do not apply excessive stress or strain at joints; misuse will result in mis alignment or cracks at the box locks or jaws.
- Rongeurs and bone cutting forceps should only be used to cut bone, never wire or pin. Do not twist or apply excessive stress during use.
- Wear appropriate protective gloves, eyewear and clothing when handling biologically contaminated instruments.
- Instruments manufactured from different metals or with special coating, should be processed separately to avoid electrolytic action between the different metals.
- Before use, inspect the instruments for possible damage, wear or non-functioning parts. Carefully inspect the critical, inaccessible areas, joints and all movable parts.
- Damaged or defective instruments should not be used or processed.

### Care And Handling

#### 1.Precleaning:

- Keep instruments moist and do not allow blood and/or bodily fluids to dry on the instruments.
- Remove gross contaminants with steady stream of lukewarm/cool water (below 110°F/43°C). Rinse each instrument thoroughly. Do not use saline or chlorinated solutions.
- Open jaws of hinged instruments for cleaning. Give special attention to joints and serrations. Instruments having more than one part or piece must be disassembled (if possible) to expose all surfaces to the cleaning process. Retain all parts to facilitate reassembly.
- Separate sharp and delicate surgical instruments. Avoid processing instruments of different metallic composition together.
- Keep ebonized instruments separate from other stainless steel instruments to avoid scratches to and removal of the ebonized coating.

**2.Rinse:** Rinse instruments thoroughly under warm distilled or demineralized water.

### 3.Cleaning:

#### Cleaning Precautions

- If appropriate, disassemble surgical instruments prior to cleaning and sterilization.
- Do not soak instruments in hot water, alcohol, disinfectants or antiseptics to avoid coagulation of mucus, blood or other body fluids. Do not exceed two hours soaking in any solution.
- Do not use steel wool, wire brushes, pipe cleaners or abrasive detergents to remove soil as these will damage the instrument and lead to corrosion.
- Microsurgical, plated and delicate instruments should be cleaned manually and should not be processed in an ultrasonic cleaner. Carefully protect the tips of delicate microsurgical instruments throughout the entire cleaning and sterilization process.
- To preserve the surface coating of ebonized instruments, keep ebonized instruments separate from other instruments and avoid mechanical cleaning and abrasive cleaners as these processes can scratch the surface and remove the surface coating.
- Color anodized aluminum instruments may lose their color through the use of conventional, mechanical treatment processes.

**A. Manual Cleaning:** To prevent formation of biofilm, cleaning should occur as soon as possible after instrumentation is used.

- Choose a cleaning solution appropriate for surgical/dental instruments and follow manufacturer's instructions for use.
- The use of neutral pH detergents is recommended to avoid corrosion, pitting and breakage.
- Using a small, clean hand-held brush, remove soil from all surfaces of instrument while fully immersed in solution

#### B. Ultrasonic And Mechanical Cleaning

- For ultrasonic cleaning, follow manufacturer's specifications for water level, concentration levels of cleaning agent and temperature.
- Use an ultrasonic cleaner to remove soil from hard to reach surfaces such as grooves, crevices and moving parts after gross soil has been removed.
- Open or disassemble instruments as appropriate.
- When using mechanical washer, make sure all instruments stay properly in place and do not touch or overlap each other.
- Do not allow ebonized instruments to come in contact with each other or other instruments.
- Always follow the manufacturer's specifications for automatic washer-sterilizers and use a free-rinsing, low-sudsing detergent with a neutral pH (6.0 - 8.5). Due to variations in water quality, the type of detergent and its concentration may require adjustment for optimal cleaning.

**4.Rinse And Dry:** Rinse all instruments thoroughly with distilled, pyrogen-free water to remove all traces of debris and cleansing agents. Make sure all internal lumens and ratchets are thoroughly rinsed. Instruments must be thoroughly dried and all residual moisture must be removed before they are stored. Use a soft, absorbent towel/cloth to dry external surfaces. Compressed air may be used to aid the drying process.

**5.Lubricate:** The use of a water soluble instrument lubricant that is compatible with the method of sterilization to be used is recommended before instruments are sterilized.

- After thoroughly cleaning the instruments, proper application of lubricants to all joints and movable mating surfaces will keep them moving freely and aid in protecting surface from mineral deposits.
- Proper lubrication is required for all instruments, regardless of surface coatings.
- Note that ultrasonic cleaners remove all lubrication; therefore, this maintenance procedure should be done routinely after ultrasonic cleaning and before sterilization.
- If following the lubricating procedure, do not rinse after this step.

## Cleaning & Serilization Instructions

### 6. Sterilization:

All devices must be processed in the completely open position (i.e. flushports, jaws, etc.) to allow sterilant contact of all surfaces.

All devices with concave surfaces shall be configured so that water pooling does not occur.

Sterilization Method	Temperature	Exposure Time	Dry Time
<b>High Vacuum Steam (Pre-vacuum)</b>			
Wrapped	270°F (132°C)	3 minutes minimum	N/A

<b>High Vacuum Steam (Pre-vacuum)</b>			
Unwrapped in containers	270°F (132°C)	4 minutes minimum	20 minutes
Perforated stacked/unstacked			
Solid unstacked			

<b>Gravity Steam</b>			
Unwrapped in containers	250°F (121°C)	45 minutes	20 minutes
Perforated unstacked			

<b>Gravity Steam</b>			
Wrapped in cassettes	250°F (121°C)	30 minutes	20 minutes
Unwrapped in containers			

<b>Ethylene Oxide (EtO)</b>			
Unwrapped in containers	131°F (55°C)	60 minutes (minimum) Concentration: 725 mg/l	Humidity: 70%  Aeration time: 8 hours minimum
Perforated unstacked			
Solid unstacked			

### 7. Storage

After sterilization, devices must remain in sterilization packaging and be stored in a clean, dry environment.

## Returned Goods Policy & Warranty

### Returned Goods Policy

1. Goods will be accepted for return for the following reasons and must be accompanied by a RGA.

- If shipment was made without Customer's authorization;
- If incorrect items were shipped;
- If defective items were shipped;
- If defective goods are covered by the standard warranty;
- If the goods were sent on evaluation basis.

2. To return goods, contact a Customer Service Representative by telephone for an RGA (Returned Goods Authorization) number. The RGA # must also be clearly indicated on the outside of the returned package.

Please have the following information:











- Reason you wish to return the goods;
  - Quantity, description, product number;
  - Date of Receipt of Order;
  - Customer's Purchase Order and the Carnegie Surgical invoice number;
  - All instruments that have been used must be cleaned and sterilized prior to shipment.
3. Shipment must be returned prepaid by Customer. Freight collect shipments will not be accepted.
4. If Customer intends to return equipment ordered in error, the following restocking charges and terms will apply:
- 25% within 90 days from date of shipment;
  - Goods must be returned unused, in the original carton, and in marketable condition;
  - Refurbishing and replacement charges will be added to the restocking charges for damaged or missing items;
  - No return after 90 days;
  - No refund on sterile, single-use disposable products.
  - No refund will be made on customized instruments.



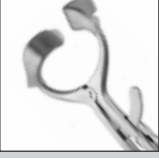

### Warranty

**NAWROOZ SURGICAL** stainless steel instruments are warranted for a period of one (1) years from the original date of purchase. **NAWROOZ SURGICAL** single patient use products are warranted for 90 days against defects in work-manship or materials that are discovered prior to initial use or expiration. If instruments should fail as the result of a defect in materials or workmanship, **Xelpov Surgical** is committed to take steps it believes are necessary to rectify the problem. These steps may include, but are not limited to, repair, replacement or supplying an alternative instrument. This warranty does not cover general maintenance such as cleaning and sharpening services required as a result of normal use. It does not include damage that is caused by misuse, improper care, the use of improper chemicals or cleaning methods, negligence, modification or unauthorized service by non- **XelpovSurgical** personnel, or normal wear. Damage to insulating coatings on electro-surgical instruments is excluded from the terms of this warranty.

The sole remedy under this warranty shall be repair or replacement as provided above at the sole discretion of **NAWROOZ SURGICAL**. In no event will **NAWROOZ SURGICAL** be liable for any damages arising out of loss of use, or any other incidental or consequential damages. The foregoing limited warranty is in lieu of any other warranty with respect to **NAWROOZ SURGICAL** products. **NAWROOZ SURGICAL** grants no other warranty, express or implied

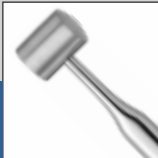
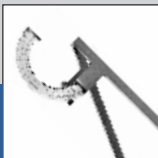
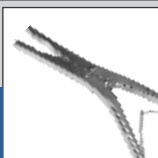
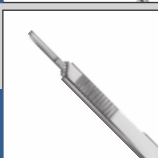
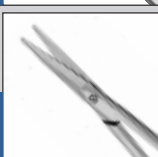
AREOLA MARKERS	2	
BREAST RETRACTORS	3-13	
DISSECTOR & ELEVATORS	14-26	
CHISELS & GOUGES	27-31	
OSTEOTOMES & RASPATORIES	32-46	
MUCOSA KNIFE & RASPATORIES	47	
RHINOPLASTY FILES & RASPS	48-51	
RHINOPLASTY FORCEPS	52-53	
RHINOPLASTY RETRACTORS	54-59	
RHINOPLASTY SAWS	60	
RHINOPLASTY SEPTUM FORCEPS	61	

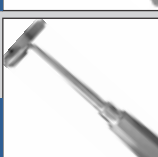
RHINOPLASTY SPECULA	62-64	
RHINOPLASTY KNIVES	65	
GRASPING FORCEPS & HOOK SCISSORS	66	
SEPTUM STRAIGHTENING FORCEPS	67-68	
MOUTH GAGS	69-70	
RETRACTORS	71-78	
CYLINDER OSTEOTOMES	79	
AURICULAR PLASTIC INSTRUMENTS	80	
CARTILAGE AND BONE INSTRUMENTS	81-83	
DERMATOMES	84	
LIPS AND CHEEKS RETRACTORS	85	

LIP AND CLEFT PALATE INSTRUMENTS	86-87	
MALLETS	88	
MARKING AND MEASURING INSTRUMENTS	89-92	
BONE INSTRUMENTS	93	
SCALPEL HANDLE	95	
SCISSORS	96-106	
DRESSING AND TISSUE FORCEPS	107-111	
HEMOSTATIC FORCEPS	112-114	
NEEDLE HOLDERS	115-120	
MICRO SURGERY INSTRUMENTS	121-123	



**GROSSMANN AREOLA MARKER**

Item Code	Description
<b>01-001-001</b>	40MM,44MM,48MM, 52MM



**FREEMAN AREOLA MARKER**

Item Code	Description
<b>01-002-001</b>	2 SIZES, 34MM / 36MM
<b>01-002-002</b>	2 SIZES, 38MM / 42MM
<b>01-002-003</b>	2 SIZES, 42MM / 45MM
<b>01-002-004</b>	2 SIZES, 45MM / 50MM



**FREEMAN AREOLA MARKER**

Item Code	Description
<b>01-003-001</b>	34MM
<b>01-003-002</b>	36MM
<b>01-003-003</b>	38MM
<b>01-003-004</b>	42MM
<b>01-003-005</b>	45MM
<b>01-003-006</b>	50MM



STAINLESS STEEL

**FREEMAN AREOLA MARKER**

Item Code	Description
<b>01-004-001</b>	38 MM
<b>01-004-002</b>	42 MM
<b>01-004-003</b>	50 MM
<b>01-004-004</b>	45 MM
<b>01-004-005</b>	34 MM
<b>01-004-006</b>	36 MM



**SOLZ AREOLA MARKER**

Item Code	Description
<b>01-005-001</b>	BLUNT, 36MM DIAMETER
<b>01-005-002</b>	BLUNT, 40MM DIAMETER
<b>01-005-003</b>	BLUNT, 42MM DIAMETER
<b>01-005-004</b>	BLUNT, 45MM DIAMETER





**MARX BREAST RETRACTOR**

Item Code	Description
<b>02-001-001</b>	27CM, 125 X 30MM
<b>02-001-002</b>	27CM, 140 X 30MM



**FERRIERA STYLE RETRACTOR**

Size	With Light Guide & Suction	With Light Guide	Retractor Only	Suction Only
70 X 16 mm	<b>02-002-001</b>	<b>02-003-001</b>	<b>02-004-001</b>	<b>02-005-001</b>
80 X 16 mm	<b>02-002-002</b>	<b>02-003-002</b>	<b>02-004-002</b>	<b>02-005-002</b>
90 X 27 mm	<b>02-002-003</b>	<b>02-003-003</b>	<b>02-004-003</b>	<b>02-005-003</b>
110 X 25 mm	<b>02-002-004</b>	<b>02-003-004</b>	<b>02-004-004</b>	<b>02-005-004</b>
120 X 25 mm	<b>02-002-005</b>	<b>02-003-005</b>	<b>02-004-005</b>	<b>02-005-005</b>
130 X 16 mm	<b>02-002-006</b>	<b>02-003-006</b>	<b>02-004-006</b>	<b>02-005-006</b>
130 X 25 mm	<b>02-002-007</b>	<b>02-003-007</b>	<b>02-004-007</b>	<b>02-005-007</b>
150 X 25 mm	<b>02-002-008</b>	<b>02-003-008</b>	<b>02-004-008</b>	<b>02-005-008</b>
150 X 30 mm	<b>02-002-009</b>	<b>02-003-009</b>	<b>02-004-009</b>	<b>02-005-009</b>
150 X 36 mm	<b>02-002-010</b>	<b>02-003-010</b>	<b>02-004-010</b>	<b>02-005-010</b>
180 X 16 mm	<b>02-002-011</b>	<b>02-003-011</b>	<b>02-004-011</b>	<b>02-005-011</b>
180 X 25 mm	<b>02-002-012</b>	<b>02-003-012</b>	<b>02-004-012</b>	<b>02-005-012</b>
190 X 25 mm	<b>02-002-013</b>	<b>02-003-013</b>	<b>02-004-013</b>	<b>02-005-013</b>
190 X 36 mm	<b>02-002-014</b>	<b>02-003-014</b>	<b>02-004-014</b>	<b>02-005-014</b>
220 X 27 mm	<b>02-002-015</b>	<b>02-003-015</b>	<b>02-004-015</b>	<b>02-005-015</b>

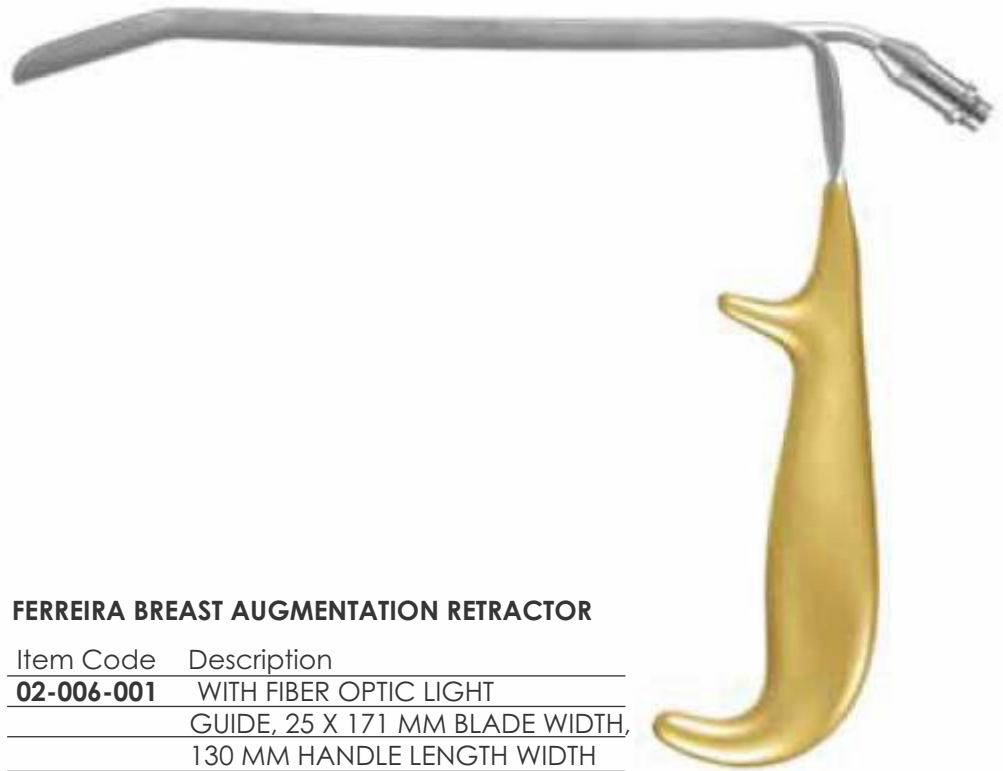

**FERREIRA BREAST AUGMENTATION RETRACTOR**

Item Code	Description
<b>02-006-001</b>	WITH FIBER OPTIC LIGHT GUIDE, 25 X 171 MM BLADE WIDTH, 130 MM HANDLE LENGTH WIDTH



**TEBBETTS RETRACTORS**

Size	With Light Guide & Suction	With Light Guide	Retractor Only	Suction Only
70 X 16 mm	<b>02-007-001</b>	<b>02-008-001</b>	<b>02-009-001</b>	<b>02-010-001</b>
80 X 16 mm	<b>02-007-002</b>	<b>02-008-002</b>	<b>02-009-002</b>	<b>02-010-002</b>
90 X 27 mm	<b>02-007-003</b>	<b>02-008-003</b>	<b>02-009-003</b>	<b>02-010-003</b>
110 X 25 mm	<b>02-007-004</b>	<b>02-008-004</b>	<b>02-009-004</b>	<b>02-010-004</b>
120 X 25 mm	<b>02-007-005</b>	<b>02-008-005</b>	<b>02-009-005</b>	<b>02-010-005</b>
130 X 16 mm	<b>02-007-006</b>	<b>02-008-006</b>	<b>02-009-006</b>	<b>02-010-006</b>
130 X 25 mm	<b>02-007-007</b>	<b>02-008-007</b>	<b>02-009-007</b>	<b>02-010-007</b>
150 X 25 mm	<b>02-007-008</b>	<b>02-008-008</b>	<b>02-009-008</b>	<b>02-010-008</b>
150 X 30 mm	<b>02-007-009</b>	<b>02-008-009</b>	<b>02-009-009</b>	<b>02-010-009</b>
150 X 36 mm	<b>02-007-010</b>	<b>02-008-010</b>	<b>02-009-010</b>	<b>02-010-010</b>
180 X 16 mm	<b>02-007-011</b>	<b>02-008-011</b>	<b>02-009-011</b>	<b>02-010-011</b>
180 X 25 mm	<b>02-007-012</b>	<b>02-008-012</b>	<b>02-009-012</b>	<b>02-010-012</b>
190 X 25 mm	<b>02-007-013</b>	<b>02-008-013</b>	<b>02-009-013</b>	<b>02-010-013</b>
190 X 36 mm	<b>02-007-014</b>	<b>02-008-014</b>	<b>02-009-014</b>	<b>02-010-014</b>
220 X 27 mm	<b>02-007-015</b>	<b>02-008-015</b>	<b>02-009-015</b>	<b>02-010-015</b>

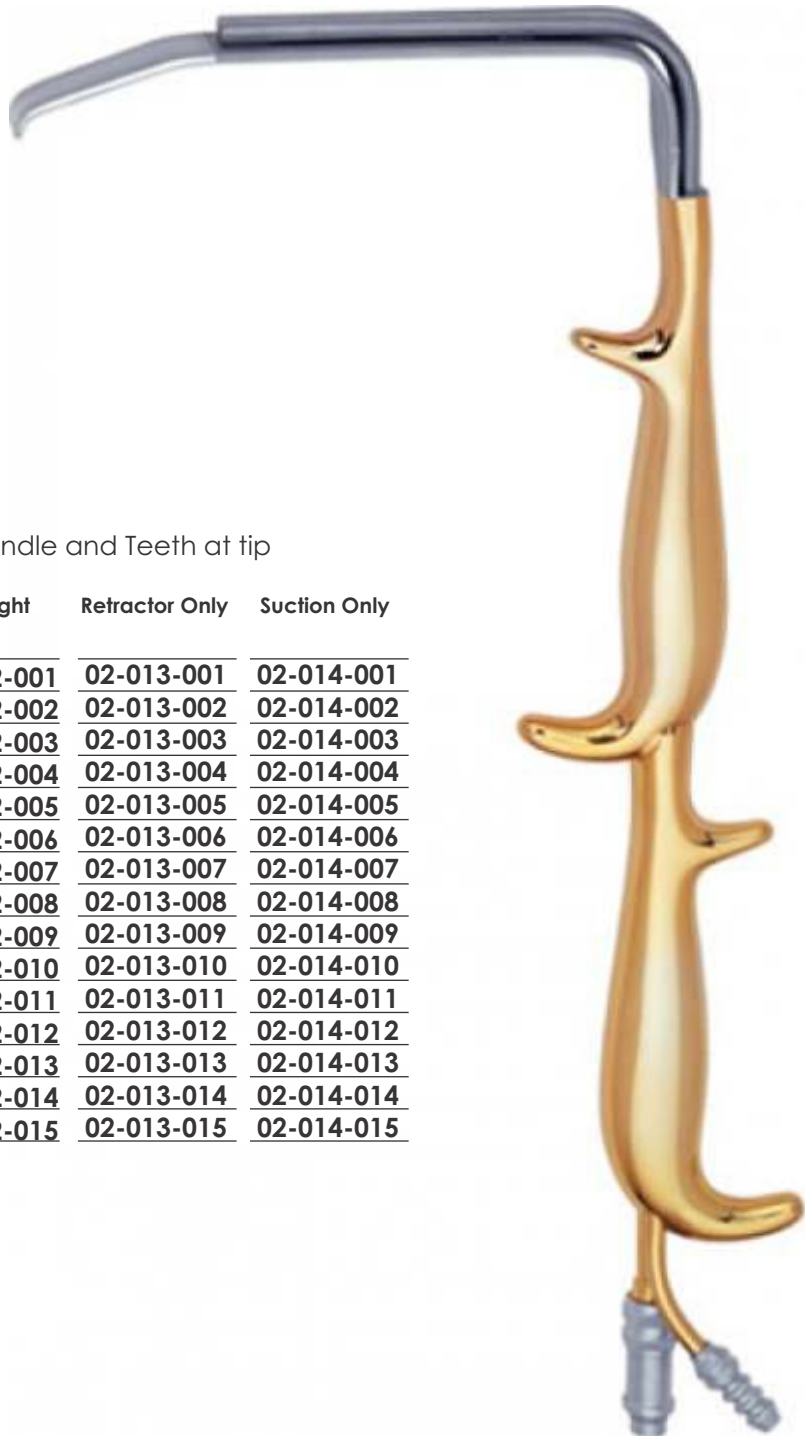

**TEBBETTS RETRACTOR**, With Double Handle and Teeth at tip

Size	With Light Guide & Suction	With Light Guide	Retractor Only	Suction Only
70 X 16 mm	<b>02-011-001</b>	<b>02-012-001</b>	<b>02-013-001</b>	<b>02-014-001</b>
80 X 16 mm	<b>02-011-002</b>	<b>02-012-002</b>	<b>02-013-002</b>	<b>02-014-002</b>
90 X 27 mm	<b>02-011-003</b>	<b>02-012-003</b>	<b>02-013-003</b>	<b>02-014-003</b>
110 X 25 mm	<b>02-011-004</b>	<b>02-012-004</b>	<b>02-013-004</b>	<b>02-014-004</b>
120 X 25 mm	<b>02-011-005</b>	<b>02-012-005</b>	<b>02-013-005</b>	<b>02-014-005</b>
130 X 16 mm	<b>02-011-006</b>	<b>02-012-006</b>	<b>02-013-006</b>	<b>02-014-006</b>
130 X 25 mm	<b>02-011-007</b>	<b>02-012-007</b>	<b>02-013-007</b>	<b>02-014-007</b>
150 X 25 mm	<b>02-011-008</b>	<b>02-012-008</b>	<b>02-013-008</b>	<b>02-014-008</b>
150 X 30 mm	<b>02-011-009</b>	<b>02-012-009</b>	<b>02-013-009</b>	<b>02-014-009</b>
150 X 36 mm	<b>02-011-010</b>	<b>02-012-010</b>	<b>02-013-010</b>	<b>02-014-010</b>
180 X 16 mm	<b>02-011-011</b>	<b>02-012-011</b>	<b>02-013-011</b>	<b>02-014-011</b>
180 X 25 mm	<b>02-011-012</b>	<b>02-012-012</b>	<b>02-013-012</b>	<b>02-014-012</b>
190 X 25 mm	<b>02-011-013</b>	<b>02-012-013</b>	<b>02-013-013</b>	<b>02-014-013</b>
190 X 36 mm	<b>02-011-014</b>	<b>02-012-014</b>	<b>02-013-014</b>	<b>02-014-014</b>
220 X 27 mm	<b>02-011-015</b>	<b>02-012-015</b>	<b>02-013-015</b>	<b>02-014-015</b>

**TEBBETTS RETRACTOR**, Insulated Blade with Teeth

Size	With Light Guide & Suction	With Light Guide	Retractor Only	Suction Only
70 X 16 mm	02-015-001	02-016-001	02-017-001	02-018-001
80 X 16 mm	02-015-002	02-016-002	02-017-002	02-018-002
90 X 27 mm	02-015-003	02-016-003	02-017-003	02-018-003
110 X 25 mm	02-015-004	02-016-004	02-017-004	02-018-004
120 X 25 mm	02-015-005	02-016-005	02-017-005	02-018-005
130 X 16 mm	02-015-006	02-016-006	02-017-006	02-018-006
130 X 25 mm	02-015-007	02-016-007	02-017-007	02-018-007
150 X 25 mm	02-015-008	02-016-008	02-017-008	02-018-008
150 X 30 mm	02-015-009	02-016-009	02-017-009	02-018-009
150 X 36 mm	02-015-010	02-016-010	02-017-010	02-018-010
180 X 16 mm	02-015-011	02-016-011	02-017-011	02-018-011
180 X 25 mm	02-015-012	02-016-012	02-017-012	02-018-012
190 X 25 mm	02-015-013	02-016-013	02-017-013	02-018-013
190 X 36 mm	02-015-014	02-016-014	02-017-014	02-018-014
220 X 27 mm	02-015-015	02-016-015	02-017-015	02-018-015

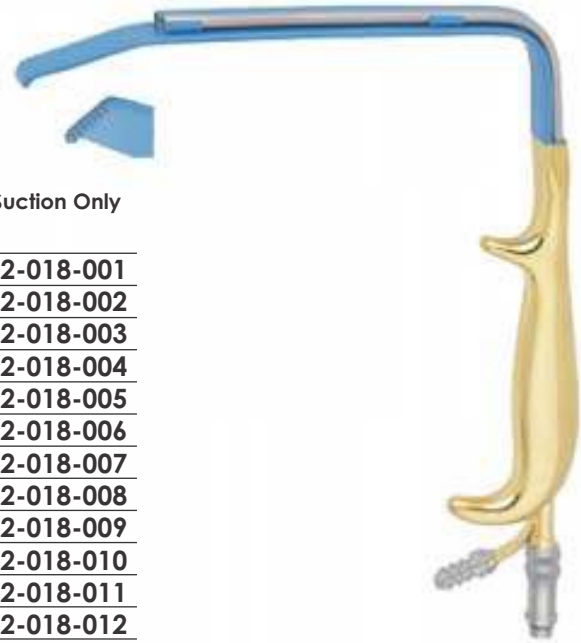

**Tebbetts Breast Augmentation Fiber Optic Retractor**, Insulated Blade With Smooth End

Size	With Light Guide & Suction	With Light Guide	Retractor Only	Suction Only
70 X 16 mm	02-019-001	02-020-001	02-021-001	02-022-001
80 X 16 mm	02-019-002	02-020-002	02-021-002	02-022-002
90 X 27 mm	02-019-003	02-020-003	02-021-003	02-022-003
110 X 25 mm	02-019-004	02-020-004	02-021-004	02-022-004
120 X 25 mm	02-019-005	02-020-005	02-021-005	02-022-005
130 X 16 mm	02-019-006	02-020-006	02-021-006	02-022-006
130 X 25 mm	02-019-007	02-020-007	02-021-007	02-022-007
150 X 25 mm	02-019-008	02-020-008	02-021-008	02-022-008
150 X 30 mm	02-019-009	02-020-009	02-021-009	02-022-009
150 X 36 mm	02-019-010	02-020-010	02-021-010	02-022-010
180 X 16 mm	02-019-011	02-020-011	02-021-011	02-022-011
180 X 25 mm	02-019-012	02-020-012	02-021-012	02-022-012
190 X 25 mm	02-019-013	02-020-013	02-021-013	02-022-013
190 X 36 mm	02-019-014	02-020-014	02-021-014	02-022-014
220 X 27 mm	02-019-015	02-020-015	02-021-015	02-022-015



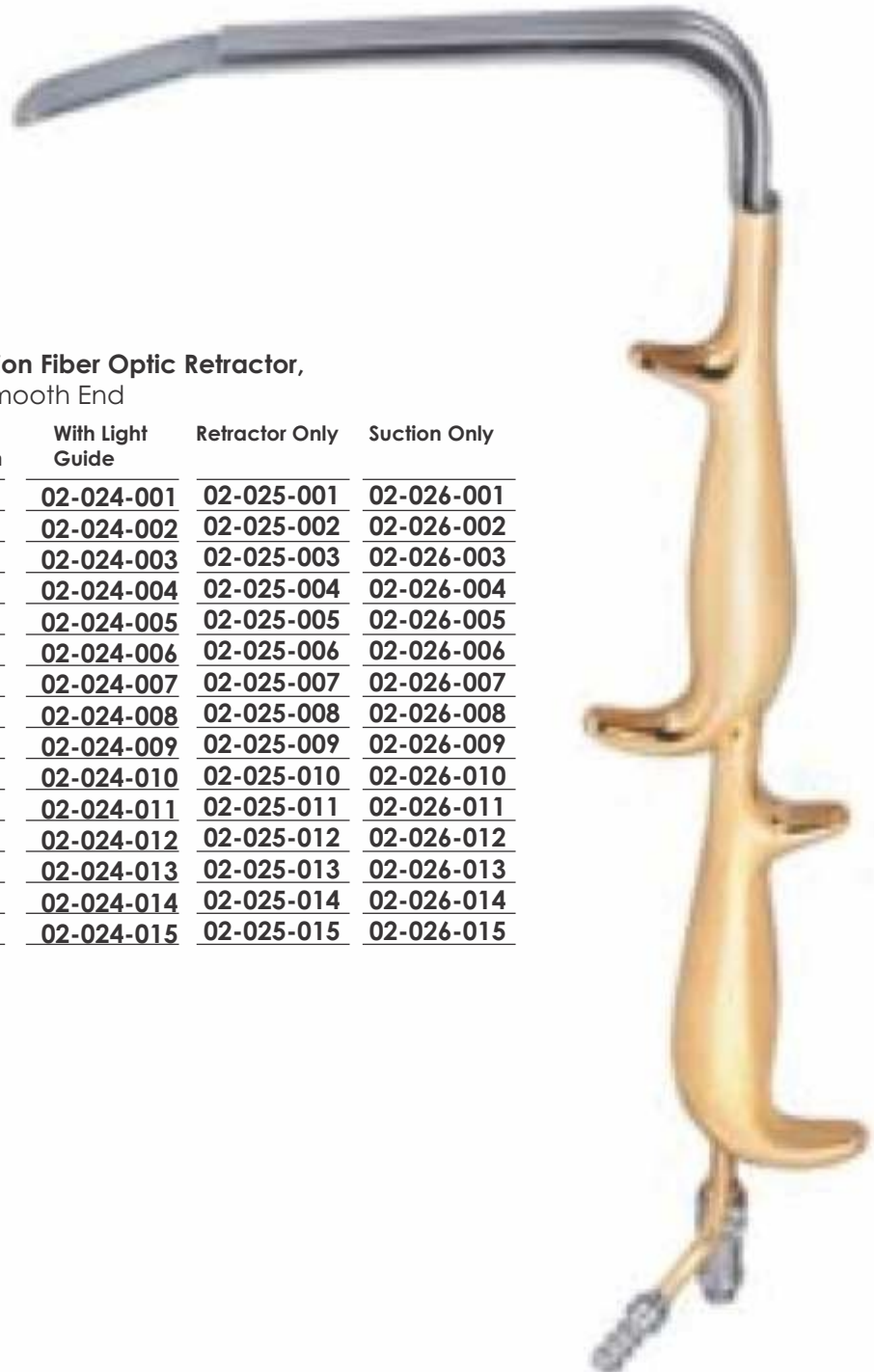

**Tebbetts Breast Augmentation Fiber Optic Retractor,**  
With Double Handle and Smooth End

Size	With Light Guide & Suction	With Light Guide	Retractor Only	Suction Only
70 X 16 mm	<b>02-023-001</b>	<b>02-024-001</b>	<b>02-025-001</b>	<b>02-026-001</b>
80 X 16 mm	<b>02-023-002</b>	<b>02-024-002</b>	<b>02-025-002</b>	<b>02-026-002</b>
90 X 27 mm	<b>02-023-003</b>	<b>02-024-003</b>	<b>02-025-003</b>	<b>02-026-003</b>
110 X 25 mm	<b>02-023-004</b>	<b>02-024-004</b>	<b>02-025-004</b>	<b>02-026-004</b>
120 X 25 mm	<b>02-023-005</b>	<b>02-024-005</b>	<b>02-025-005</b>	<b>02-026-005</b>
130 X 16 mm	<b>02-023-006</b>	<b>02-024-006</b>	<b>02-025-006</b>	<b>02-026-006</b>
130 X 25 mm	<b>02-023-007</b>	<b>02-024-007</b>	<b>02-025-007</b>	<b>02-026-007</b>
150 X 25 mm	<b>02-023-008</b>	<b>02-024-008</b>	<b>02-025-008</b>	<b>02-026-008</b>
150 X 30 mm	<b>02-023-009</b>	<b>02-024-009</b>	<b>02-025-009</b>	<b>02-026-009</b>
150 X 36 mm	<b>02-023-010</b>	<b>02-024-010</b>	<b>02-025-010</b>	<b>02-026-010</b>
180 X 16 mm	<b>02-023-011</b>	<b>02-024-011</b>	<b>02-025-011</b>	<b>02-026-011</b>
180 X 25 mm	<b>02-023-012</b>	<b>02-024-012</b>	<b>02-025-012</b>	<b>02-026-012</b>
190 X 25 mm	<b>02-023-013</b>	<b>02-024-013</b>	<b>02-025-013</b>	<b>02-026-013</b>
190 X 36 mm	<b>02-023-014</b>	<b>02-024-014</b>	<b>02-025-014</b>	<b>02-026-014</b>
220 X 27 mm	<b>02-023-015</b>	<b>02-024-015</b>	<b>02-025-015</b>	<b>02-026-015</b>



**Sculpo Breast Retractors**

Item Code	Description
<b>02-027-001</b>	180 X 25mm, Blade Size, With 5mm Endoscopic Scope Sheath
<b>02-027-002</b>	180 X 25mm, Blade Size, With 10mm Endoscopic Scope Sheath



**Ring breast retractor**

Item Code	Description
<b>02-028-001</b>	with fiber optic illumination and irrigation tube



**BIGGS MAMMAPLASTY RETRACTOR**

Item Code	Description
<b>02-029-001</b>	WITH FIBER OPTIC LIGHT GUIDE 5.0 CM BLADE WIDTH, 20 CM LENGTH



**BIGGS MAMMAPLASTY RETRACTOR,**

Item Code	Description
<b>02-030-001</b>	3 CM BLADE WIDTH, NARROW, (171 MM) LENGTH

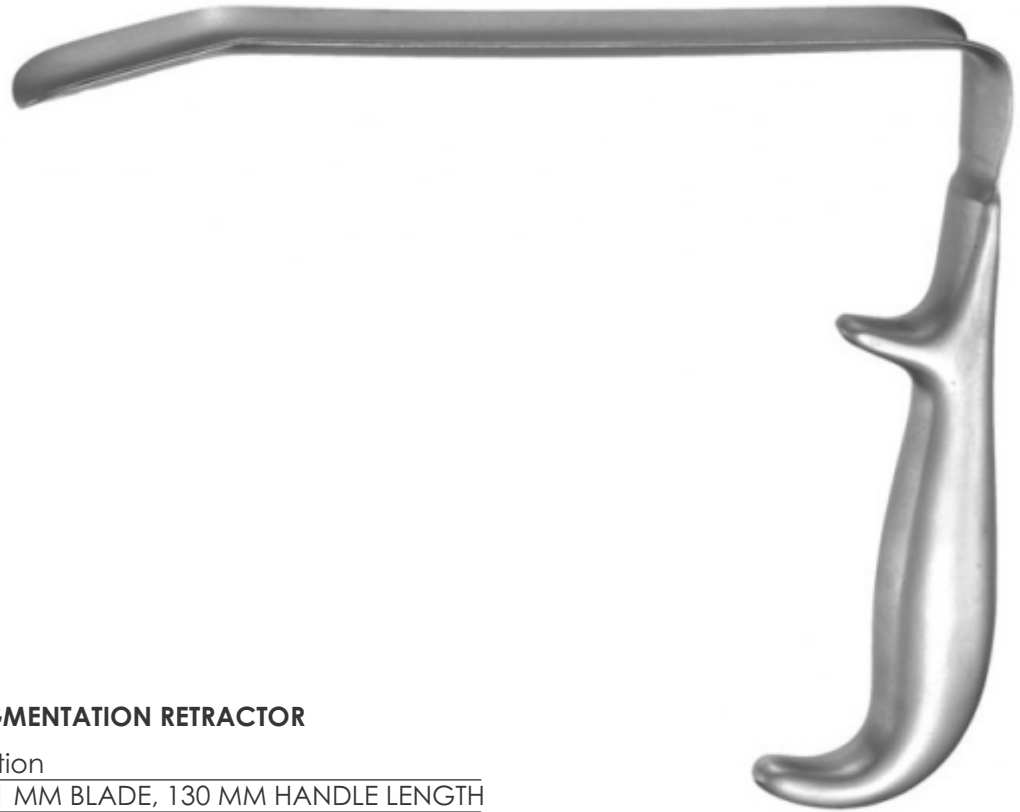

**FERREIRA BREAST AUGMENTATION RETRACTOR**

Item Code	Description
<b>02-031-001</b>	25 X 171 MM BLADE, 130 MM HANDLE LENGTH

**BIGGS MAMMAPLASTY RETRACTOR**

Item Code	Description
<b>02-032-001</b>	WITH FIBER OPTIC LIGHT GUIDE, NARROW, 3.0 CM BLADE WIDTH, 15 CM LENGTH







**BIGGS MAMMAPLASTY RETRACTOR**

Item Code	Description
<b>02-033-001</b>	50 MM WIDTH, STANDARD, 20 CM LENGTH



**BREAST RETRACTOR**

Item Code	Description
<b>02-034-001</b>	DOUBLE ENDED, (31 CM), BLADES 22MM X 55MM AND 38MM X 70MM
<b>02-034-002</b>	DOUBLE ENDED, (24 CM), BLADES 22MM X 55MM AND 38MM X 70MM



**BIGGS MAMMAPLASTY RETRACTORS**

Item Code	Description
<b>02-035-001</b>	30MM, WITH FIBER OPTIC LIGHT GUIDE
<b>02-035-002</b>	50MM, WITH FIBER OPTIC LIGHT GUIDE
<b>02-035-003</b>	30MM, WITH FIBER OPTIC LIGHT GUIDE AND SUCTION
<b>02-035-004</b>	50MM, WITH FIBER OPTIC LIGHT GUIDE AND SUCTION



**WIEDER BREAST AND FACIAL RETRACTOR / TONGUE  
DEPRESSOR, WITH FIBER OPTIC LIGHT GUIDE**

Item Code	Description
<b>02-036-001</b>	SERRATED, (14 CM), 28MM
<b>02-036-002</b>	SERRATED, (14 CM), 38MM
<b>02-036-003</b>	SERRATED, (15 CM), 45MM



**BREAST SPATULA**

Item Code	Description
<b>02-037-001</b>	WITH HANDLE 31.5 CM, 25MM X 18 CM BLADE, SERRATED TIP, SEMI MALLABLE



**WIEDER BREAST AND FACIAL RETRACTOR /  
TONGUE DEPRESSOR**

Item Code	Description
<b>02-038-001</b>	SERRATED, (14 CM), 28MM
<b>02-038-002</b>	SERRATED, (14 CM), 38MM
<b>02-038-003</b>	SERRATED, (15 CM), 45MM



**MACCOLLUM DINGMAN BREAST DISSECTOR**

Item Code	Description
<b>03-001-001</b>	31.5 CM
<b>03-001-002</b>	41 CM



**MACCOLLUM DINGMAN SUBMAMMARY DISSECTOR**

Item Code	Description
<b>03-002-001</b>	30 CM



**MACCOLLUM DINGMAN BREAST DISSECTOR**

Item Code	Description
<b>03-003-001</b>	1½" (38 MM) WIDTH, 17½" (432 MM) LENGTH



**BREAST DISSECTOR**

Item Code	Description
<b>03-004-001</b>	SPATULATED BLADE, 33CM
<b>03-004-002</b>	SPATULATED BLADE, 42CM



**BREAST DISSECTOR**

Item Code	Description
<b>03-005-001</b>	OVAL SPATULATED BLADE, 33CM
<b>03-005-002</b>	OVAL SPATULATED BLADE, 42CM



**BREAST DISSECTOR**

Item Code	Description
<b>03-006-001</b>	ANGULATED BLADE, 33CM
<b>03-006-002</b>	ANGULATED BLADE, 42CM



**REYNOLDS TRANSAUXILLARY BREAST DISSECTOR**

Item Code	Description
<b>03-007-001</b>	FENESTRATED, 33CM
<b>03-007-002</b>	FENESTRATED, 40CM



**SILVERSTEIN BREAST DISSECTOR**

Item Code	Description
<b>03-008-001</b>	14" (356 MM) LENGTH



**SPATULA BREAST RETRACTOR / DISSECTOR**

Item Code	Description
<b>03-009-001</b>	SERRATED, 12½", SEMI MALLEABLE



**PENN BREAST DISSECTOR**

Item Code	Description
<b>03-010-001</b>	STRAIGHT, 1" (25 MM) WIDTH, 12¾" (324 MM) LENGTH



**MCINNIS POLYCURETTE BREAST INSTRUMENT**

Item Code	Description
<b>03-011-001</b>	11 <sup>3</sup> / <sub>4</sub> " (300 MM) WIDTH, 12 <sup>1</sup> / <sub>2</sub> " (318 MM) LENGTH



**JACOBS TRANSAXILLARY DISSECTOR**

Item Code	Description
<b>03-012-001</b>	CURVED SHAFT CHISEL EDGE 17" (432 mm) WIDTH 1/2" (13mm)



**WIESLANDER TRANSAXILLARY BREAST DISSECTOR**

Item Code	Description
<b>03-013-001</b>	LENGTH 18 1/8" (460mm) WIDTH 1" (25mm)
<b>03-013-002</b>	LENGTH 17" (432mm) WIDTH 1-3/8" (35mm)



**REYNOLDS TRANSAXILLARY BREAST DISSECTOR**

Item Code	Description
<b>03-014-001</b>	15 3/4" (400mm) 1 1/2" (38mm)



**TROCAR BREAST TUBE**

Item Code	Description
<b>03-015-001</b>	14" (356 MM), LARGE, 17.3 MM ID, 19.0 MM OD
<b>03-015-002</b>	13 1/2" (343MM), SMALL, 14 MM ID, 16 MM OD



**SOLZ ATRAUMATIC BREAST DISSECTOR**

Item Code	Description
<b>03-016-001</b>	34CM
<b>03-016-002</b>	37CM



**SOLZ BREAST HOOK DISSECTOR**

Item Code	Description
<b>03-017-001</b>	36CM



**AGRIS DINGMAN BREAST DISSECTOR**

Item Code	Description
<b>03-018-001</b>	SET OF 2, LEFT AND RIGHT, 36CM



**ICONOCLAST**

Item Code	Description
<b>03-019-001</b>	LARGE, 11½" (292 MM) LENGTH, 5¾" (146 MM) BLADE
<b>03-019-002</b>	SMALL, 8¾" (222 MM) LENGTH, 3¼" (83 MM) BLADE



<u>Item Code</u>	<u>Description</u>
<b>03-020-001</b>	<b>BREAST ELEVATOR FOR MAMMARY PLASTY</b>



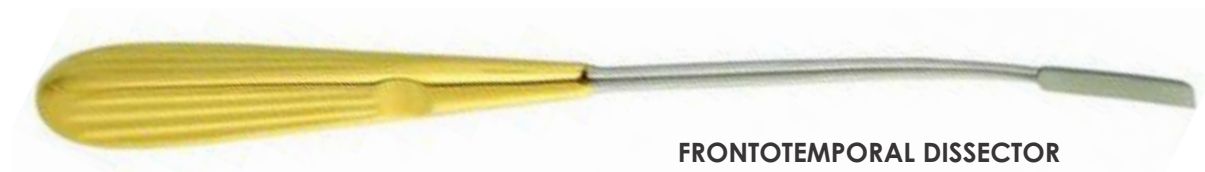

**FRONTOTEMPORAL DISSECTOR**

Item Code Description

**03-021-001** 9" (22.5 CM), 5MM TIP, SLIGHTLY CURVED

**03-021-002** 9" (23 CM), 7MM TIP, SLIGHTLY CURVED

**03-021-003** 9" (23 CM), 10MM TIP, SLIGHTLY CURVED



**FLAP DISSECTOR**

Item Code Description

**03-022-001** 9½" (23.5 CM), 5MM TIP, STRAIGHT



**TEMPORAL T DISSECTOR**

Item Code Description

**03-023-001** 9½" (23.5 CM), 12MM TIP, STRAIGHT



**FRONTOGLABELLAR DISSECTOR**

Item Code Description

**03-024-001** 10½" (26.5 CM), 7MM TIP, S SHAPED

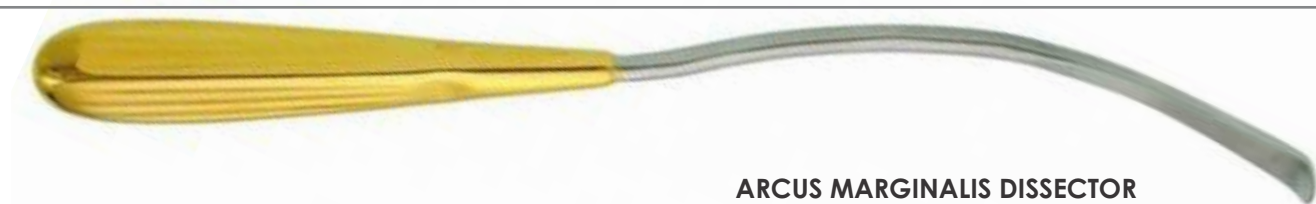

**ARCUS MARGINALIS DISSECTOR**

Item Code Description

**03-025-001** 9 3/4" (24 CM), 10MM TIP, S SHAPED



**MIDFACE FACIAL DISSECTOR,**

Item Code	Description
<b>03-026-001</b>	9 <sup>3</sup> / <sub>4</sub> " (24 CM), MULTIPLE CURVES, 12MM WIDE TIP



**ORBITAL RIM DISSECTOR**

Item Code	Description
<b>03-027-001</b>	9" (22.5 CM), SLIGHTLY CURVED



**TRANSORAL DISSECTOR**

Item Code	Description
<b>03-028-001</b>	9 <sup>3</sup> / <sub>4</sub> " (23.5 CM), CURVED TIP



**ZYGOMATIC ARCH ELEVATOR**

Item Code	Description
<b>03-029-001</b>	8 <sup>1</sup> / <sub>4</sub> " (20.5 CM), STRAIGHT BLADE, 5MM



**SCALP ELEVATOR**

Item Code	Description
<b>03-030-001</b>	9 3/4" (24 CM), 12.5MM TIP, SLIGHTLY CURVED
<b>03-030-002</b>	9 3/4" (24 CM), 15MM TIP, SLIGHTLY CURVED
<b>03-030-003</b>	9 3/4" (24 CM), 7MM TIP, STRAIGHT
<b>03-030-004</b>	9 3/4" (24 CM), 12.5MM TIP, S SHAPED
<b>03-030-005</b>	9 3/4" (24 CM), 12.5MM TIP, SLIGHTLY CURVED
<b>03-030-006</b>	9 3/4" (24 CM), 7MM TIP, CURVED TIP
<b>03-030-007</b>	9 3/4" (24 CM), 7MM TIP, STRONGLY CURVED
<b>03-030-008</b>	9 3/4" (24 CM), 7MM TIP, SLIGHTLY CURVED



**SCALP ELEVATOR WITH SUCTION**

Item Code	Description
<b>03-031-001</b>	9¾" (24 CM), 7MM WIDE TIP, SLIGHTLY CURVED



**SCALP ELEVATOR WITH SUCTION**

Item Code	Description
<b>03-032-001</b>	10½" (26 CM), 8.5 MM WIDE TIP, CURVED TIP



**PERIOSTEAL ELEVATOR**

<b>03-033-001</b>	10" (25 CM), S SHAPED
-------------------	-----------------------



**PERIOSTEAL SPREADER**

Item Code	Description
<b>03-034-001</b>	9¾" (24 CM), 8MM TIP, S SHAPED



**PERIOSTEAL SPREADER**

Item Code	Description
<b>03-035-001</b>	9¾" (24 CM), 10MM WIDE BLADE, S SHAPED



**HALLE SEPTUM ELEVATOR**

Item Code	Description
03-036-001	NARROW, 3 MM WIDTH, 7" (178 MM) LENGTH



**FREER SEPTUM ELEVATOR**

Item Code	Description
03-037-001	DOUBLE ENDED, SHARP / BLUNT, WIDE, 6.5 MM WIDTH, 7¾" (197 MM) LENGTH



**HAJEK BALLENGER SEPTUM ELEVATOR**

Item Code	Description
03-038-001	DOUBLE ENDED, 8.5 MM WIDTH, 7½" (191 MM) LENGTH



**FREER SEPTUM ELEVATOR**

Item Code	Description
03-039-001	CURVED, DOUBLE ENDED, 5 MM WIDTH, 7½" (191 MM) LENGTH



**KILLIAN SEPTUM ELEVATOR**

Item Code	Description
03-040-001	DOUBLE ENDED, 4 MM WITH 3.4 MM TAPER, AND 4.3 MM WITH 3 MM TAPER, 7¼" (184 MM) LENGTH

**NAGATA AURICULAR SEPTUM**

Item Code	Description
03-041-001	ELEVATOR, 16CM, BLUNT
03-041-002	ELEVATOR, 17CM, BLUNT

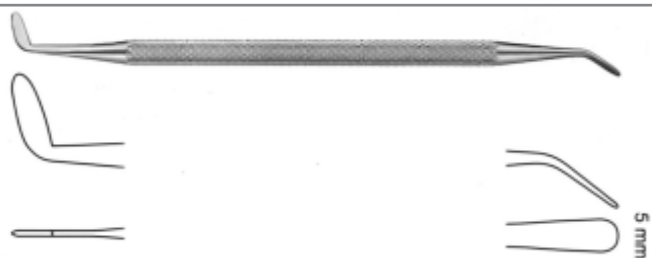



**LANGENBECK BONE ELEVATOR**

Item Code	Description
<b>03-042-001</b>	23CM, 10MM, BLUNT, STRONG CURVE



**FREER PERIOSTEAL ELEVATOR**

Item Code	Description
<b>03-043-001</b>	19CM, 5MM, DOUBLE ENDED, SHARP / BLUNT
<b>03-043-002</b>	19CM, 6.5MM, DOUBLE ENDED, SHARP / BLUNT

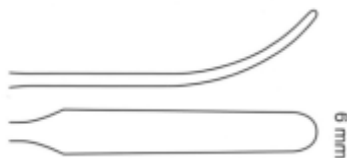

**COHEN PERIOSTEAL ELEVATOR / RETRACTOR**

Item Code	Description
<b>03-044-001</b>	24CM, 6MM, DOUBLE ENDED, BLUNT



**PENNINGTON SEPTUM ELEVATOR**

Item Code	Description
<b>03-045-001</b>	20CM, DOUBLE ENDED



**YANKAUER SEPTUM ELEVATOR**

Item Code	Description
<b>03-046-001</b>	18CM, 6MM, BLUNT



**COTTLE PERIOSTEAL ELEVATOR**

Item Code	Description
<b>03-047-001</b>	18CM, 8MM, BLUNT

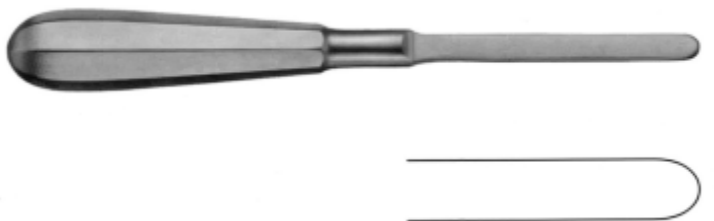

**BOIES NASAL FRACTURE ELEVATOR**

Item Code	Description
<b>03-048-001</b>	19CM, 8MM, BLUNT



**GOLDMAN SEPTUM FRACTURE ELEVATOR,**

Item Code	Description
<b>03-049-001</b>	17CM, 5MM, BLUNT

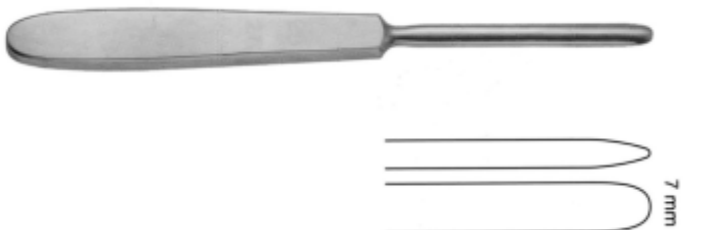

**NASAL FRACTURE ELEVATOR**

Item Code	Description
<b>03-050-001</b>	17CM, 7MM, BLUNT



**SUCTION ELEVATOR WITH GUIDE**

Item Code	Description
<b>03-051-001</b>	21CM, 4MM



**COTTLE PERIOSTEAL ELEVATOR**

Item Code	Description
<b>03-052-001</b>	20CM, 2/4MM, DOUBLE ENDED, FINE
<b>03-052-002</b>	23CM, 3/4MM, DOUBLE ENDED



**MASING SEPTUM ELEVATOR**

Item Code	Description
<b>03-053-001</b>	22CM, 5/5MM, DOUBLE ENDED

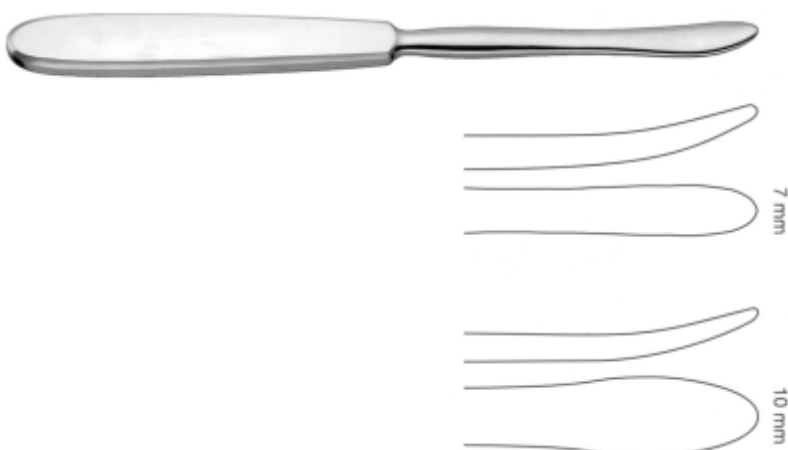

**LANGENBECK BONE ELEVATOR**

Item Code	Description
<b>03-054-001</b>	20CM, 7MM, BLUNT
<b>03-054-002</b>	20CM, 10MM, BLUNT



**HOWARTH SEPTUM ELEVATOR**

Item Code Description

**03-055-001** DOUBLE ENDED, 5 MM WIDTH, 8½"  
(216 MM) LENGTH



**KILLIAN SEPTUM ELEVATOR**

Item Code Description

**03-056-001** DOUBLE ENDED, 9" (229 MM) LENGTH,  
6 MM WITH 4.5 MM TAPER AND 4.3 MM  
WITH 3 MM TAPER





**GRADUATED CHISELS**

Item Code	Description
<b>04-005-003</b>	17.8CM, 3.8MM



**GRADUATED CHISELS**

Item Code	Description
<b>04-005-004</b>	17.8CM, 3.8MM



**GRADUATED CHISELS**

Item Code	Description
<b>04-005-005</b>	17.8CM, 7.5MM



**GRADUATED CHISELS**

Item Code	Description
<b>04-005-006</b>	17.8CM, 7.5MM



4 mm



6 mm

**FREER SEPTUM CHISEL**

Item Code	Description
<b>04-001-001</b>	15.5CM, 4MM
<b>04-001-002</b>	15.5CM, 6MM



4 mm



6 mm

**BALLENGER SEPTUM CHISEL**

Item Code	Description
<b>04-002-001</b>	16CM, 4MM
<b>04-002-002</b>	16CM, 6MM



6 mm

**KILLIAN NASAL GOUGE**

Item Code	Description
<b>04-003-001</b>	17.5CM, 6MM



6 mm

**KILLIAN CLAUS NASAL GOUGE**

Item Code	Description
<b>04-004-001</b>	17CM, 6MM



**COTTLE GUBISCH CHISEL**

Item Code	Description
<b>04-005-001</b>	18CM, 5MM, GRADUATED, HOLLOW CUT
<b>04-005-002</b>	18CM, 12MM, GRADUATED, HOLLOW CUT

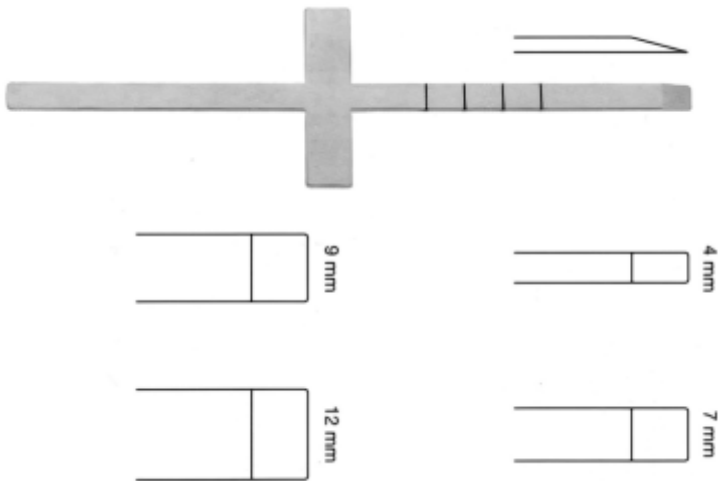

**COTTLE CHISEL**

Item Code	Description
<b>04-006-001</b>	18CM, 4MM, CROSS BAR, GRADUATED
<b>04-006-002</b>	18CM, 7MM, CROSS BAR, GRADUATED
<b>04-006-003</b>	18CM, 9MM, CROSS BAR, GRADUATED
<b>04-006-004</b>	18CM, 12MM, CROSS BAR, GRADUATED

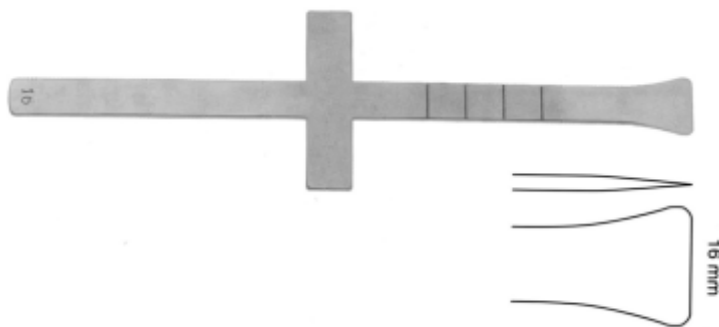

**COTTLE CHISEL**

Item Code	Description
<b>04-007-001</b>	18CM, 16MM, FISHTAIL SHAPED END, CROSSBAR,

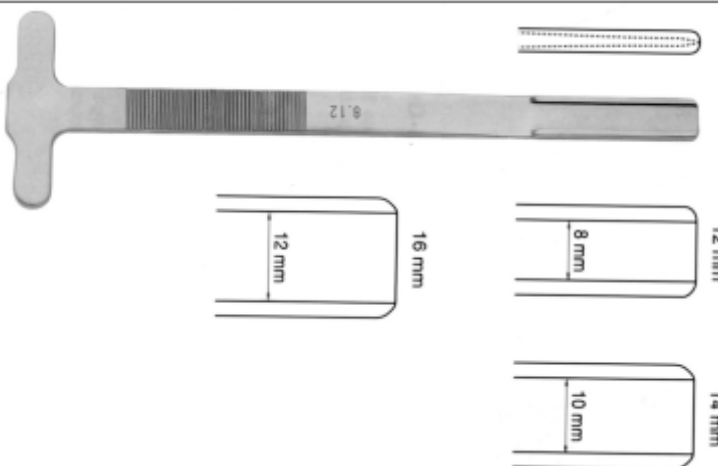

**RUBIN EDGED BONE CHISEL**

Item Code	Description
<b>04-008-001</b>	18CM, 8/12MM, T SHAPE
<b>04-008-002</b>	18CM, 10/14MM, T SHAPE
<b>04-008-003</b>	18CM, 12/16MM, T SHAPE

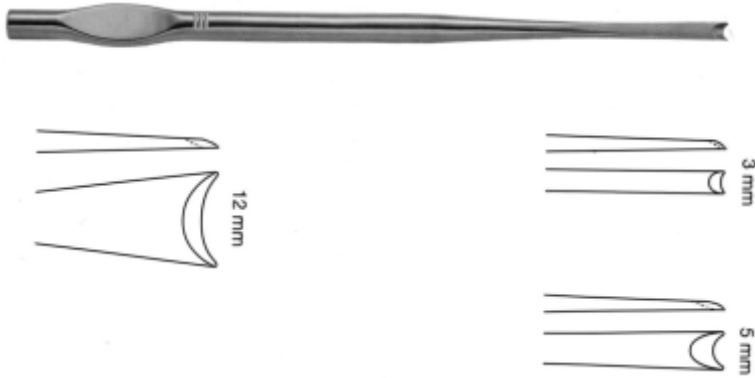

**WALTER CHISEL/OSTEOTOME**

Item Code	Description
04-009-001	19CM, 3MM, MODIFIED
04-009-002	19CM, 5MM, MODIFIED
04-009-003	19CM, 12MM, MODIFIED

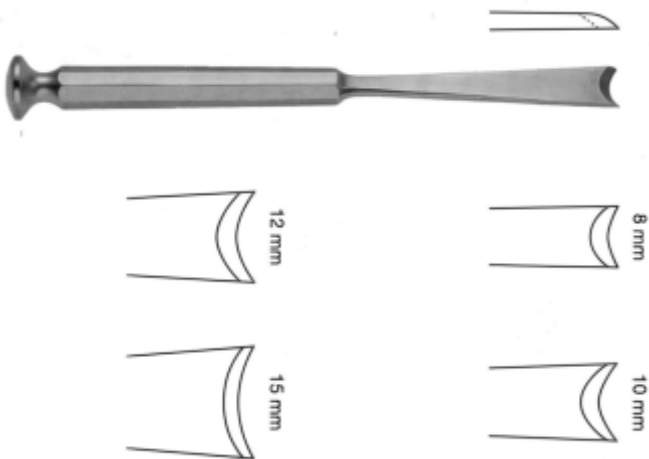

**MCINDOE CHISEL**

Item Code	Description
04-010-001	16CM, 8MM
04-010-002	16CM, 10MM
04-010-003	16CM, 12MM
04-010-004	16CM, 15MM

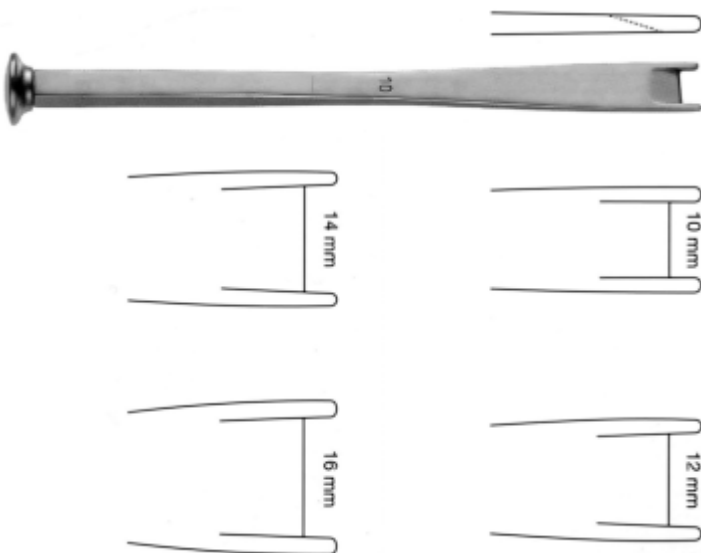

**MOBERG CHISEL**

Item Code	Description
04-011-001	18CM, 10MM
04-011-002	18CM, 12MM
04-011-003	18CM, 14MM
04-011-004	18CM, 16MM



**BRAITHWAITE NASAL CHISEL**

Item Code	Description
<b>04-011-001</b>	RIGHT, 5 MM WIDTH, 5 1/2" (140 MM)
<b>04-011-002</b>	LEFT, 5 MM WIDTH, 5 1/2" (140 MM)



**CLODIUS BONE CHISEL**

Item Code	Description
<b>04-012-001</b>	6 MM WIDTH, 8 3/4" (222 MM) LENGTH
	8 MM WIDTH, 8 3/4" (222 MM) LENGTH
	10 MM WIDTH, 8 3/4" (222 MM) LENGTH
	20 MM WIDTH, 8 3/4" (222 MM) LENGTH

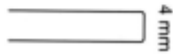

**COTTLE OSTEOTOME, 18CM**

Item Code Description

<b>05-001-001</b>	4MM, STRAIGHT, GRADUATED
<b>05-001-002</b>	7MM, STRAIGHT, GRADUATED
<b>05-001-003</b>	9MM, STRAIGHT, GRADUATED
<b>05-001-004</b>	12MM, STRAIGHT, GRADUATED



**GUBISCH OSTEOTOME**

Item Code Description

<b>05-002-001</b>	18.5CM, 3MM, ALUMINIUM HANDLE
-------------------	-------------------------------



**COTTLE OSTEOTOME, 18CM**

Item Code Description

<b>05-003-001</b>	16MM, FISHTAIL SHAPED END, STRAIGHT, GRADUATED
-------------------	--



**RUBIN NASAL OSTEOTOME, 18CM**

Item Code Description

<b>05-004-001</b>	10MM
<b>05-004-002</b>	14MM



**COTTLE OSTEOTOME, 18CM**

Item Code Description  
**05-005-001** 6MM, CURVED, GRADUATED



**COTTLE BONE LEVER/SPLITTING OSTEOTOME,**

Item Code Description  
**05-006-001** 20CM, 10MM



**GUBISCH FANOUS NASAL OSTEOTOME**

Item Code Description  
**05-007-001** 19.5CM, NARROW, DELICATE,  
 WITH GUIDE THORN

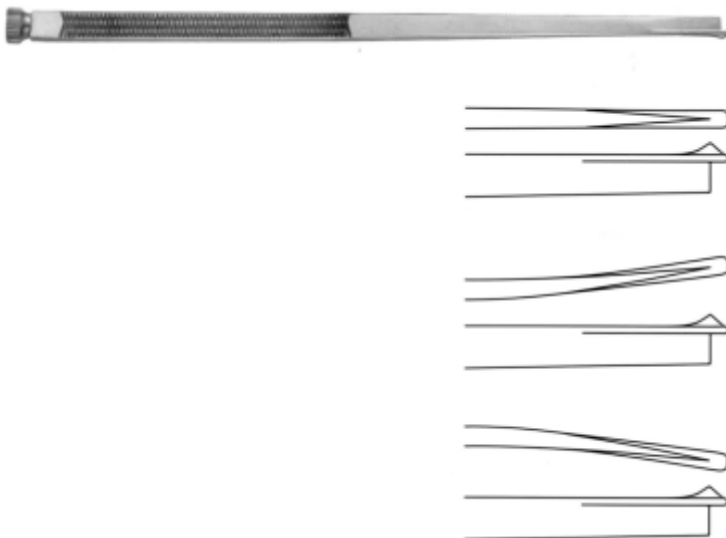

**FANOUS OSTEOTOME, 19.5CM**

Item Code Description  
**05-008-001** 4MM, STRAIGHT, WITH GUIDE THORN  
**05-008-002** 4MM, LEFT, WITH GUIDE THORN  
**05-008-003** 4MM, RIGHT, WITH GUIDE THORN

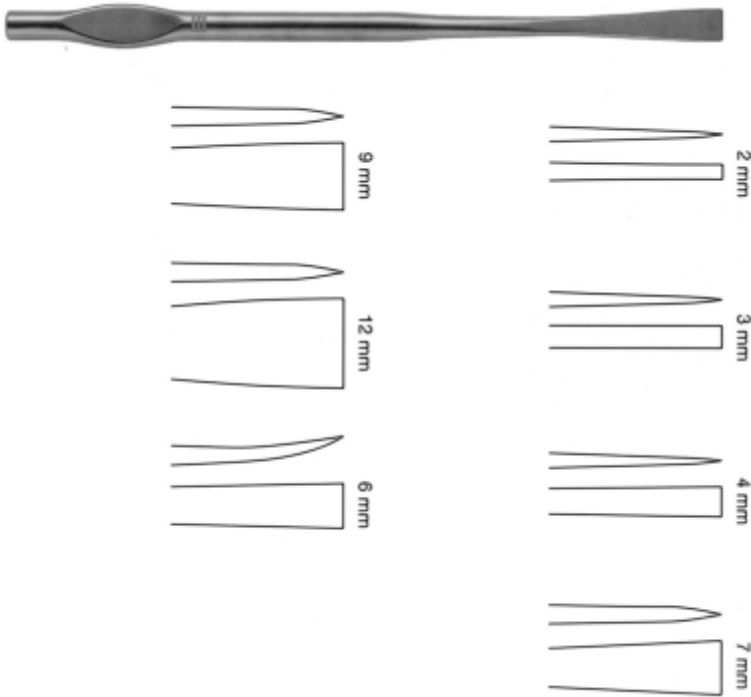

**WALTER OSTEOTOME, 19CM**

Item Code	Description
<b>05-009-001</b>	2MM
<b>05-009-002</b>	3MM
<b>05-009-003</b>	4MM
<b>05-009-004</b>	7MM
<b>05-009-005</b>	9MM,
<b>05-009-006</b>	12MM,
<b>05-009-007</b>	6MM, CURVED

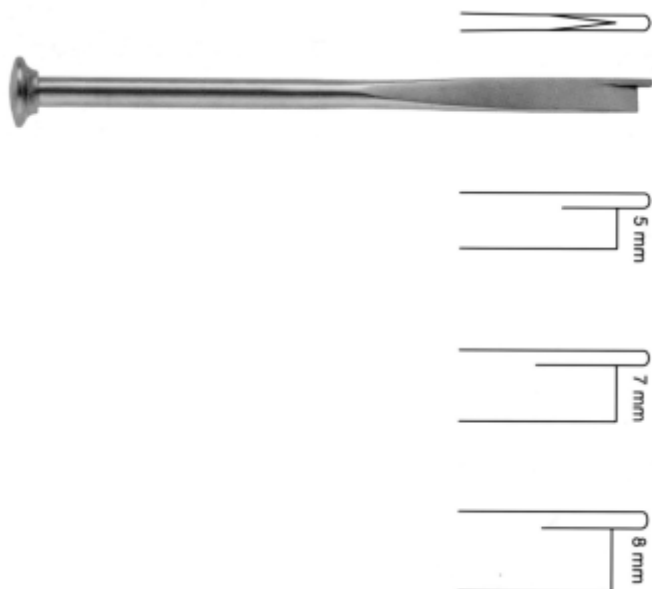

**FOMON OSTEOTOME, 17CM**

Item Code	Description
<b>05-010-001</b>	5MM, STRAIGHT
<b>05-010-002</b>	7MM, STRAIGHT
<b>05-010-003</b>	8MM, STRAIGHT



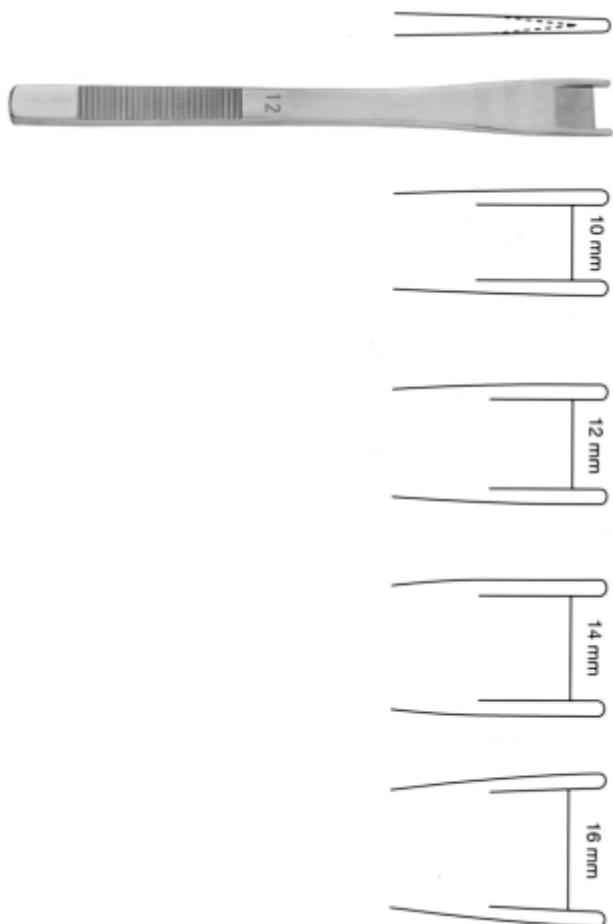

**CINELLI GUARDED OSTEOTOME, 16CM**

Item Code	Description
<b>05-011-001</b>	10MM, STRAIGHT
<b>05-011-002</b>	12MM, STRAIGHT
<b>05-011-003</b>	14MM, STRAIGHT
<b>05-011-004</b>	16MM, STRAIGHT



**OBWEGESER PERIOSTEAL ELEVATOR / RASPATORY, 20CM**

Item Code	Description
<b>05-012-001</b>	704MM, CURVED, SHARP
<b>05-012-002</b>	10X7MM, CURVED, SHARP
<b>05-012-003</b>	11X9MM, CURVED, SHARP

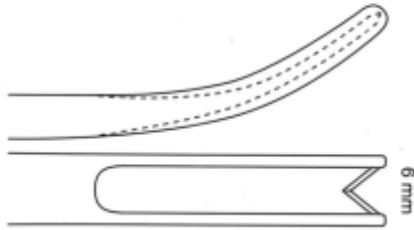

**BLUME GUARDED OSTEOTOME, 18CM**

Item Code	Description
<b>05-013-001</b>	6MM,CURVED, V SHAPED TIP

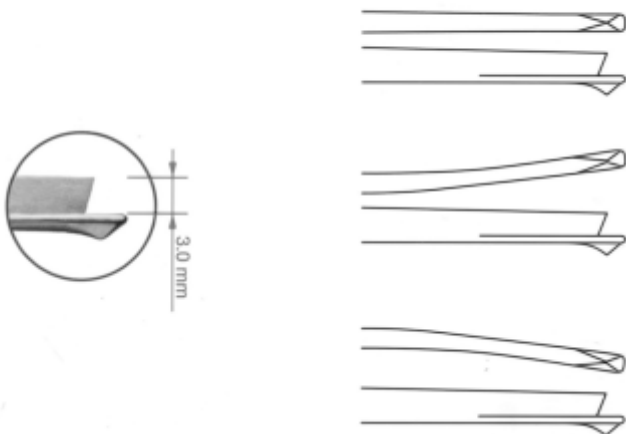

**SCHROM OSTEOTOME, 19.5CM**

Item Code	Description
<b>05-014-001</b>	3MM, STRAIGHT, WITH GUIDE THORN
<b>05-014-002</b>	3MM, RIGHT, WITH GUIDE THORN
<b>05-014-003</b>	3MM, LEFT, WITH GUIDE THORN

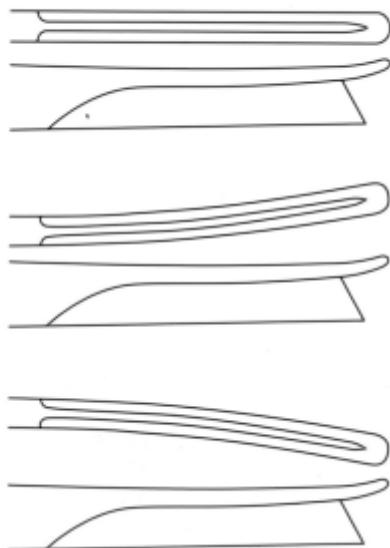

**SILVER OSTEOTOME, 18CM**

Item Code	Description
<b>05-015-001</b>	STRAIGHT
<b>05-015-002</b>	CURVED LEFT
<b>05-015-003</b>	CURVED RIGHT

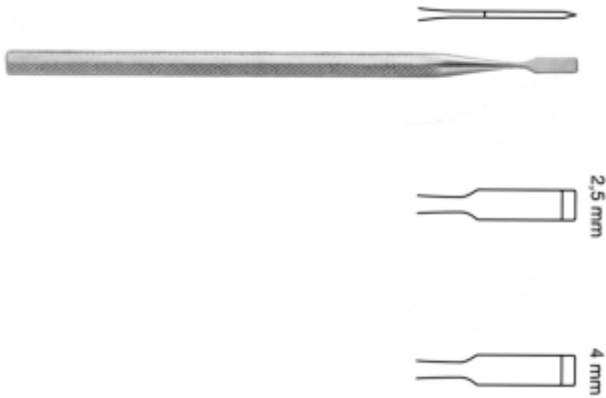

**OBWEGESER OSTEOTOME, 15CM**

Item Code	Description
<b>05-016-001</b>	2.5MM
<b>05-016-002</b>	4.0MM



**OBWEGESER SPLITTING OSTEOTOME,  
21.5CM**

Item Code	Description
<b>05-017-001</b>	7MM
<b>05-017-002</b>	10MM



**OBWEGESER WEDGE OSTEOTOME, 22CM**

Item Code	Description
<b>05-018-001</b>	8MM
<b>05-018-002</b>	12MM
<b>05-018-003</b>	16MM

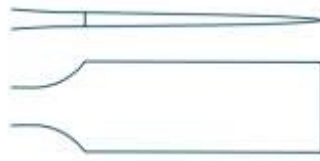

**OBWEGESER BLADE OSTEOTOME,  
22CM**

Item Code	Description
<b>05-019-001</b>	8MM
<b>05-019-002</b>	12MM
<b>05-019-003</b>	16MM
<b>05-019-004</b>	20MM



**OBWEGESER PTERYGOID OSTEOTOME**

Item Code	Description
<b>05-020-001</b>	23.5CM, 10MM, CURVED

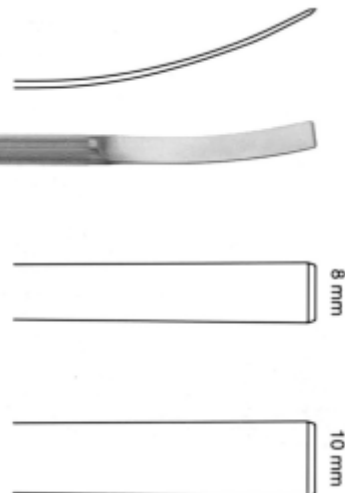

**OBWEGESER FLEXIBLE OSTEOTOME,  
21CM**

Item Code	Description
<b>05-021-001</b>	8MM, CURVED
<b>05-021-002</b>	10MM, CURVED

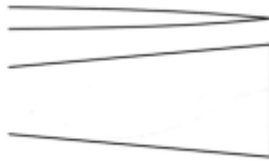

**TESSIER OSTEOTOME, 20.5CM**

Item Code Description

<b>05-022-001</b>	10MM, STRAIGHT
<b>05-022-002</b>	10MM, CURVED
<b>05-022-003</b>	15MM, STRAIGHT
<b>05-022-004</b>	15MM, CURVED
<b>05-022-005</b>	20MM, STRAIGHT
<b>05-022-006</b>	30MM, STRAIGHT

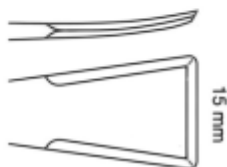
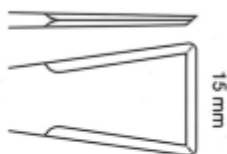

**TESSIER OSTEOTOME, 16CM,**

Item Code Description

<b>05-023-001</b>	10MM, STRAIGHT, BEVELED EDGES
<b>05-023-002</b>	10MM, CURVED, BEVELED EDGES
<b>05-023-003</b>	15MM, STRAIGHT, BEVELED EDGES
<b>05-023-004</b>	16CM, 15MM, CURVED, BEVELED EDGES

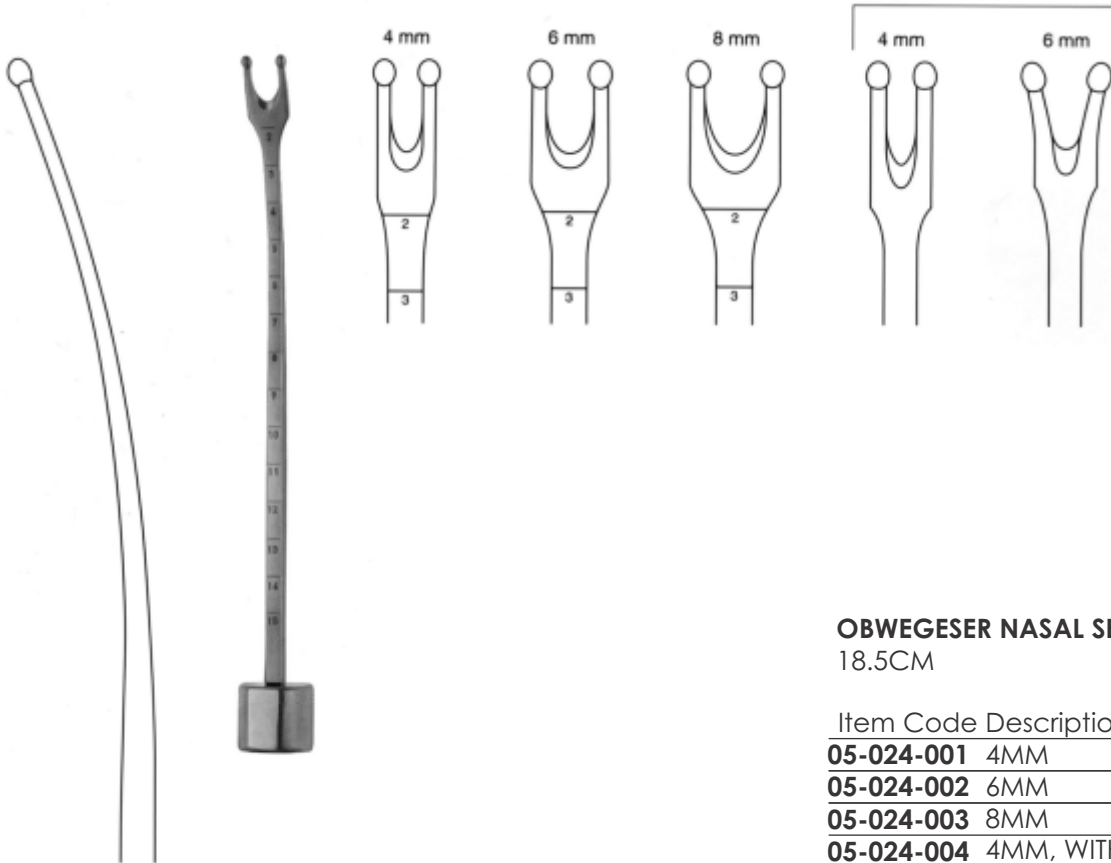

**OBWEGESER NASAL SEPTUM OSTEOTOME,**  
18.5CM

Item Code	Description
<b>05-024-001</b>	4MM
<b>05-024-002</b>	6MM
<b>05-024-003</b>	8MM
<b>05-024-004</b>	4MM, WITHOUT SCALE

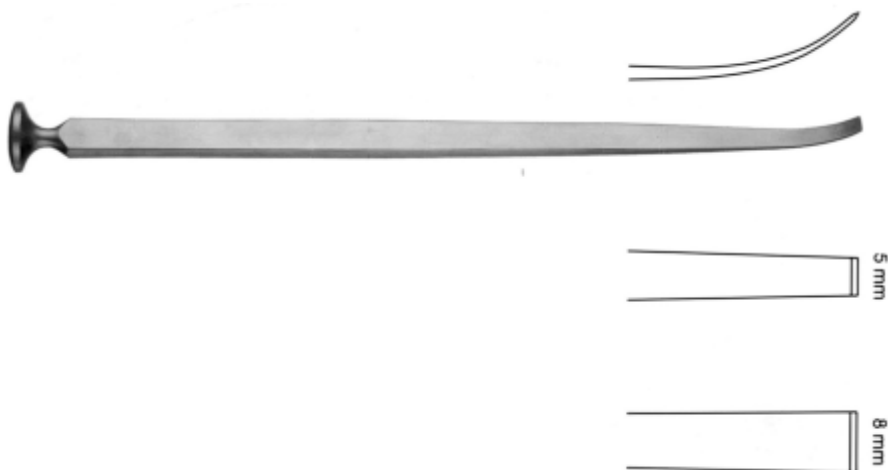

**STEINHAUSER ORBITAL OSTEOTOME,**  
22.5CM,

Item Code	Description
<b>05-025-001</b>	5MM, CURVED
<b>05-025-002</b>	8MM, CURVED



**ROZNER NASAL OSTEOTOME, 6.5 MM**

Item Code	Description
<b>05-026-001</b>	WIDTH, 6 1/2" (165 MM) LENGTH



**GIUNTA OSTEOTOME**

Item Code	Description
<b>05-027-001</b>	DOUBLE GUARDED, CURVED, 4 MM WIDTH, 7" (178 MM) LENGTH



**LAMBOTTE OSTEOTOME, 5" (127 MM)**

Item Code	Description
<b>05-028-001</b>	4 MM
<b>05-028-002</b>	6 MM
<b>05-028-003</b>	8 MM
<b>05-028-004</b>	10 MM
<b>05-028-005</b>	12 MM



**FREER RASPATORY, 19CM**

Item Code	Description
<b>05-029-001</b>	5/5MM, DOUBLE ENDED, SHARP / SHARP

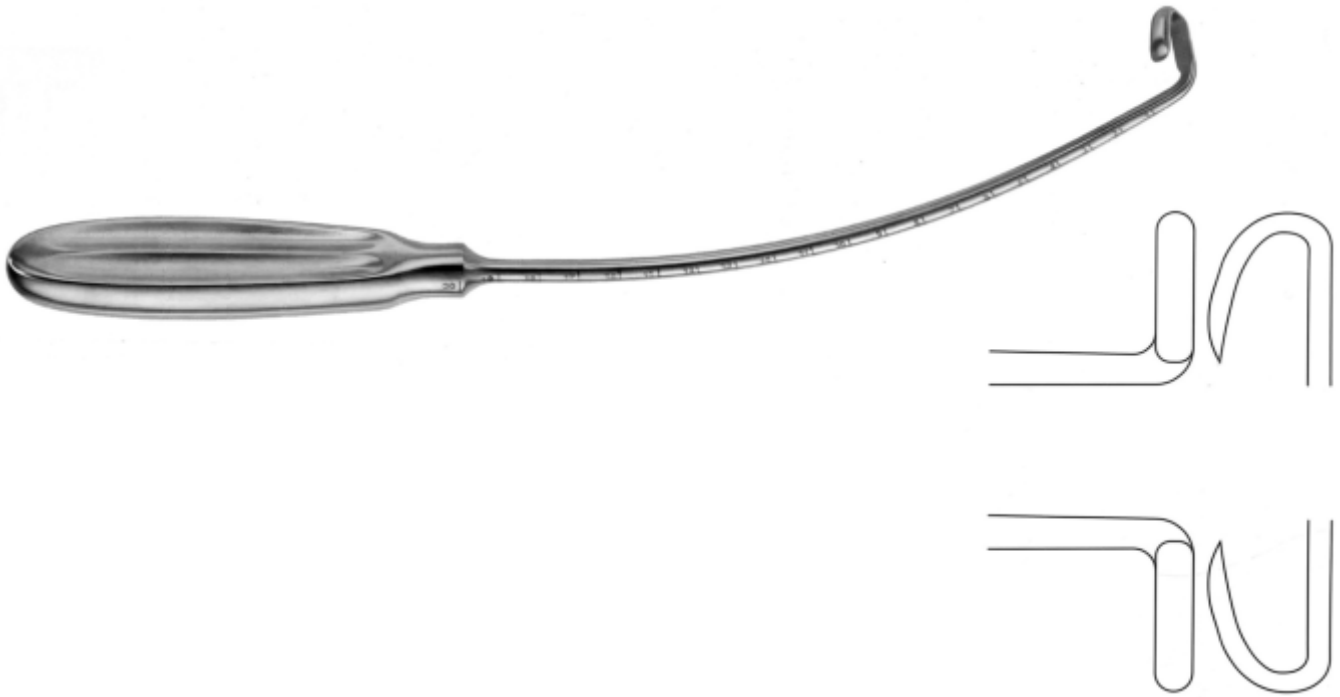

**OBWEGESER RIB RASPATORY, 30CM**

Item Code Description

**05-030-001** LEFT

**05-030-002** RIGHT

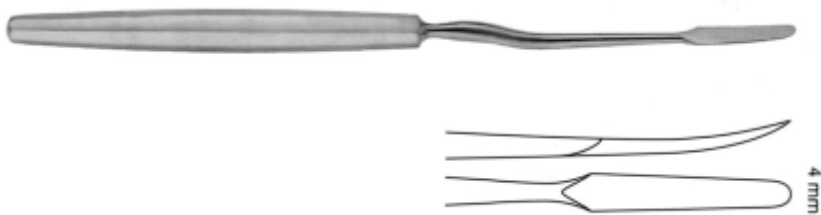

**JOSEPH MASING SEPTUM RASPATORY**

Item Code Description

**05-031-001** 22CM, 4MM, SHARP



**COTTE PERIOSTEAL ELEVATOR/RASPATORY**

Item Code Description

**05-032-001** 18CM, 8MM, SHARP



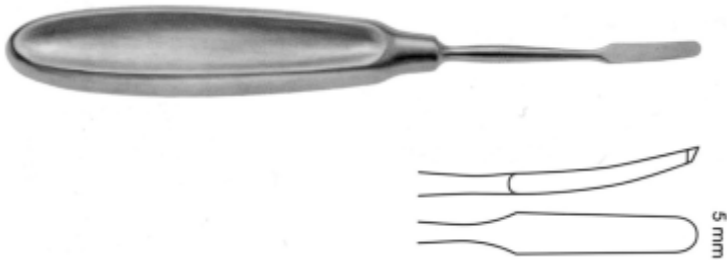

**CONVERSE PERIOSTEAL ELEVATOR/  
RASPATORY, 18CM**

Item Code Description  
**05-033-001** 5MM, SHARP



**COTTLE PERIOSTEUM COMB  
AND RASPATORY, 23CM**

Item Code Description  
**05-034-001** 1.5/5MM, DOUBLE ENDED



**COTTLE MCKENTY RASPATORY, 22CM**

Item Code Description  
**05-035-001** 4/4MM, DOUBLE ENDED, SHARP

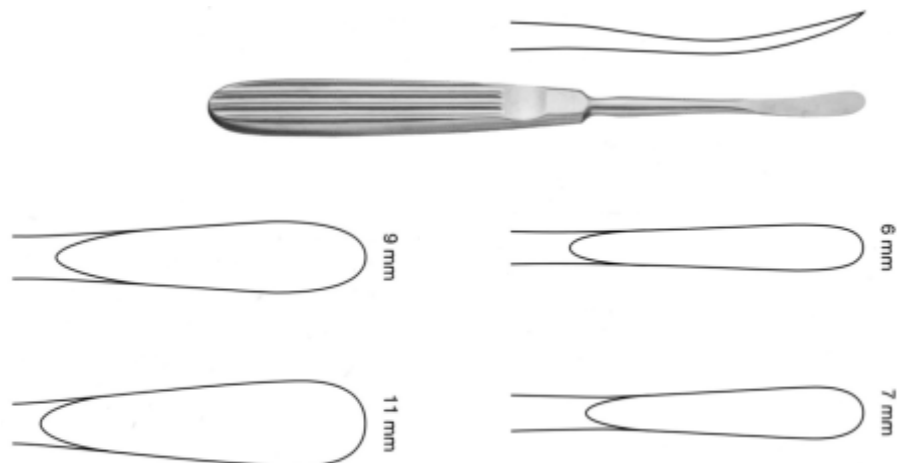

**OBWEGESER PERIOSTEAL ELEVATOR /  
ASPATORY, 17.5CM**

Item Code Description  
**05-036-001** 6MM, SHARP  
**05-036-002** 7MM, SHARP  
**05-036-003** 9MM, SHARP  
**05-036-004** 11MM, SHARP

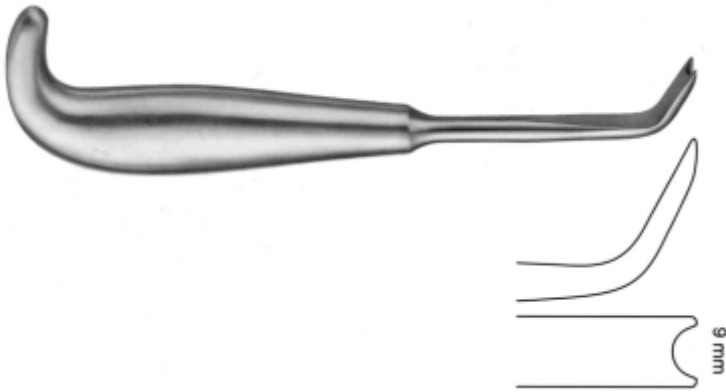

**HARGIS RASPATORY, 19CM**

Item Code	Description
<b>05-037-001</b>	9MM, ANGLED

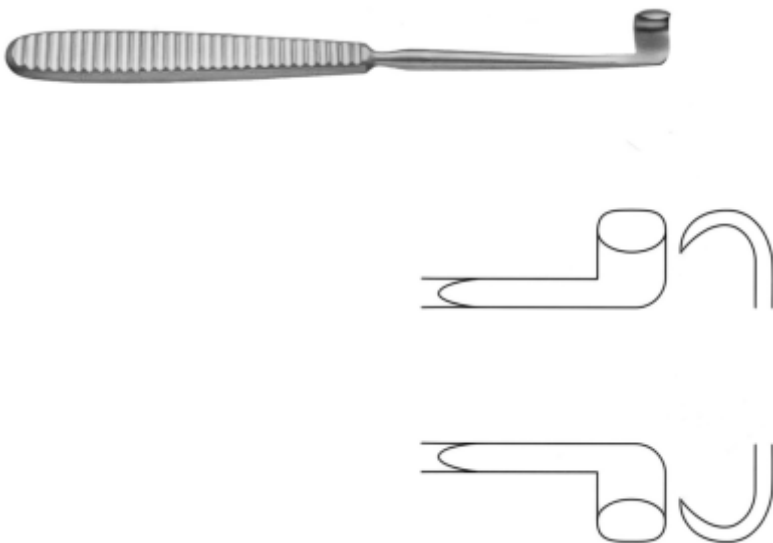

**OBWEGESER MANDIBULAR RIM STRIPPER**

Item Code	Description
<b>05-038-001</b>	19CM



**OBWEGESER PERIOSTEAL ELEVATOR / RASPATORY, 17.5CM**

Item Code	Description
<b>05-039-001</b>	9MM, V NOTCH

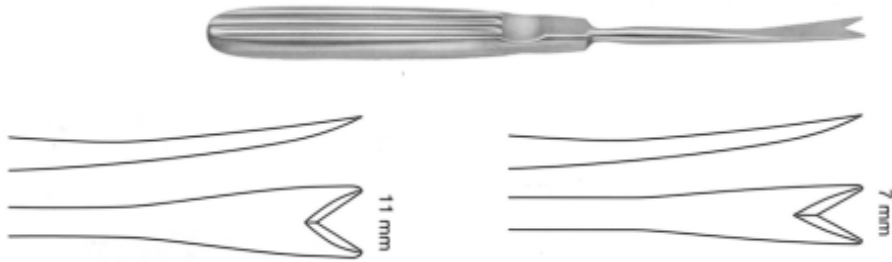

**OBWEGESER SWALLOWTAIL  
STRIPPER, 17.5CM,**

Item Code	Description
<b>05-040-001</b>	7MM
<b>05-040-002</b>	11MM

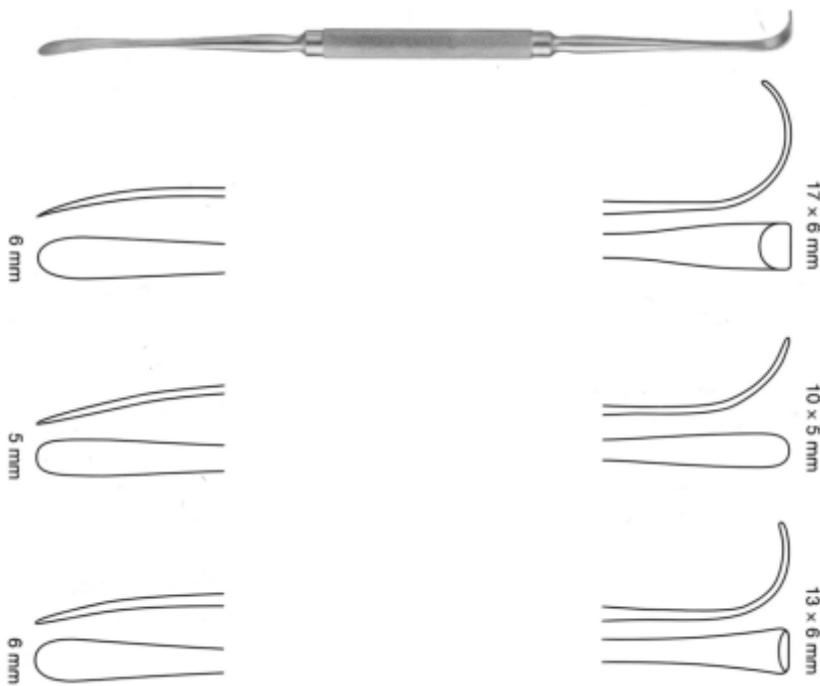

**OBWEGESER FREER PERIOSTEAL  
ELEVATOR, 21CM,**

Item Code	Description
<b>05-041-001</b>	6MM SHARP / 1705MM BLUNT
<b>05-041-002</b>	5MM SHARP / 10X5MM BLUNT
<b>05-041-003</b>	6MM SHARP / 1305MM BLUNT

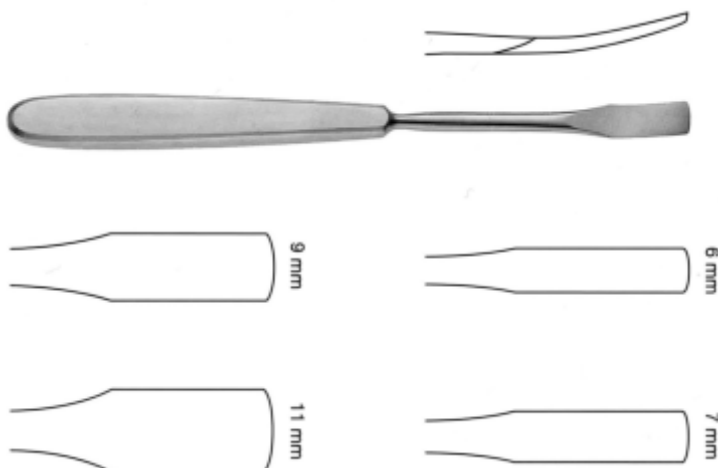

**OBWEGESER PERIOSTEAL ELEVATOR,  
18CM**

Item Code	Description
<b>05-042-001</b>	6MM, BEVELED EDGE
<b>05-042-002</b>	7MM, BEVELED EDGE
<b>05-042-003</b>	9MM, BEVELED EDGE
<b>05-042-004</b>	11MM, BEVELED EDGE

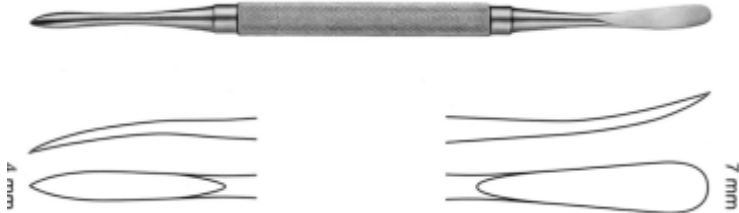

**DINGMAN PERIOSTEAL ELEVATOR /  
RASPATORY, 18CM**

Item Code	Description
<b>05-043-001</b>	4/7MM, SHARP / BLUNT



**TESSIER RASPATORY, 18CM,**

Item Code	Description
<b>05-044-001</b>	8MM, 30 DEGREE CURVED
<b>05-044-002</b>	12MM, 60 DEGREE CURVED



Item Code	Description
<b>05-045-001</b>	<b>STEINHAUSER ORBITAL FLOOR RASPATORY, 17CM, 9X4MM</b>

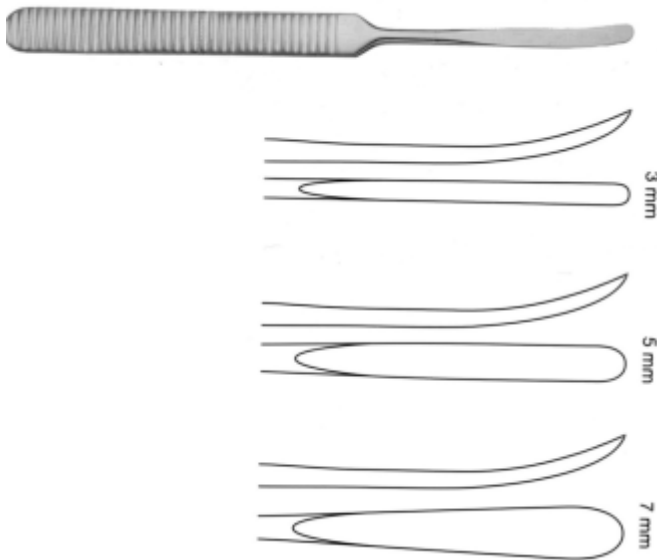

**WILLIGER RASPATORY, 16CM**

Item Code	Description
<b>06-001-001</b>	3MM, SHARP
<b>06-001-002</b>	5MM, SHARP
<b>06-001-003</b>	7MM, SHARP

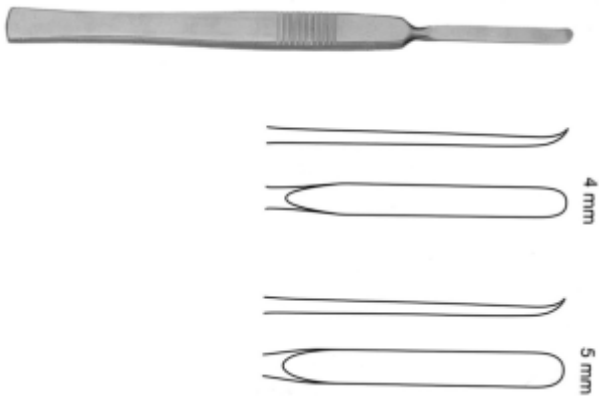

**MCKENTY RASPATORY, 15CM**

Item Code	Description
<b>06-002-001</b>	4MM, SHARP, LIGHT CURVE
<b>06-002-002</b>	5MM, SHARP, LIGHT CURVE



**FREER MUCOSA END KNIFE**

Item Code	Description
<b>06-003-001</b>	6" (15 CM)

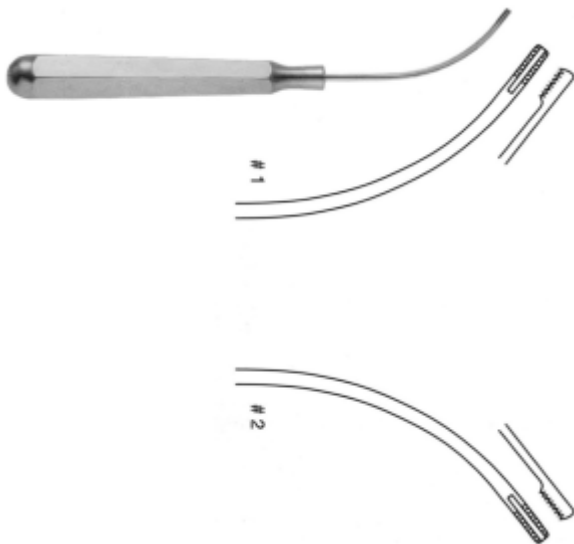

**DINGMAN CARTILAGE ABRADERS,  
SET OF TWO**

Item Code	Description
<b>07-001-001</b>	#1, 15CM, CURVED LEFT
<b>07-001-002</b>	#2, 15CM, CURVED RIGHT

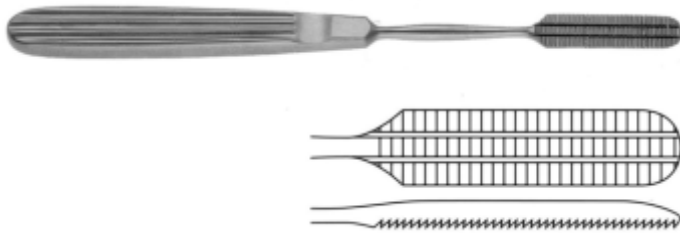

**MALTZ NASAL RASP**

Item Code	Description
<b>07-002-001</b>	18.5CM



**LEWIS NASAL RASP**

Item Code	Description
<b>07-003-001</b>	20CM

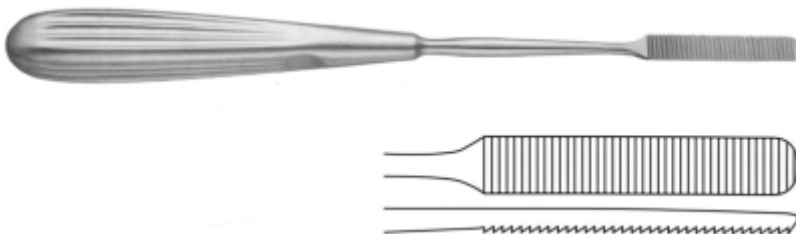

**COTTLE NASAL RASP**

Item Code	Description
<b>07-004-001</b>	21CM

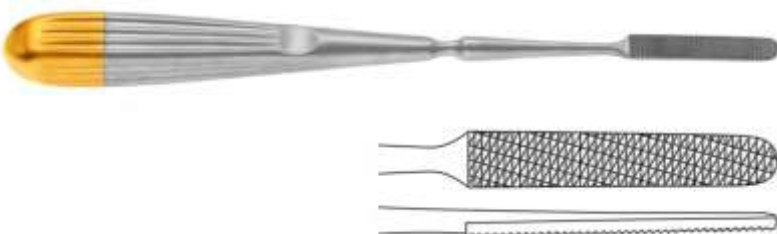

**COTTLE T.C. NASAL RASP**

Item Code	Description
<b>07-005-001</b>	20.5CM

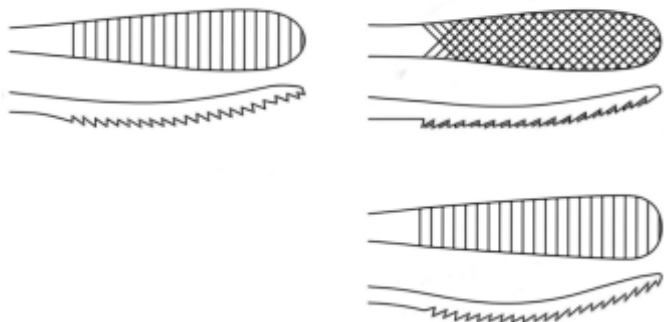

**AUFRICHT NASAL RASP, 21CM**

Item Code	Description
<b>07-006-001</b>	CROSS CUT
<b>07-006-002</b>	DOWN
<b>07-006-003</b>	UP

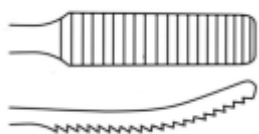

**NASAL RASP**

Item Code	Description
<b>07-007-001</b>	19.5CM, UP

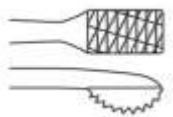

**LEWIS T.C. NASAL RASP**

Item Code	Description
<b>07-008-001</b>	19.5CM

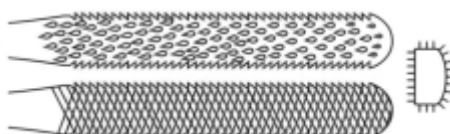
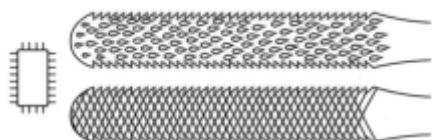

**FOMON BONE AND NASAL RASP**

Item Code	Description
<b>07-009-001</b>	20CM

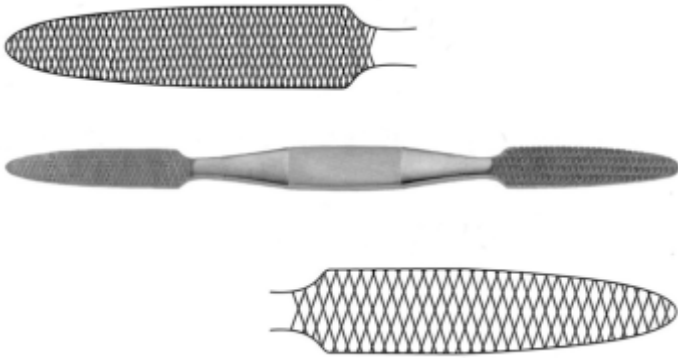

**CONVERSE BONE AND NASAL FILE**

Item Code	Description
<b>07-010-001</b>	18.5CM

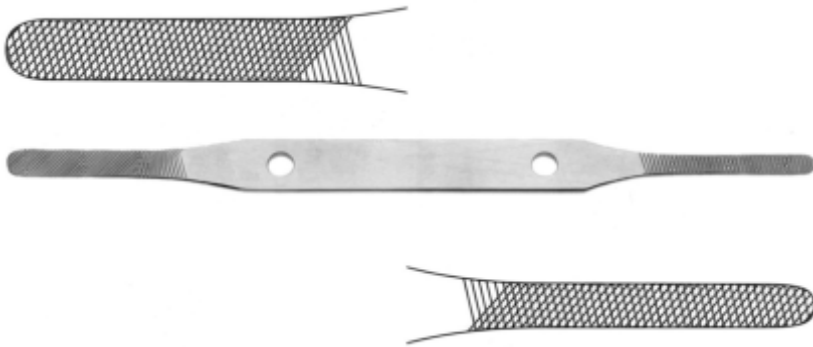

**MASING NASAL FILE**

Item Code	Description
<b>07-011-001</b>	21CM, FINE

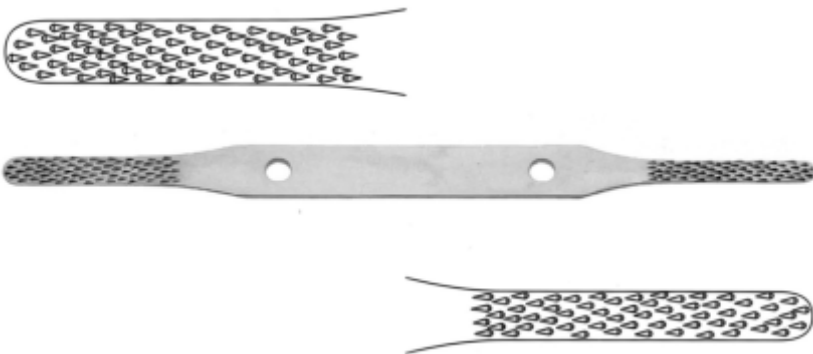

**MASING NASAL RASP**

Item Code	Description
<b>07-012-001</b>	21CM, COARSE

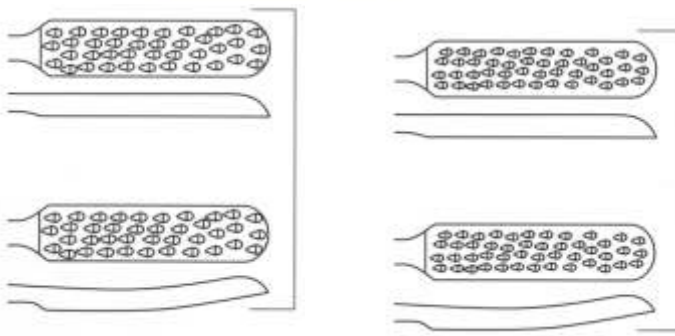

**OBWEGESER NASAL RASP, 19.5CM**

Item Code	Description
<b>07-013-001</b>	FLAT, FINE, DELICATE PATTERN
<b>07-013-002</b>	FLAT, MEDIUM FINE
<b>07-013-003</b>	CONVEX, FINE, DELICATE PATTERN
<b>07-013-004</b>	CONVEX, MEDIUM FINE



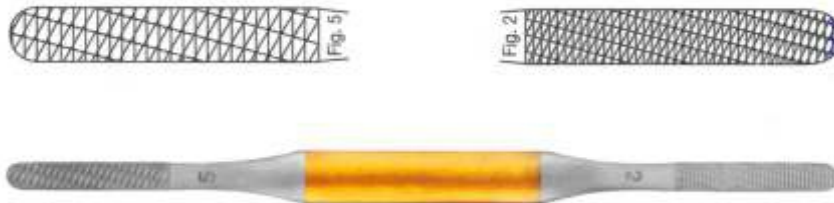

**GUBISCH FOMON T.C. NASAL RASP,  
20CM**

Item Code	Description
<b>07-014-001</b>	#1 and #2
<b>07-014-002</b>	#3 and #4
<b>07-014-003</b>	#5 and #6
<b>07-014-004</b>	#7 and #8
<b>07-014-005</b>	#9 and #10

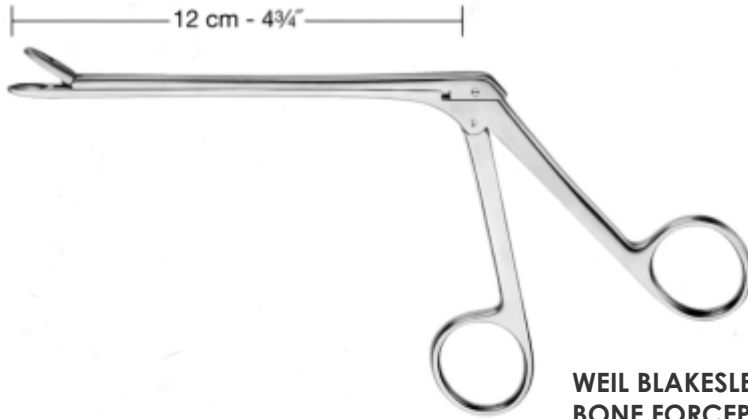

**WEIL BLAKESLEY WILDE ETHMOID BONE FORCEP**

NORMAL SHAFT

		<b>45°</b>	<b>90°</b>
3,0 mm	08-001-001.	08-001-006	08-001-010
3,6 mm	08-001-002	08-001-007	08-001-011
4,2 mm	08-001-003	08-001-008	08-001-012
4,8 mm	08-001-004	08-001-009	08-001-013
5,6 mm	08-001-005		

SLIM SHAFT

		<b>45°</b>
3,0 mm	08-002-001	08-002-006
3,6 mm	08-002-002	08-002-007
4,2 mm	08-002-003	08-002-008
4,8 mm	08-002-004	08-002-009
5,6 mm	08-002-005	

11,5 cm - 4½"



**WEIL BLAKESLEY FORCEPS,  
THROUGH CUT**



45°

2,0 mm 

08-003-001

08-003-004

2,5 mm 

08-003-002

08-003-005

3,0 mm 

08-003-003

08-003-006



**COTTLE DOUBLE HOOK, 15CM**

Item Code	Description
<b>09-001-001</b>	SHARP, 3X4MM

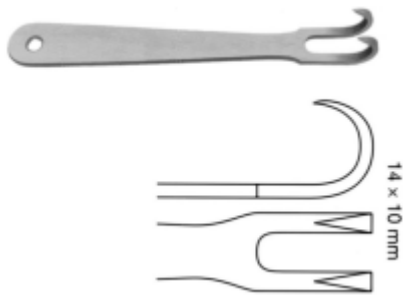

**KILNER DOUBLE NASAL HOOK, 10CM**

Item Code	Description
<b>09-002-001</b>	SHARP, 1409MM

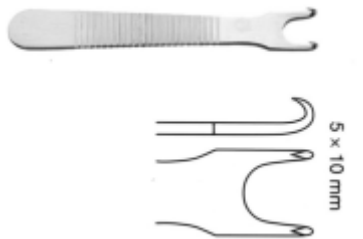

**GUBISCH KILNER DOUBLE NASAL HOOK (ALAR RETRACTOR)**

Item Code	Description
<b>09-003-001</b>	8CM, SHARP, 5090 MM

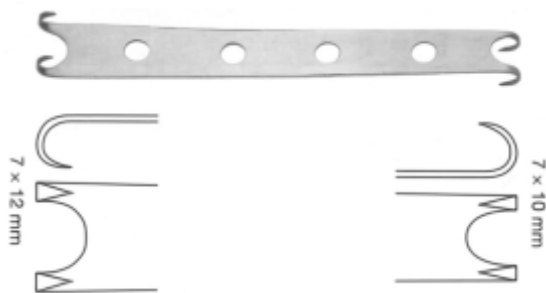

**CONVERSE ALAR RETRACTOR, 12CM**

Item Code	Description
<b>09-004-001</b>	DOUBLE ENDED, 709MM AND 7X14MM

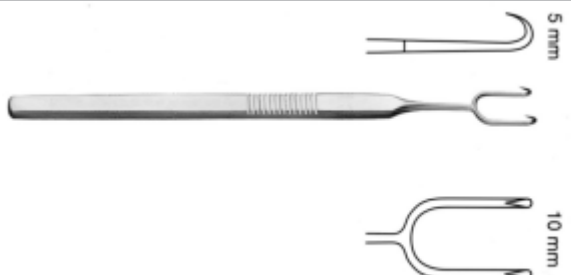

**COTTLE ALAR AND SKIN HOOK, 14CM**

Item Code	Description
<b>09-005-001</b>	2 PRONGS, SHARP, 509MM



**MILLARD COTTLE RETRACTOR**

Item Code	Description
<b>09-006-001</b>	WITH FINGER RING, 5.5CM, DOUBLE PRONG, SHARP, 5X12MM

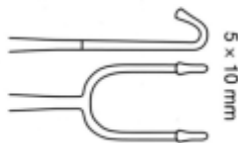

**FOMON RETRACTOR, 17CM**

Item Code	Description
<b>09-007-001</b>	BALL TIPS, 5 X 10 MM

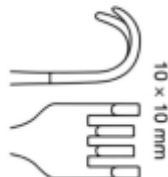

**COTTLE RETRACTOR, 15CM**

Item Code	Description
<b>09-008-001</b>	4 PRONGS, BLUNT, 10090 MM

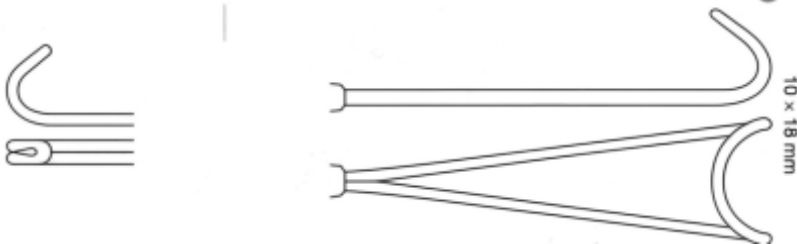

**MASING RETRACTOR, 20CM**

Item Code	Description
<b>09-009-001</b>	WITH GUIDE CHANNEL, 10X18MM



**NEIVERT RETRACTOR, 19CM**

Item Code	Description
<b>09-010-001</b>	DOUBLE ENDED, WITH GUIDE CHANNEL, 509MM



**COTTLE NEIVERT RETRACTOR, 21CM**

Item Code	Description
<b>09-011-001</b>	DOUBLE ENDED, 5090MM



**COTTLE ALAR RETRACTOR, 14CM,**

Item Code	Description
<b>09-012-001</b>	13X12MM

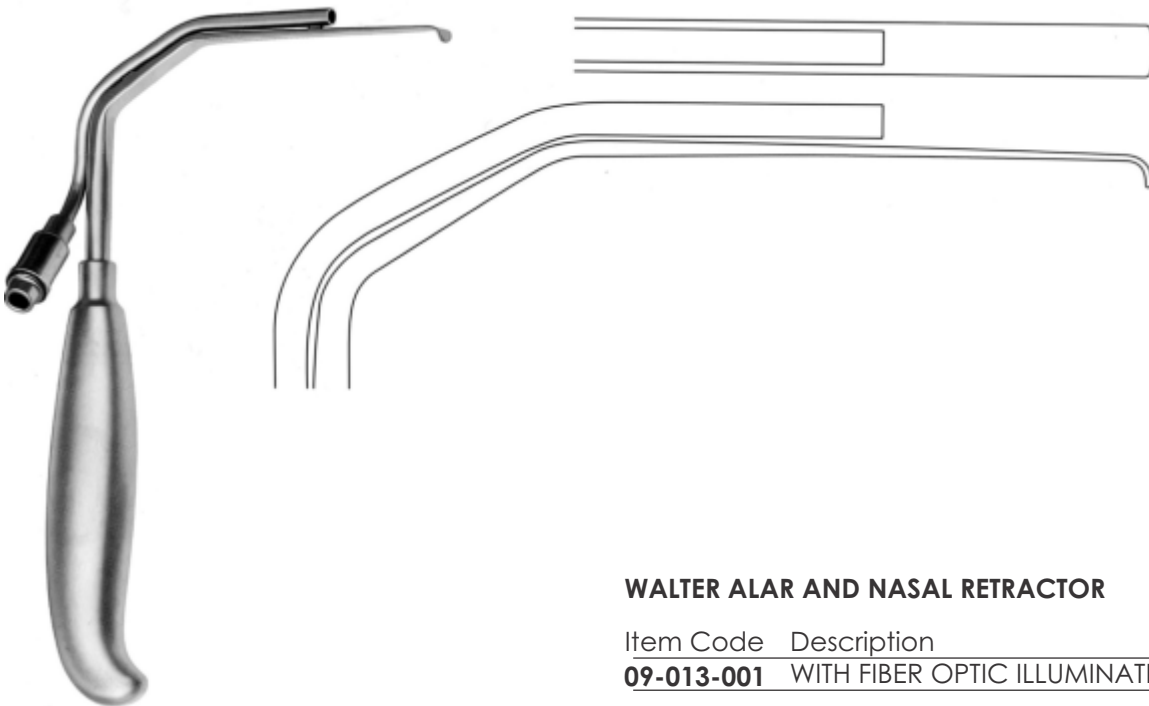

**WALTER ALAR AND NASAL RETRACTOR**

Item Code	Description
<b>09-013-001</b>	WITH FIBER OPTIC ILLUMINATION, 18.5CM

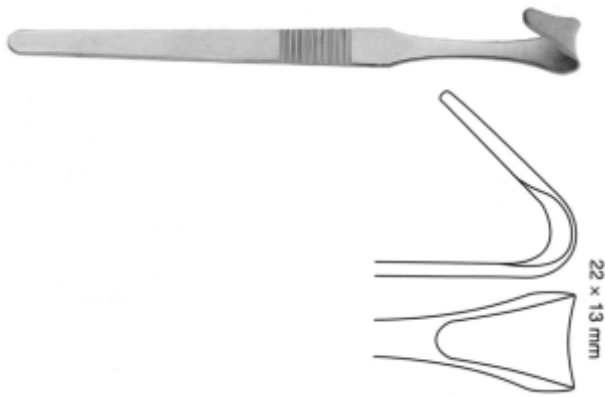

**COTLE ALAR RETRACTOR, 15CM**

Item Code	Description
<b>09-014-001</b>	22X13MM

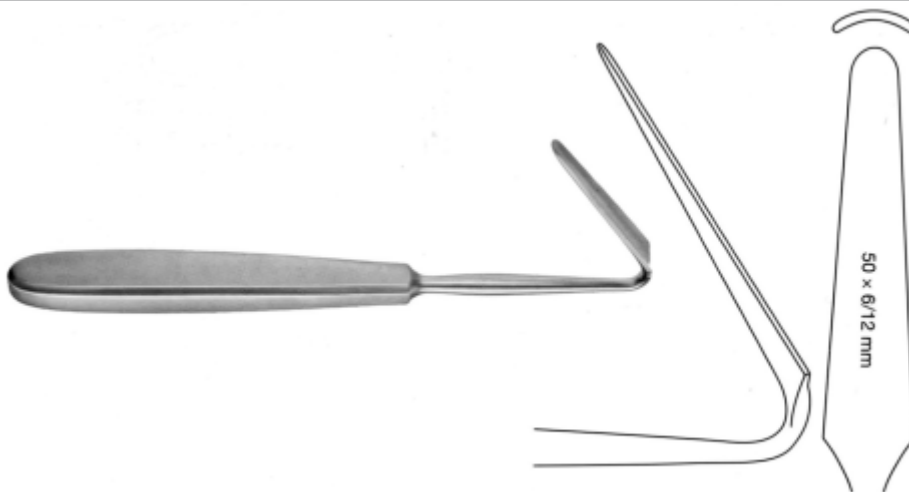

**GUBISCH AUFRICHT NASAL RETRACTOR,  
17CM**

Item Code	Description
<b>09-015-001</b>	50X6-12MM

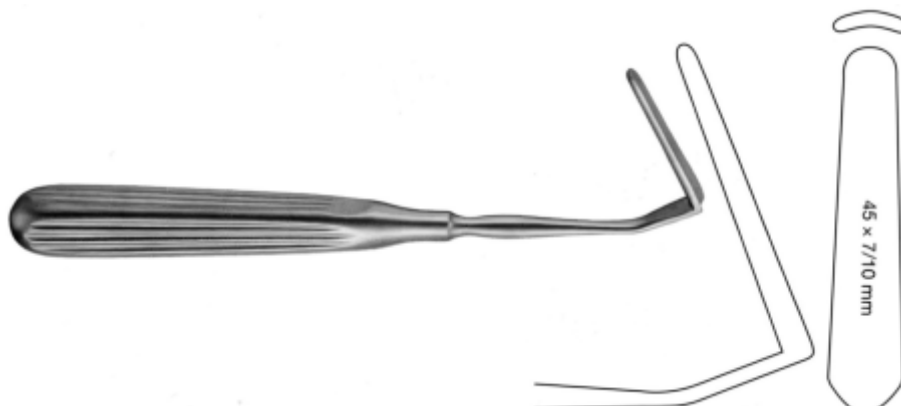

**AUFRICHT NASAL RETRACTOR,  
18CM**

Item Code	Description
<b>09-016-001</b>	45X7-10MM

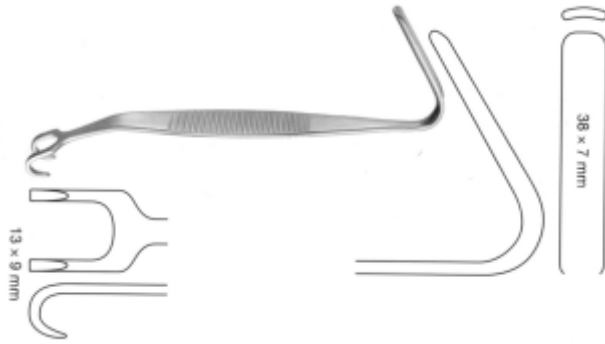

**AUFRICHT NASAL RETRACTOR, 13.5CM**

Item Code	Description
<b>09-017-001</b>	DOUBLE ENDED, BLUNT, 38X7MM

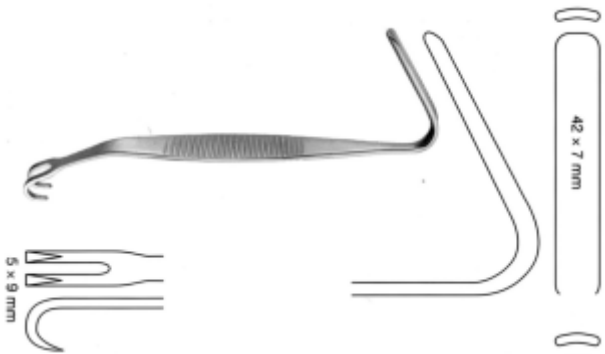

**AUFRICHT WALTER NASAL RETRACTOR**

Item Code	Description
<b>09-018-001</b>	13.5CM, DOUBLE ENDED, BLUNT, 38X7MM

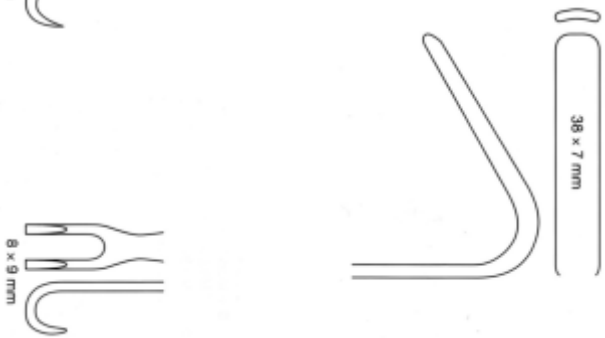

Item Code	Description
<b>09-018-002</b>	13.5CM, DOUBLE ENDED, SHARP, 42X7MM

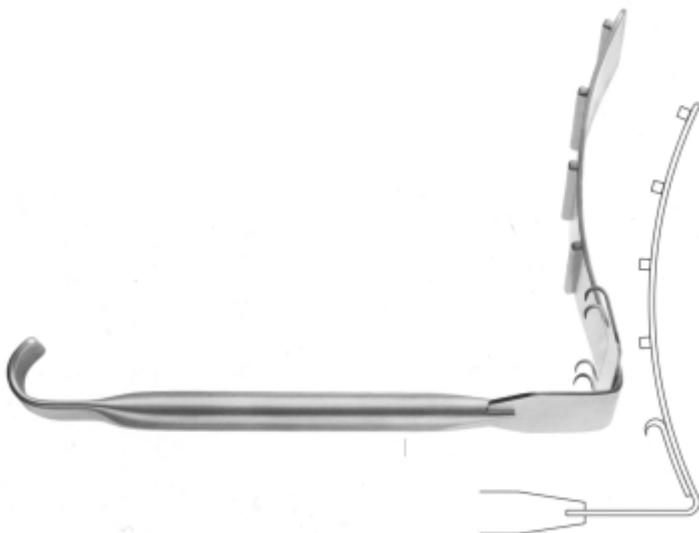

**SALDANHA RETRACTOR**

Item Code	Description
<b>09-019-001</b>	9 1/4" (23.5cm)





**AUFRICHT NASAL RETRACTOR**

Item Code	Description
<b>09-020-001</b>	6 1/4" (16CM), 7MM TIP, 45MM BLADE, WITH FIBER OPTIC LIGHT GUIDE
<b>09-020-002</b>	7" (18CM), 10MM TIP, 45MM BLADE, WITH FIBER OPTIC LIGHT GUIDE



**CONVERSE BLADE NASAL RETRACTOR,  
WITH FIBER OPTIC LIGHT GUIDE**

Item Code	Description
<b>09-021-001</b>	20MM X 10MM WIDE
<b>09-021-002</b>	30MM X 12MM WIDE
<b>09-021-003</b>	40MM X 12MM WIDE
<b>09-021-004</b>	50MM X 12MM WIDE,



**FOMON NASAL RETRACTOR**

Item Code	Description
<b>09-022-001</b>	1 BALL END PRONG, 6 1/4" (16 CM)
<b>09-022-002</b>	2 BALL END PRONGS, 6 1/4" (16 CM)



**JOSEPH NASAL SAW**

Item Code	Description
<b>10-001-001</b>	17CM, STRAIGHT



**JOSEPH NASAL SAW, 17CM**

Item Code	Description
<b>10-002-001</b>	LEFT
<b>10-002-002</b>	RIGHT

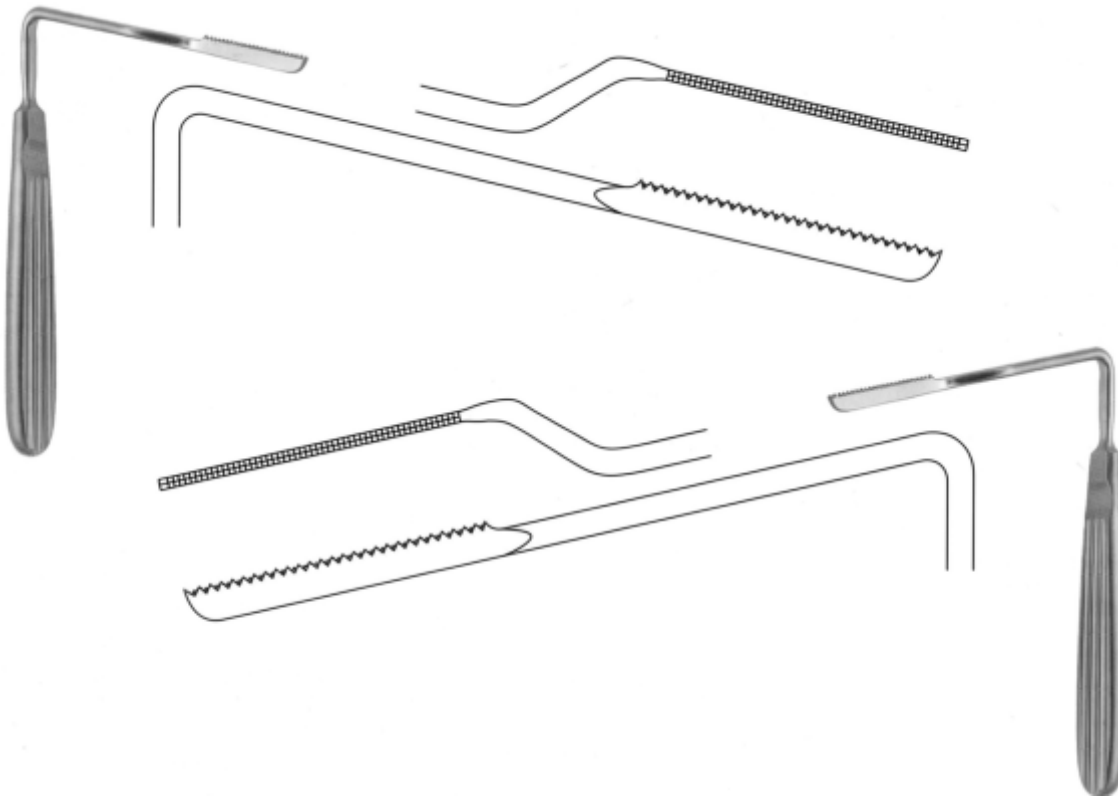

**JOSEPH NASAL SAW**

Item Code	Description
<b>10-003-001</b>	ANGLED TO LEFT
<b>10-003-002</b>	ANGLED TO RIGHT



**LUC BRUENINGS HEYMANN ETHMOID  
FORCEPS**

Item Code	Description
<b>11-001-001</b>	18CM

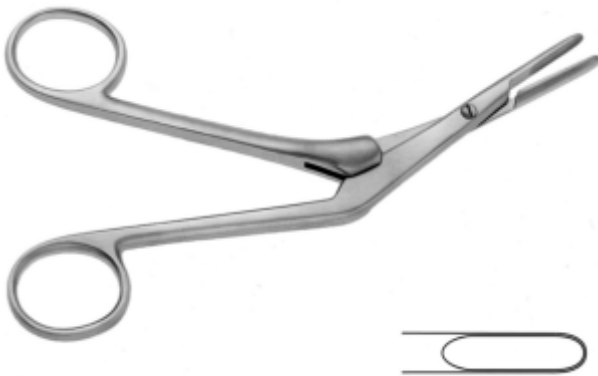

**CRAIG VOMER FORCEPS**

Item Code	Description
<b>11-002-001</b>	17CM



**CRAIG DOMNICK SEPTUM FORCEPS,  
17CM**

Item Code	Description
<b>11-003-001</b>	CURVED RIGHT
<b>11-003-002</b>	CURVED LEFT



**OBWEGESER NASAL SEPTUM CUTTER /  
PERFORATION FORCEPS**

Item Code	Description
<b>11-004-001</b>	18.5CM



**TIECK HALLE NASAL SPECULUM,  
13.5CM**

Item Code	Description
<b>12-001-001</b>	FOR BABIES
<b>12-001-002</b>	FOR INFANTS

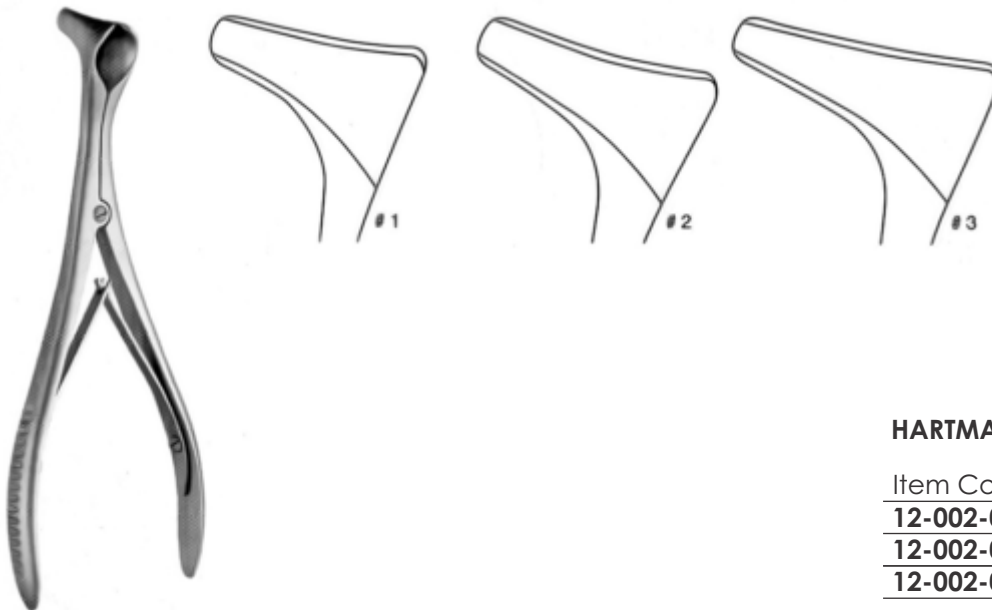

**HARTMANN NASAL SPECULUM**

Item Code	Description
<b>12-002-001</b>	#1, 15CM
<b>12-002-002</b>	#2, 15CM
<b>12-002-003</b>	#3, 15CM

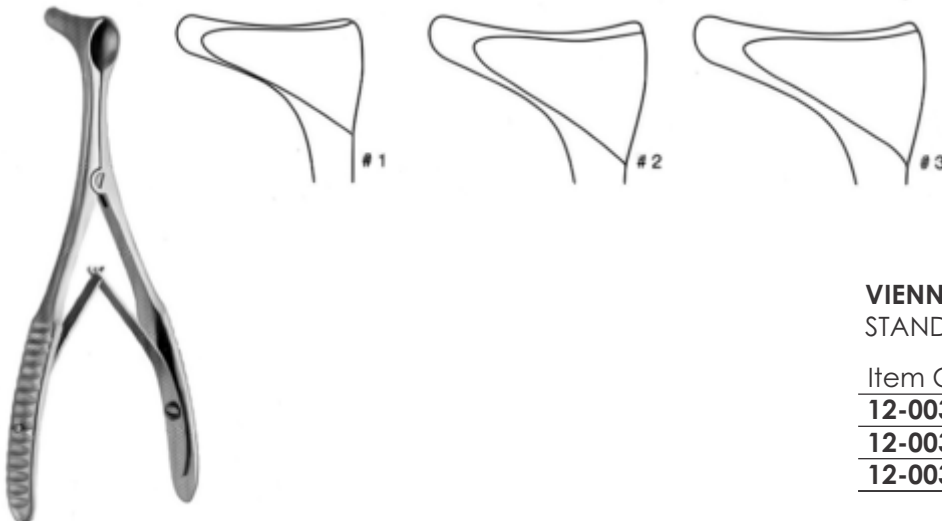

**VIENNA MODEL (MODIFIED WIEN)  
STANDARD NASAL SPECULUM**

Item Code	Description
<b>12-003-001</b>	#1, 14CM
<b>12-003-002</b>	#2, 14CM
<b>12-003-003</b>	#3, 14CM



**KILLIAN NASAL SPECULUM**

Item Code	Description
<b>12-004-001</b>	#1, 14CM, 35MM
<b>12-004-002</b>	#2, 14CM, 50MM
<b>12-004-003</b>	#3, 14CM, 75MM
<b>12-004-004</b>	#4, 14CM, 90MM

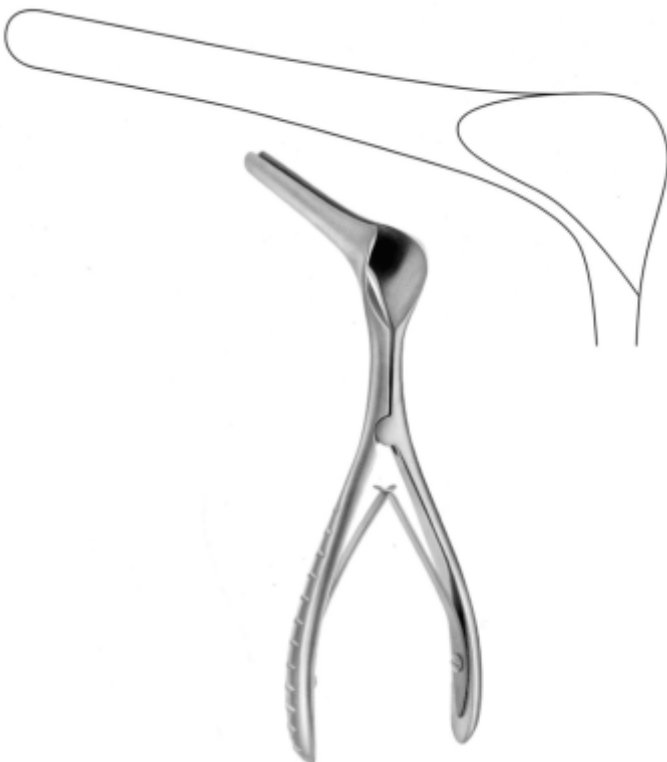

**KILLIAN ASEPT NASAL SPECULUM**

Item Code	Description
<b>12-005-001</b>	#4, 90MM (MODIFIED)



**COTTLE NASAL SPECULUM**

Item Code	Description
<b>12-006-001</b>	#1, 14CM, 35MM
<b>12-006-002</b>	#2, 14CM, 55MM
<b>12-006-003</b>	#3, 14CM, 75MM
<b>12-006-004</b>	#4, 14CM, 90MM



**COTTLE NASAL SEPTUM SPECULUM**

Item Code	Description
<b>12-006-001</b>	14CM, 50MM



**COTTLE NASAL SPECULUM**

Item Code	Description
<b>12-007-001</b>	DELICATE, 15CM, 55MM



**COTTLE NASAL KNIFE**

Item Code	Description
<b>13-001-001</b>	14CM, STRAIGHT



**JOSEPH NASAL KNIFE**

Item Code	Description
<b>13-002-001</b>	15CM, STRAIGHT, BUTTON END



**CONVERSE RHINOPLASTY KNIFE**

Item Code	Description
<b>13-003-001</b>	15CM, CURVED, BUTTON END



**COTTLE DOUBLE EDGED KNIFE**

Item Code	Description
<b>13-004-001</b>	15CM, STRAIGHT



**JOSEPH DOUBLE EDGED KNIFE**

Item Code	Description
<b>13-005-001</b>	15CM, CURVED, SHARP TIP



**JOSEPH BUTTON END KNIFE**

Item Code	Description
<b>13-006-001</b>	16CM, ANGLED

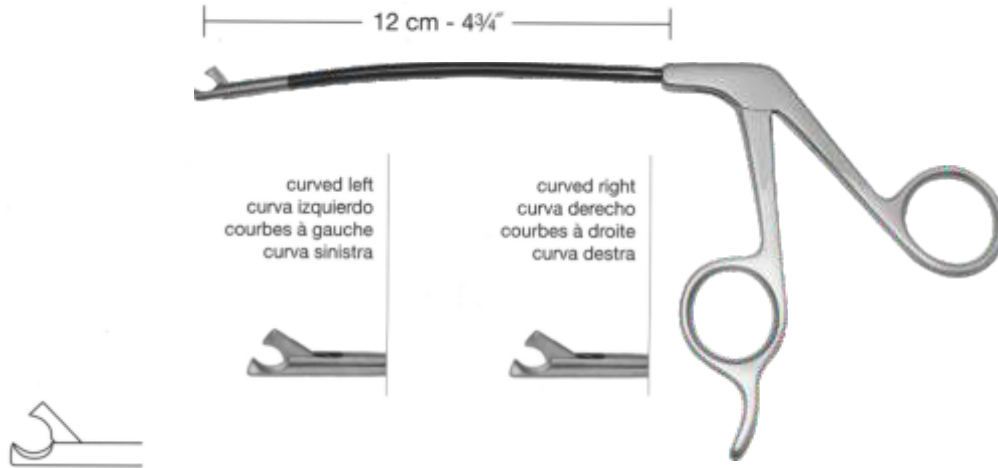

**HOOK SCISSORS, 12cm SHAFT**

Item Code	Description
<b>14-001-001</b>	LEFT
<b>14-001-002</b>	RIGHT

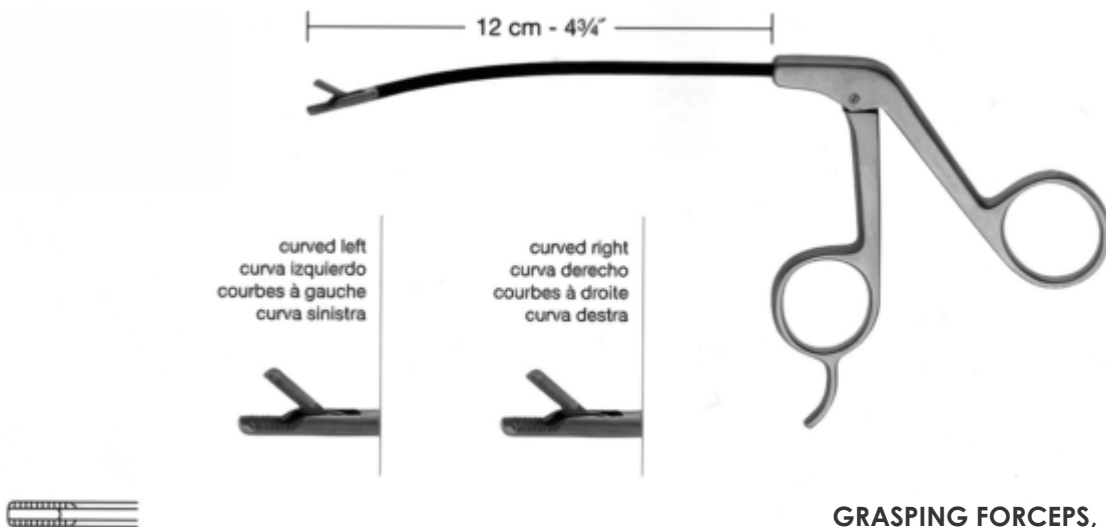

**GRASPING FORCEPS, 12cm SHAFT**

Item Code	Description
<b>14-002-001</b>	LEFT
<b>14-002-002</b>	RIGHT



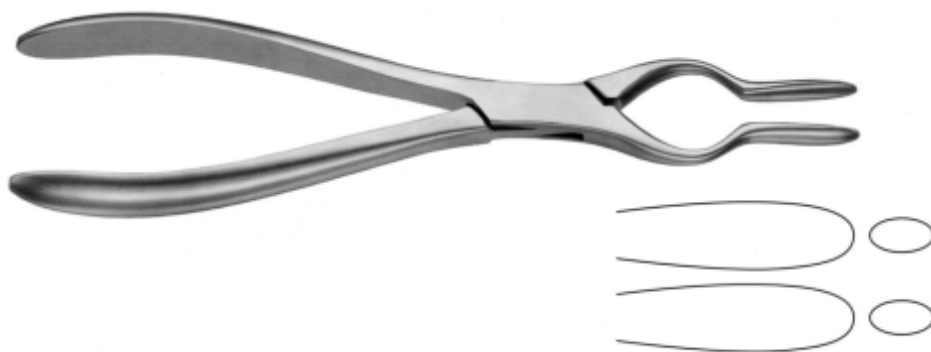

**WALSHAM UNIVERSAL  
SEPTUM FORCEPS**

Item Code	Description
<b>15-001-001</b>	23CM

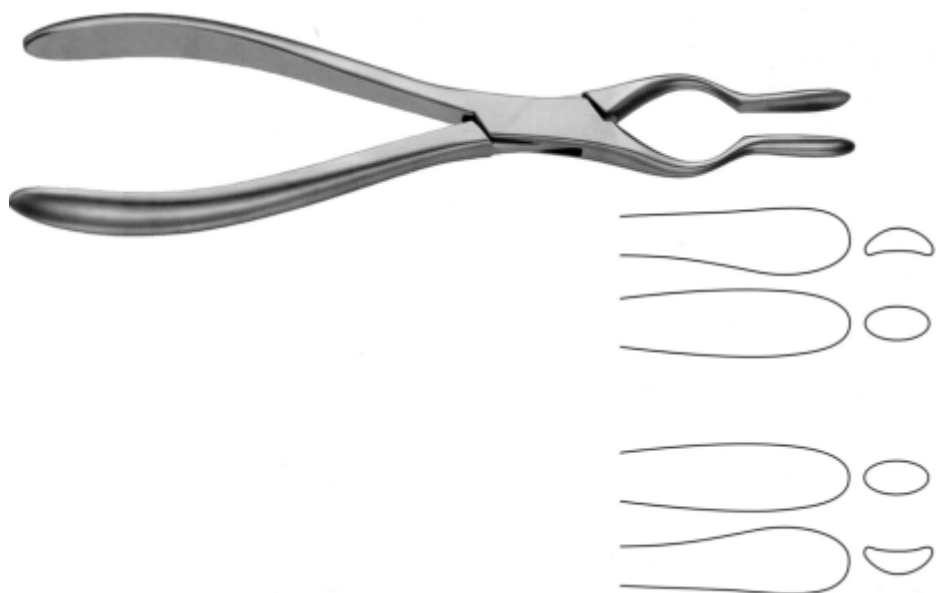

**WALSHAM SEPTUM STRAIGHTENING  
FORCEPS, 23CM**

Item Code	Description
<b>15-002-001</b>	RIGHT
<b>15-002-002</b>	LEFT

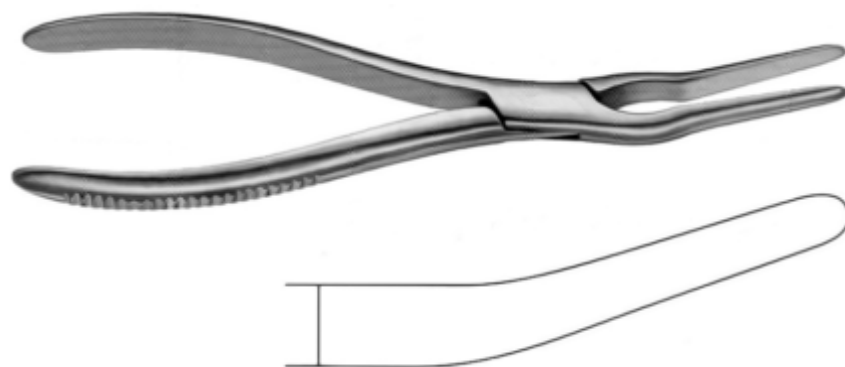

**ASCH SEPTUM STRAIGHTENING  
FORCEPS**

Item Code	Description
<b>15-003-001</b>	22CM, ANGLED

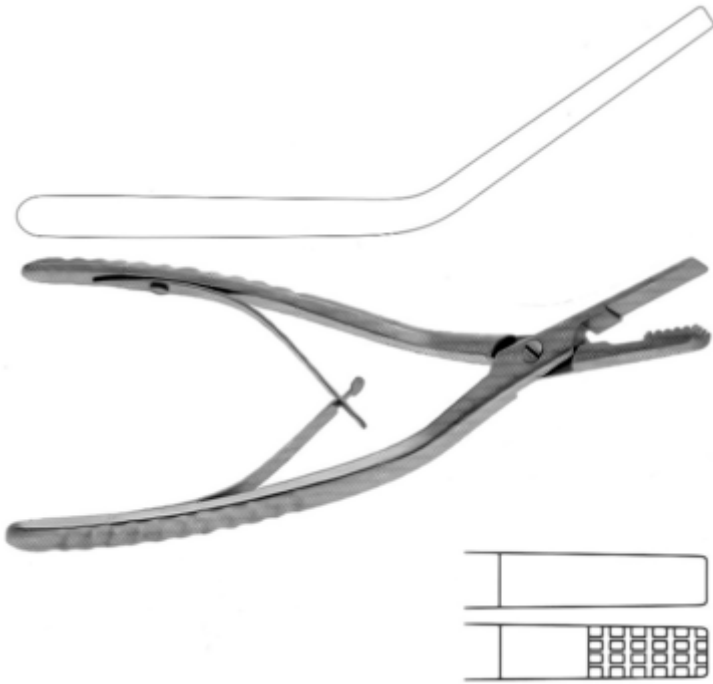

**OBWEGESER NASAL SEPTUM CUTTER /  
PERFORATION FORCEPS**

Item Code	Description
<b>15-004-001</b>	18.5CM



**MOLT MOUTH GAG**

Item Code	Description
<b>16-001-001</b>	10CM, CHILD SIZE
<b>16-001-002</b>	5CM, ADULT SIZE



**ROSER KOENIG MOUTH GAG**

Item Code	Description
<b>16-002-001</b>	16CM



**DENHART MOUTH GAG**

Item Code	Description
<b>16-003-001</b>	13CM

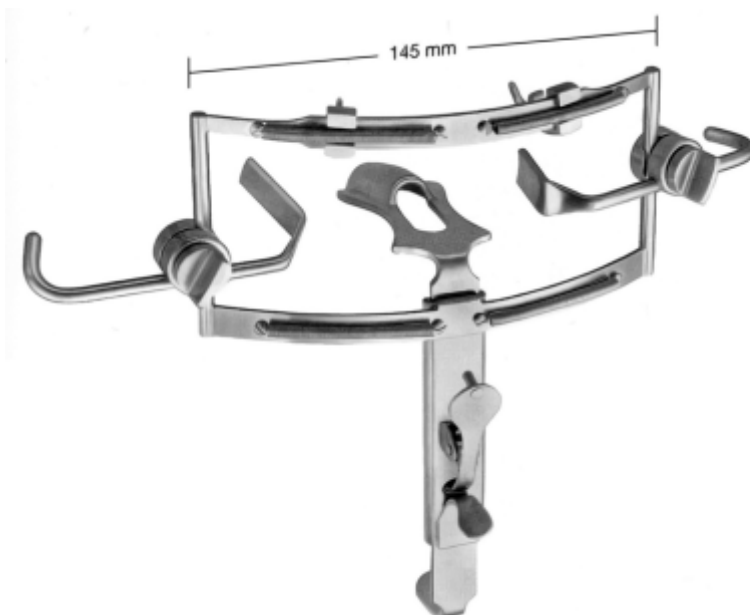

**DINGMAN MOUTH GAG**

Item Code	Description
<b>16-004-001</b>	COMPLETE

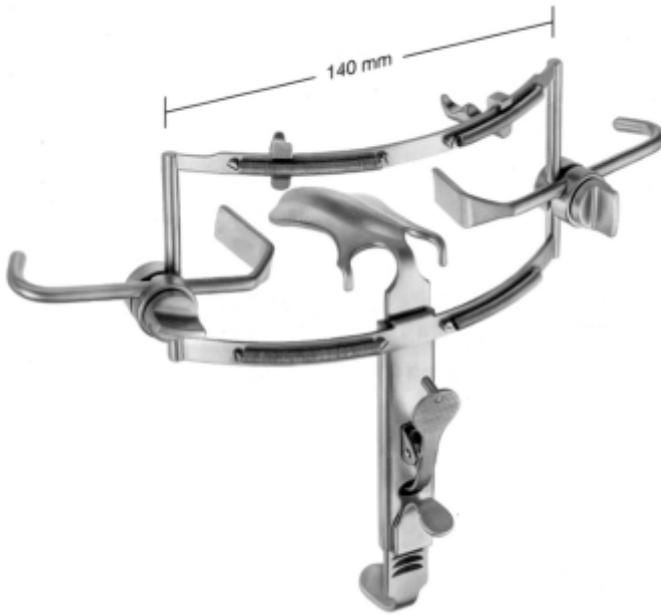

55 x 32 mm  
Fig.1

Tongue depressor  
Bajalengua  
Abaisse-langue  
Abbassalingua

60 x 35 mm  
Fig.2

75 x 38 mm  
Fig.3

**WANG MOUTH GAG**

Item Code	Description
<b>16-005-001</b>	<b>COMPLETE</b>



**YANCOSKIE CORONAL LIFT RETRACTOR**

Item Code	Description
<b>17-001-001</b>	OFFSET 8½" (216mm) WIDTH 150mm



**YANCOSKIE ABDOMINOPLASTY RET.**

Item Code	Description
<b>17-002-001</b>	OFFSET 7½" (190mm) WIDTH 150mm

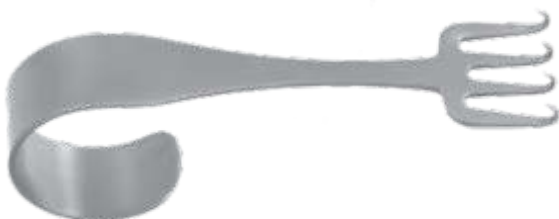

**FREEMAN FACE LIFT RETRACTOR**

Item Code	Description
<b>17-003-001</b>	SMALL FINGER RING, 4" (102mm) WIDTH 21.8mm
<b>17-003-002</b>	LARGE FINGER RING, 4¾" (121mm) WIDTH 25mm



**FREEMAN FACE LIFT RETRACTOR**

Item Code	Description
<b>17-004-001</b>	ADAMSON MODEL, 7" (178mm), 37mm



Item Code	Description
<b>17-005-001</b>	<b>FREEMAN FLAP RAKE RETRACTOR</b> 4 1/4" (108mm), 1 1/4" (32mm)



**FREEMAN RAKE RETRACTOR**

Item Code	Description
<b>17-006-001</b>	4" (100mm), WIDTH (22mm)
<b>17-006-002</b>	4" (100mm), WIDTH (38mm)



**GORNEY RAKE RETRACTOR**

Item Code	Description
<b>17-007-001</b>	3" (75mm), WIDTH (38mm)
<b>17-007-002</b>	4 1/4" (108mm), WIDTH (38mm)



**FRAZIER HOOK**

Item Code	Description
<b>17-008-001</b>	SHARP, 5" (127mm), 5mm
<b>17-008-002</b>	BLUNT, 5" (127mm), 5mm



**TYRELL HOOK**

Item Code	Description
<b>17-009-001</b>	SHARP, 5" (127mm), 2mm
<b>17-009-002</b>	BLUNT, 5" (127mm), 2mm



**KILNER SKIN HOOK**

Item Code	Description
<b>17-010-001</b>	SHARP, SMOOTH HANDLE, 5" (127mm), 2.5mm



**GUTHRIE HOOK**

Item Code	Description
<b>17-011-001</b>	SHARP, 4¾" (121mm), 2.5mm



**JOSEPH DOUBLE PRONG HOOK**

Item Code	Description
<b>17-012-001</b>	SHARP, 6¼" (159mm), 2mm
<b>17-012-002</b>	SHARP, 6¼" (159mm), 5mm
<b>17-012-003</b>	SHARP, 6¼" (159mm), 7mm
<b>17-012-004</b>	SHARP, 6¼" (159mm), 10mm
<b>17-012-005</b>	SHARP, 6¼" (159mm), 12mm



**MAMMAPLASTY OR MASTECTOMY HOOK**

Item Code	Description
<b>17-013-001</b>	EXTRA LARGE, SHARP, 7½" (191mm), 10mm



**FREEMAN SKIN HOOK, 4" (102mm)**

Item Code	Description
<b>17-014-001</b>	SINGLE SHARP HOOK, 5mm
<b>17-014-002</b>	DOUBLE SHARP HOOK, 5mm



**CLODIUS FISH HOOK RETRACTOR**

Item Code	Description
<b>17-015-001</b>	WITH CHAIN, SMALL, 7mm
<b>17-015-002</b>	WITH CHAIN, LARGE, 12mm



**MILLARD THUMB SINGLE HOOK**

Item Code	Description
<b>17-016-001</b>	STANDARD, 5mm



**MILLARD THUMB DOUBLE HOOK**

Item Code	Description
<b>17-017-001</b>	STANDARD, 17mm





**FREEMAN FLAP RETRACTOR**

Item Code	Description
<b>17-018-001</b>	8" (203mm) ½" (13mm)
<b>17-018-002</b>	8" (203mm) 1" (25mm)



**FREEMAN FLAP RETRACTOR FIBER OPTIC**

Item Code	Description
<b>17-019-001</b>	8" (203mm) ½" (13mm)
<b>17-019-002</b>	8" (203mm) 1" (25mm)



**SWIVEL DOUBLE HOOK/RETRACTOR**

Item Code	Description
<b>17-020-001</b>	2 SHARP PRONG WITH SWIVEL RING 3½" (89mm), 10mm



**MARTINEZ-KILNER NASAL RETRACTOR**

Item Code	Description
<b>17-021-001</b>	2 SHARP PRONGS WITH THUMB RING 4½" (114mm) 7.5mm



**SHEEN NASAL RETRACTOR**

Item Code	Description
<b>17-022-001</b>	ANGLED, 6½" (165mm), 10mm



**SHEEN RETRACTOR**

Item Code	Description
<b>17-023-001</b>	CURVED, 6¼" (159mm), 6.5mm



**FARABEUFR RETRACTOR**

Item Code	Description
<b>17-024-001</b>	STANDARD SET OF 2, 6" (152mm)



**U.S. ARMY RETRACTOR, SET OF 2**

Item Code	Description
<b>17-025-001</b>	8½" (216mm)



**DEAVER RETRACTOR,**

Item Code	Description
<b>17-026-001</b>	12" (305mm), 1" (25mm)



**RIBBON RETRACTOR**

Item Code	Description
<b>17-027-001</b>	INFANT, 6¾" (171mm), 5/8" (16mm)
<b>17-027-002</b>	PEDIATRIC, 8" (203mm), 5/8" (16mm)
<b>17-027-003</b>	PEDIATRIC, 8" (203mm), 1" (25mm)



**MEYERDING FINGER RETRACTOR**

Item Code	Description
<b>17-028-001</b>	STYLE 1, 7" (178mm), 18mmX7.5mm
<b>17-028-002</b>	STYLE 2, 7" (178mm), 16mmX5.5mm
<b>17-028-003</b>	STYLE 3, 7" (178mm), 8mmX4.5mm
<b>17-028-004</b>	STYLE 4, 7" (178mm), 10mmX3.5mm
<b>17-028-005</b>	STYLE 5, 7" (178mm), 8mmX4mm

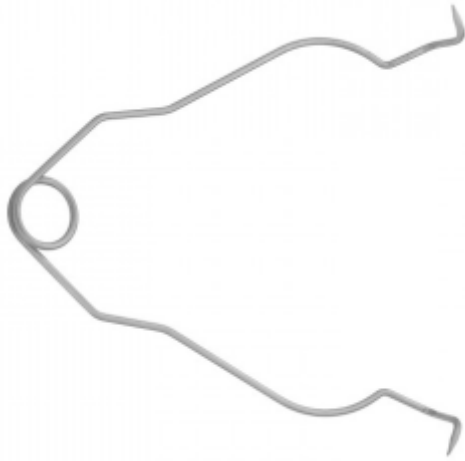

**FARR STYLE SPRING RETRACTOR**

Item Code	Description
<b>17-029-001</b>	SHARP POINTS, 1½" (38mm)
<b>17-029-002</b>	SHARP POINTS, 2" (51mm)
<b>17-029-003</b>	SHARP POINTS, 2¼" (57mm)
<b>17-029-004</b>	SHARP POINTS, 2½" (64mm)
<b>17-029-005</b>	SHARP POINTS, 3" (76mm)
<b>17-029-006</b>	SHARP POINTS, 2½" (64mm)



**ALM SELF-RETRAINING RETRACTOR**

Item Code	Description
<b>17-030-001</b>	4 X 4 BLUNT PRONGS, 2¾" (70mm)
<b>17-030-002</b>	4 X 4 SHARP PRONGS, 2¾" (70mm)
<b>17-030-003</b>	4 X 4 BLUNT PRONGS, 4" (102mm)



**HOLZHEIMER CROSS-ACTION RETRACTOR**

Item Code	Description
<b>17-031-001</b>	4 X 4 SHARP PRONGS, 4" (102mm)
<b>17-031-002</b>	4 X 4 BLUNT PRONGS, 4" (102mm)



**PAPARELLA-WEITLANER RETRACTOR**

Item Code	Description
<b>17-032-001</b>	2 X 2 SEMI-SHARP PRONGS 5" (127mm), 33mm INSIDE SPREAD

Cortical Cutter



**SHEPARD CORTICAL CUTTER**

Item Code	Description
<b>18-001-001</b>	12 cm/ 4 <sup>3</sup> / <sub>4</sub> "

For turning cylinder osteotomes



**SHEPARD FOR TURNING CYLINDER**

Item Code	Description
<b>18-002-001</b>	11 cm/ 4 3/8"



**CYLINDER OSTEOTOES, 12.5cm/5"**



Item Code	Description
<b>18-003-001</b>	Ø5mm
<b>18-003-002</b>	Ø6mm
<b>18-003-003</b>	Ø8mm

**RAM, 14cm/5½"**



Item Code	Description
<b>18-004-001</b>	Ø5mm
<b>18-004-002</b>	Ø6mm
<b>18-004-003</b>	Ø8mm

**TROCARS 14.5cm/5¾"**



Item Code	Description
<b>18-005-001</b>	Ø5mm
<b>18-005-002</b>	Ø6mm
<b>18-005-003</b>	Ø8mm



**UNIVERSAL T. C. WIRE CUTTING SCISSORS**

Item Code	Description
<b>19-001-001</b>	12CM



**NIRO T.C. WIRE TWISTING FORCEPS**

Item Code	Description
<b>19-002-001</b>	15CM



**NAGATA AURICULAR SEPTUM ELEVATOR**

Item Code	Description
<b>19-003-001</b>	16CM, BLUNT
<b>19-003-002</b>	17CM, BLUNT



**DOYEN RIB RASPATORY, 17CM**

Item Code	Description
<b>19-004-001</b>	RIGHT
<b>19-004-002</b>	LEFT



**KISTLER ANTHELIX CARTILAGE RASP**

Item Code	Description
<b>19-005-001</b>	RIGHT
<b>19-005-002</b>	LEFT





**MAYO SCISSORS**

Item Code	Description
<b>20-001-001</b>	SUPERCUT PLUS T.C. (TUNGSTEN CARBIDE) 17CM, CURVED



**COTTLE CARTILAGE CRUSHER**

Item Code	Description
<b>20-002-001</b>	WITH CLAMP, FOR TAKING OUT THE PREPARED MATERIAL, 65X30X30MM



**CARTILAGE CUTTING BLOCK**

Item Code	Description
<b>20-003-001</b>	TEFLON, 85X55X10MM



**GUBISCH CARTILAGE CRUSHER**

Item Code	Description
<b>20-004-001</b>	65X30MM

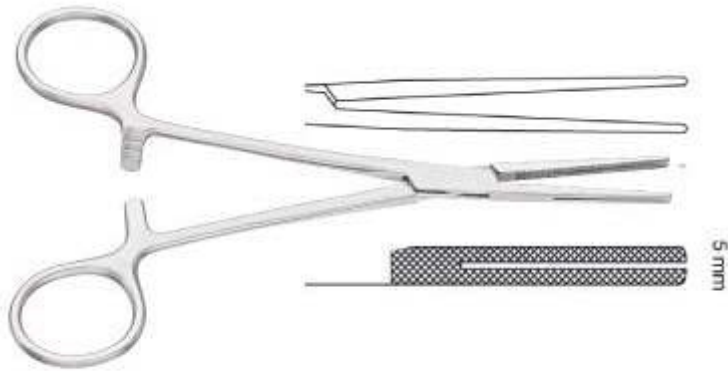

**AIACH FORCEPS**

Item Code	Description
<b>20-005-001</b>	16CM, 5MM TIP



**DINGMAN CARTILAGE ABRADERS**

Item Code	Description
<b>20-006-001</b>	SET OF TWO



**RUBIN SEPTAL MORSELIZER FORCEPS**

Item Code	Description
<b>20-007-001</b>	21CM



**RUBIN SEPTAL MORSELIZER FORCEPS**

Item Code	Description
<b>20-008-001</b>	T.C. (TUNGSTEN CARBIDE) 20CM





**BONE MILL**

Item Code	Description
<u>20-009-001</u>	<u>WITH ASSEMBLING WRENCH</u>



**HUMBY DERMATOME KNIFE, ADJUSTABLE**

Item Code	Description
<b>21-001-001</b>	COMPLETE WITH WOODEN BOX, 32CM



Item Code	Description
<b>21-002-001</b>	<b>SPARE BLADE FOR HUMBY AND WATSON DERMATOME</b>



**WATSON DERMATOME**

Item Code	Description
<b>21-003-001</b>	(SKIN GRAFT KNIFE)



**SCHINK DERMATOME**

Item Code	Description
<b>21-004-001</b>	30CM, ADJUSTABLE

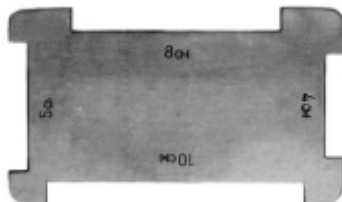

**SKIN HOLDING/STRETCHING PLATE**

Item Code	Description
<b>21-005-001</b>	FOR SCHINK DERMATOME



**SILVER DERMATOME**

Item Code	Description
<b>21-006-001</b>	19CM, ADJUSTABLE



**LIP RETRACTOR**

Item Code	Description
<b>22-001-001</b>	FOR UPPER JAW, 21CM



**LIP RETRACTOR**

Item Code	Description
<b>22-002-001</b>	FOR LOWER JAW, 26CM

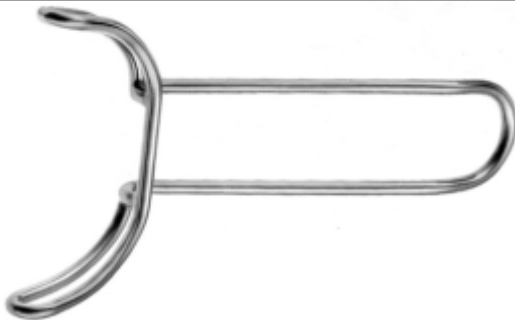

**VESTIBULUM (UNIVERSAL) RETRACTOR**

Item Code	Description
<b>22-003-001</b>	15CM

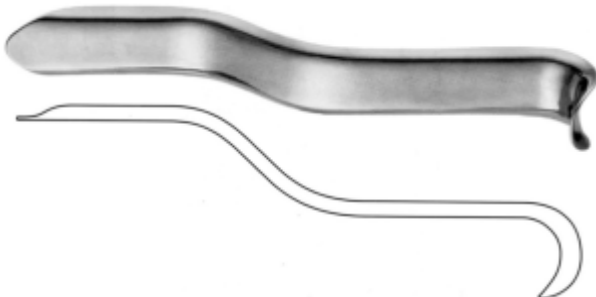

**UNIVERSITY OF MINNESOTA CHEEK  
RETRACTOR**

Item Code	Description
<b>22-034-001</b>	15.5CM

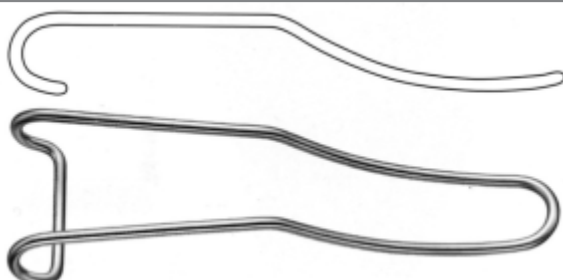

**STERNBERG CHEEK RETRACTOR**

Item Code	Description
<b>22-035-001</b>	14.5CM



**BLOCKSMA CLEFT PALATE HOOK, 18CM**

Item Code	Description
<b>23-001-001</b>	1 PRONG
<b>23-001-002</b>	3MM, 2 PRONG

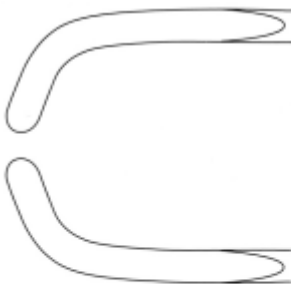

**CLEFT PALATE RASPATORY, 14CM**

Item Code	Description
<b>23-002-001</b>	#1 LEFT
<b>23-002-002</b>	#2 RIGHT



**KAHRE CLEFT PALATE RASPATORY**

Item Code	Description
<b>23-003-001</b>	17CM



**MCINDOE CLEFT PALATE RASPATORY**

Item Code	Description
<b>23-004-001</b>	16.5CM



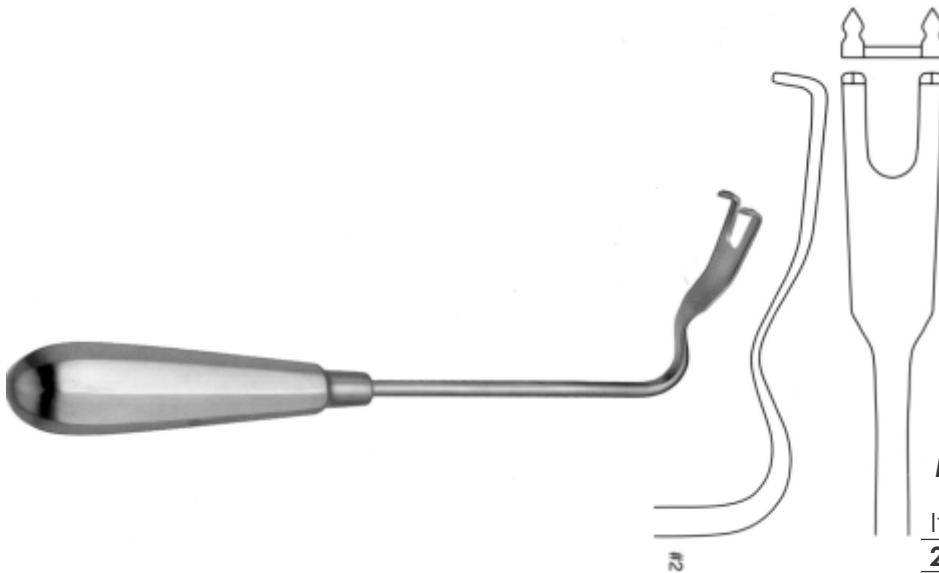

**MUCOPERIOSTEAL RETRACTOR**

Item Code	Description
<b>23-005-001</b>	19CM

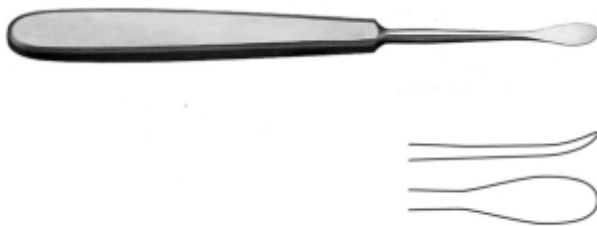

**WANG CLEFT PALATE ELEVATOR**

Item Code	Description
<b>23-006-001</b>	15.5CM

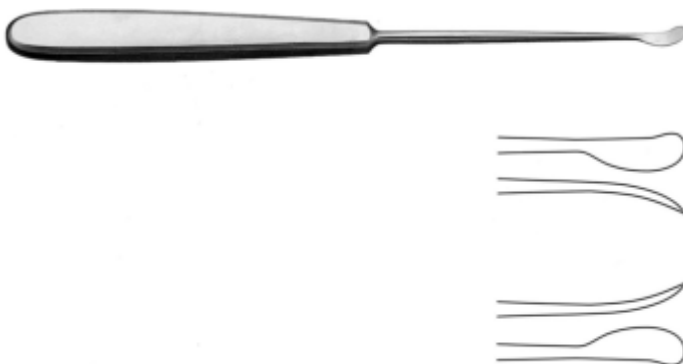

**WANG CLEFT PALATE ELEVATOR, 18CM**

Item Code	Description
<b>23-007-001</b>	RIGHT
<b>23-007-002</b>	LEFT
<b>23-007-003</b>	RIGHT ANGLED
<b>23-007-004</b>	LEFT ANGLED

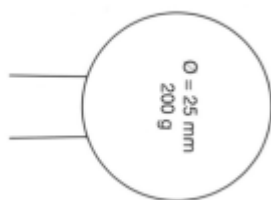

**MALLET**

Item Code	Description
<b>24-001-001</b>	18.5CM, PLASTIC FACINGS, 200 GRAMS, 25MM DIAMETER



**MALLET, 26CM, NOVOTEX PLASTIC**

Item Code	Description
<b>24-002-001</b>	150 GRAMS, 35MM DIAMETER
<b>24-002-002</b>	240 GRAMS, 45MM DIAMETER
<b>24-002-003</b>	330 GRAMS, 50MM DIAMETER



**COTTLE MALLET, 19CM**

Item Code	Description
<b>24-003-001</b>	1 PLAIN FACE, 1 CONVEX FACE

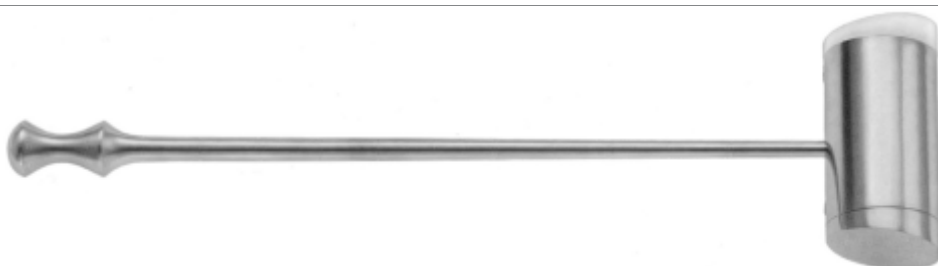

**QUILLEN METAL HAMMER, 24CM**

Item Code	Description
<b>24-004-001</b>	300 GRAMS, 30MMØ, ANGLED FACES

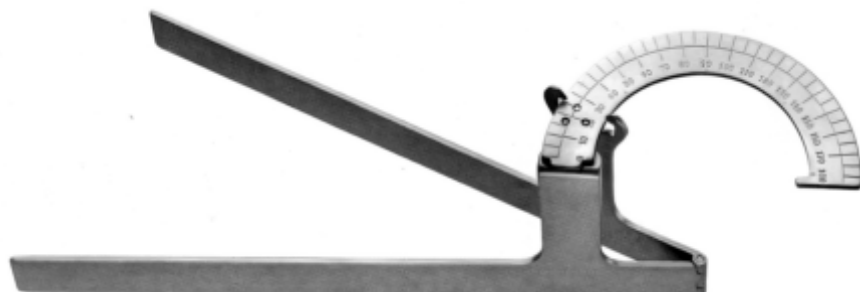

**MOLTGEN FLEXOMETER**

Item Code	Description
<b>25-001-001</b>	24CM



**FINGER GONIOMETER**

Item Code	Description
<b>25-002-001</b>	13CM



**KNOCHEN MESSZIRKEL BONE BOW SPACER**

Item Code	Description
<b>25-003-001</b>	19.5CM, SHARP TIPS

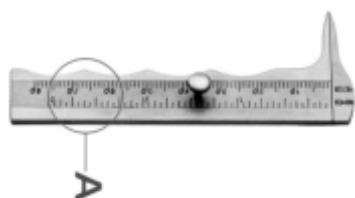

**JAMESON CALIPER**

Item Code	Description
<b>25-004-001</b>	10CM



**THORPE CALIPER, 11CM**

Item Code	Description
<b>25-005-001</b>	80MM MEASURING RANGE



**CASTROVIEJO CALIPER, 8CM**

Item Code	Description
<b>25-006-001</b>	20MM MEASURING RANGE



**CASTROVIEJO CALIPER, 9CM**

Item Code	Description
<b>25-007-001</b>	40MM MEASURING RANGE



**CASTROVIEJO EPKER CALIPER, 18CM**

Item Code	Description
<b>25-008-001</b>	STRAIGHT, 40MM MEASURING RANGE



**CASTROVIEJO EPKER CALIPER, 18CM**

Item Code	Description
<b>25-009-001</b>	ANGLED, 40MM MEASURING RANGE

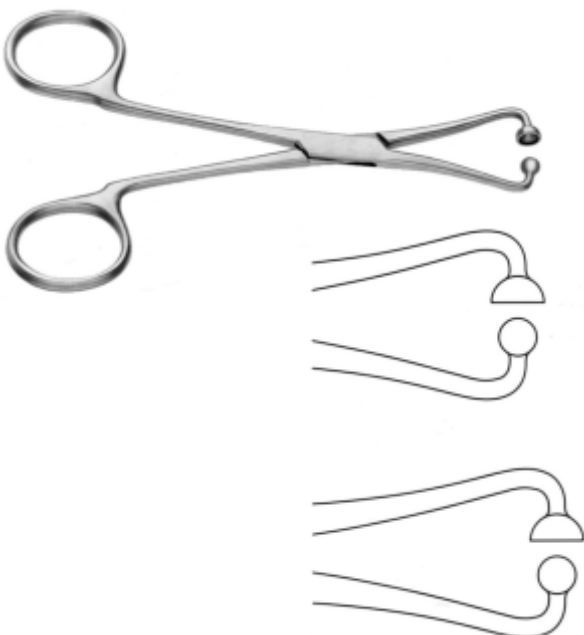

**NOSE TIP MARKER**

Item Code	Description
<b>25-010-001</b>	12CM, STRAIGHT
<b>25-010-002</b>	14.5CM, STRAIGHT





**JOSEPH MEASURING ROD, 17CM**

Item Code	Description
<b>25-011-001</b>	GRADUATED IN MILLIMETERS

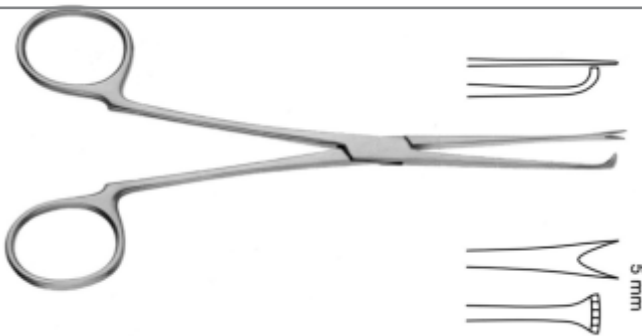

**PITANGUY FACELIFT MARKER, 16CM**

Item Code	Description
<b>25-012-001</b>	5MM WIDE



**MARTEN FLAP MARKER, 5 3/4" (14.5 CM)**

Item Code	Description
<b>25-013-001</b>	WITH RATCHET
<b>25-013-002</b>	WITHOUT RATCHET

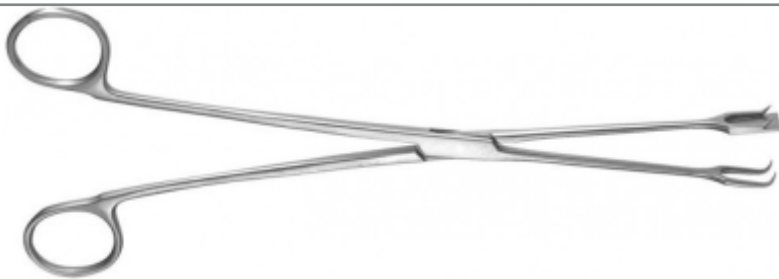

**D ASSUMPCAO ABDOMINAL FLAP MARKER**

Item Code	Description
<b>25-014-001</b>	10 MM WIDTH, 10" (254 MM) LENGTH



**LOCKWOOD ABDOMINAL DEMARCATOR**

Item Code	Description
<b>25-015-001</b>	11 MM WIDTH, WITH ANGLED HINGE, 12 1/4" (311 MM) LENGTH

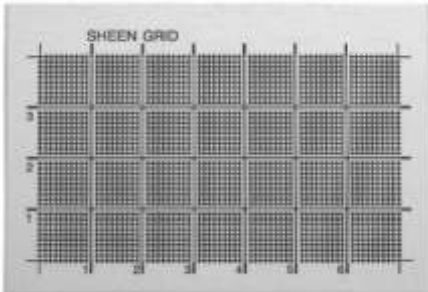

**Sheen Grid** Stainless Steel

Item Code	Description
<b>25-016-001</b>	Autoclavable, Grid Dimensions are 40 X 70 mm



**NAVAL MARKER**

Item Code	Description
<b>25-017-001</b>	11 3/8" (29cm)

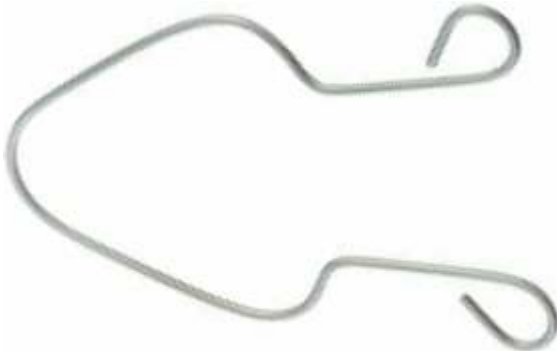

**ACKERMAN BREAST MARKER**

Item Code	Description
<b>25-018-001</b>	5 1/2" (14 CM), SMALL
<b>25-018-002</b>	6 1/4" (16 CM), LARGE



**MCKISSOCK KEYHOLE PATTERN**

Item Code	Description
<b>25-019-001</b>	38 MM DIAMETER, WITH CM MARKINGS
<b>25-019-002</b>	42 MM DIAMETER, WITH CM MARKINGS
<b>25-019-003</b>	45 MM, DIAMETER, WITH CM MARKINGS

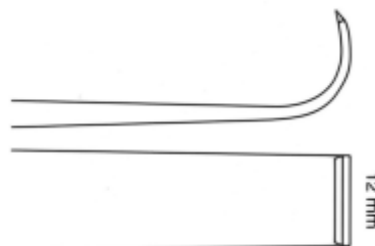

**OBWEGESER MAXILLA  
MOBILIZING INSTRUMENT**

Item Code	Description
<b>25-020-001</b>	23CM, 12MM

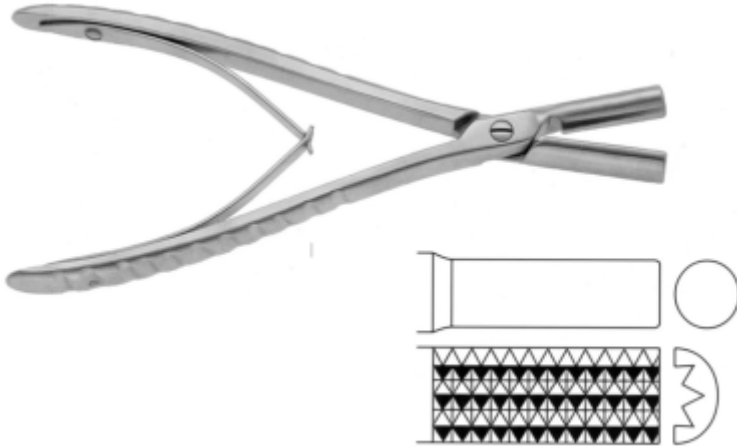

**OBWEGESER, BONE BENDING PLIERS**

Item Code	Description
<b>26-001-001</b>	17.5cm/7"

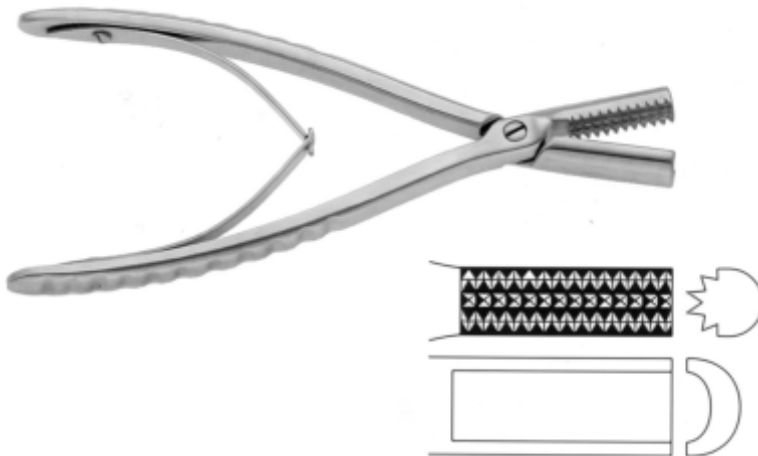

**OBWEGESER, BONE BENDING PLIERS**

Item Code	Description
<b>26-002-001</b>	17.5cm/7"

Septal Morslizer Forceps  
with protective guard

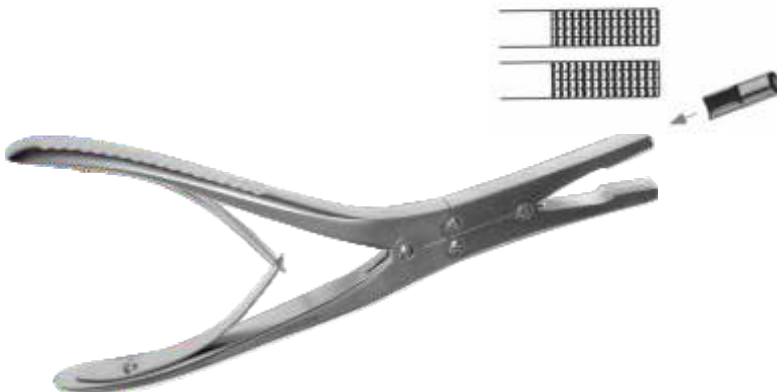

**RUBIN FORCEPS**

Item Code	Description
<b>26-003-001</b>	20cm/8"



# GENERAL SURGERY INSTRUMENTS



**SCALPEL HANDLE, NO.3**

Item Code	Description
<b>27-001-001</b>	12.5cm/5"



**SCALPEL HANDLE, NO.7**

Item Code	Description
<b>27-002-001</b>	16.5cm/6½"



**SCALPEL HANDLE, NO.7K**

Item Code	Description
<b>27-003-001</b>	12cm/4¾"



**SCALPEL HANDLE, NO.3L**

Item Code	Description
<b>27-004-001</b>	21cm/8¼"



**SCALPEL HANDLE, NO.3LA**

Item Code	Description
<b>27-005-001</b>	20.5cm/8"



**ROUND SCALPEL HANDLE**

Item Code	Description
<b>27-006-001</b>	15.5cm/6 1/8"

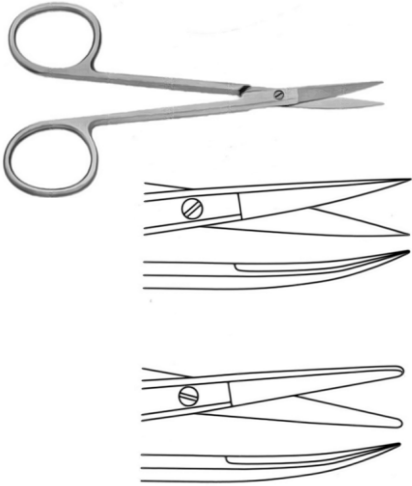

**COTTE MASING RHINOPLASTY  
SCISSORS, 10CM, CURVED BLADE**

Item Code	Description
<b>29-001-001</b>	SHARP
<b>29-001-001</b>	BLUNT



**COTTE BULLDOG SCISSORS**

Item Code	Description
<b>29-002-001</b>	11.5CM



**CONVERSE SCISSORS**

Item Code	Description
<b>29-003-001</b>	13.5CM, DOUBLE EDGED, OUTER EDGES SEMI SHARP

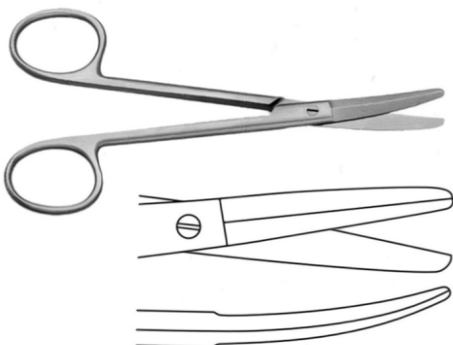

**FOMON RHINOPLASTY SCISSORS, 12.5CM**

Item Code	Description
<b>29-004-001</b>	WITH OUTER CUTTING, BOTH SIDES SHARP

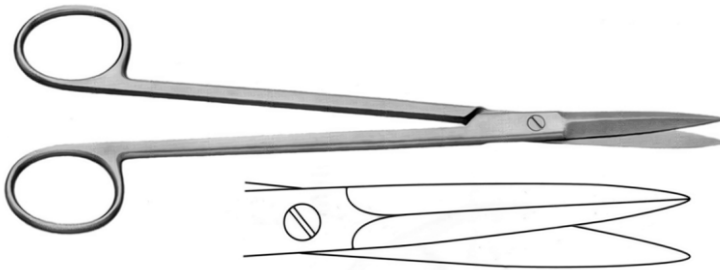

**MCINDOE RHINOPLASTY SCISSORS**

Item Code	Description
<b>29-005-001</b>	19CM, STRAIGHT, SERRATED

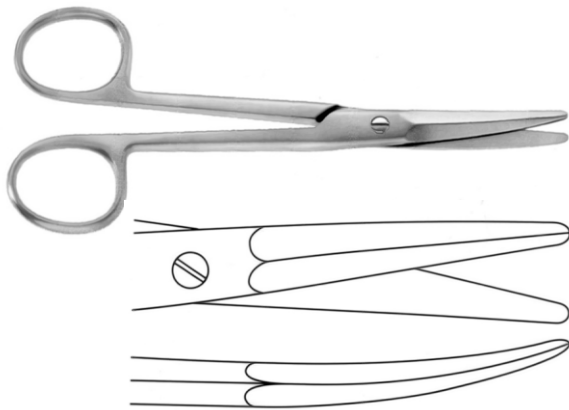

**AUFRICHT NASAL SCISSORS, 14CM, BLUNT**

STANDARD	SUPERCUT	TC	SUPERCUT PLUS
<b>29-006-001</b>	<b>29-006-002</b>	<b>29-006-003</b>	<b>29-006-004</b>



**GIUNTA T.C. NASAL SCISSORS**

Item Code	Description
<b>29-007-001</b>	13.5CM, CURVED

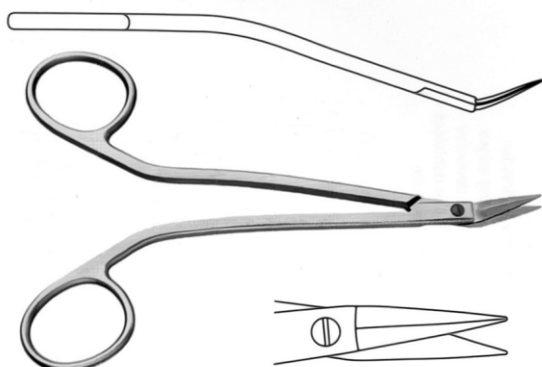

**WALTER DORSAL SCISSORS 14CM, ANGULAR**

STANDARD	SUPERCUT	TC	SUPERCUT PLUS
<b>29-008-001</b>	<b>29-008-002</b>	<b>29-008-003</b>	<b>29-008-004</b>

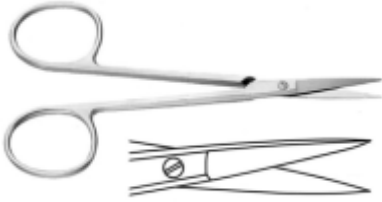

**IRIS SCISSORS, STRAIGHT**

	STANDARD	SUPERCUT	TC	SUPERCUT PLUS
3½" (9cm)	<b>29-009-001</b>	<b>29-009-005</b>	<b>29-009-009</b>	<b>29-009-013</b>
4¼" (10.5cm)	<b>29-009-002</b>	<b>29-009-006</b>	<b>29-009-010</b>	<b>29-009-014</b>
4½" (11.5cm)	<b>29-009-003</b>	<b>29-009-007</b>	<b>29-009-011</b>	<b>29-009-015</b>
5" (12.5cm)	<b>29-009-004</b>	<b>29-009-008</b>	<b>29-009-012</b>	<b>29-009-016</b>



**IRIS SCISSORS, CURVED**

	STANDARD	SUPERCUT	TC	SUPERCUT PLUS
3½" (9cm)	<b>29-010-001</b>	<b>29-010-005</b>	<b>29-010-009</b>	<b>29-010-013</b>
4¼" (10.5cm)	<b>29-010-002</b>	<b>29-010-006</b>	<b>29-010-010</b>	<b>29-010-014</b>
4½" (11.5cm)	<b>29-010-003</b>	<b>29-010-007</b>	<b>29-010-011</b>	<b>29-010-015</b>
5" (12.5cm)	<b>29-010-004</b>	<b>29-010-008</b>	<b>29-010-012</b>	<b>29-010-016</b>

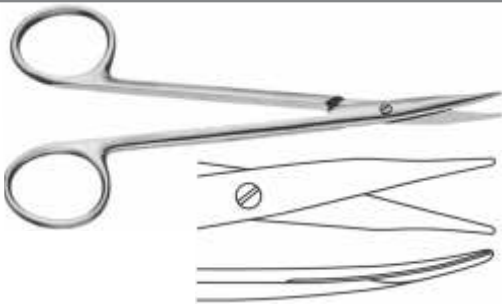

**STEVEN SCISSORS, 5 1/8" (13cm)**

STANDARD	SUPERCUT
<b>29-011-001</b>	<b>29-011-002</b>



**MAYO SCISSORS, STRIAGHT**

	STANDARD	SUPERCUT	TC	SUPERCUT PLUS
14 cm	<b>29-012-001</b>	<b>29-012-03</b>	<b>29-012-05</b>	<b>29-012-07</b>
17 cm	<b>29-012-002</b>	<b>29-012-04</b>	<b>29-012-06</b>	<b>29-012-08</b>

**MAYO SCISSORS, STRIAGHT**

	STANDARD	SUPERCUT	TC	SUPERCUT PLUS
14 cm	<b>29-012-009</b>	<b>29-012-11</b>	<b>29-012-13</b>	<b>29-012-15</b>
17 cm	<b>29-012-010</b>	<b>29-012-12</b>	<b>29-012-14</b>	<b>29-012-16</b>





**MAYO STILLE SCISSORS**

	STANDARD	SUPERCUT	TC	SUPERCUT PLUS
15 cm	<b>29-013-001</b>	<b>29-013-03</b>	<b>29-013-05</b>	<b>29-013-07</b>
17 cm	<b>29-013-002</b>	<b>29-013-04</b>	<b>29-013-06</b>	<b>29-013-08</b>



**METZENBAUM SCISSORS**

	STANDARD	SUPERCUT	TC	SUPERCUT PLUS
14 cm	<b>29-014-001</b>	<b>29-014-004</b>	<b>29-014-007</b>	<b>29-014-010</b>
18 cm	<b>29-014-002</b>	<b>29-014-005</b>	<b>29-014-008</b>	<b>29-014-011</b>
20 cm	<b>29-014-003</b>	<b>29-014-006</b>	<b>29-014-009</b>	<b>29-014-012</b>



**NELSON METZENBAUM SCISSORS**

	STANDARD	SUPERCUT	TC	SUPERCUT PLUS
23 cm	<b>29-015-001</b>	<b>29-015-004</b>	<b>29-015-007</b>	<b>29-015-010</b>
26 cm	<b>29-015-002</b>	<b>29-015-005</b>	<b>29-015-008</b>	<b>29-015-011</b>
30 cm	<b>29-015-003</b>	<b>29-015-006</b>	<b>29-015-009</b>	<b>29-015-012</b>



**FANOUS SCISSORS**

	STRIAGHT STANDARD	STRIAGHT SUPERCUT	CURVED STANDARD	CURVED SUPERCUT
16.5 cm	<b>29-016-001</b>	<b>29-016-003</b>	<b>29-016-005</b>	<b>29-016-007</b>
20.5 cm	<b>29-016-002</b>	<b>29-016-004</b>	<b>29-016-006</b>	<b>29-016-008</b>



**GORNEY SCISSORS**

	STANDARD	SUPERCUT	TC	SUPERCUT PLUS
17 cm	<b>29-017-001</b>	<b>29-017-004</b>	<b>29-017-007</b>	<b>29-017-010</b>
19 cm	<b>29-017-002</b>	<b>29-017-005</b>	<b>29-017-008</b>	<b>29-017-011</b>
23 cm	<b>29-017-003</b>	<b>29-017-006</b>	<b>29-017-009</b>	<b>29-017-012</b>

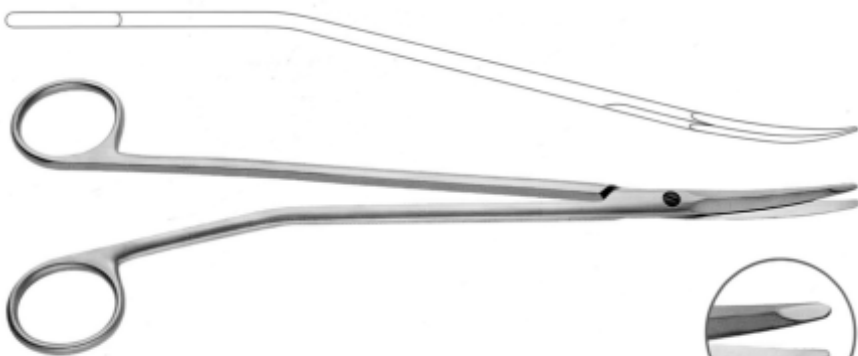

**GORNEY FREEMAN SCISSORS**

	STANDARD	SUPERCUT	TC	SUPERCUT PLUS
23 cm	<b>29-018-001</b>	<b>29-018-002</b>	<b>29-018-003</b>	<b>29-018-004</b>

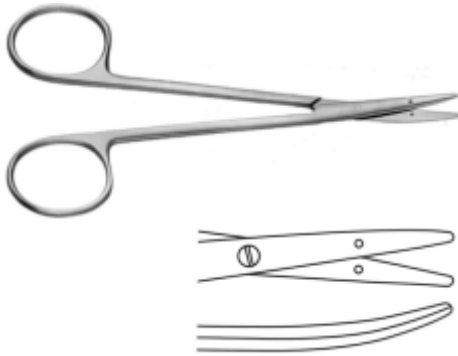

**LITTLER SCISSORS,**

Item Code	Description
<b>X27-019-001</b>	<b>STANDARD, 4<sup>3</sup>/<sub>4</sub>" (12cm)</b>

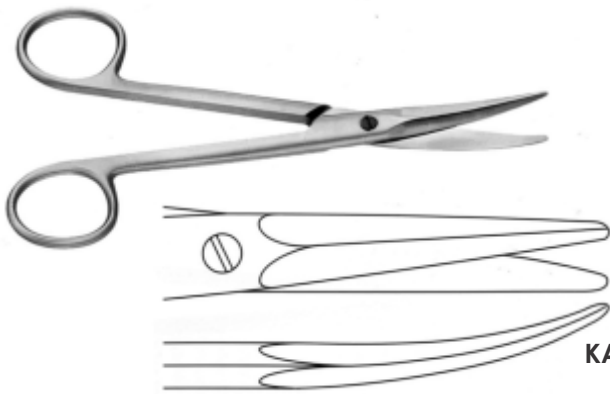

**KAYE SCISSORS**

	STANDARD	SUPERCUT	TC	SUPERCUT PLUS
15 cm	<b>29-020-001</b>	<b>29-020-003</b>	<b>29-020-005</b>	<b>29-020-007</b>
17 cm	<b>29-020-002</b>	<b>29-020-004</b>	<b>29-020-006</b>	<b>29-020-008</b>

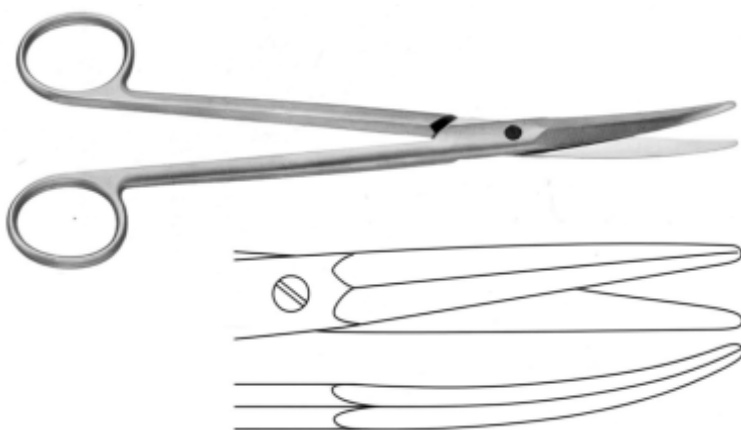

**KAYE SCISSORS**

	STANDARD	SUPERCUT	TC	SUPERCUT PLUS
19 cm	<b>29-021-001</b>	<b>29-021-003</b>	<b>29-021-005</b>	<b>29-021-007</b>
23 cm	<b>29-021-002</b>	<b>29-021-004</b>	<b>29-021-006</b>	<b>29-021-008</b>



**BLEPHAROPLASTY SCISSORS**

Item Code	Description
<b>X27-023-001</b>	<b>SUPERCUT, 4½" (11.5cm)</b>

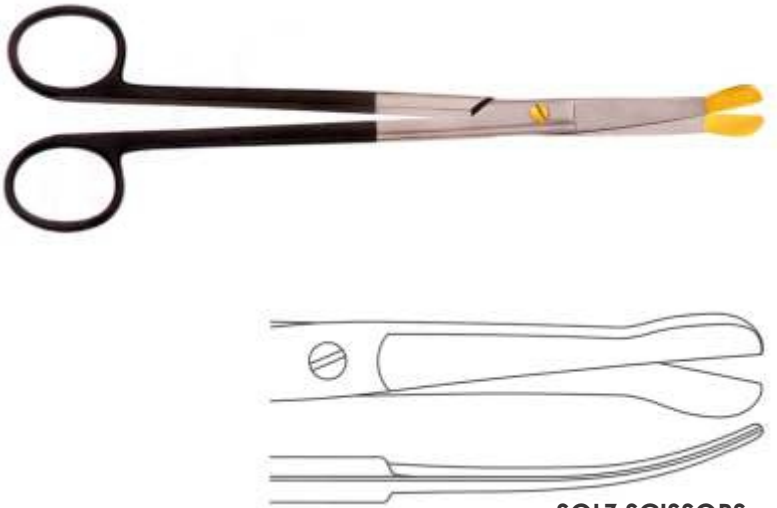

**SOLZ SCISSORS**

	STANDARD	SUPERCUT	TC	SUPERCUT PLUS
20 cm	<b>29-024-001</b>	<b>29-024-002</b>	<b>29-024-003</b>	<b>29-024-004</b>

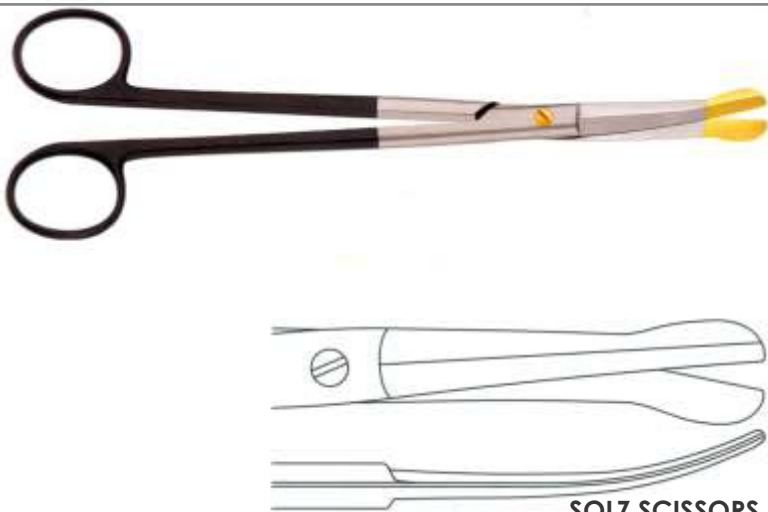

**SOLZ SCISSORS**

	STANDARD	SUPERCUT	TC	SUPERCUT PLUS
20 cm	<b>29-025-001</b>	<b>29-025-002</b>	<b>29-025-003</b>	<b>29-025-004</b>

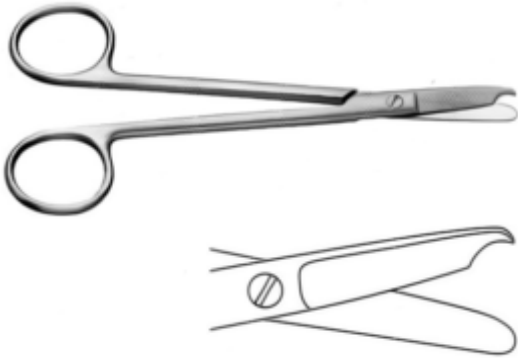

**LITTAUER SCISSORS**

Item Code	Description
<b>29-026-001</b>	5 1/8" (13cm)



serrated cutting edge  
wire cutting scissors

hard wire	∅ 0.8mm max
soft wire	∅ 1.2mm max

**UNIVERSAL SCISSORS**

Item Code	Description
<b>29-027-001</b>	4 3/4" (12cm)

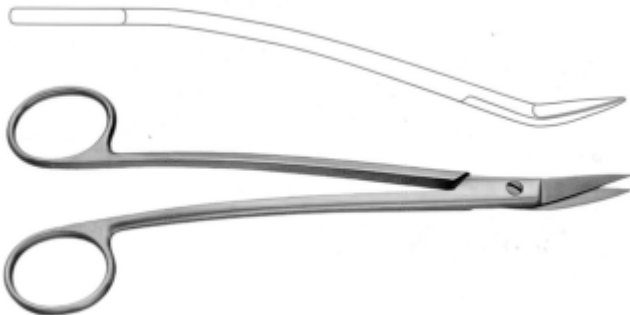

**DEAN SCISSORS**

	STANDARD	SUPERCUT
17 cm	<b>29-028-001</b>	<b>29-028-002</b>



**HEYMANN SCISSORS**

	STANDARD	SUPERCUT
17 cm	<b>29-029-001</b>	<b>29-039-002</b>

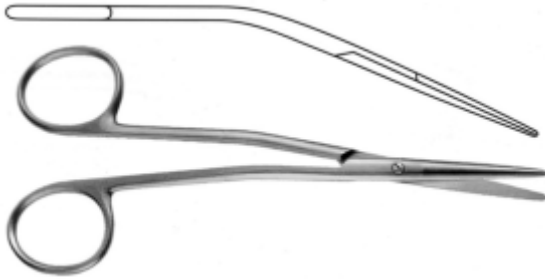

**FOMON SCISSORS**

	STANDARD	SUPERCUT	TC	SUPERCUT PLUS
13 cm	<b>29-030-001</b>	<b>29-030-002</b>	<b>29-030-003</b>	<b>29-030-004</b>



**WALTER SCISSORS**

	STANDARD	SUPERCUT
14 cm	<b>29-031-001</b>	<b>29-031-002</b>

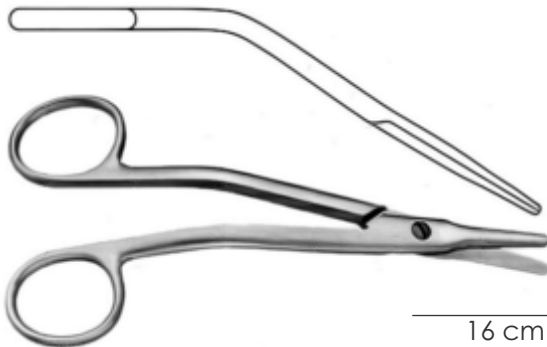

**WALTER COTTLE SCISSORS**

	STANDARD	SUPERCUT	TC	SUPERCUT PLUS
16 cm	<b>29-032-001</b>	<b>29-032-002</b>	<b>29-032-003</b>	<b>29-032-004</b>

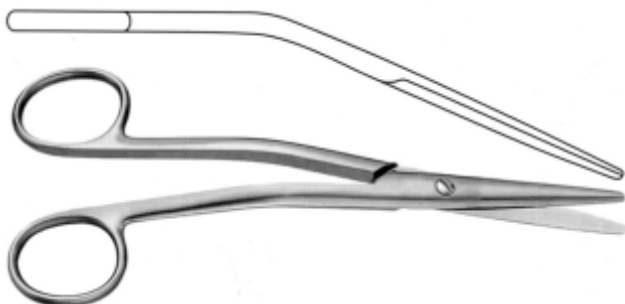

**COTTLE SCISSORS**

	STANDARD	SUPERCUT	TC	SUPERCUT PLUS
16 cm	<b>29-033-001</b>	<b>29-033-002</b>	<b>29-033-003</b>	<b>29-033-004</b>

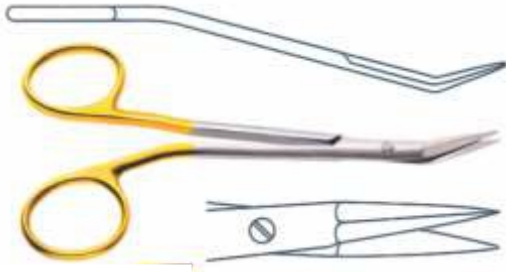

**GIUNTA SCISSORS**

	STANDARD	SUPERCUT	TC	SUPERCUT PLUS
13.5 cm	<b>29-034-001</b>	<b>29-034-002</b>	<b>29-034-003</b>	<b>29-034-004</b>

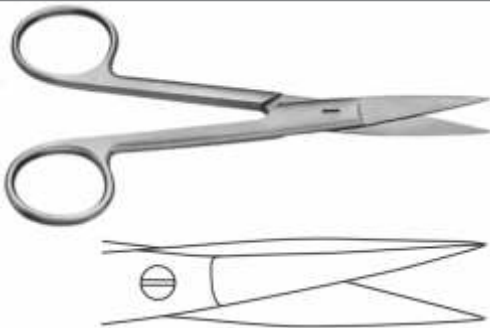

outer edges  
semi sharp

**CONVERSE SCISSORS**

	STANDARD	SUPERCUT	TC	SUPERCUT PLUS
13.5 cm	<b>29-035-001</b>	<b>29-035-002</b>	<b>29-035-003</b>	<b>29-035-004</b>



**COTTLE MASING SCISSORS, 10 CM**

	STANDARD
SHARP	<b>29-036-001</b>
BLUNT	<b>29-036-002</b>



Bulldog Scissors

**COTTLE SCISSORS, 11.5 CM**

	STANDARD
11.5 cm	<b>29-037-001</b>

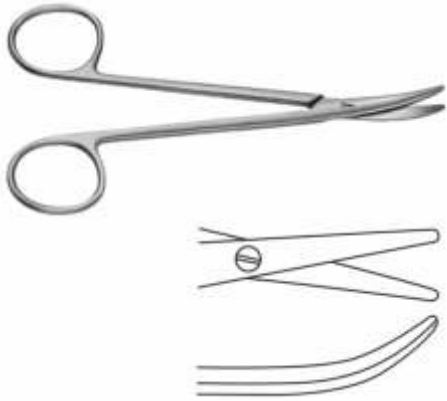

**CINELLI SCISSORS**

	STANDARD
11 cm	<b>29-038-001</b>



with outer cutting,  
both sides sharp

**FOMON SCISSORS**

	STANDARD
12.5 cm	<b>29-039-001</b>



serrated cutting edge

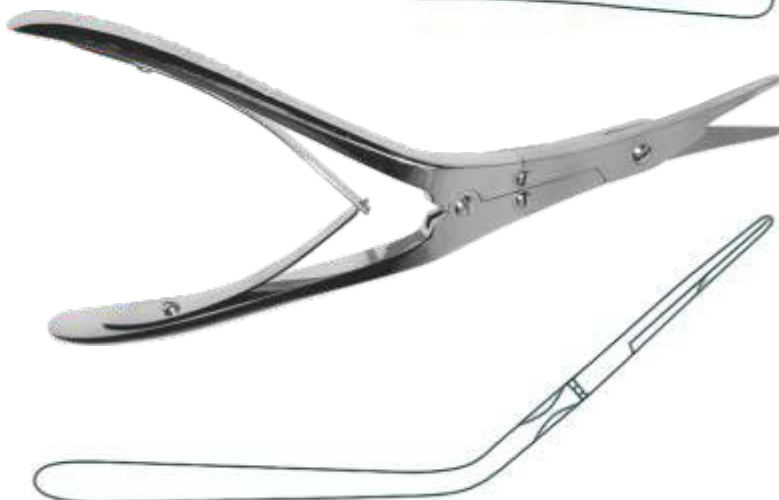

Nasal Septum Scissors

**CAPLAN SCISSORS**

Item Code	Description
<b>29-040-001</b>	20cm/ 8"





**TISSUE FORCEPS**

Item Code	Description
<b>30-001-001</b>	14.5cm/5 ¾"



**ADSON FORCEPS**

Item Code	Description
<b>30-002-001</b>	12cm/4 ¾"



**ADSON FORCEPS,TC**

Item Code	Description
<b>30-003-001</b>	12cm/4 ¾"



**ADSON FORCEPS,TC**

Item Code	Description
<b>30-004-001</b>	15cm/6"



**HUDSON-EWALD FORCEPS**

Item Code	Description
<b>30-005-001</b>	SERRATED, 12cm/4¾"



**HUDSON-EWALD FORCEPS**

Item Code	Description
<b>30-006-001</b>	1X2 TEETH, 12cm/4¾"



**ADSON FORCEPS**

Item Code	Description
<b>30-007-001</b>	1X2 TEETH, 15cm/6"



**ADSON FORCEPS, TC**

Item Code	Description
<b>30-008-001</b>	1X2 TEETH, 12cm/4¾"



**ADSON FORCEPS, TC**

Item Code	Description
<b>30-009-001</b>	1X2 TEETH, 15cm/6"



**ADSON BROWN FORCEPS, 12cm/4¾"**

Item Code	Description
<b>30-010-001</b>	7X7 TEETH
<b>30-010-002</b>	9X9 TEETH



**ADSON BROWN FORCEPS**

Item Code	Description
<b>30-011-001</b>	12cm/ 4¾"



**ADSON GRAEFE BROWN FORCEPS**

Item Code	Description
<b>30-012-001</b>	12cm/ 4¾"



**SEMKEN FORCEPS**

Item Code	Description
<b>30-013-001</b>	12.5cm/ 5"



**SEMKEN FORCEPS**

Item Code	Description
<b>30-014-001</b>	SERRATED, STRAIGHT, 12.5cm/5"
<b>30-014-002</b>	SERRATED, CURVED, 12.5cm/5"
<b>30-014-003</b>	SERRATED, STRAIGHT, 15cm/6"
<b>30-014-004</b>	SERRATED, CURVED, 15cm/6"

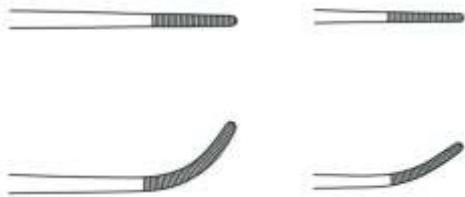

**SEMKEN FORCEPS**

Item Code	Description
<b>30-015-001</b>	1X2 TEETH, STRAIGHT, 12.5cm/5"
<b>30-015-002</b>	1X2 TEETH, CURVED, 12.5cm/5"
<b>30-015-003</b>	1X2 TEETH, STRAIGHT, 15cm/6"
<b>30-015-004</b>	1X2 TEETH, CURVED, 15cm/6"

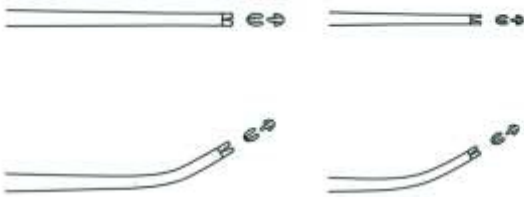

**MCINDOE FORCEPS**

Item Code	Description
<b>30-016-001</b>	SERRATED, 15cm/6"



**GILLIES FORCEPS**

Item Code	Description
<b>30-017-001</b>	SERRATED, 1X2 TEETH, 15cm/6"



**WAUGH FORCEPS**

Item Code	Description
<b>30-018-001</b>	CROSS SERRATION, 15cm/6"
<b>30-018-002</b>	CROSS SERRATION, 1X2 TEETH, 15cm/6"





Item Code	Description
<b>30-019-001</b>	<b>FORCEPS, SERRATED, 20cm/8"</b>



**DEBAKEY "AT" FORCEPS**

Item Code	Description
<b>30-020-001</b>	<b>15cm/6"</b>

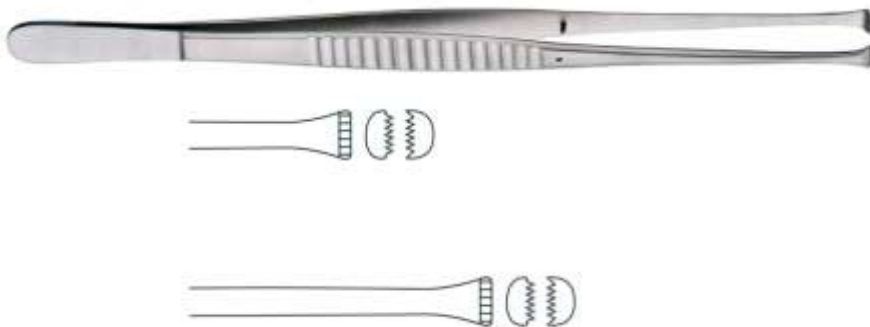

**NELSON FORCEPS**

Item Code	Description
<b>30-021-001</b>	<b>15cm/6"</b>
<b>30-021-002</b>	<b>23cm/9"</b>



**WALTER FORCEPS**

Item Code	Description
<b>30-022-001</b>	<b>16m/6¼"</b>



**WALTER FORCEPS**

Item Code	Description
<b>30-023-001</b>	<b>16m/6¼"</b>



Bayonet Forceps

**GRUENWALD FORCEPS**

Item Code	Description
<b>30-023-001</b>	16 cm/ 6 1/4"



**TROELTSCH (WILDE) FORCEPS**

Item Code	Description
<b>30-024-001</b>	13 cm/ 5 1/8"



Lip Grasping Forceps

**WALTER FORCEPS**

Item Code	Description
<b>30-025-001</b>	8 cm/ 3 1/8"



**COTTLE FORCEPS**

Item Code	Description
<b>30-026-001</b>	15 cm/ 6"



with catch

**FOX FORCEPS**

Item Code	Description
<b>30-027-001</b>	15 cm/ 6"





**HALSTED MOSQUITO FORCEPS**

Item Code	Description
<b>31-001-001</b>	STRAIGHT 12.5cm/5"
<b>31-001-002</b>	CURVED 12.5cm/5"

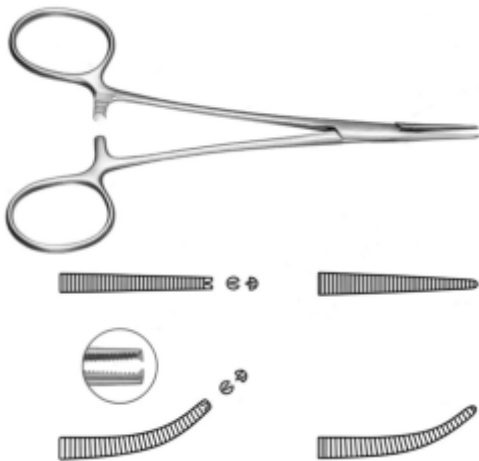

**MICRO MOSQUITO FORCEPS**

Item Code	Description
<b>31-002-001</b>	STRAIGHT 12.5cm/5"
<b>31-002-002</b>	CURVED 12.5cm/5"
<b>31-002-003</b>	STRAIGHT, 1X2 TEETH, 12.5cm/5"
<b>31-002-004</b>	CURVED, 1X2 TEETH, 12.5cm/5"



Atraumatic Serration

**MOSQUITO "AT" FORCEPS**

Item Code	Description
<b>31-003-001</b>	STRAIGHT 12.5cm/5"
<b>31-003-002</b>	CURVED 12.5cm/5"



**MICRO JACOBSON FORCEPS**

Item Code	Description
<b>31-004-001</b>	STRAIGHT 12.5cm/5"
<b>31-004-002</b>	CURVED 12.5cm/5"

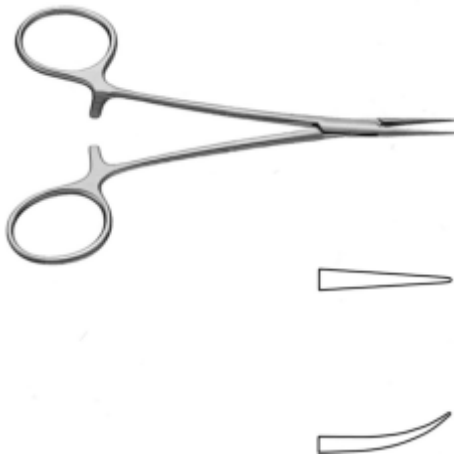

**MICRO JACOBSON FORCEPS**

Item Code	Description
<b>31-005-001</b>	STRAIGHT 12.5cm/5"
<b>31-005-002</b>	CURVED 12.5cm/5"

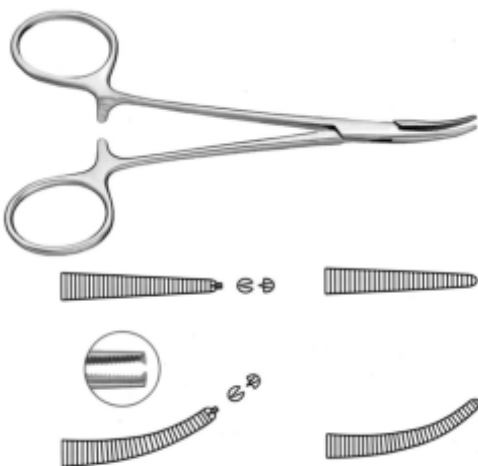

**HALSTED MOSQUITO FORCEPS**

Item Code	Description
<b>31-006-001</b>	STRAIGHT 10cm/4"
<b>31-006-002</b>	CURVED 10cm/4"
<b>31-006-003</b>	STRAIGHT, 1X2 TEETH, 12.5cm/5"
<b>31-006-004</b>	CURVED, 1X2 TEETH, 12.5cm/5"



**PROVIDENCE HOSPITAL FORCEPS, 14cm/5½"**

Item Code	Description
<b>31-007-001</b>	STRAIGHT
<b>31-007-002</b>	CURVED,
<b>31-007-003</b>	STRAIGHT, 1X2 TEETH
<b>31-007-004</b>	CURVED, 1X2 TEETH

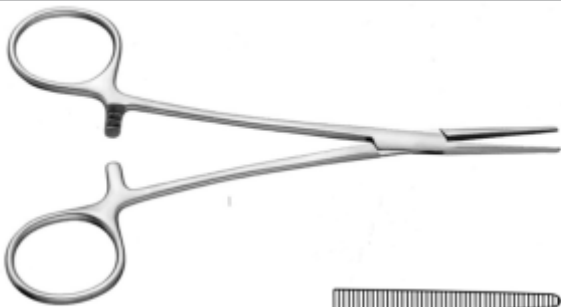

**LERICHE FORCEPS, 15cm/ 6"**

Item Code	Description
<b>31-008-001</b>	STRAIGHT
<b>31-008-002</b>	CURVED
<b>31-008-003</b>	STRAIGHT, 1X2 TEETH
<b>31-008-004</b>	CURVED, 1X2 TEETH





**COLLIER NEEDLE HOLDER**

Item Code	Description
<b>32-001-001</b>	13 cm/ 5 1/8"

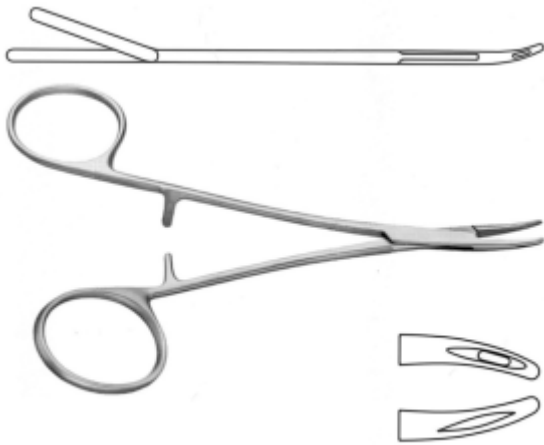

**CONVERSE NEEDLE HOLDER**

Item Code	Description
<b>32-002-001</b>	15 cm/ 6"

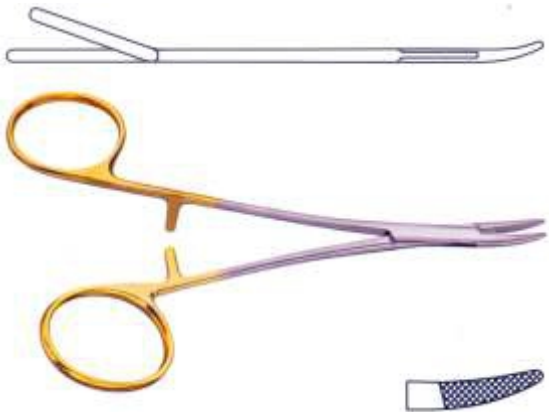

**CONVERSE NEEDLE HOLDER**

Item Code	Description
<b>32-003-001</b>	TC, 15 cm/ 6"

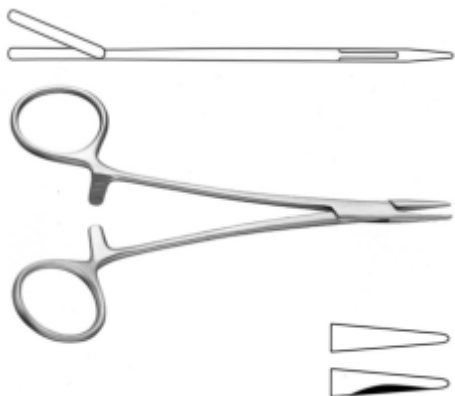

**NEIVERT NEEDLE HOLDER**

Item Code	Description
<b>32-004-001</b>	12 cm/ 5"



**NEEDLE HOLDER, TC**

Item Code	Description
<b>32-005-001</b>	11.5 cm/ 4½"
<b>32-005-002</b>	13 cm/ 5 1/8"



**NEIVERT NEEDLE HOLDER**

Item Code	Description
<b>32-006-001</b>	TC, 12.5 cm/ 5"



**WRIGHT (DERF) NEEDLE HOLDER**

Item Code	Description
<b>32-007-001</b>	12.5 cm/ 5"



**NEEDLE HOLDER**

Item Code	Description
<b>32-008-001</b>	TC, 12.5 cm/ 5"



**WRIGHT (DERF) NEEDLE HOLDER**

Item Code	Description
<b>32-009-001</b>	TC, 12.5 cm/ 5"



**HALSEY NEEDLE HOLDER**

Item Code	Description
<b>32-010-001</b>	13.5 cm/ 5 3/8"



**HALSEY NEEDLE HOLDER**

Item Code	Description
<b>32-011-001</b>	TC, 13.5 cm/ 5 3/8"

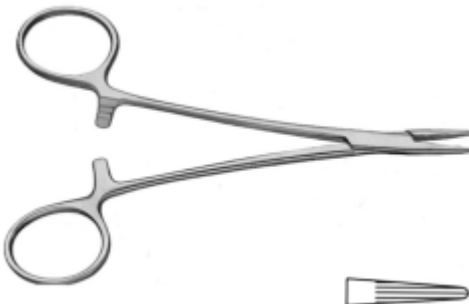

**DERF CONVERSE NEEDLE HOLDER**

Item Code	Description
<b>32-012-001</b>	12.5 cm/ 5"



**CRILE WOOD NEEDLE HOLDER**

Item Code	Description
<b>32-013-001</b>	15 cm/ 6"
<b>32-013-002</b>	18 cm/ 7 1/8"
<b>32-013-003</b>	20 cm/ 8"
<b>32-013-004</b>	23 cm/ 9"



**CRILE WOOD NEEDLE HOLDER, TC**

Item Code	Description
<b>32-014-001</b>	15 cm/ 6"
<b>32-014-002</b>	18 cm/ 7 1/8"
<b>32-014-003</b>	20 cm/ 8"
<b>32-014-004</b>	23 cm/ 9"
<b>32-014-005</b>	25 cm/ 10"
<b>32-014-006</b>	30 cm/ 11 3/4"

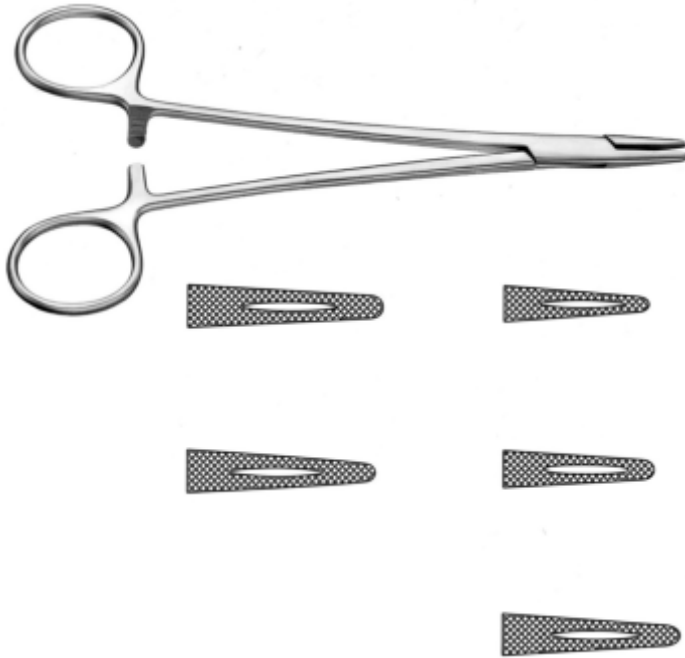

**MAYO HEGAR NEEDLE HOLDER**

Item Code	Description
<b>32-015-001</b>	15 cm/ 6"
<b>32-015-002</b>	18 cm/ 7 1/8"
<b>32-015-003</b>	23 cm/ 9"
<b>32-015-004</b>	24 cm/ 9 1/2"

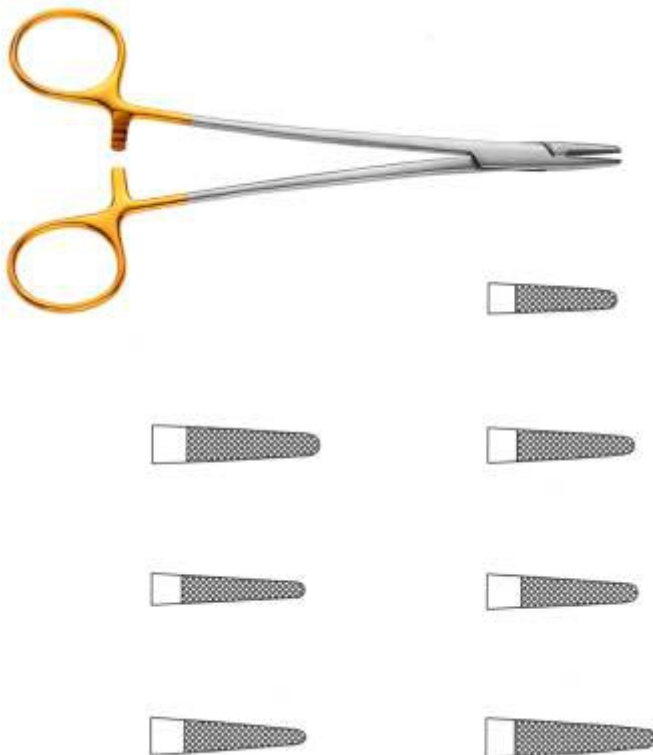

**MAYO HEGAR NEEDLE HOLDER, TC**

Item Code	Description
<b>32-016-001</b>	15 cm/ 6"
<b>32-016-002</b>	18 cm/ 7 1/8"
<b>32-016-003</b>	23 cm/ 9"
<b>32-016-004</b>	24 cm/ 9 1/2"
<b>32-016-005</b>	26 cm/ 10 1/4"
<b>32-016-006</b>	30 cm/ 11 3/4"

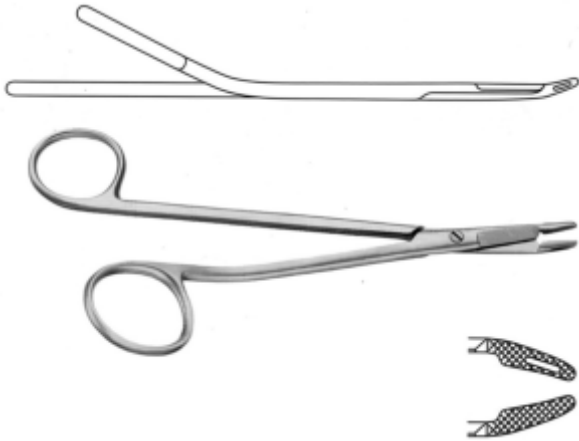

**GILLIES SLIM NEEDLE HOLDER**

Item Code	Description
<b>32-017-001</b>	14.5 cm/ 5¾"

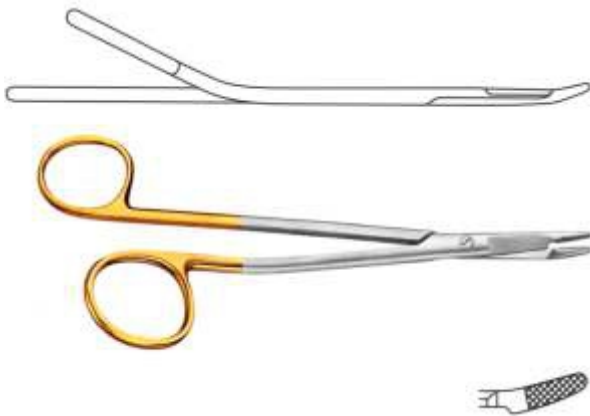

**GILLIES SLIM NEEDLE HOLDER, TC**

Item Code	Description
<b>32-018-001</b>	14.5 cm/ 5¾"



**GILLIES NEEDLE HOLDER**

Item Code	Description
<b>32-019-001</b>	15.5 cm/ 6 1/8"



**VESSEL DILATOR**

Item Code	Description
<b>33-001-001</b>	ANGLED, 11cm/ 4 <sup>1</sup> / <sub>4</sub> ", 0.2mmØ



**VESSEL DILATOR**

Item Code	Description
<b>33-002-001</b>	ANGLED, 11cm/ 4 <sup>1</sup> / <sub>4</sub> ", 0.3mmØ



**VESSEL DILATOR**

Item Code	Description
<b>33-003-001</b>	ANGLED, 13.5cm/ 5 3/8", 0.2mmØ



**VESSEL DILATOR**

Item Code	Description
<b>33-004-001</b>	LONG ANGLED, 13.5cm/ 5 3/8", 0.2mmØ



**VESSEL DILATOR**

Item Code	Description
<b>33-005-001</b>	LONG ANGLED, 18cm/ 7", .3mmØ



**VESSEL DILATOR**

Item Code	Description
<b>33-006-001</b>	LONG ANGLED, 18cm/ 7", 0.2mmØ



**ROUND BODIED VESSEL DILATOR**

Item Code	Description
<b>33-007-001</b>	15cm/ 6", 0.3mmØ, BALANCED FORCEPS



**ROUND BODIED VESSEL DILATOR**

Item Code	Description
<b>33-008-001</b>	CURVED, 15cm/ 6", 0.2mmØ, BALANCED FORCEPS



**ROUND BODIED VESSEL DILATOR**

Item Code	Description
<b>33-009-001</b>	18cm/ 7", 0.3mmØ, BALANCED FORCEPS



**ROUND BODIED VESSEL DILATOR**

Item Code	Description
<b>33-010-001</b>	CURVED, 18cm/ 7", 0.3mmØ, BALANCED FORCEPS



**JEWELLERS FORCEPS**

Item Code	Description
<b>33-011-001</b>	11cm/ 4¼", 0.3mmØ



**JEWELLERS FORCEPS**

Item Code	Description
<b>33-012-001</b>	LONG, 15cm/ 6", 0.3mmØ



**JEWELLERS FORCEPS**

Item Code	Description
<b>33-013-001</b>	12cm/ 4¾", 0.3mmØ





**JEWELLERS FORCEPS**

Item Code	Description
<b>33-014-001</b>	13.5cm/ 5 3/8", 0.3mmØ



Pierse Forceps have a micro hole in the tips which securely grip tissue with minimal trauma



**PIERSE FORCEPS**

Item Code	Description
<b>33-015-001</b>	12cm/ 4 3/4", 0.3mmØ



**MICRO ADSON FIXATION FORCEPS**

Item Code	Description
<b>33-016-001</b>	12cm/ 4 3/4", 0.3mmØ, 1X2 MICRO TEETH



**ROUND BODIED FORCEPS**

Item Code	Description
<b>33-017-001</b>	15cm/ 6", STRAIGHT, WITH PLATFORM, 0.3mmØ



**ROUND BODIED FORCEPS**

Item Code	Description
<b>33-018-001</b>	15cm/ 6", CURVED, WITH PLATFORM, 0.3mmØ



**ROUND BODIED FORCEPS**

Item Code	Description
<b>33-019-001</b>	15cm/ 6", ANGLED, 0.2mmØ



**ROUND BODIED FORCEPS**

Item Code	Description
<b>33-020-001</b>	18cm/ 7", STRAIGHT, 0.5mmØ



**Abdomino Plasty (Tummy Tuck ) Set Detail:**

- Knife Handle No. 3
- Halsted Mosquito Forceps, curved
- Mayo-Hegar Needle Holder, TC
- Webster Needle Holder, TC, smooth jaws
- Adson Tissue Forceps, 1 x 2 teeth & Cross Serrated
- Joseph Hook, sharp
- Mayo Scissors, straight
- Gorney Freeman Scissors, SC, curved
- Metzenbaum Scissors, SC, curved
- Stevens Tenotomy Scissors, SC, curved
- Lahey Forceps, 3 x 3 teeth
- Allis Tissue Forceps, 5 x 6 teeth
- Brown-Adson Forceps, 9 x 9 teeth
- US Army Retractor, 2/set
- Tissue Forceps, 1 x 2 teeth
- Iris Scissors, TC, straight
- Yancoskie Retractor, 6 prongs
- Freeman Retractor, 4 prongs, 22mm
- Freeman Retractor, 4 prongs, 38mm
- Meyerding Retractor, large
- Lockwood Abdominal Demarcator



**ABDOMINOPLASTY SET, Consisting of;**

- Scalpel blades #15
- Scalpel blades #21
- Scalpel handle, #7
- Scalpel handle, #4l long
- Ragnell kilner scissors, 13cm, curved - flattened at distal end
- Adson delicate tissue and suture forceps, 15cm, 1x2 teeth
- Adson brown delicate tissue forceps, 12cm, 9x9 teeth, straight - atraumatic
- Potts smith tissue forceps, 20cm, 1x2 teeth - delicate
- Allis Tissue Forcep 5X6 teeth, 16cm
- Wright derf t.c. needle holder, 12.5cm, serrated
- Mayo hegar t.c. needle holder, 15cm
- Mayo hegar t.c. needle holder, 23cm
- Backhaus towel clamp, 8.5cm
- Joseph skin hook, double prong, sharp, 16cm, 10mm wide
- Stevens Supercut Tenotomy Scissors, 10.5cm, Curved, Blunt - Delicate
- Supercut mayo scissors, 14cm, straight
- Supercut gorney scissors, 23cm, curved
- Supercut gorney freeman scissors, 23cm, curved "gold tip"
- Supercut scissors, 20cm, curved, slight bevel on shank, "gold tip"
- Supercut scissors, 20cm, curved, strong bevel on shank
- Farabeuf baby retractors, 12cm, double ended, set of 2
- Israel retractor, 25cm, 6 blunt prongs, 60mm wide x 50mm deep
- Saldanha solz abdominal retractor, 37cm



**BLEPHAROPLASTY SET Consisting of:**

- Scalpel Handle, #3 Standard
- Stevens Scissors, 11.5cm, Curved - Sharp
- Stevens Scissors, 11.5cm, Curved - Blunt
- Neivert Needle Holder, 12.5cm
- Halsted Mosquito Forceps, 12.5cm, Curved
- Backhaus Towel Clamp, 8.5cm
- Gillies Dura And Skin Retractor Hook, 19cm, Small
- Joseph Delicate Retractor, 17cm, 2 Prong, 5mm, Sharp
- Joseph Delicate Tracheal Retractor, 16cm, 2 Prong, 8mm, Blunt
- Supercut Mayo Scissors, 14cm, Straight
- Desmarres Lid Retractor #1, 14cm, Small, 9x12mm
- Castroviejo Measuring guage 7 cm, Measuring Guage 20 mm,
- Bishop Harmon Iris Forceps, 1X2 teeth, 0.3 mm
- Castroviejo Suturing Forceps, 1X2 teeth, 0.9 mm



**Breast Augmentation Set :**

- |   |  |
|---|--|
| Knife Handle No. #3   | Webster Needle Holder, TC, smooth jaws |
| Halsted Mosquito Forceps, curved                            | Halsey Needle Holder, TC, smooth jaws  |
| Metzenbaum Scissors, SC, curved                             | McKissock Mammoplasty Caliper          |
| Gorney Freeman Scissors, SC, curved                         | Flexible Ruler                         |
| Mayo Scissors, straight                                     | Spatula Breast Dissector               |
| Iris Scissors, TC, straight                                 | Walther Sound 32FR                     |
| Yankauer Suction Tube                                       | Silverstein Breast Dissector           |
| Frazier Suction Tube, 12 FR                                 | Joseph Hook, sharp                     |
| Adson Dressing Forceps                                      | Senn Retractor, sharp                  |
| Adson Tissue & Suture Forceps, 1 x 2 teeth w/tying platform | US Army Retractor, 2/set               |
| Brown-Adson Forceps, 9 x 9 teeth                            | Freeman Retractor, 4 prong, 38mm       |
| Tissue Forceps, 1 x 2 teeth                                 | Pediatric Ribbon Retractor, malleable  |
| Dressing Forceps, serrated                                  | Ferreira Fiber Optic Retractor         |
| Freeman Areola Marker, 38mm                                 | Deaver Fiber Optic Retractor           |
| Freeman Areola Marker, 42mm                                 | TBTS Fiber Optic Retractor, with teeth |
| Freeman Areola Marker, 45mm                                 |  |
| Freeman Areola Marker, 50mm                                 |  |
| McKissock Breast Marker, 38mm, Keyhole pattern              |  |
| McKissock Breast Marker, 42mm, Keyhole pattern              |  |
| McKissock Breast Marker, 45mm, Keyhole pattern              |  |
| Mayo-Hegar Needle Holder, TC                                |  |

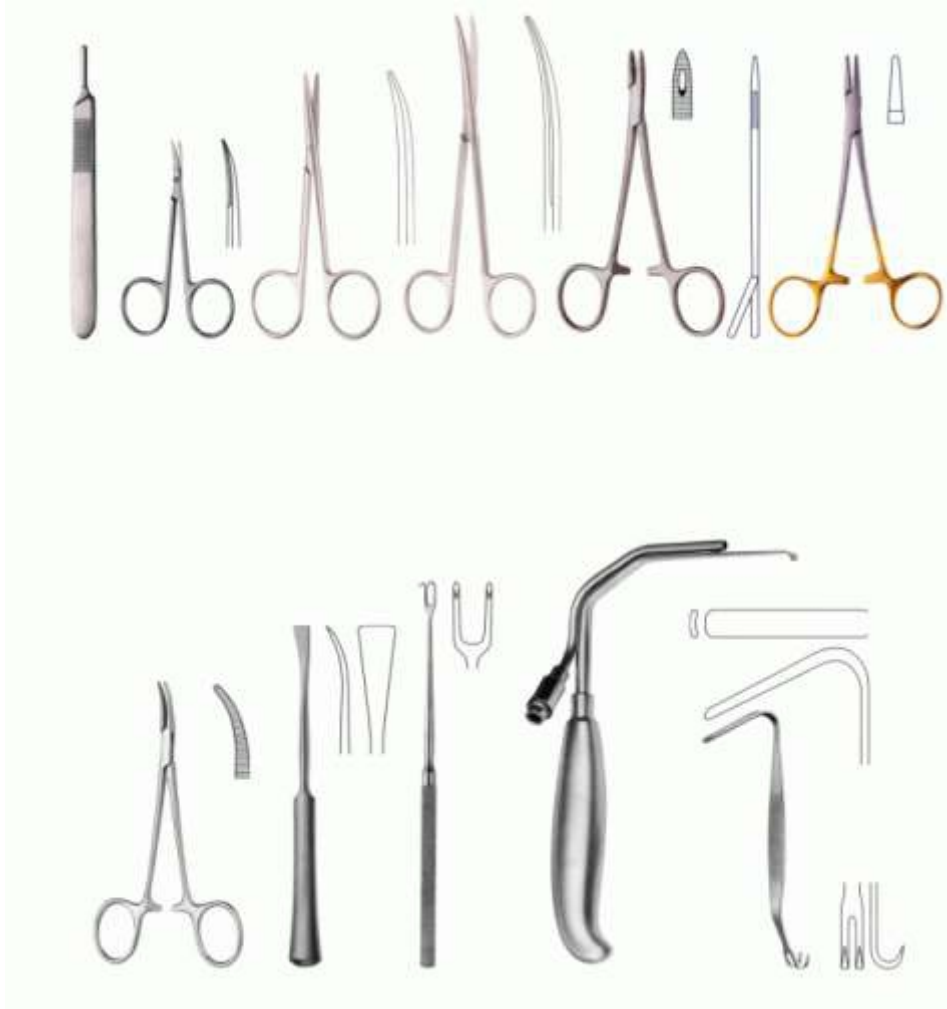

**Chin Augmentation Set (Walter Set), Consisting of;**

- Scalpel Handle, #3 Standard
- Micro Iris Scissors, 9cm, Curved - Delicate
- Baby Metzenbaum T.C. Scissors, 11.5cm, Curved
- Metzenbaum T.C. Scissors, 14cm, Curved
- Collier Needle Holder, 13cm
- Neivert T.C. Needle Holder, 12.5cm, Smooth
- Halsted Mosquito Forceps, 12.5cm, Curved
- Joseph Skin Hook, Double Prong, Sharp, 16cm, 7mm Wide
- Walter Bone Elevator, 14.5cm, 8mm, Curved
- Walter Raspatory, 14.5cm, 8mm, Curved
- Walter Alar And Nasal Retractor With Fiber Optic Illumination, 18.5cm
- Aufricht Walter Nasal Retractor, 13.5cm, Double Ended, Sharp, 42x7mm
- Aufricht Walter Nasal Retractor, 13.5cm, Double Ended, Blunt, 38x7mm

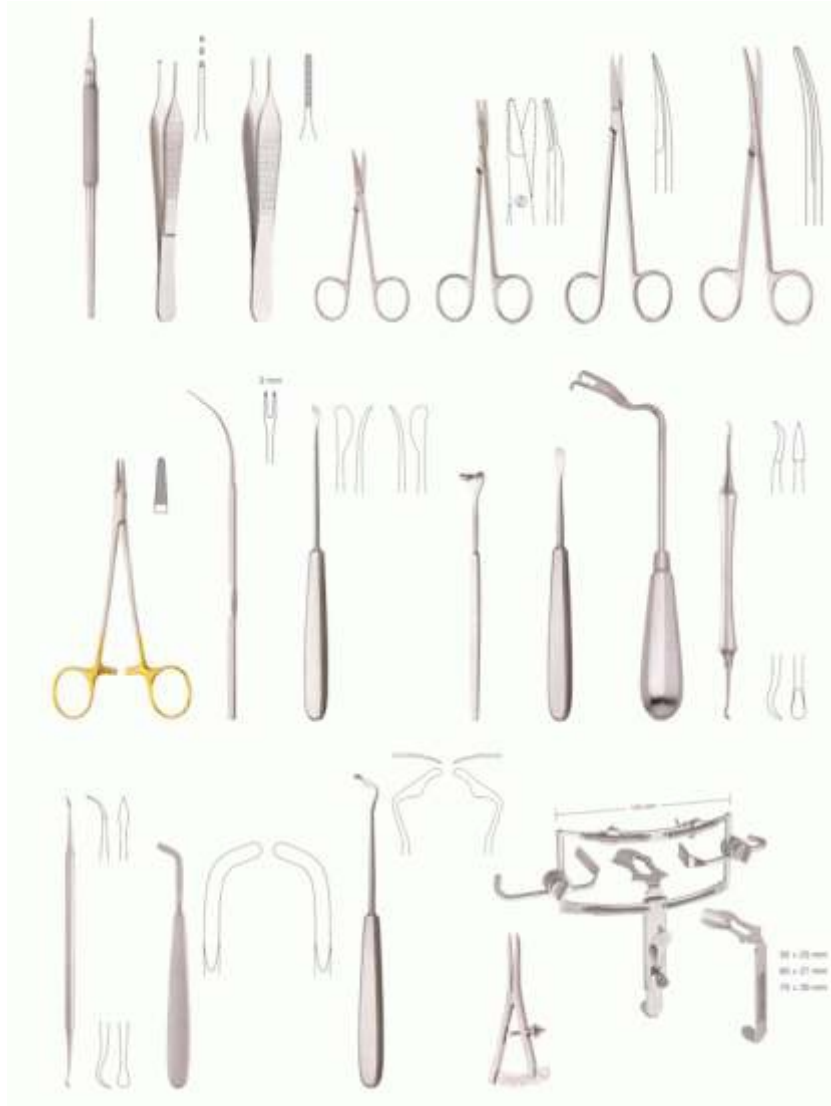

### **Cleft & Palate Repairing Instruments Set,**

- Scalpel, Round Handle, 16cm
- Adson Forceps, 15cm, Serrated
- Adson Forceps, 15cm, 1x2 Teeth
- Iris Supercut Scissors, 11.5cm, Curved
- Iris Supercut Scissors, 11.5cm, Curved
- Ragnell Kilner Scissors, 13cm, Curved
- Supercut Plus Kelly T.C. Scissors, 16cm, Curved
- Metzenbaum T.C. Scissors, 18cm, Curved
- Crile Wood T.C. Needle Holder, 15cm
- Blocksma Cleft Palate Hook, 18cm, 3mm, 2 Prong
- Cleft Palate Raspatory, 14cm, #1 Left
- Cleft Palate Raspatory, 14cm, #2 Right
- Kahre Cleft Palate Raspatory, 17cm
- Mcindoe Cleft Palate Raspatory, 16.5cm
- Muco-Periosteal Retractor, 19cm
- Wang Cleft Palate Elevator, 15.5cm
- Wang Cleft Palate Elevator, 18cm, Right
- Wang Cleft Palate Elevator, 18cm, Left
- Wang Cleft Palate Elevator, 18cm, Right Angled
- Wang Cleft Palate Elevator, 18cm, Left Angled
- Castroviejo Caliper, 7cm, 20mm Measuring Range
- Dingman Mouth Gag, Complete

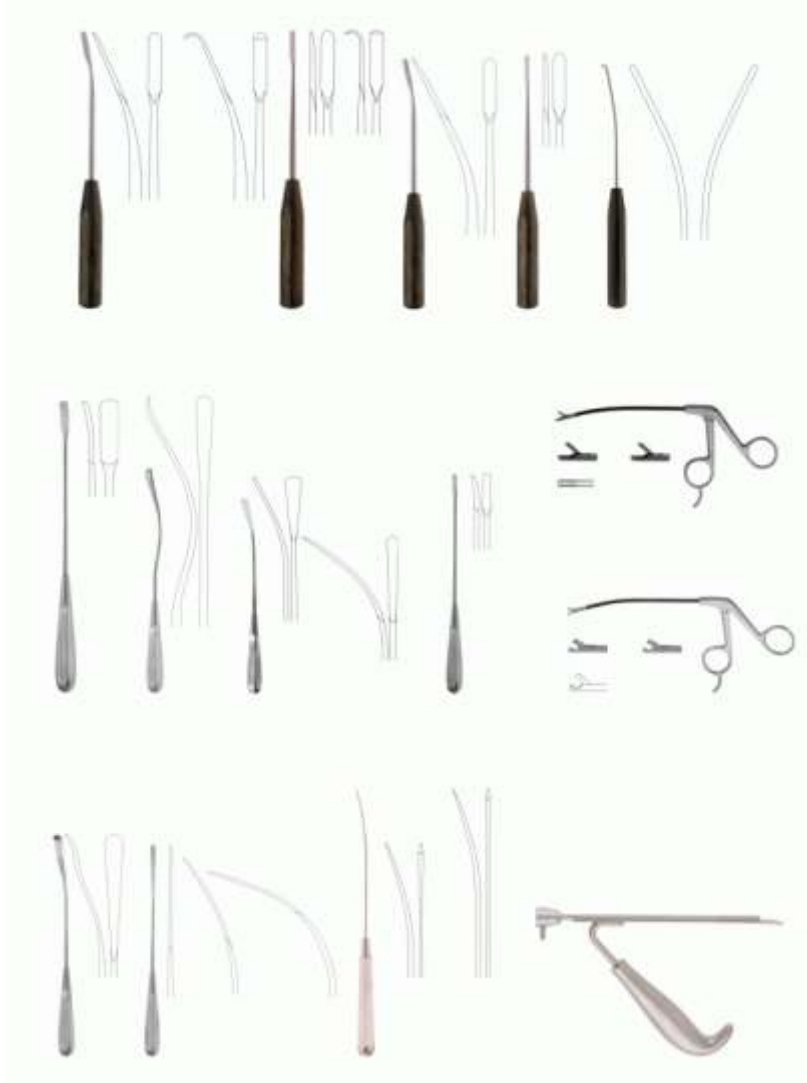

**Endoscopic Face Lift Set, Consisting of;**

- Retractor With Channel For Endoscope, 20cm
- Endo Facelift Raspatory, 25cm, 6mm, Straight
- Endo Facelift Raspatory, 25cm, 6mm, Curved
- Endo Facelift Raspatory, 25cm, 6mm, Straight
- Endo Facelift Raspatory, 25cm, 6mm, Curved
- Endo Facelift Dissector, 25cm, 6mm, Blunt, Straight
- Endo Facelift Dissector, 25cm, 6mm, Blunt, Curved
- Endo Facelift Nerve Hook, 20cm, Curved Left
- Endo Facelift Nerve Hook, 20cm, Curved Right
- Hook Scissors, 12cm Working Length, Curved Left
- Hook Scissors, 12cm Working Length, Curved Right
- Grasping Forceps, 12cm Working Length, Curved Left
- Grasping Forceps, 12cm Working Length, Curved Right
- Endo Facelift Periosteal Elevator, 27cm, 9mm, S Curved
- Endo Facelift Dissector, 27.5cm, 11mm
- Endo Facelift Elevator, 27.5cm, 4mm
- Endo Facelift Dissector, 27.5cm, 9mm
- Endo Facelift Tissue Elevator, 27.5cm, 12mm, Slight Curve
- Endo Facelift Elevator, 25.5cm, 8mm, Half Curve
- Endo Facelift Elevator, 28cm, 8mm, Straight
- Endo Facelift Elevator, 27cm, 8mm, Slight Curve
- Endo Facelift Elevator, 24cm, 8mm, Strong Curve
- Endo Facelift Elevator With Suction, 27.5cm, 7mm



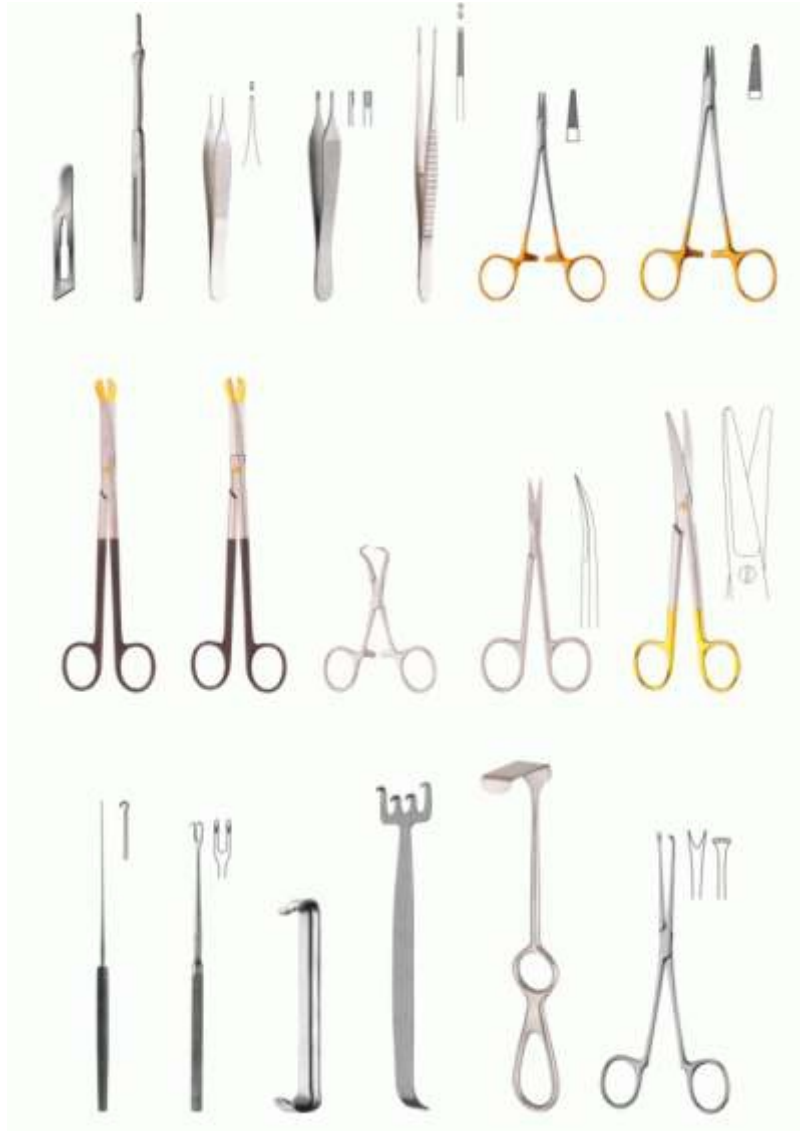

**Face & Forehead Lift Set, Consisting of;**

Scalpel Blades #15 - Sterile, 100/Box

Scalpel Handle, #7

Micro Adson Forceps, 12cm, 1x2 Teeth - 0.8mm Tips

Adson Brown Delicate Tissue Forceps, 12cm,

Select Tissue Forceps, 20cm, 1x2 Teeth - Extremely Fine

Gubisch T.C. Needle Holder, 12.5cm, Extra Fine

Baby Crile Wood T.C. Needle Holder, 15cm

Backhaus Towel Clamp, 8.5cm

Gillies Dura And Skin Retractor Hook, 19cm, Small

Joseph Delicate Retractor, 17cm, 2 Prong, 5mm, Sharp

Iris Supercut Scissors, 12.5cm, Curved

Supercut Mayo Scissors, 14cm, Straight

Gold Tip Supercut Scissors, 20cm, Curved, Slight Bevel On Shank

Gold Tip Supercut Scissors, 20cm, Curved, Strong Bevel On Shank

Farabeuf Baby Retractors, 12cm,

Walter Retractor, 19cm, 4 Prongs,

Langenbeck Kocher Retractor #13, 15 X 80mm

Solz Racket Retractor, 12.5cm, 45x100mm

Pitanguy Facelift Marker, 16cm, 5mm Wide



**Forehead Lift and Facial Implant Set Detail :**

Siegel Knife Handle  
Flexible Ruler  
Halsted Mosquito Forceps, curved  
Adson Hemostatic Forceps, curved  
Allis Tissue Forceps, 4 x 5 teeth  
Frazier Suction Tube, 10 FR  
Yankauer Suction Tube  
Gorney Freeman Scissors, SC, curved  
Metzenbaum, straight  
Iris Scissors, TC, straight  
Adson Dressing Forceps, serrated  
Adson Tissue & Suture Forceps, 1 x 2 teeth  
Brown-Adson Forceps, 9 x 9 teeth  
Bayonet Bipolar Forceps, 1.0 mm tips  
Cushing Tissue Forceps, Bayonet, 1 x 2 teeth  
Mayo-Hegar Needle Holder, TC  
Crile-Wood Needle Holder, TC, smooth jaws  
Joseph Double Hook, sharp

Gillies Skin Hook  
US Army Retractor, 2/set  
University of Minnesota Cheek Retractor  
D'Assumpcao Face Lift Marker  
Ferreira Fiber Optic Retractor  
Aufrecht Fiber Optic Retractor  
Deaver Fiber Optic Retractor, 5/8"  
Deaver Fiber Optic Retractor, 1"  
#9 Molt Elevator  
Tessier Periosteal Elevator, 6 mm Wide  
Tessier Periosteal Elevator, 7 mm Wide  
Tessier Periosteal Elevator, 9 mm Wide  
Scalp Elevator Dissector, curved, 7 mm  
Frontotemporal Dissector, curved, 7 mm  
Frontotemporal Dissector, straight, 10 mm  
Corrugator and Procerus Muscle Dissector, S-shaped, 5 mm



### **RHINOPLASTY INSTRUMENTS**

- Aiach-Gubisch cartilage forceps 16CM
- COTTLE GUBISCH CHISEL, 18CM, 5MM, GRADUATED, HOLLOW CUT
- GUBISCH FANOUS NASAL OSTEOTOME, 19.5CM, NARROW, DELICATE, WITH GUIDE THORN
- GUBISCH AUFRICHT NASAL RETRACTOR, 17CM, 50X6-12MM
- GUBISCH CARTILAGE CRUSHER, 65X30MM
- GUBISCH FOMON T.C. NASAL RASP, 20CM
- GUBISCH KILNER DOUBLE NASAL HOOK (ALAR RETRACTOR), 8CM, SHARP, 5X10MM
- GUBISCH OSTEOTOME, 18.5CM, 3MM, ALUMINIUM HANDLE
- SUCTION RASPARTORY WITH GUIDE, 20CM, 4MM
- GUBISCH T.C. NEEDLE HOLDER, 12.5CM, EXTRA FINE
- Gubisch-Rubin Tungsten Carbide septal morseliser forceps



### **MAMMAPLASTY SET**

Scalpel Blades #15 - Sterile, 100/Box

Scalpel Handle, #7

Jabeley Scissors, 13cm, Curved - Sharp/Sharp

Metzenbaum Scissors, 20cm, Curved - Standard Pattern

Micro Adson Forceps, 12cm, 1x2 Teeth - 0.8mm Tips

Gruenwald Nasal Bayonet Forceps, 19.5cm, Serrated Tips

Baby Crile Wood Needle Holder, 15cm

Baby Crile Wood T.C. Needle Holder, 15cm

Jabeley Supercut Scissors, 13cm, Curved - Sharp/Sharp

"Gold Tip" Supercut Scissors, 20cm, Curved, Slight Bevel On Shank

Solz "Gold Tip" Supercut Scissors, 20cm, Curved, Strong Bevel On Shank

Farabeuf Baby Retractors, 12cm, Double Ended, Set Of 2

Langenbeck Kocher Retractor #13, 15mm Wide X 80mm Deep, 21cm

Atraumatic Breast Dissector, 34cm

Breast Hook Dissector, Curved to Left 36cm

Breast Hook Dissector, Curved to Right 36cm

Areola Marker, Blunt, 36mm Diameter

Areola Marker, Blunt, 40mm Diameter

Areola Marker, Blunt, 42mm Diameter

Areola Marker, Blunt, 45mm Diameter

Marx Breast Retractor, 27cm, 125 X 30mm

Round Bowl For Solutions/Marking Color, 60x30mm, 60cc

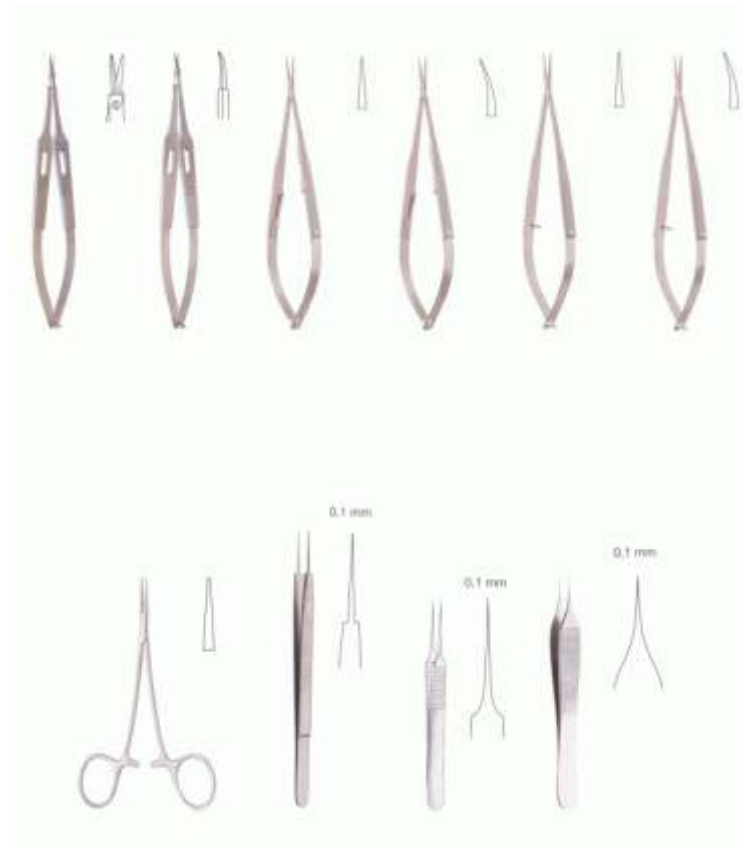

**Micro Surgical Instruments Set, Consisting of;**

- Micro Vannas Scissors, 15cm, Curved, Ultra Fine
- Micro Vannas Scissors, 15cm, Straight, Ultra Fine
- Ultra Fine Micro Forceps, 11cm
- Ultra Fine Micro Forceps, 14cm
- Jacobson Adson Koshima Ultra Fine Forceps, 12cm
- Castroviejo Ultra Fine Needle Holder, 14.5cm, Straight
- Castroviejo Ultra Fine Needle Holder, 14.5cm, Curved
- Castroviejo Ultra Fine Needle Holder, 14.5cm, Straight
- Castroviejo Ultra Fine Needle Holder, 14.5cm, Curved
- Jacobson Micro Mosquito Forceps, 12.5cm, Straight



**RhinoPlasty Instruments Set ( Walter Set ), Consisting of;**

Scalpel Handle, #7k,  
 Surgical Operating Scissors, 14.5cm, Curved - Sharp/Blunt  
 Ragnell Kilner Scissors, 15cm, Curved - Flattened At Distal End  
 Fox T.C. Gum And Tissue Scissors, 13cm, Curved, 1 Serrated Blade  
 Adson Brown Delicate Tissue Forceps, 12cm, 7x7 Teeth, Straight  
 Adson Brown Delicate Tissue Forceps, 12cm, 9x9 Teeth, Straight  
 Semken Delicate Tissue Forceps, 12.5cm, 2x3 Teeth, Straight  
 Debakey At Vascular Forceps, 15cm - 1.5mm Tips  
 Bayonet Grasping Forceps, 16cm  
 Bayonet Grasping Forceps, 16cm, 1x1 Teeth  
 Troeltsch Wilde Angular Forceps, 13cm, Adult Size - Serrated  
 Grooved Director And Tongue Tie, 11.5cm  
 Frazier Fergusson Suction Tube, 18cm, Angled, 10 French e  
 Senning T.C. Needle Holder, 17cm, Serrated  
 Halsted Micro Mosquito Forceps, 12.5cm, Curved  
 Backhaus Towel Clamp, 8.5cm  
 Gross Dressing Forceps, 20cm, Straight - Without Catch, Box Lock  
 Walter Cope Retractor, 17.5cm  
 Joseph Skin Hook, 16cm, Single Prong, Sharp  
 Guthrie Double Retractor Hook, 13cm, 2mm Wide, Sharp  
 Lempert Raspatory, 17cm, 4mm, Delicate, Sharp  
 Supercut Walter Dorsal Scissors, 14cm, Angular  
 Supercut Walter Cottle Dorsal Scissors, 16cm, Curved  
 Medicon Mallet, 18.5cm, Plastic Facings, 200 Grams, 25mm Diameter  
 Walter Williger Bone Curette, 13.5cm, 2/2mm, Double Ended, Sharp, Angled  
 Defourmentel Bone Rongeur, 19cm, Straight, Slender Beaks - Jaws 3mm Wide  
 Weil Blakesley Wilde Ethmoid Bone Forceps #3, 120mm Shaft, 4.2mm  
 Weil Blakesley Wilde Ethmoid Bone Forceps #2, 45 Degree Angle, 120mm Shaft, 3.6mm  
 Myles Nasal Through Cutting Forceps #4, 120mm Shaft  
 Cottle Nasal Septum Speculum, 14cm, 50mm  
 Cottle Elevator, 16cm, 2.5mm  
 Masing Septum Elevator, 22cm, 5/5mm, Double Ended  
 Aufricht Walter Nasal Retractor, 13.5cm, Double Ended, Sharp, 42x7mm  
 Aufricht Walter Nasal Retractor, 13.5cm, Double Ended, Blunt, 38x7mm  
 Walter Chisel/Osteotome, 19cm, 3mm, Modified  
 Walter Chisel/Osteotome, 19cm, 5mm, Modified  
 Walter Osteotome, 19cm, 2mm, Straight  
 Walter Osteotome, 19cm, 12mm, Straight  
 Walter Chisel/Osteotome, 19cm, 12mm, Modified  
 Walter Osteotome, 19cm, 6mm, Curved  
 Walter Cantanares Lifting Scissors, 16cm, Curved  
 Fomon Rhinoplasty Scissors, 12.5cm  
 Cottle Columella Forceps, 11cm  
 Fomon Bone And Nasal Rasp, 20cm  
 Asch Septum Straightening Forceps, 22cm, Angled  
 Brunings Tongue Depressor, 19cm, 14mm

**RHINOPLASTY INSTRUMENTS SET (Gubisch Set), Consisting of;**





### **RHINOPLASTY INSTRUMENTS SET (Gubisch Set), Consisting of;**

Scalpel Blades #15 - Sterile,  
 Scalpel Handle, #7  
 Surgical Operating Scissors, 13cm, Straight - Sharp/Blunt  
 Mayo Stille T.C. Operating Scissors, 17cm, Curved  
 Reynolds Jameson Scissors, 14cm, Curved - With Fine, Rounded Points  
 Adson T.C. Tissue Forceps, 12cm  
 Micro Adson Forceps, 12cm, 1x2 Teeth - 0.8mm Tips  
 Adson Brown Delicate Tissue Forceps, 12cm, 7x7 Teeth, Straight - Atraumatic  
 Dressing Forceps, 20cm - Modified Swedish Pattern  
 Nelson Tissue Forceps, 15cm  
 Gruenwald Jansen Nasal Dressing Bayonet Forceps, 16cm, Serrated  
 Gubisch T.C. Needle Holder, 12.5cm, Extra Fine  
 Crile Wood T.C. Needle Holder, 15cm  
 Halsted Micro Mosquito Forceps, 12.5cm, Curved  
 Leriche Artery Forceps, 15cm, 1x2 Teeth, Straight  
 Pean Hemostatic Forceps, 14cm, Straight  
 Backhaus Towel Clamp, 13cm  
 Dressing Forceps, 17.5cm, Curved, Delicate  
 Gross Dressing Forceps, 20cm, Curved - With Catch, Box Lock  
 Barsky Skin Hook, 15cm, Single Prong, Sharp  
 Joseph Delicate Retractor, 17cm, 2 Prong, 5mm, Sharp  
 Guthrie Double Retractor Hook, 13cm, Sharp  
 Supercut Plus T.C. Mayo Scissors, 14cm, Straight  
 Supercut Plus T.C. Mayo Scissors, 17cm, Curved  
 Supercut Plus Metzenbaum T.C. Scissors, 18cm, Curved  
 Supercut Plus Kelly T.C. Scissors, 16cm, Curved  
 Langenbeck Bone Elevator, 20cm, 7mm, Blunt  
 Freer Raspatory, 19cm, 5/5mm, Double Ended, Sharp / Sharp  
 Williger Raspatory, 16cm, 5mm, Sharp  
 Mckenty Raspatory, 15cm, 4mm, Sharp, Light Curve  
 Supercut Heymann Nasal Scissors, 18cm  
 Supercut Plus Fomon T.C. Dorsal Scissors, 13cm, Angular  
 Mallet, 26cm, Novotex Plastic, 240 Grams, 45mm Diameter  
 Round Bowl For Solutions, 40x20mm, 20cc  
 Round Bowl For Solutions/Marking Color, 60x30mm, 60cc  
 Round Bowl For Solutions, 80x40mm, 160cc  
 Round Bowl For Solutions, 110x55mm, 400cc  
 Castroviejo Caliper, 7cm, 20mm Measuring Range  
 Desmarres Lid Retractor #2, 14cm, Medium, 10x14mm  
 Killian Asept Nasal Speculum, #4, 90mm (Modified)  
 Weil Blakesley Wilde Ethmoid Bone Forceps #3, 120mm Shaft, 4.2mm  
 Freer Septum Knife (Mucosa Scalpel), 16cm  
 Cottle Nasal Speculum, Delicate, 15cm, 55mm  
 Gubisch Suction Raspatory With Guide And Bypass Hole, 20cm, 4mm  
 Gubisch Suction Raspatory With Guide, 17cm, 4mm  
 Cartilage Cutting Block, Teflon, 85x55x10mm  
 Gubisch Cartilage Crusher, 65x30mm  
 Gubisch Kilner Double Nasal Hook (Alar Retractor), 8cm, Sharp, 5x10mm  
 Gubisch Aufricht Nasal Retractor, 17cm, 50x6-12mm  
 Cottle Gubisch Chisel, 18cm, 5mm, Graduated, Hollow Cut  
 Cottle Gubisch Chisel, 18cm, 12mm, Graduated, Hollow Cut  
 Gubisch Osteotome, 18.5cm, 3mm, Aluminium Handle  
 Fanous Osteotome, 19.5cm, 4mm, Straight, With Guide Thorn - 1)  
 Caplan Nasal Septum Scissors, 20cm, Serrated  
 Gubisch Fomon T.C. Nasal Rasp, 20cm  
 Rubin T.C. Septal Morselizer Forceps, 20cm, With Protective Guard  
 Buchwald Tongue Spatula, 18cm, 18x23mm



**NAWROOZ  
SURGICAL**  
Quality Makes Innovation

Address: Sialkot 51040 Punjab, Pakistan.

Email: [nawroozsurgical72@gmail.com](mailto:nawroozsurgical72@gmail.com)

Contact: +92 3207987447